

BELSAW

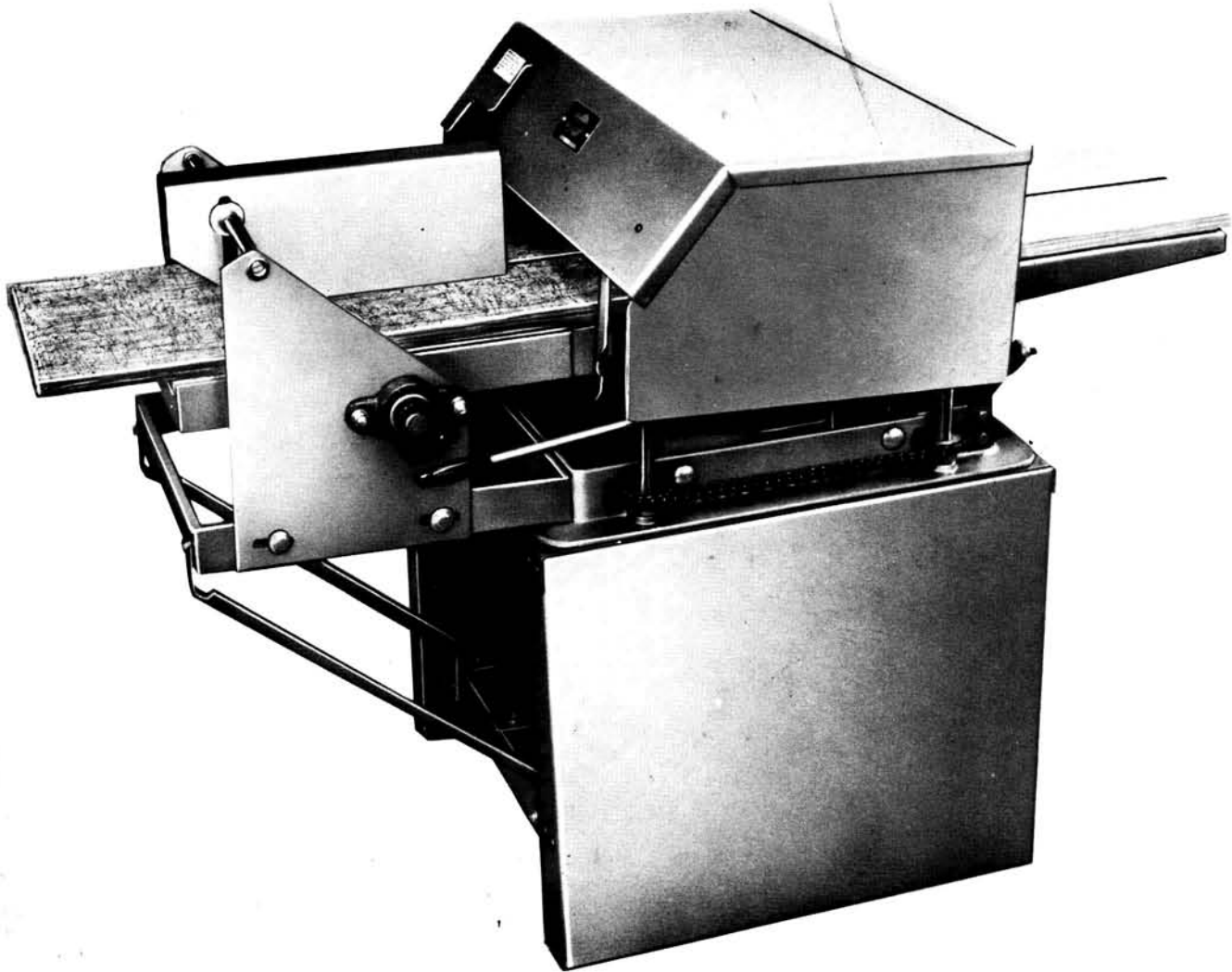

OPERATOR'S MANUAL and REPAIR PARTS LIST for PLANER MODELS 910/912



BELSAW MACHINERY CO

315 Westport Rd., Box 593 • Kansas City, Mo. 64141

Phone 816-561-9255
Cable "BELMACH"



PLANER • MOLDER • SAW - MODEL 910
THREE POWER TOOLS IN ONE

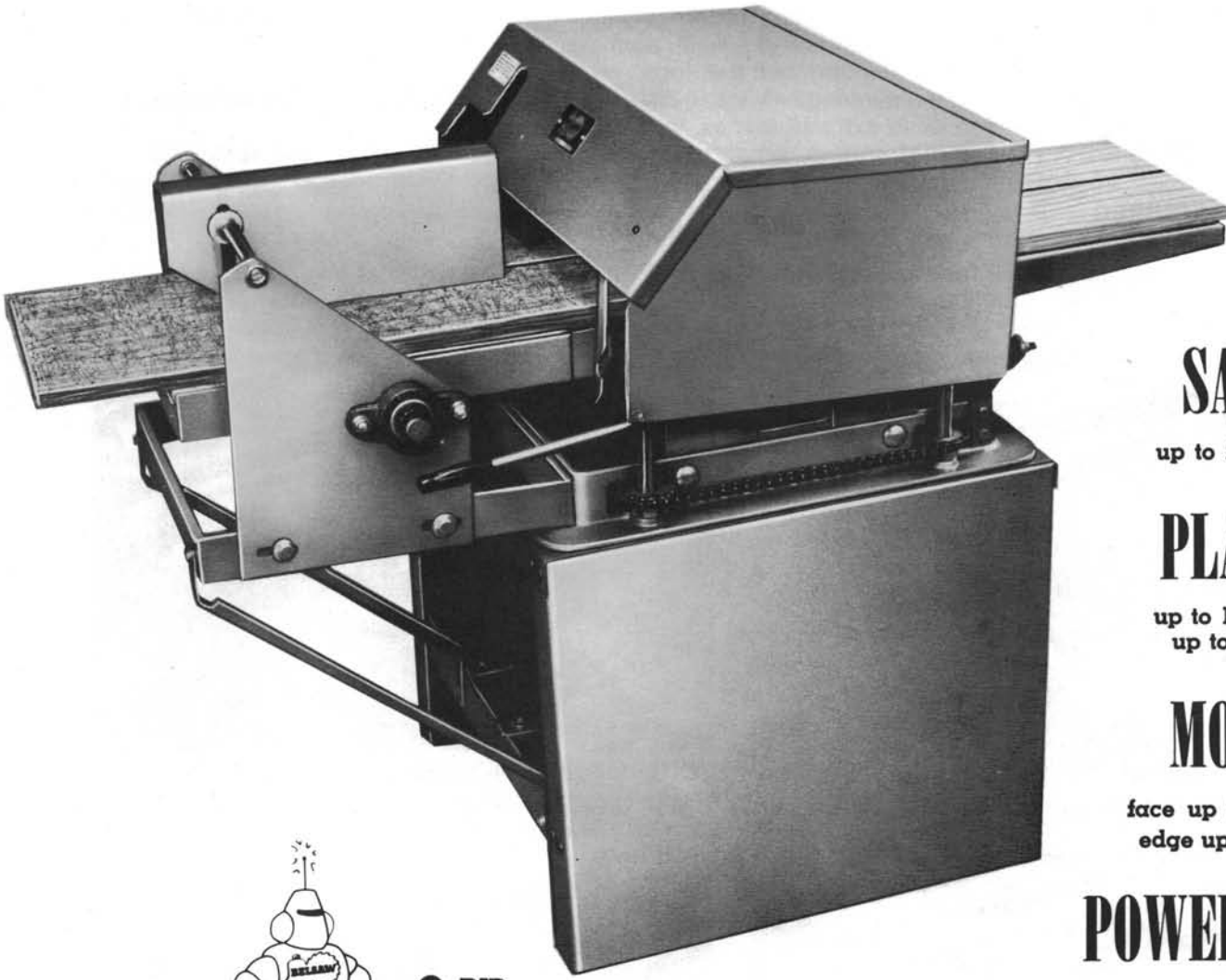

SAWS

up to 2 1/4" thick

PLANES

up to 12 1/4" wide
up to 6" thick

MOLDS

face up to 12" wide
edge up to 6" wide

POWER FEEDS

12' or 22' per minute

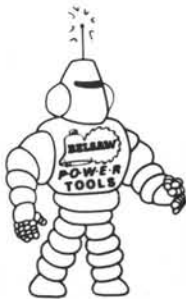

- RIP
- PLANE
- MOLD

Now you can use this ONE power-feed shop to turn rough lumber into high value moldings, trim, flooring, furniture ALL popular patterns.



315 WESTPORT ROAD, BOX 593 • KANSAS CITY, MO. 64141

Phone: 816-561-9255

Specifications

- SAWING** Maximum width 12¼-inch, maximum thickness 2¼-inch.
MOLDING Face up to 12-in. wide and edge up to 6-in. wide.
PLANING Maximum depth of cut each pass 3/16-in.
 Maximum width of cut 12¼-in.
 Maximum thickness of stock 6-in.
 Minimum thickness stock 3/16-in.
 Shortest piece (not butted) 7-in.
- FEED SPEED** Standard 12-ft. per minute, optional 22-ft. per minute.
CUTS PER INCH 80 at 4,000 R.P.M. cutterhead speed, 12-ft. feed speed.
OVERALL SIZE 24-in. wide x 46-in. long x 16-in. high.
CUTTERHEAD 3-knife solid round steel, 3/4-in. diameter.
BEARINGS 1½-in., self-aligning, ball bearings.
BED One piece machined cast iron 12¼-in. by 18-in. Saw table adds extra 16 inches, outfeed table extra 12 inches, for total of 46-inches.
BED SUPPORTS Four corner screws, synchronized with endless roller chain and sprockets. Each complete turn of control handle moves bed 1/16-in.
POWER REQUIRED ... 3 to 5 HP *(We supply 3.8-in. diameter 2-groove drive pulley. Use 9-in. diameter pulley on 1750 RPM motor or 5-in. diameter pulley on 3450 RPM motor.)*

2 HP for moderate duty, 3 to 5 HP for heavier use or faster feed.

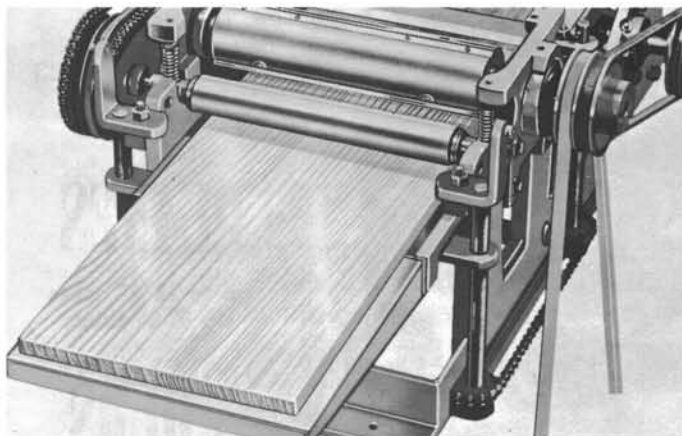

PLANING—Cutterhead uses three planer knives to surface stock up to 12¼-in. wide and up to 6-in. thick. Above photo shows a full 12-in. wide board coming out of the Belsaw surfaced on one side.

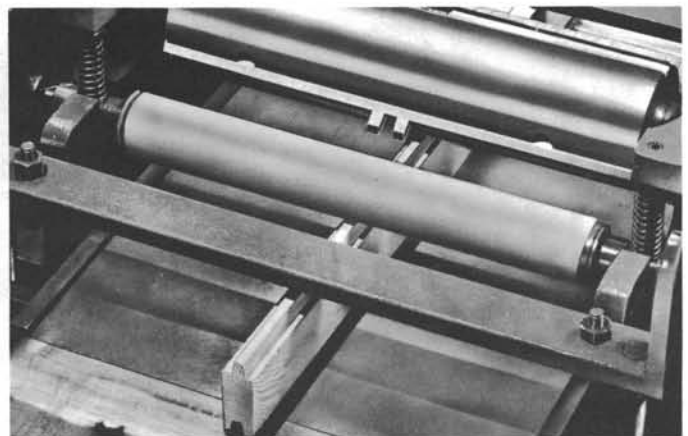

EDGE MOLDING—Tongue-and-Groove Molding is a simple operation on the new Belsaw, one of many molding operations possible by easily and quickly changing the cutters.

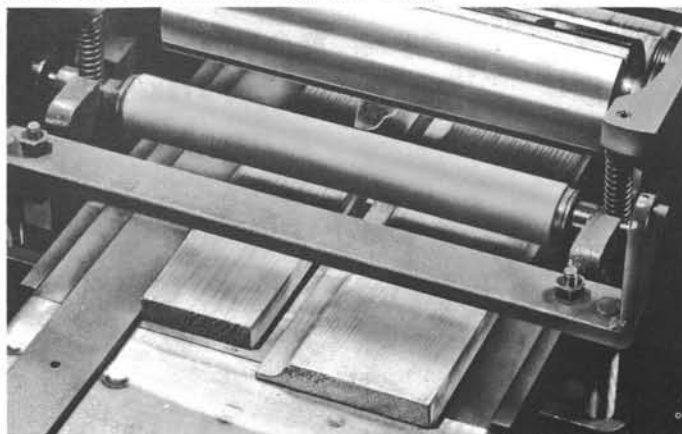

FACE MOLDING—This board is emerging from the new Belsaw, sawed to width, planed to the desired thickness and molded for baseboard use, all with power feed.

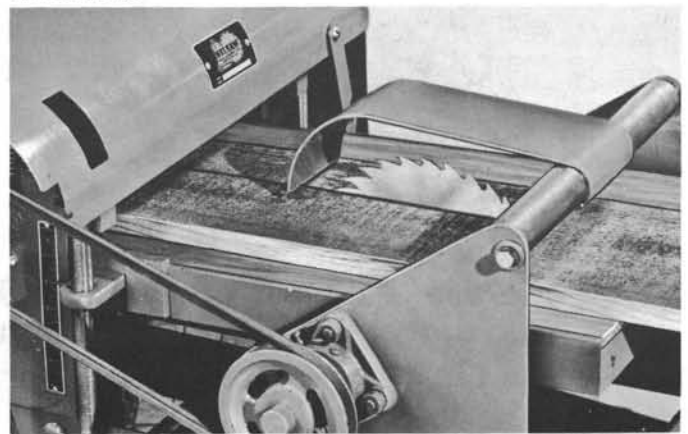

SAWING—Rip stock up to 2¼-inches thick and surface it to desired thickness and pattern in one continuous pass ... all by power feed.

SAFETY RULES

1. Use sound lumber, no loose knots, and as few tight knots as possible.
2. Before starting up after changing saw or knives, recheck to make certain all holding screws are tight.
3. Hood with its attached chipbreaker should always be DOWN, covering cutterhead when motor is on.
4. Always stop motor before making adjustments of any kind.
5. Do not stand directly in line with ANY saw or cutting knife, either behind or in front of the machine.
6. When saw blade is not in use, slide it to pulley side of arbor and remove its V-belt. Always cover blade with its guard.
7. At first sign of any trouble use #43 handle to slow feed rolls, then stop motor.
8. Use a push button motor switch mounted at position that operator can reach easily and quickly.
9. After approximately 50 feet of operation, stop machine and recheck cutterhead screws for tightness.
10. Check feed roll bearings occasionally to be sure chips are not between bearings and side castings. If bearings are not seated firmly in the casting, feed rolls will not hold stock firmly against bed and cause kick-back.
11. Before making hardwood molding, always plane stock to within 1/16" of the finished thickness of the molding. If the finished thickness of the molding is to be 1/2" you should start with stock no thicker than 9/16". When making patterns requiring the removal of a large amount of wood, it is best to make re-runs.
12. Be sure all guards are in place before operating equipment.
13. Read operators manual thoroughly and familiarize yourself with machine before attempting to operate.

ILLUSTRATED PARTS BREAKDOWN MULTI-DUTY POWER TOOL MODEL NUMBER 9103

PLANER-MOLDER MODEL NUMBER 9123

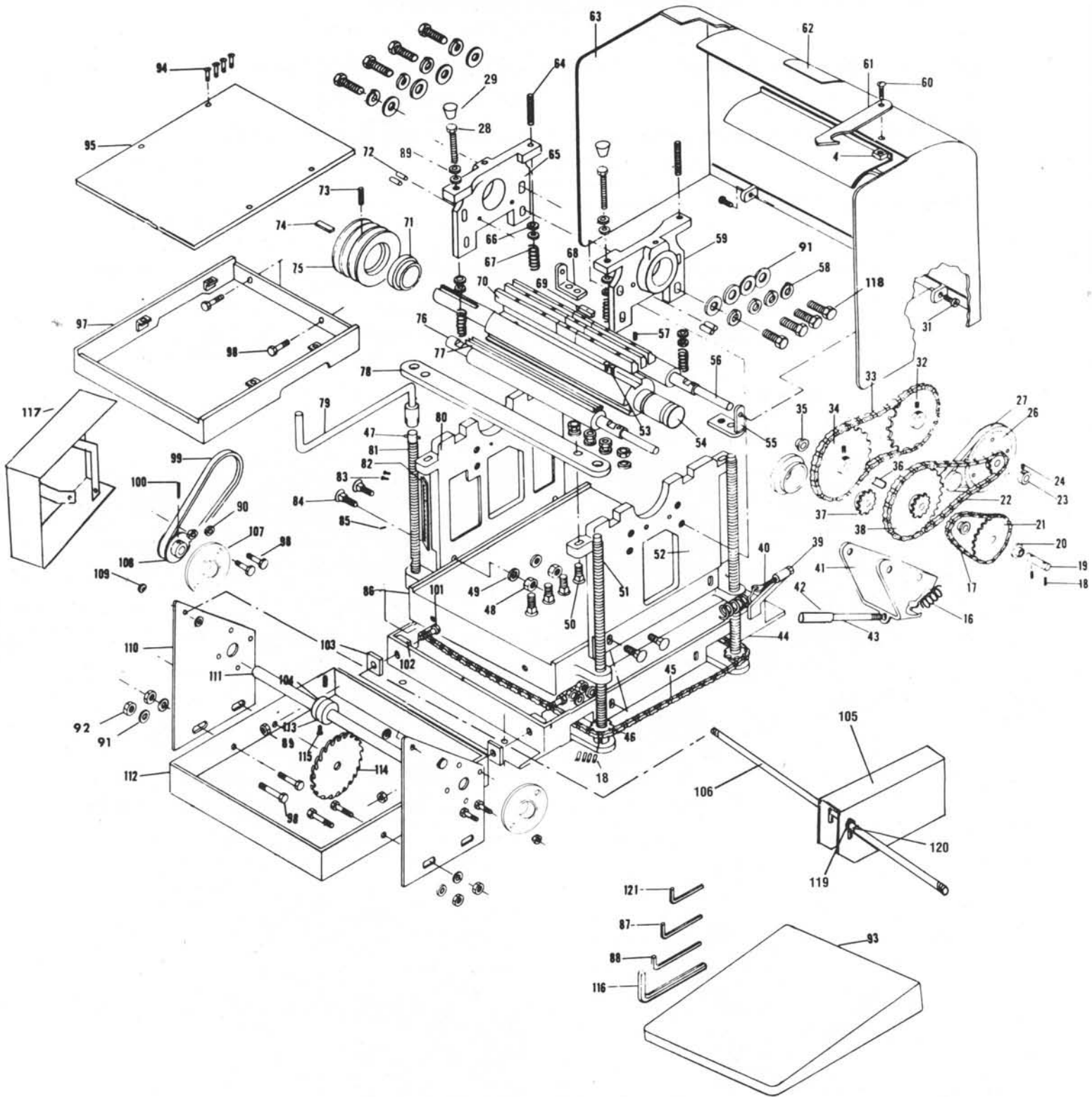

ALL UNNUMBERED
PARTS INTER-CHANGEABLE
WITH OPPOSITE SIDE

PARTS LIST

MULTI-DUTY POWER TOOL MODEL NO. 9103 — PLANER-MODEL NO. 9123 FLOOR STAND MODEL NO. 9181

WHEN ORDERING REPAIR PARTS, ALWAYS GIVE MODEL NUMBER, PART NUMBER AND NAME AS SHOWN IN THIS PARTS LIST.

Do not use Key Numbers when ordering Repair Parts, always use Part Numbers.

PARTS FOR MODEL NO. 9181 FLOOR STAND

KEY NO.	PART NUMBER	DESCRIPTION
1	P-539	Side Piece
2	P-540	Stand Top
3	P-541	Lower Leg Braces
4	P-543	Motor Mount Bar
5	*Z-179	5/16 - 18 x 3/4 Carriage Bolt
6	*Z-36	5/16 - 18 Hex Nut
7	*Z-178	5/16 Split Washer
8	*Z-67	Hex Head Cap Screw - 3/8" - 16 x 1-1/4" long (with Flat Washer and Hex Nut)
10	P-542	Saw Table Braces with Bolts, Nuts, Split Washers.

PARTS FOR MODEL NO. 910/912 PLANER

KEY NO.	PART NUMBER	DESCRIPTION
16	P-374	Tension Spring
17	P-355A	#35 Roller Chain, 17-3/4" (12' Rate) or P-382 #35 Roller Chain (14") (22' Rate)
18	*Z-180	Roll Pin 1 ea. 3/16 x 1-1/8 + 3/16 x 1-1/2
19	P-362	Shaft
20	P-369	Bronze Bearing
21	P-363A	Sprocket (#35-35T) (12' Rate) or P-381 Sprocket (#35-17T) (22' Rate)
22	P-354A	#35 Roller Chain, 26 1/4"
23	P-364	Set Collar
24	*Z-83	Set Screw (1/4 - 20 x 1/4 Socket Head)
26	P-356A	Assembly; V-Pulley and Sprocket (#35-13T) with two P-368 installed
27	*P-365	V-Belt (O-Section - 20")
28	*Z-150	3/8 - 16 x 3 Hex Screw
29	P-321	Rubber Tip
31	*Z-181	5/16 - 18 x 1 HH Cap Screw, washers & nut
32	*Z-82	Set Screw (3/8 - 16 x 3/8" Socket Head)
33	P-353A	#35 Roller Chain (32")
34	P-350	Sprocket (#35-45T)
35	P-368	Bronze Bearing
36	P-367	Bronze Bearing
37	P-366	Sprocket (#35 - 13T)
38	P-351A	Plate Sprocket (#35-45 and 13T) with P-367 installed
39	*Z-81	Nut (5/16 - 18 Hex)
40	P-378	Adjusting Screw
41	P-359	Assembly; Drive Idler with two-each P-368 and P-369 installed
42	P-361	Rubber Flex Grip
43	P-360	Handle
44	P-375	Base
45	S-41	#35 Roller Chain (66")
46	S-4	Sprocket
47	*Z-59	Roll Pin (1/4 x 1-1/8")
48	*Z-69	Nut (1/2 - 13 Hex)
49	*Z-70	Washer (1/2" Plain)
50	*Z-56	Carriage Bolt (3/8 - 16 x 1-3/4)
51	S-5A	Corner Screw
52	P-377A	Right Side Casting
53	Z-182	1/4 - 28 x 3/4 flat head socket set screw
54	P-370A	Cutterhead
55	P-373	Hood Support, Right
56	P-352	Feed Roll
57	*Z-87	Set Screw (3/8 - 24 x 5/8 Socket Head)
58	*Z-71	Washer (3/8" Lock)
59	H103-A	Brg Hsg Right

KEY NO.	PART NUMBER	DESCRIPTION
60	*Z-183	1/4 - 20 x 3/4 RH slotted mach. screw
61	P-371	Hook
62	*Z-52	Name Plate and Drive Screws
63	P-385A	Hook and Chipbreaker
64	*Z-184	3/8 - 16 x 2 Socket Head Set Screw
65	H-104A	Bearing Housing, Left
66	*Z-73	Nut (3/8 - 16 Hex, Jam)
67	S-19	Feed Roll Tension Spring
68	P-379	Hood Support, Left
69	P-389	Gib (1") and Spacer
70	P-388	Gib (5-3/4")
71	M-2	Ball Bearing (1-1/2")
72	*Z-24	Roll Pin 1/4 x 1-1/8
73	*Z-185	5/16 - 18 x 5/16 Socket Head Set Screw
74	*Z-89	Key (3/8" Square)
75	P-384	V-Pulley, "A" 3.8" - 3 Groove for Model 9103 Planer-Molder-Saw
76	S-57	Feed Roll Bearing
77	958	Planer Knives
78	H-108	Top Front Bar
79	U-269	Crank
80	P-376A	Left Side Casting
81	S-34A	Corner Crank Screw
82	S-279	Scale
83	*Z-92	Drive Pins
84	*Z-68	Carriage Bolt (1/2 - 13 x 1-1/2)
85	Q-7	Pointer
86	E-101B	Bed
87	Z-131	5/32 Set Screw Wrench
88	Z-129	3/16 Set Screw Wrench
89	Z-186	3/8 - 16 Hex Jam Nut
90	*Z-51	Hex Nut (3/8 - 16)
91	*Z-50	3/8 Flat Washer
92	*Z-58	Nut (3/8 - 16 Hex)
93	2S5	Extension Table for Model 912

PARTS FOR MODEL NO. 9103 MULTI-DUTY POWER TOOL

KEY NO.	PART NUMBER	DESCRIPTION
94	*Z-187	12 - 24 x 3/4 Flat Head Slotted Mach. Screw
95	P-312	Table Top
97	P-300	Table
98	*Z-63	3/8 - 16 x 1 Hex Hd. Cap Screw
99	P-318	V-Belt A47
100	*Z-188	Roll Pin (3/16 x 1-3/4)
101	*Z-189	3/8 - 16 x 1-1/2 HH Cap Screw
102	P-317	Spacer
103	P-316	Spacer, Threaded
104	P-313	Spanner Nut
105	P-322	Guard
106	P-303	Holddown Bar
107	P-306	Flange Ball Bearing (1")
108	P-308	V-Pulley, "A" 4"
109	*Z-190	1/2 - 13 Hex Jam Nut
110	P-302	Side Panel
111	P-305	Arbor
112	P-301	Base
113	P-315	Arbor Collar
114	P-314	Saw Blade, 10" Diam.
115	*Z-60	Cap Screw (3/8 - 24 x 1 Socket Head)
116	Z-54	5/16 Set Screw Wrench
117	P-320	Belt Guard
118	*Z-67	Cap Screw (3/8 - 16 x 1-1/4" Hex Head)
119	*Z-70	1/2" Flat Washer
120	P-364	1/2" Collar with Set Screw
121	*Z-128	1/8 Set Screw Wrench

ASSEMBLY INSTRUCTIONS FOR NEW MODEL 9181 PLANER STAND

- 1 — Use #5 Carriage Bolts to attach No. 1 side pieces to No. 2 Stand Top.
- 2 — Attach No. 3 Lower Leg Braces with #5 Carriage Bolts. After leveling stand, tighten all nuts and bolts.
- 3 — Attach No. 4 Motor Mount Bars to slotted holes in No. 3 Lower Leg Braces using No. 5 Carriage Bolts.
Leave loose until motor has been properly positioned.

NOTE: Assemble first with all nuts only finger tight. After final assembly and with base on level floor, use wrench for final tightening.

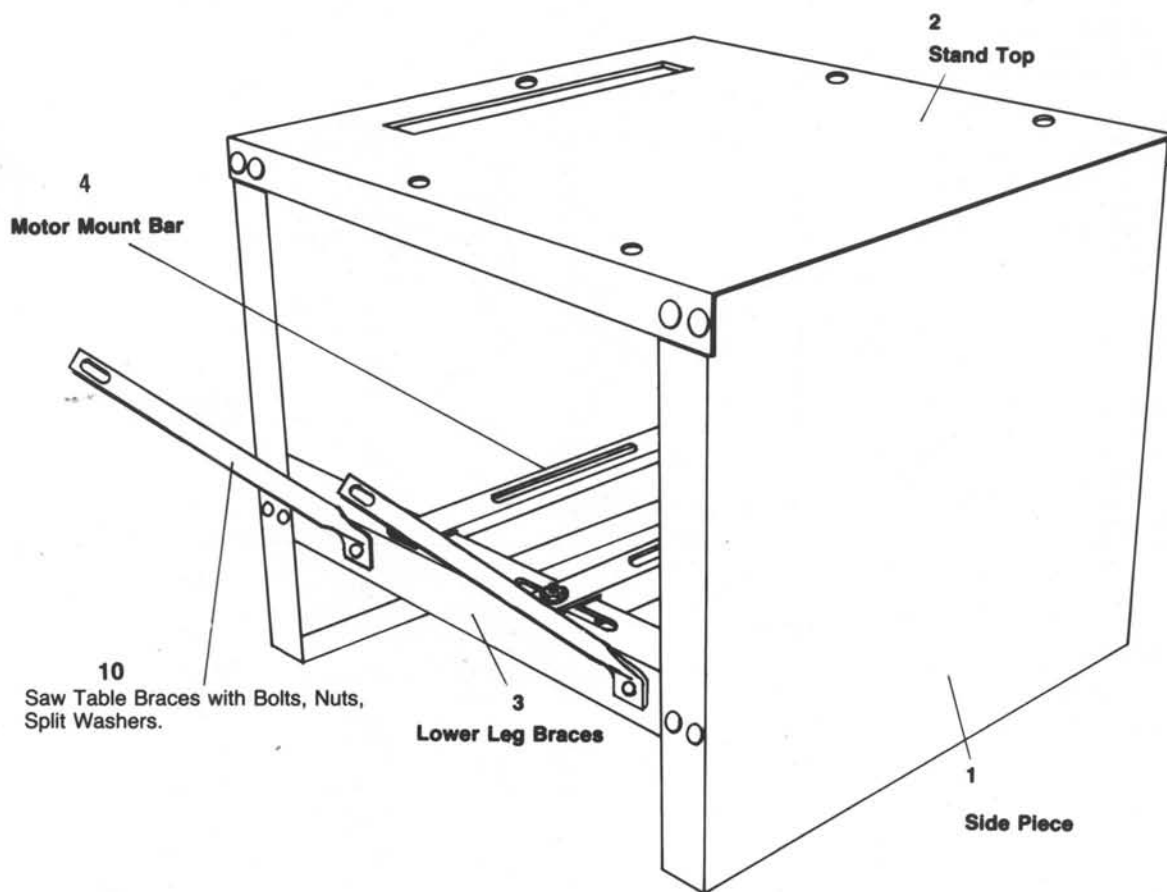

Figure 1



- 8 Hex Head Cap Screw - 3/8" - 16 x 1-1/4" long (with Flat Washer and Hex Nut)**

- 7 Split Washer**



- 6 5/16 - 18 Hex Nut**

- 5 5/16 - 18 x 3/4 Carriage Bolt**

TO ORDER REPAIR PARTS

Your Belsaw PLANER is warranted for one full year against defective material or workmanship. Should any part need replacement during this period for reasons other than normal wear or abuse, please write us for shipping instructions. **Our Kansas City office is not equipped to handle returns.** We will advise you immediately the correct factory address to which the item is to be shipped. This will avoid delay in making the required adjustment.

Due to inflation and rising costs, parts prices are subject to change without notice. Therefore, should any part require replacement for other reasons or after the warranty period, please fill out the enclosed postage paid Price Request Card and mail it to us. We will then furnish you with current prices.



BELSAW MACHINERY CO

315 WESTPORT ROAD, BOX 593 • KANSAS CITY, MO. 64141

Phone: 816-561-9255

ASSEMBLY-OPERATING INSTRUCTIONS

MOUNTING ON MODEL 918 FLOOR STAND

1. Use four of the Number 8 cap screws, washer and nut in top of stand as studs. Center Number 44 Base on these studs. Bolt machine to base with nuts and washers provided in parts bag.

MOUNTING ON WOOD BASE

Bolt Number 44 Base to substantial support stand approximately 20" high by 18" wide and 24" long. Position cross-members for 3/8" bolts or lag screws to be used in the four base bolt holes on 9-3/4" centers across by 20-5/16" long.

MOTOR RECOMMENDATIONS

For moderate duty with standard rate of feed we recommend a 3-HP electric motor. For heavier use and faster feed rate, we suggest a 5 horsepower electric motor.

Your Planer is equipped with a 3.8" diameter cutterhead pulley. To give the cutterhead its recommended speed of approximately 4,000 rpm, you should use a 9" motor pulley with a 1750 rpm motor, and a 5" motor pulley with a 3450 rpm motor.

A single standard A-section V-belt will transmit up to 2-1/2 HP at these speeds. A "special duty" A-section belt, such as Gates Super Rope, transmits up to 3-3/4 HP. To transmit full 5 HP, use two V-belts from motor.

Mount the motor under the Planer, with the motor pulley in line with the cutterhead pulley. Wire so the motor will turn counter-clockwise.

ASSEMBLY

1. Screw Number 43 Handle into Number 41 Casting.
2. Connect Number 93 Outfeed Extension Table to Number 86 Planer Bed with two of the 3/8" x 1" bolts and washers (from parts bag).
3. Run Number 101 cap screw through Number 102 Spacer and Number 44 Base from inside. Tighten Number 103 threaded Spacer as a Nut outside Number 44 Base. Bolt Number 112 Base securely, using Number 13 screw and hex nut furnished. If you are using stand you supply, place wood blocks approximately 2" x 4" x 4" long inside the infeed corners of Number 112 Base and screw to stand. These blocks stabilize the saw assembly.
4. If using Number 9181 Stand, attach the Number 10 Braces to Stand with 5 Carriage Bolts. Attach Braces to Number 112 Base using Number 98 Bolt, Number 91 Washer and Number 92 Nut.
5. Connect the Number 97 Saw Table to Number 86 Planer Bed with the remaining two 3/8" x 1" Bolts and Washers.

ATTACHING SAW BLADE

1. Loosen Number 94 Screws, remove Number 95 Table Top and lay it on Number 86 Planer Bed.
2. Loosen Set Screws in Number 107 flanged Ball-Bearing Collars.
3. Loosen the two Number 115 Cap Screws in Number 113 Arbor Collar and unscrew Number 104 Spanner Nut.
4. Move Number 111 Arbor to clear right bearing.
5. Remove Number 113 Arbor Collar and attach Saw Blade with teeth pointing to Planer cutterhead. Reassemble Nut and Collar on Arbor with Saw Teeth pointed to cutterhead – be sure Number 104 Spanner Nut is on *pulley* side of blade.
6. Slide Number 111 Arbor back into right Bearing and line up Number 108 V-Pulley with outside groove of Number 75 V-Pulley on cutterhead. Tighten set screws in the Number 107 Bearing Collars.
7. Attach Number 99 V-Belt from Number 108 V-Pulley to outside groove of Number 75 V-Pulley.

8. Remove #90 nuts from #98 bolts that hold left saw arbor bearing housing in place. Attach #117 belt guard and replace #90 nuts. This guard is a safety requirement and must be in place as shown in Figure A when saw is in use.

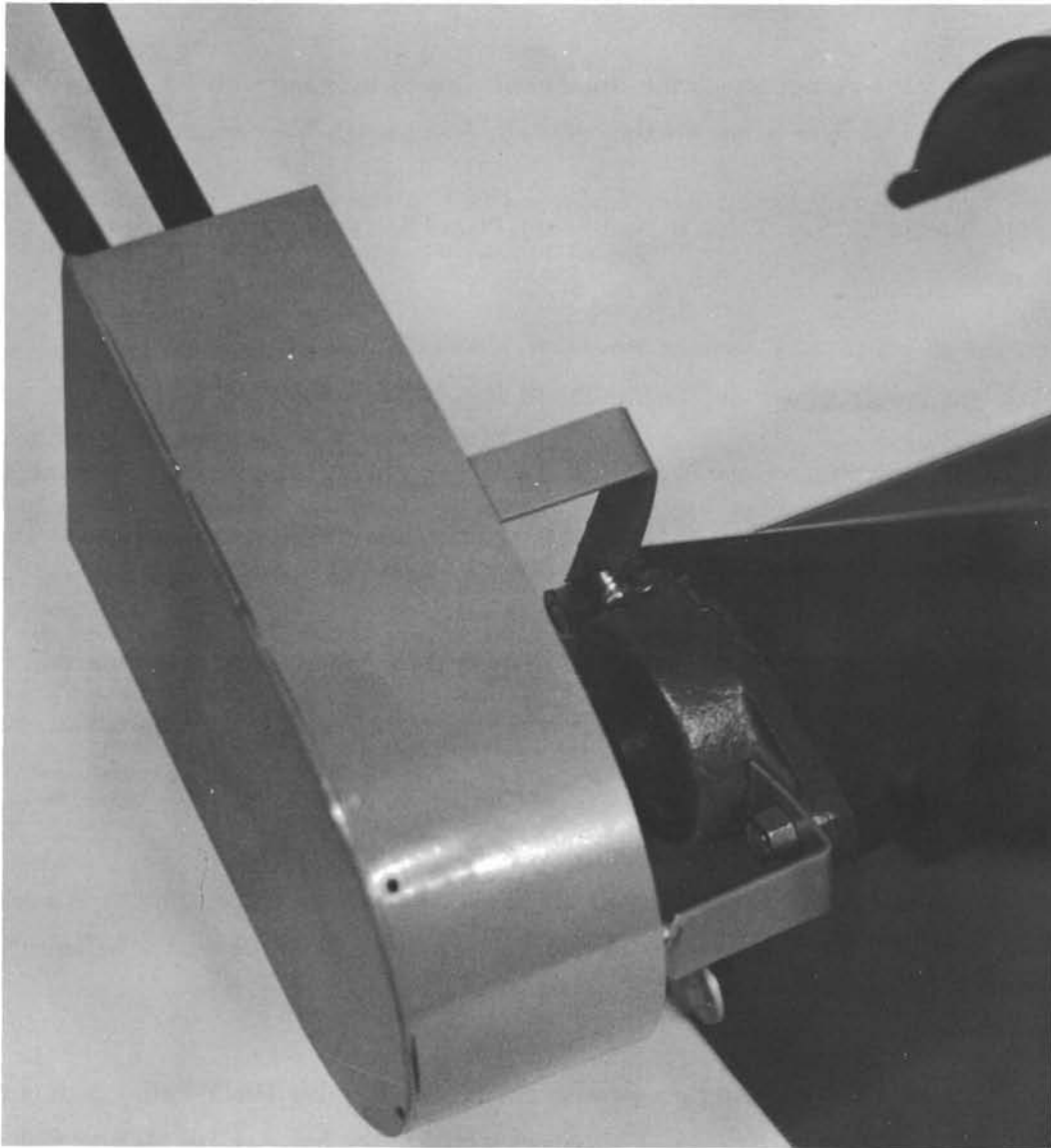

Figure A

SLOTING SAW TABLE

The table top can be slotted to clear saw at any desired position. This slotting can be done very quickly by the method illustrated in Figure B. To cut three of the most used slots:

1. Loosen one Number 57 center cutterhead Set Screw with the 3/16" Socket Wrench and remove the Number 69 Center Gib and Spacer.
2. Select a cutter bit with straight sides, such as #302, #303, or #354. Bottom the cutter bit in cutterhead, tighten Number 57 Set Screw until Gib holds Knife firmly.
3. Fix Number 95 Table tight against Pulley side of Planer Bed and turn cutterhead by hand until the cutter bit marks the plywood enough to give points along which to draw the slot lines.

At this point, either remove the Cutter Bit and replace Number 69 Center Gib and Spacer or install the two matching Cutter Bits, depending on your operating plans.



Figure B

ALTERNATE STEPS FOR SLOTING SAW TABLE

1. Fix Number 95 Table Top tight against pulley side of Planer Bed.
2. Hold square on center end of the Number 70 long Gib at pulley side and mark point on Table. Move table so as to get second such mark from square end of the Gib. With the two points, draw line full length of the table.

3. Draw a second parallel line 1" toward center of Table Top.
4. After Step 3, proceed to slot table by removing Number 106 Hold Down Bar by loosening Number 109 End Cap Screws.
5. Turn Number 79 Crank counter-clockwise to bring Number 97 Table to its lowest position.
6. With table flat on Number 86 Planer Bed, loosen Number 115 Cap Screws in Number 113 Arbor Collar and move saw on arbor to line up with first marked slot-line. Tighten Number 115 Cap Screws.
7. With Table butted against Number 86 Planer Bed, lower Hood, turn on Motor and bring Table down on the running blade to cut slot, as shown in Figure 2.
8. Turn OFF motor, move saw on arbor to second marked line and cut second slot.
9. Turn OFF motor, move saw to farthest position left (on pulley side) and cut third slot in plywood table. This is for "storage" and might be preferred on right (feed side) by some operators.
10. With motor OFF, attach Number 95 Table Top to Number 97 Table with Number 94 Screws, leveling the Table Top with surface of Number 86 Planer Bed.

ALIGNING SAW ARBOR

1. Place Stock Guide flush along milled shoulder on Planer Bed.
2. Loosen the four Number 98 Cap Screws in Number 110 Side Panels and slide panels to tighten Number 99 V-Belt.
3. Line saw blade parallel to Stock Guide and tighten the Number 98 Bolts to secure side panels.
4. Replace Number 106 Hold-Down by tightening Number 109 Cap Screws and slide Number 105 Saw Guard to cover the blade.

CAPACITY

1. Maximum depth saw cut is 2-1/4". Saw can be placed at any point up to 11-1/4" on stock up to 12-1/4" wide.
2. Maximum depth of planing cut is 3/16". Minimum stock thickness is 3/16" and minimum stock length is 7".

Planing capacity without Rip Saw Attachment is 12-1/4" width and 6" thickness.

Planing capacity with saw is 11-1/4" width and 2-1/4" thickness.

CONTROLS

1. Hood acts as a complete machine guard and should always be down when motor is on. As stock is fed under the hood it will contact the chipbreaker and raise the hood 1/16 inch. This allows chipbreaker to ride on stock as it is fed through the machine. This prevents wood shavings from being thrown toward the infeed or operating side of the machine.
2. Number 79 Crank is used to set height of Planer Bed and Saw Table. Each full turn of crank moves the Bed 1/16". Do not take more than 3/16" (three full turns of crank) cut in single pass – for deeper cuts, make re-runs, taking equal amounts of each side.
3. Scale Pointer indicates distance between Planer Knives and Bed. It can be quickly adjusted to accurate reading by simply bending pointer.
4. Depth of molding cuts is determined by distance Bed is moved. Do not raise Bed high enough to permit contact with Cutter Bits.

5. A "featherboard", as shown in Figure C, can be of great help in guiding stock for both saw and molding cuts. It is quickly made from any piece of 1" thick stock approximately 8" long and 3" wide. Saw the parallel slots about 4" deep and 1/8" apart. The "featherboard" can be C-clamped onto saw or extension tables to exert holdover spring tension.
6. Select a straight piece of hardwood for a stock guide. This piece should be 2" x 1/2" x 46" long. The guide should be exactly parallel to the milled side of the Planer Bed. It can be held with C-clamps and positioned at any place across the bed.



Figure C

LUBRICATION

The heart of any machine is the bearings used to support its moving or rotating parts. There are many kinds of bearings used on modern machinery and the maintenance and lubrication of such bearings are the utmost importance.

Use a good grade of #10 weight oil on:

1. Threads and bearing points of the #51 and #81 Corner Screws. There are also oil reservoirs located on the ears of the #86 bed for each corner screw. Use one to two drops of oil in these reservoirs every 30 days. There is no need to clean sawdust or wood shavings from these reservoirs; once this has accumulated in the reservoir, it will aid in the even feeding of oil to the threads of the corner screws and bed casting.
2. Oil reservoirs of the #76 Oil Impregnated Bronze Bearings on the feed rolls. These bearings are actually powdered bronze that has been pressed together under tremendous force. This compressing action leaves small spaces or pores between the grains of the metal. The compressed bearings are then soaked in an oil bath which saturates and impregnates the metal. In medium, or slow speed applications, the oil is gradually used up out of the pores of these bearings, as required. Depressions, called "dimples" are drilled into these bearings, taking care not to penetrate the bearing wall completely. These dimples are used to retain a small quantity of oil. In most cases replenishing the oil supply every 3 months is sufficient.
3. Sprocket oil holes—place 1 to 2 drops of oil in these holes every 14-21 days of operation.
4. The recommended lubrication for roller chains used in medium to slow speed operation is to simply wipe the chain clean. When there is an appreciable buildup of dust, dirt or wood shavings, use an oil cloth and never pour the oil directly on the chain. Over-oiling defeats the purpose of the lubrication, since it simply tends to hasten the collection of dust, shavings, etc. and works into members of the chain. This hastens wear and leads to premature replacement.
5. Close fitting parts, such as gibs and the planer cutterhead sockets should also be wiped with an oily cloth and freed from clinging foreign matter and then replaced in respective position, slightly dampened with oil. *Do not soak these parts with oil.*
6. Occasional use of paste wax or paraffin on the #86 Bed, #93 and #95 Table Surfaces will prevent rust and reduce friction to ease feeding.
7. Remove resin and other accumulations from feed rolls and bed with kerosene.

The #71 Bearings on the #54 Cutter head and the #107 Bearings on the #111 Saw Arbor are factory lubricated and sealed. They require no further attention.

PLANING & SAW INSTRUCTIONS

FUNDAMENTALS OF PLANING

The art of thickness planing consists mainly of using good judgment about the thickness of the cut in various types and quality of work pieces, not only the width and hardness of the board, but also its dampness, straightness, grain and grain structure are important. The effect of these factors upon the quality of finished work can only be learned through experience. It's advisable whenever working with a new type of board, or one with unusual problems, to make a test cut on a scrap if possible.

A planer's function is to finish stock to uniform thickness. Stock that is warped, or twisted cannot be straightened on a thickness planer. One surface must first be flattened on a jointer.

When possible, always feed boards in the direction that has the Planer Knives cutting WITH the grain. Place the best, or flattest, side DOWN.

Do not feed pieces shorter than 7". Butt stock whenever practical, especially short pieces.

Support long boards at both infeed and outfeed ends so as to KEEP IT LEVEL throughout entire travel.

If regularly surfacing long stock, provide outboard rolls or tables with provision for adjusting height.

When forced to plane a board that is bent or bowed so that ends are higher than its middle section, always start with the end curving UP, not down.

Because of their many advantages, we have been experimenting with rubber feed rolls for several years. Now a leading rubber company has worked out a rubber formula that guarantees a long life of trouble free performance.

The interior of a board is usually more moist than the surface. If all stock is removed from one side, you will end up with one dry and one moist side, a condition that will result in warpage as the moist side dries out.

When planing wet or resinous stock, keep feed rolls clean by wiping with rag moist with kerosene.

Woodworking machine operators know the importance of keeping their machines properly oiled and greased. Some make a regular practice of rubbing a candle or paste wax on the infeed table of machines, such as planer and jointer.

As the work distributes the wax it closes "surface pores". This practice not only reduces friction, but also gives some protection against rust.

While conventional solid roll planers cannot efficiently handle stock of varying thicknesses at the same time, this speedier method is practical with this design where rubber rolls are combined with solid bed. Do not abuse this feature but you can safely combine thicknesses which do not vary over 1/8".

PLANING

1. Measure thickest part of board to be planed and determine finish thickness you desire.
2. With board on Planer Bed, turn Number 79 Crank until Scale Pointer reads the desired finish thickness.
3. If difference between original and finish thickness exceeds $3/16''$, lower Bed as necessary to stay within the $3/16''$ limitation. (Use re-runs to get final thickness).
4. Start board under Number 56 Infeed Roll so that it travels in a straight line. When Feed Roll takes hold, you let go, and stand to one side – *NOT* in direct line with board. The Power Feed completes the travel without further pushing or pulling.
5. It is wise to check accuracy of the Scale after making initial planing cut. See scale in Figure D. See how board measures against reading of the Scale Pointer. If any error, correct by bending the Pointer.

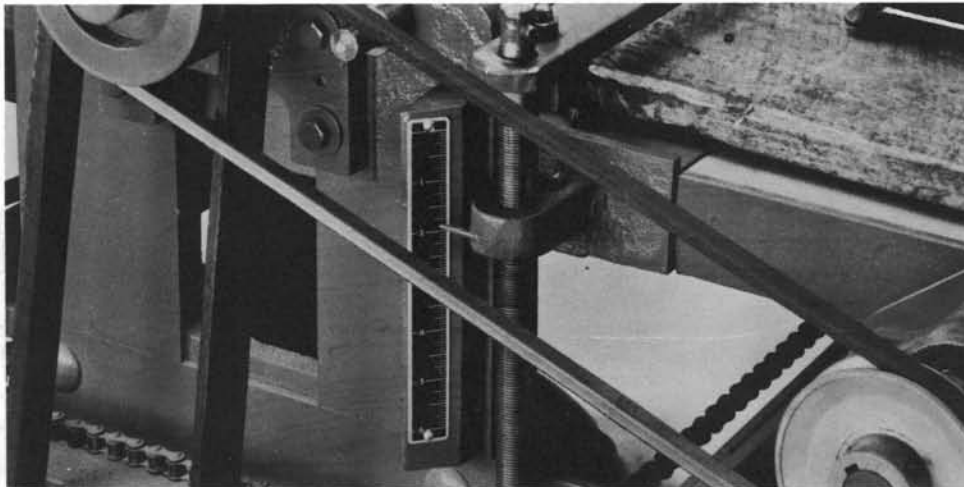

Figure D

SAWING

1. Always determine if existing saw slots are in position to give desired cut. If not, remove Table Top and cut any new slot required.
2. Place Stock Guide in desired position and secure with C-Clamp.
3. C-Clamp featherboard to press on opposite edge of stock.
4. Adjust Number 106 Hold-Down and Number 105 Saw Guard as required.
5. Use Number 79 Crank to bring Bed to height that will give board proper contact with feed rolls.
6. Push board past Saw until it reaches Number 56 Feed-Roll which will power feed it through.
7. When saw is not being used during planing or molding operations, either remove Number 112 Base or move Blade and Number 105 Guard out of way to slot at side of the table. Also, disconnect the Number 99 V-Belt when Saw is not in use.
8. Saw has anti-kick back rotation – a highly desirable safety feature practical only in this design's combination of stock hold-down and powered feed rolls.

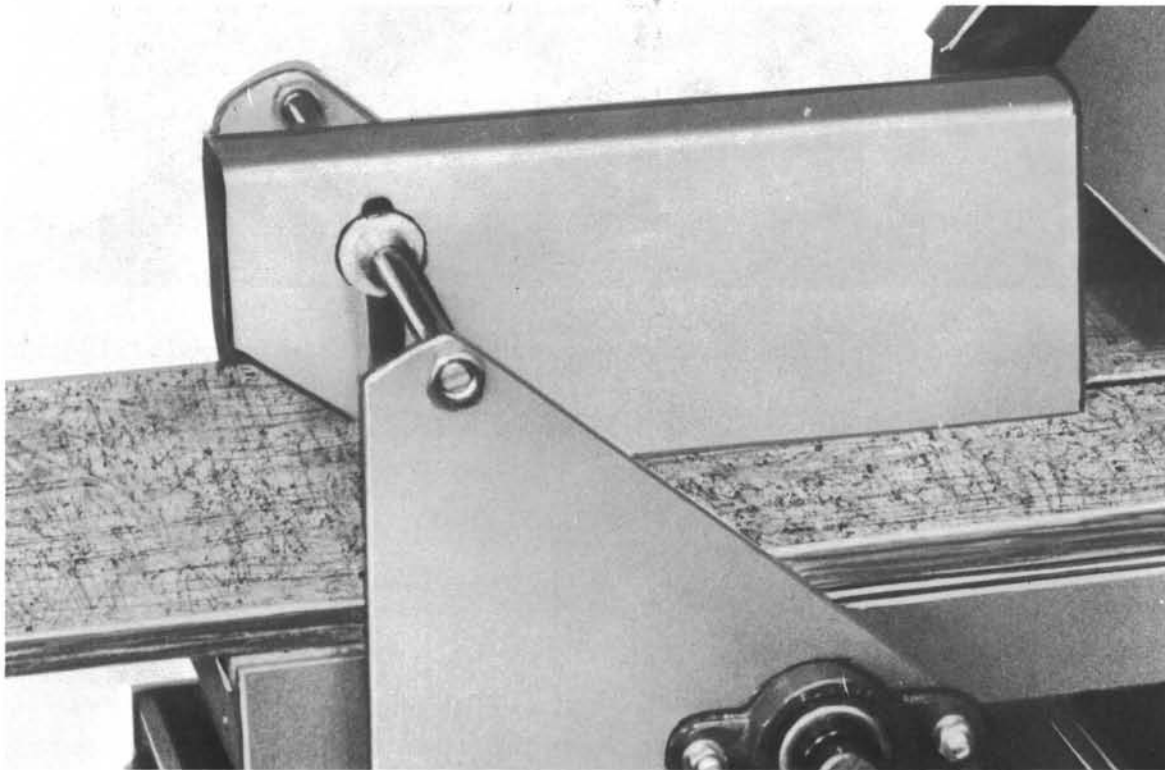

Figure E

ADJUSTMENTS:

1. Infeed roll pressure is determined by spring tension. Increase spring tension by turning No. 28 Screw clockwise. Reduce tension by turning screw counter-clockwise.

Use wrench to loosen No. 28 Lock Nuts. This allows adjustment of No. 28 Hex Bolts. Hold No. 28 Hex Bolts in position and tighten Lock Nuts to secure.

Infeed Roll needs MORE tension when board does not start under cutterhead smoothly and positively. It needs LESS tension if the Roll must be forced up to accept the board.

Outfeed Roll should exert enough pressure to pull the board on through cutterhead after it leaves Infeed Roll. Reduce tension if board halts or bumps when first contacts Outfeed Roll. Increase spring tension if board stops or does not continue smoothly after starting under Outfeed Roll.

To increase Outfeed Roll pressure, turn No. 64 Screws clockwise. Reduce tension by turning counter-clockwise. Use Socket Wrench to turn No. 64 Screws. The Lock Nuts are for initial adjustment only and will turn with screws when tight.

Keep spring tension even at each end of rolls so boards will travel straight instead of drifting to one side.

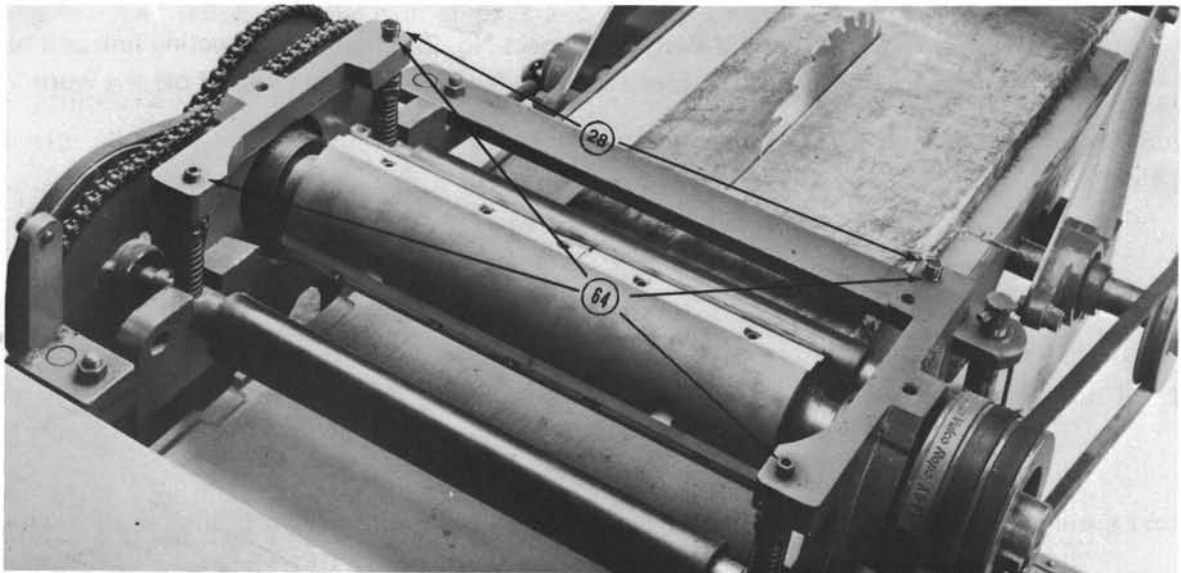

Figure 13

2. Planer Knives are removed for sharpening by loosening the 15 No. 57 Set Screws with 3/16" Socket Wrench. Knives are held in place by wedging action. Screws press against bottom of cutterhead slot forcing gib into wedge. Use a piece of soft metal as a punch, and tap the gibs down into the cutterhead. Planer or pattern knife will then be loose. Remove knife first then gib can be removed. Mark gibs and matching slot to be sure they are replaced in original position.
3. When resetting knives in cutterhead, use the No. 53 Jack Screws to give all three knives uniform correct projection of 5/32".

ADJUSTMENTS (continued)

- (a) Tighten No. 70 long Gibs just enough to hold them in place, bottomed in cutterhead slot.
 - (b) Place a 2"x2"x4" hardwood block on Bed at each end of cutterhead. Make sure the blocks are of identical Thickness.
 - (c) Turn the two No. 53 Jack Screws with the 1/4" Socket Wrench to give *ONE* knife 5/32" projection from the cutterhead.
 - (d) Raise Bed until this first projecting knife just touches the two hardwood blocks. Use the Jack Screws to make the knife scrape each block the same.
 - (e) Tighten the 5 No. 57 Set Screws and recheck to make sure the knife still touches the blocks evenly.
 - (f) Repeat steps 2 and 3 for each remaining knife.
4. If the No. 43 Safety Handle chatters or bounces, it is a sign that the drive requires more spring tension. Increase tension of No. 16 Spring by tightening No. 39 Nut.
 5. Take-up for the No. 27 Feed V-Belt is provided by the four Screws in face of the No. 26 V-Pulley. Tighten these screws to take up the belt.
 6. To replace No. 27 Feed V-Belt, disconnect No. 22 Chain at connecting link and remove from sprocket. Loosen the four screws in No. 26 V-Pulley and roll off the worn V-Belt.
Roll on new Belt, tighten Screws and replace No. 22 Chain.

INSTALLING PLANER BLADES USING THE #953 KNIFE SETTING GAUGE

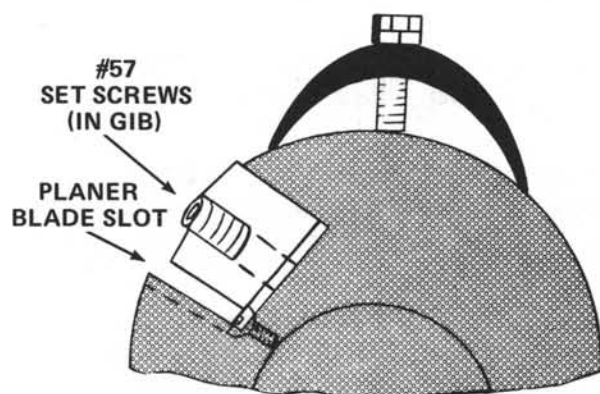

Figure G

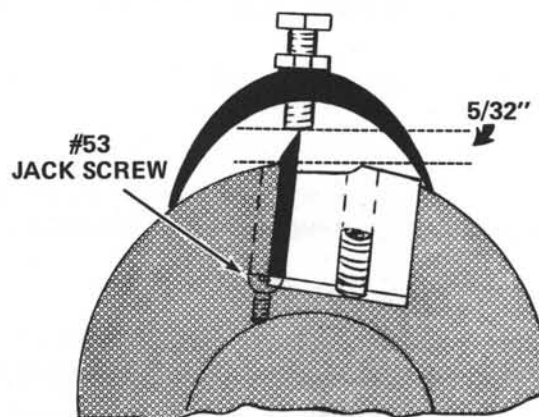

Figure H

Planer blades are removed as explained in steps 2 and 3 on preceding page.

To obtain a projection of 5/32-inch with the Belsaw Model 953 Knife Setting Gauge, place the gauge on the cutterhead with all three prongs firmly resting against the cutterhead. Turn the screw clockwise until it touches the cutterhead (see Figure G,) turn the screw counterclockwise 4 full turns (which allows for a projection of 5/32-inch). Tighten the Lock Nut to maintain this setting.

Position the Knife Setting Gauge over the planer blades (see Figure H). Adjust the #53 Jack Screws to raise the planer blades until the cutting edge of the blades come in contact with the Knife Setting Gauge. Tighten the gibs and check occasionally with the gauge to make sure the original projection has been maintained throughout the length of the blade.

4. If Number 43 Handle chatters or bounces, it is a sign that the drive requires more spring tension. Increase tension of Number 16 Spring by tightening Number 39 Nut.
5. Take-up Number 27 Feed V-Belt is provided by the four Number 25 Screws in face of Number 26 V-Pulley. Tighten these screws to take-up the belt. For additional take-up, the pulley should be separated by removing the four screws. Remove one spacer from each screw and replace pulley. This will tighten belt by causing it to ride higher on Number 26 V-Pulley.
6. To replace Number 27 Feed V-Belt, disconnect Number 22 Chain at connecting link and remove from sprocket. Loosen the four Number 25 screws in Number 26 V-Pulley and roll off the worn V-belt.

Roll on new Belt, tighten Screws and replace Number 22 Chain.

FEED-SPEED CHANGE

Your Belsaw is shipped with P-363A Sprocket and P-355A Chain. This gives feed speed of 12-ft. per minute. Optional faster feed of 22-ft. per minute can be obtained by installing P-381 Sprocket and P-382 Chain.

Be sure you have adequate power. To change over, proceed as follows:

1. Remove connecting Link and Number 17 Chain.
2. Remove Number 18 Drive Pins holding Sprockets on Number 19 Shaft.
3. Exchange Number 21 Sprocket and Number 17 Chain.

MOLDING INSTRUCTIONS

MOLDING KNIVES

Your Belsaw multi-duty power tool lets you plane and saw all in one operation but it also has the added ability to use custom molding knives or cutter bits to let you make moldings as well.







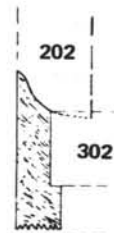

The 1" cutter bits come in three-knife sets that can easily be installed in the cutterhead of the planer while the planer blades are in place.

Custom molding knives are ground from 1/4" high speed, hard steel in a one-knife set. When ordering custom molding knives you'll also be supplied with additional gibs and counterbalance weights to assure that the cutterhead is in perfect balance at all times.

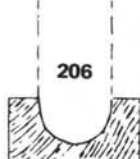
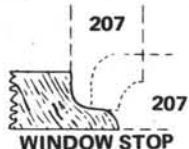
The one-knife method used with Custom Pattern Knives keeps setup time to a minimum and is feasible only because we use finest quality 1/4-inch-thick Super High Speed Steel. Also as a result of the Belsaw one-knife method you will find our charges for pattern knives approximately one-third that of the standard industry price.

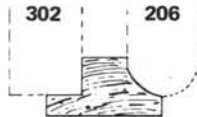
Belsaw has the most complete listing of molding patterns ever offered. All of these popular designs are being used in building trade and are listed by the Western Wood Production Association. Drawings have been reduced slightly — exact dimensions are listed for each pattern. If you wish a custom knife ground to your specifications, send a detailed drawing of the molding or a wood sample for a prompt quotation by return mail.

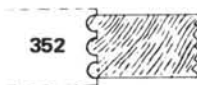
MOLDING CUTTER BITS (ONE-INCH)

 <p>201 GLUE JOINT</p>	 <p>202 302 CASING</p>	 <p>204 DOOR STOP</p>
 <p>206 PICTURE FRAME</p>	 <p>207 207 WINDOW STOP</p>	 <p>208 TABLE EDGE</p>
 <p>302 206 SHELF CLEATS</p>	 <p>303 303 TONGUE AND GROOVE</p>	 <p>351 QUARTER ROUND</p>
 <p>352 TABLE EDGE</p>	 <p>354 SCREEN MOLD</p>	 <p>355 BASE MOLD</p>



Custom pattern knives

You can greatly increase production with your BELSAW Planer-Molder by ordering Multiple Pattern Knives.

EXAMPLE: By ordering Custom Pattern Knife WP-105 4-up, you can produce 4 pieces of 3/4-inch Quarter Round in a single pass.

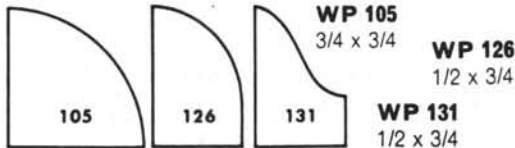

- WP 806** 1/2 x 1-3/8
- WP 836** 1/2 x 1-3/8
- WP 866** 1/2 x 1-3/8
- WP 896** 1/2 x 1-3/8
- WP 926** 1/2 x 1-3/8

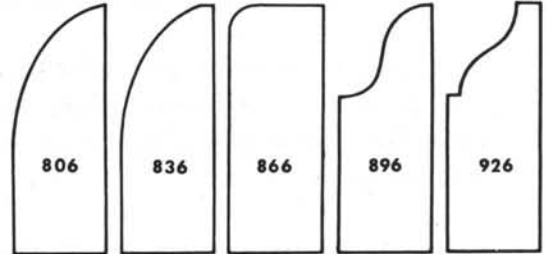

BASE SHOES Shoe mold covers the joint between the base mold and the finish flooring—the final seal against moisture and dirt. Quarter-Round pattern (105) is standard size 3/4" x 3/4". The ogee shape (131) is highly popular.

STOPS On window frames, holds the sash in place. On doors, they stop the door in the closed position. We stock the five basic shapes (shown) in their most popular dimensions.

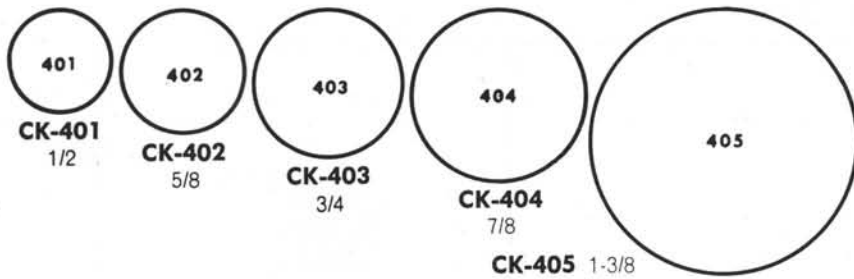

DOWEL Although not truly classified as a molding, these highly useful pattern knives are one of our most popular. Whatever their use, the selection of sizes shown will probably meet your requirements. The same knives are used to produce half-round.

CASING Provides a decorative trim around a doorway, window or other opening. Standard shape for modern trim is the clamshell type (Nos. 301 & 306). Casing is used both inside and out.

- WP 306** 11/16 x 2-1/4
- WP 315** 11/16 x 2-1/2
- WP 316** 11/16 x 2-1/4
- WP 321** 11/16 x 2-1/4
- WP 324** 11/16 x 2-1/4
- WP 326** 11/16 x 2-1/4
- WP 327** 11/16 x 2-1/2
- WP 332** 11/16 x 2-1/4
- WP 341** 5/8 x 2-1/2
- WP 346** 11/16 x 2-1/4
- WP 351** 11/16 x 2-1/2
- WP 356** 11/16 x 2-1/4
- WP 361** 11/16 x 2-1/2
- WP 366** 11/16 x 2-1/4
- WP 371** 11/16 x 2-1/2
- WP 376** 11/16 x 2-1/4
- WP 381** 11/16 x 2-1/2
- WP 386** 11/16 x 2-1/4
- WP 390** 11/16 x 2-5/8

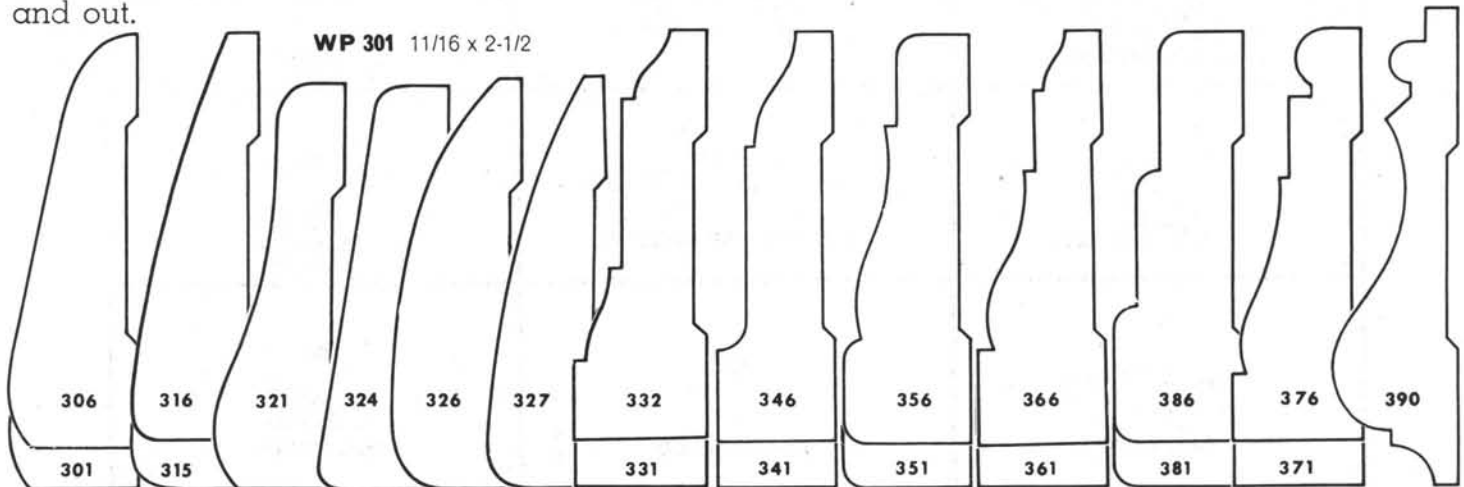

CASING AND BASE

Very similar in shape to standard casing, however these moldings are normally larger. These designs serve either as trim for doors and windows or as baseboard where walls meet floors.

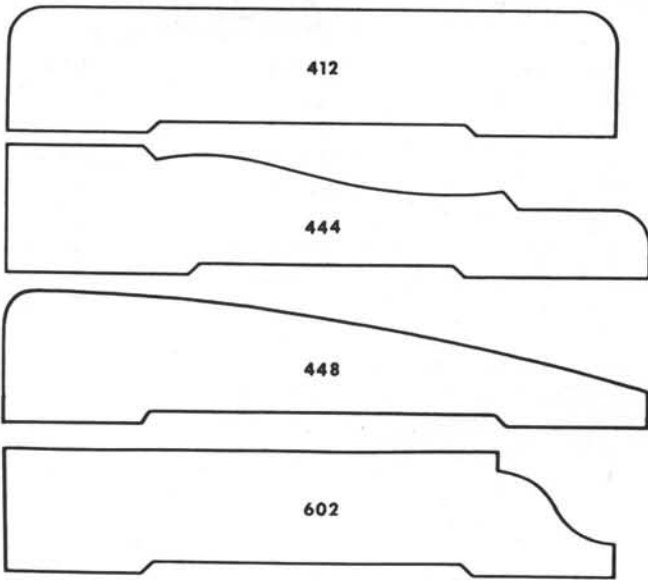

- WP 412** 11/16 x 3-1/2
- WP 444** 11/16 x 3-1/2
- WP 448** 11/16 x 3-1/2
- WP 602** 11/16 x 3-1/2
- WP 642** 11/16 x 3-1/2
- WP 672** 11/16 x 3-1/2
- WP 702** 5/8 x 3-1/2

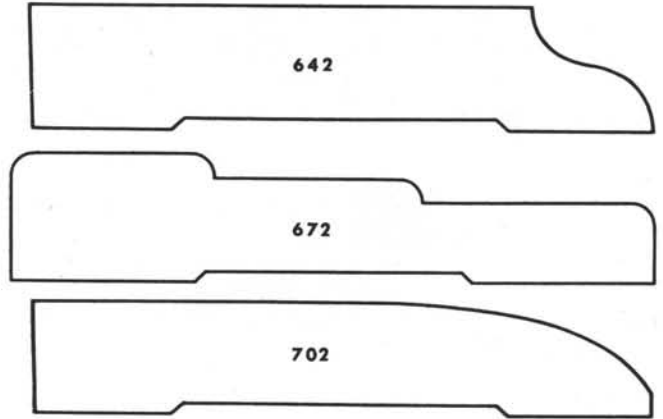

- WP 47** 11/16 x 4-5/8
- WP 48** 11/16 x 4-1/4
- WP 49** 11/16 x 3-5/8
- WP 50** 11/16 x 3-1/2
- WP 51** 11/16 x 3-1/4
- WP 52** 11/16 x 2-3/4
- WP 53** 11/16 x 2-5/8
- WP 54** 11/16 x 2-1/4

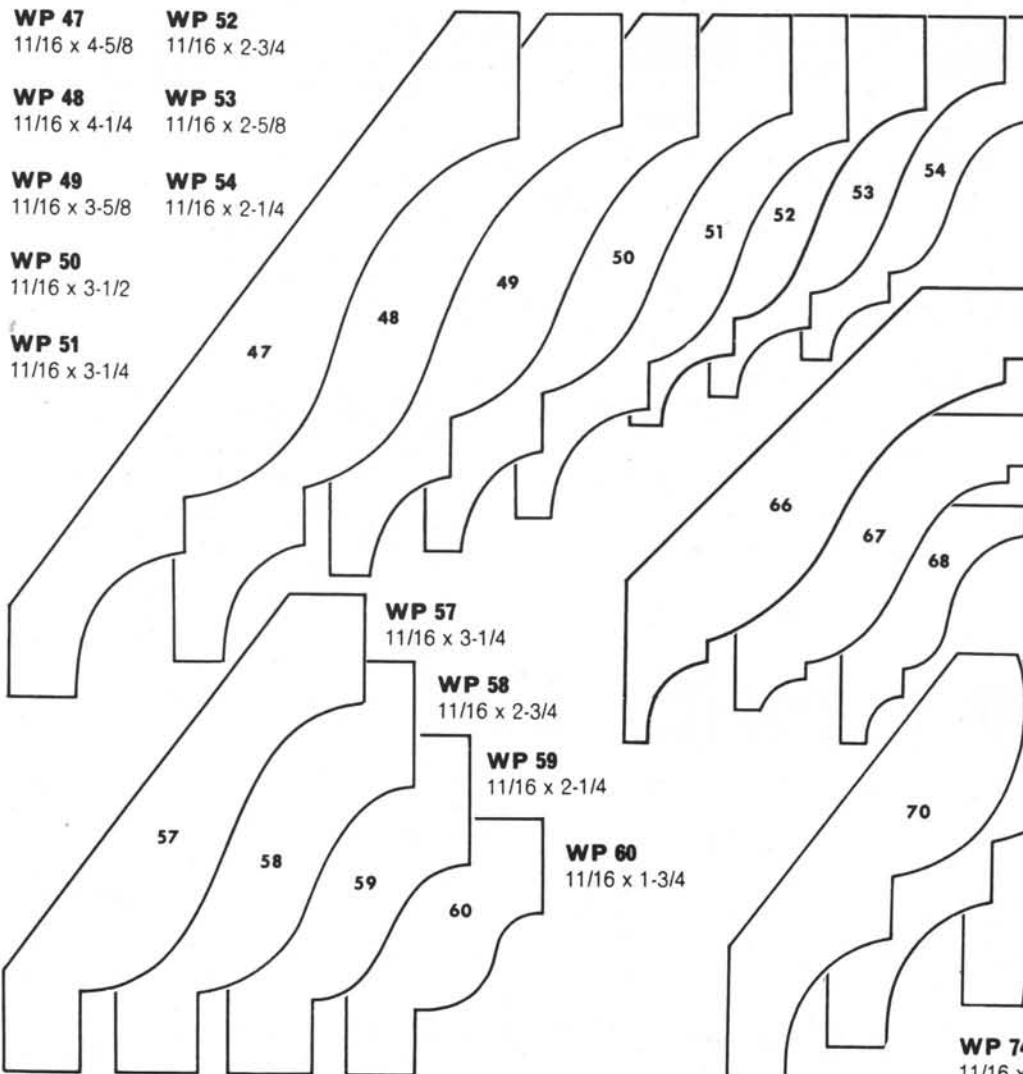

- WP 57** 11/16 x 3-1/4
- WP 58** 11/16 x 2-3/4
- WP 59** 11/16 x 2-1/4
- WP 60** 11/16 x 1-3/4

CROWNS/BEDS

The modern shape of these popular moldings are derived from one classic style dating back to the golden age of Greek architecture. Designed to bridge corner between wall and ceiling since few meet at true right angles. Also popular for use under a fireplace mantle and as frames for mirrors and pictures.

- WP 66** 11/16 x 3-1/4
- WP 67** 11/16 x 2-1/4
- WP 68** 11/16 x 1-5/8
- WP 70** 11/16 x 2-3/4
- WP 71** 11/16 x 2-5/8
- WP 72** 11/16 x 2-1/4
- WP 74** 11/16 x 1-3/4
- WP 75** 11/16 x 1-5/8
- WP 76** 11/16 x 1-1/2

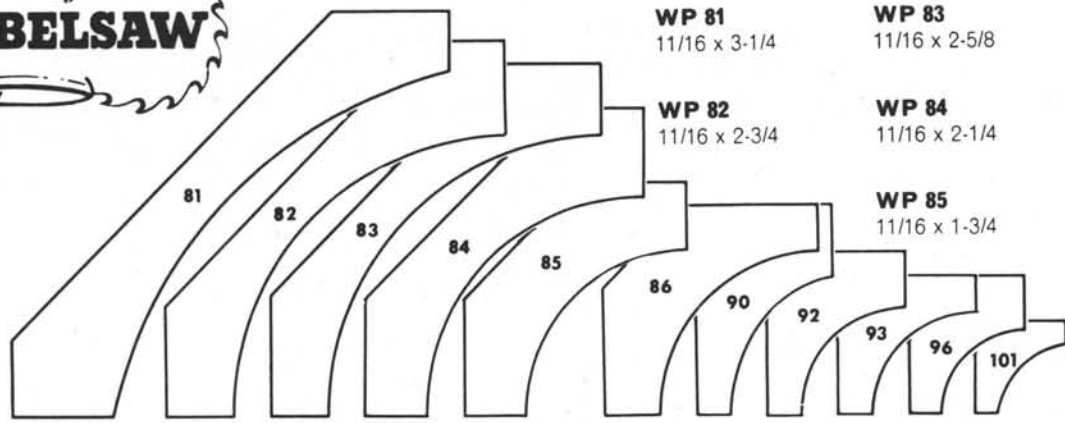

WP 81
11/16 x 3-1/4

WP 83
11/16 x 2-5/8

WP 82
11/16 x 2-3/4

WP 84
11/16 x 2-1/4

WP 85
11/16 x 1-3/4

WP 86
11/16 x 1-5/8

WP 93
3/4 x 3/4

WP 90
3/4 x 1-1/8

WP 96
5/8 x 3/4

WP 92
3/4 x 7/8

WP 101
1/2 x 1/2

COVES Used much the same as Bed and Crown molding, these are designed for use in a corner as a graceful blend between two right-angle surfaces, as at floor or ceiling. Smaller sizes are often used to clean up corners in paneling or to give a finished look beneath the overhang of a desk top. Because of its simplicity, the cove shape adapts well to stark, modern design.



WP 140
1/4 x 3/4

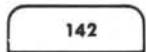

WP 142
1/4 x 3/4



WP 144
1/4 x 3/4

SHELF EDGE/SCREEN MOULD Used as a Shelf Edge, it gives a highly decorative edge to wooden shelves or does a fine job of covering the exposed edges of plywood. Used as Screen Mold, it is used to cover the tacks or staples on window or door screens.

WAINSCOT/PLY CAP A rail-like effect for wainscoting is produced when these highly popular shapes are nailed along the upper edge. Since they cover exposed plies, they are especially effective for edging plywood. Note that the rabbets shown on these moldings accept the highly popular 1/4" veneer paneling.

WP 290
11/16 x 1-3/8

WP 291
9/16 x 1-3/8

WP 292
9/16 x 1-1/8

WP 294
11/16 x 1-1/8

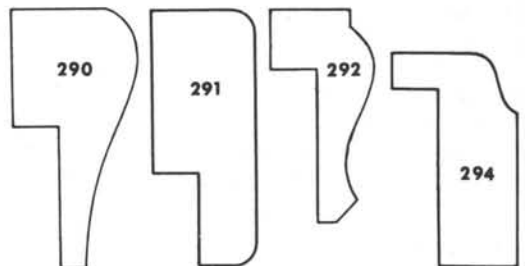

CAP & BRICK (Base Caps)

Special molding for a special job . . . these caps set on the top edge of a standard flat baseboard to give it a finish and to close any gap caused by an uneven wall. Provides a neat trim where brick or stucco meet wood on exterior walls.

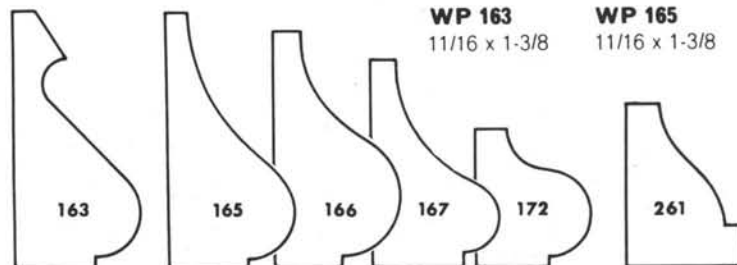

WP 163
11/16 x 1-3/8

WP 165
11/16 x 1-3/8

WP 166
11/16 x 1-1/4

WP 167
11/16 x 1-1/8

WP 172
5/8 x 3/4

WP 261
5/8 x 7/8

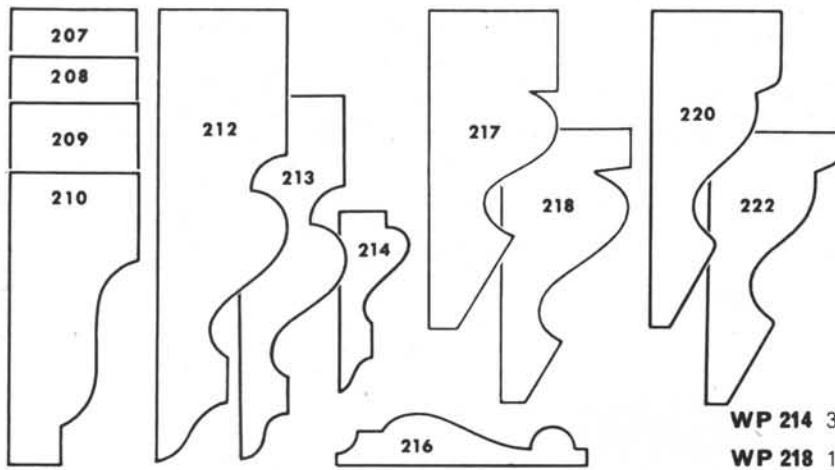

PANEL MOULDINGS Commonly used to top off baseboard and panel wainscoat. Makes an extra good shelf cleat. Mitered and snugged into the corners formed when a flat panel is recessed within a frame, this molding gives the appearance of richly carved paneling. Often used as shingle molding to give a neat, decorative joint where shingles or siding butt against window sills or eaves.

- | | |
|-----------------------------|-----------------------------|
| WP 207 11/16 x 2-1/2 | WP 208 11/16 x 2-1/4 |
| WP 209 11/16 x 2 | WP 210 11/16 x 1-5/8 |
| WP 212 11/16 x 2-1/2 | WP 213 9/16 x 2 |
| WP 214 3/8 x 1 | WP 217 11/16 x 1-3/4 |
| WP 216 9/32 x 1-3/8 | WP 220 11/16 x 1-3/4 |
| WP 218 11/16 x 1-1/2 | WP 222 11/16 x 1-1/2 |

MULLION CASINGS

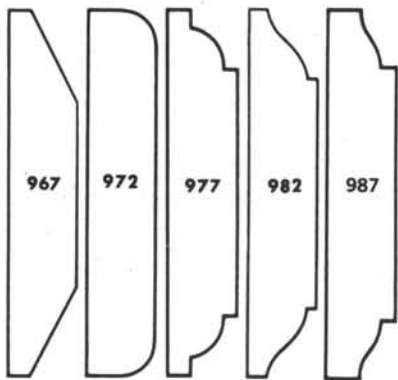

- WP 967** 3/8 x 2
- WP 972** 3/8 x 2
- WP 977** 3/8 x 2
- WP 982** 3/8 x 2
- WP 987** 3/8 x 2

Also called Panel Strips in the new standards, these 3/8" thick moldings are designed to cover vertical

joints between window frames when there is more than one in a series. Their clean, modern lines makes them very popular for use as battens for interior paneling.

MISCELLANEOUS MOLDINGS

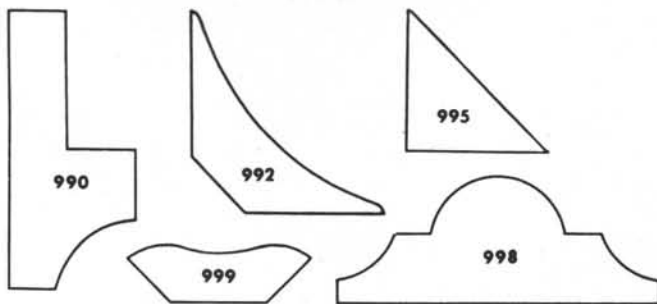

- WP-990** 11/16 x 1-1/2 **SHELF CLEAT**—Nailed to wall or side of case to support shelving.
- WP-992** 9/16 x 1-1/2 **LINOLEUM COVE**—Used as a Base Shoe in rooms with mopable floor surfaces.
- WP-995** 3/4 x 3/4 **CHAMFER STRIP**—Used to finish off inside corners. Gives a bevel effect.
- WP-998** 11/16 x 1-3/4 **ASTRAGAL**—Is attached to one of a pair of swinging doors to act as stop for the other.
- WP-999** 5/16 x 1 **INSIDE CORNER**—Used same as No. 995 except has a more decorative effect.

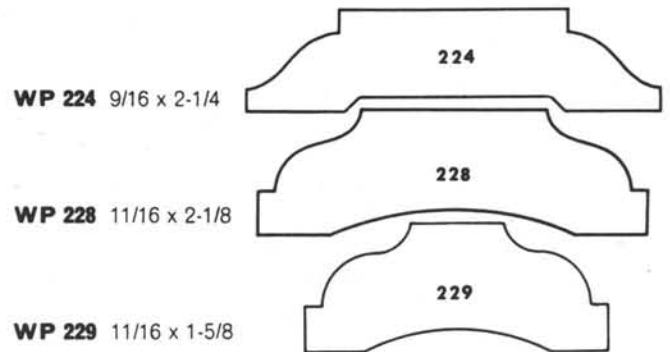

- WP 224** 9/16 x 2-1/4
- WP 228** 11/16 x 2-1/8
- WP 229** 11/16 x 1-5/8

BATTENS

Originally designed to cover joints in board-and-batten siding, these moldings are also applied in mitered frames to flat surfaces, (plywood walls, garage doors) to give the effect of recessed panels.

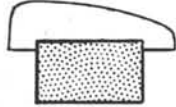

CK-370 Back Relief Knives

Where Back Relief cut is desired, order 370 Back Relief Knives and specify length. Back Relief Knives are made of 1/8-in. thick steel same as planer knives. Use same gib as used with planer knife. Price of Back Relief Knives \$3.00 per inch (per set of three knives).



CK-384 Edge Knife—1-in. long

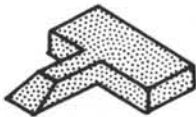

CK-385 Parting Bits—1/4-in.

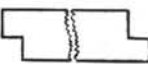

CK-387 Rabbet Knife—1-in.
(specify depth of cut)



CK-389 Tongue & Groove
(2-in. for 2-in. stock)

USING CUSTOM MOLDING KNIVES AND ONE-INCH CUTTER BITS

1. Before using special pattern knives or cutter bits, cover the Planer-Molder Bed (A) with smooth hard wood (B) preferably Cherry or Oak. Extend wood pad (B) through entire length of machine and bolt both front and rear to extension tables.

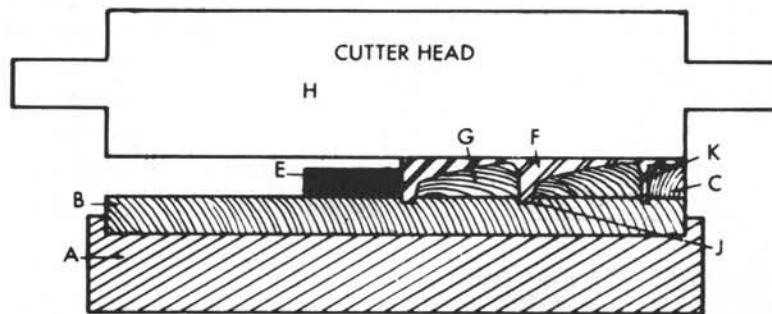

2. Nail or screw a wood guide (C) to the top of wood Bed (B) and line up with outside edge making sure that guide is at 90 degree angle to cutterhead. This permanent guide should be approximately 5/8" square. Extend guide to the front cross bar Number 78. Do the same on the rear from the outfeed roll to the end of the table. Cut a 45 degree bevel on the rear permanent guide so there is no tendency for the stock to hang up on the square corner.

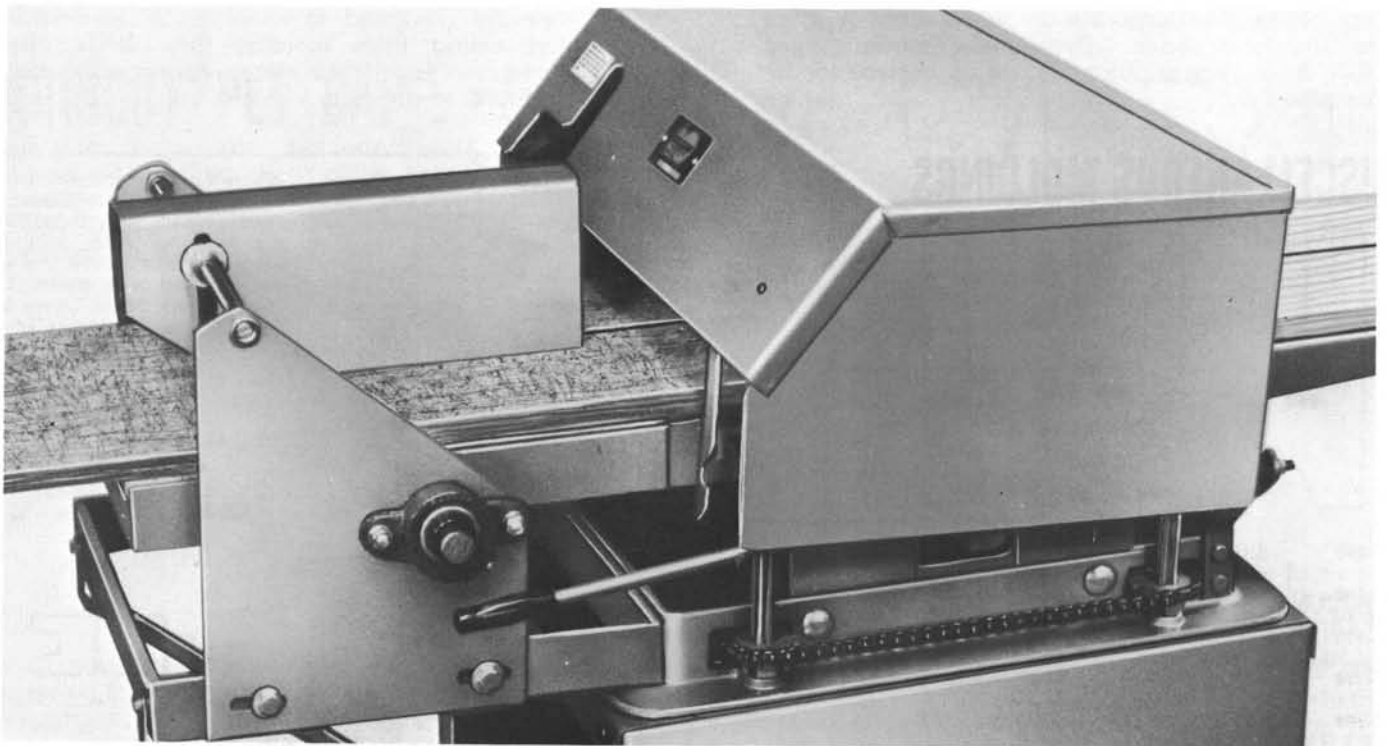

Figure 1

3. Nail or screw a movable guide (E) so stock will travel between it and guide (C) in a straight line. Cut out for clearance where guide contacts cutterhead and both feed rolls to minimum depth 1/4". When running random width stock, movable guide is not used. Stock must travel against permanent guide at all times.

MOLDING ONE-INCH CUTTER BITS

1. Loosen the three center Number 57 Cutterhead Set Screws with 3/16" Socket Wrench. Use a piece of soft metal as a punch and tap gib down into cutterhead. Spacer will then be loose and can be removed.
2. Select the desired pattern of molding cutter bits and fit them into this hole left by spacer so that they have the same cutting direction as the Planer Knives.
3. (a) Align highest cutting edge of cutter bit with cutting edge of Planer Knives.
(b) Tighten Cutter Bits with 3/16" Socket Wrench Pull TIGHT. After a few minutes run, test each set screw for positive tightness.

Should the Cutter Bit crawl up as Gib is tightened, hold bit down with a stick of hardwood against the knife point. Use some portion of the machine as a lever pry.

- (c) You will find just enough extra space between the two Number 70 Long Gibs to permit easy fitting of the Cutter Bits. Be sure to keep each Cutter Bit tight against the end of Number 70 Gib on LEFT (pulley) side. This assures uniform alignment of all three Cutter Bits.

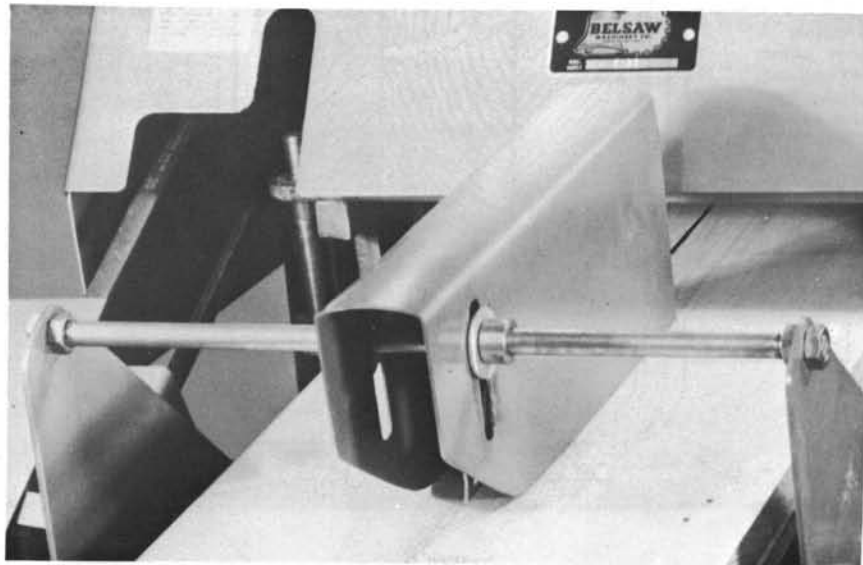

Figure J

4. Depth of molding cut will be determined by elevation of the Planer Bed. Since varying projection of cutter bit patterns make a fixed "stop" impractical, be careful not to raise Bed so that Cutter Bit can contact it.

Some operators add a red warning mark on the 1" line of Scale to remind them to watch elevation carefully from that point on up.

The most practical way to use molding bits is to install a wood pad throughout the entire length of the Bed. (See instructions on using Special Molding Knives).

GUIDES FOR MOLDING CUTS

For face molding, the Stock Guide and featherboard can be combined to position stock for desired pattern cuts. See Figure C. When edge molding, it is better to provide C-clamped wood guide pieces on each side of stock up to within 1/2" of the top edge. This supports narrow stock so that it will travel straight and remain upright. See Figure K.

TYPICAL SET-UP FOR EDGE MOLDING

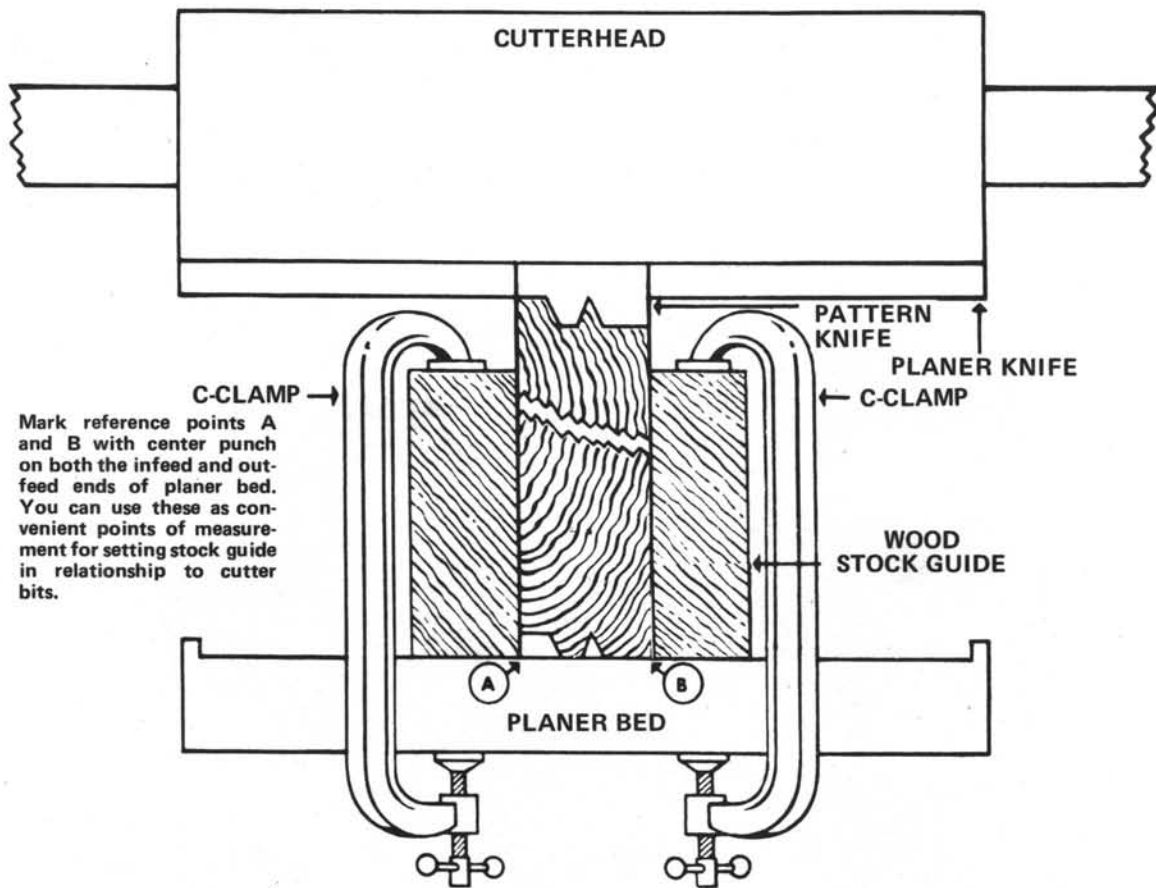

Figure K

MOLDING: USING CUSTOM PATTERN KNIVES

1. Replace Planer Knives and Gibs with pattern knife (F) and gib of equal length in cutterhead (H) using following sequence. . loosen gib set screw, tap gib down to release knife, remove knife, remove gib. Part of pattern knife (K) extends inside permanent guide approximately 1/8" or just enough to clean up the right edge of molding. Always install knives on right (feedworks) side of cutterhead by following steps:

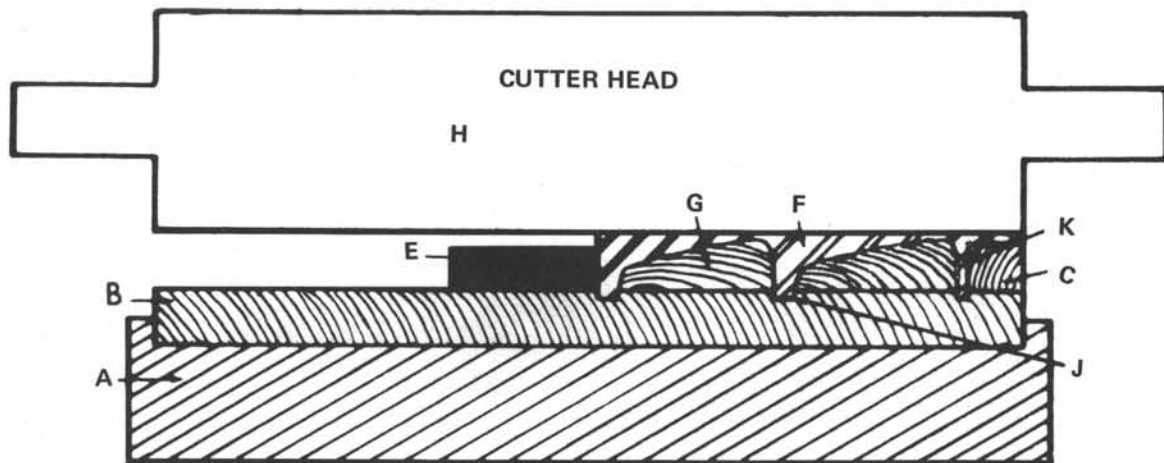

Figure L

- A. Clean cutterhead slot, knife, gibs and counter-balance weights thoroughly to remove all wood dust, gum and protective coatings. Use kerosene or gasoline with care.
- B. Install gib first, then pattern knife in any slot. Tighten gib set screw. Be sure knife does not creep up during tightening, tap it down with hardwood block if necessary.
- C. Install gibs, then counter-balance weights in other two slots. Tighten gib set screws. Counter balance set is ground to balance cutterhead when it is running at recommended speed of approximately 4,100 rpm.

(Balance Weights may be longer than Knife. If so, space Gibs as shown below in Figure M.)

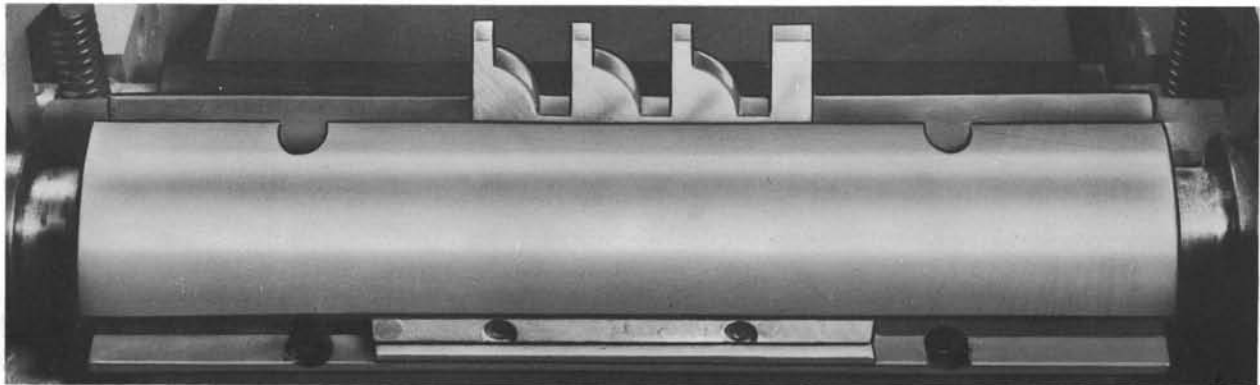

Figure M

- D. Check knife for clearance with chipbreaker by closing planer hood to working position and rotating cutterhead slowly by hand as you raise hood. There must be no contact of knife and chipbreaker. If there is, loosen gib set screw tap gib down and be sure knife is bottomed in cutterhead slot. Retighten gib set screw.
 - E. Check all gib screws to be sure they are tight. Run machine and feed scrap through to check pattern you are making. Stop machine and recheck gib screws.
2. Knives are made so the extreme cutting tips (J) can cut into the wood table by approximately 1/16". This is necessary for parting the stock.
 3. Before operation, apply a liberal amount of paste wax on the hard wood pad and rub it into the wood. Use wax occasionally during operation to facilitate easy feeding of stock.

EDGE KNIFE CATALOG NUMBER 384

S2S Planing can be easily done with your BELSAW on stock up to 3/4" thick and 11" wide, with the following set-up:

1. Install Edge Cutter Knife, Catalog Number 384, at right or left edge of cutterhead so that point (A) extends inside of wood guide (B) approximately 1/16" to 1/8" or just enough to clean up stock. Hold in place with 1" Gib, Catalog Number 386.
2. Install remaining knives in same cutting circle, following steps A through E of special pattern knife instructions. Counter-balance weights are not used with Edge Knives.
3. Cut one inch off of the length of Planer Knives and butt against Edge Cutter Knife. Install Planer Knives as covered under Planer Adjustments.
4. Set Guide E (See Figure 4) to desired width if all stock is the same width.
5. If stock is random width, movable guide is not used. Hold stock against permanent guide (C) if it has a tendency to creep away.

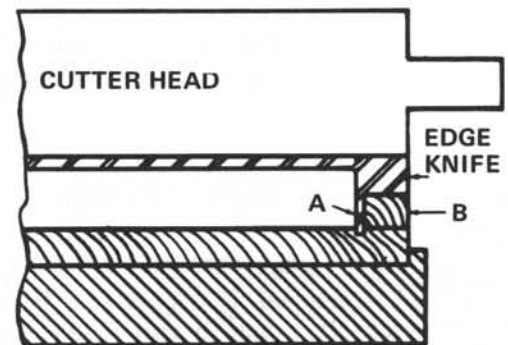

Figure N

NOTE: When Edge Cutter Knives become dull on one side, move them to the opposite side of the cutterhead and butt Planer Knives against other side. When doing this, it will be necessary to install another permanent guide.

PARTING BITS CATALOG NUMBER 385

Install same as pattern knives and use Catalog Number 386 Gibs to hold in place. Position in cutterhead for width of stock desired. Parting Bits Number 385 will do a very smooth job of sawing soft woods up to 3/4" thick. This covers almost all standard lumber yard stock. Bits can be spaced as close as 3/4" apart and up to 10-7/8" apart. Use wood pad and permanent wood guide on Planer Bed same as for special pattern knives. Figure O shows typical set-up for sawing with two sets of parting bits.

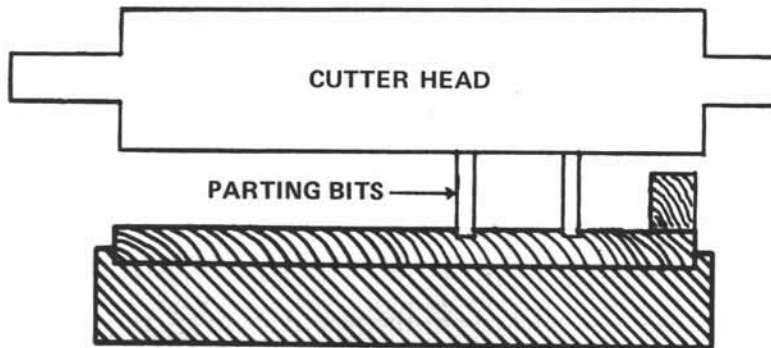

Figure O

MULTIPLE PATTERNS

Many operators who have continuous short runs of several different patterns save set-up time by installing more than one set of knives in the cutterhead at the same time. You can change from one pattern to another simply by changing the guides. This is a great time saver since it eliminates removing and installing another set of knives for a short-run.

Another method of using more than one pattern in the cutterhead at the same time is for producing usable molding from what otherwise would be waste stock. If the width of the pattern being produced is 4-1/2" and the stock is full 5-1/2" wide, you would have a 1" strip of waste stock. This stock can be molded in a separate run or at the same time the original pattern is being run, simply by butting another set of knives against the original pattern knives. This produces two different patterns at the same time.

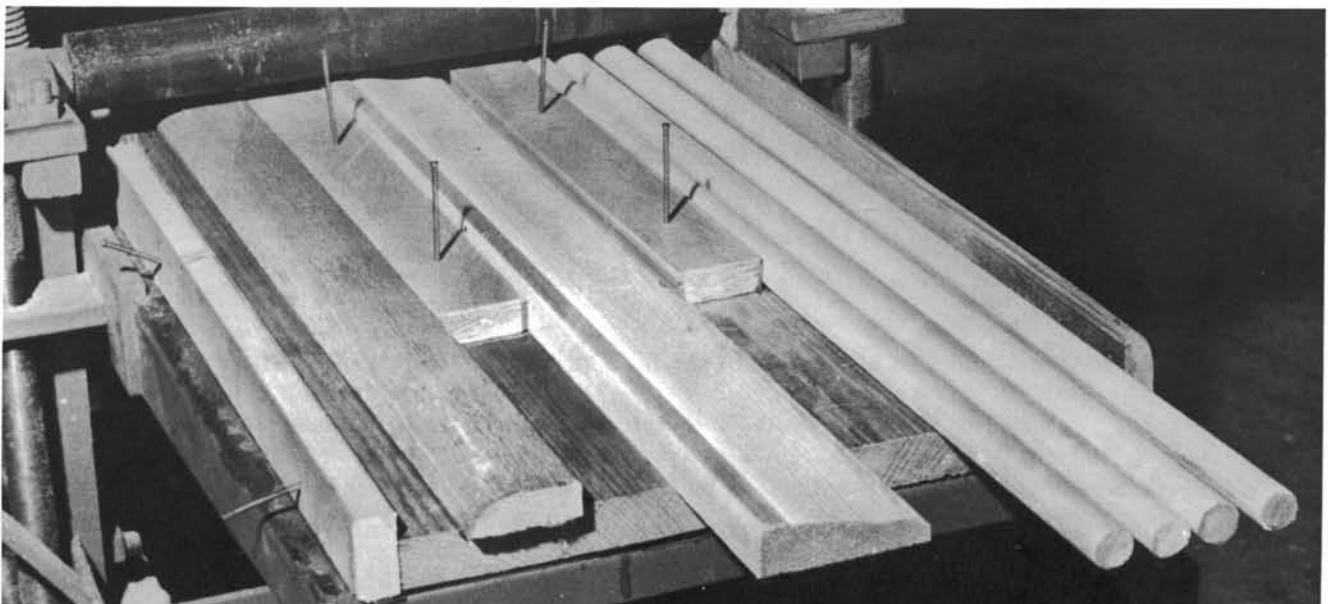

Figure P

(THE PHOTOGRAPH ABOVE SHOWS THE METHOD OF SETTING GUIDES AND KNIVES FOR MULTIPLE CUTTING. DIFFERENT PATTERNS CAN BE MADE IN A SINGLE PASS.)

OPERATING CHECK LIST

This chart is to give you a quick check list of possible operating problems. . .and their correction.

IF BOARD DOES NOT FEED SMOOTHLY

- A – If front feed roll pushes board out, cutterhead is turning the wrong way – reverse motor rotation by instructions on motor plate.
- B – If chipbreaker stops board, it's set too low – bend angles on inside front of hood to raise it.
- C – If feed rolls turn but board does not move, check for wood chip under feed roll bearings between bearings and side castings, or other obstruction – remove it. Remove accumulated resin, etc., from feed rolls with rag moist with kerosene.

IF PLANER VIBRATES AND RUNS NOISY

- A – If motor sheave bored off-center – replace it.
- B – If motor drive v-belts not a matched set, cracked or otherwise defective – replace them. To find out if belts are not matched, run each belt independently.
- C – If motor v-belts too loose – slide motor to tighten them.
- D – If feed roller chain clicks and hops up on sprocket teeth, connecting link is too tight – lubricate and let run in.
- E – Feed handle jumps, tighten #29 spring adjustment nut.

IF PLANED BOARD IS NOT SMOOTH

- A – If revolution marks show, planer knives are not set with uniform projection – loosen gib screws and drive gibs down to take pressure off knives. Turn screws in bottom of cutterhead slots counter-clockwise to raise low knife to equal projection with others. Tighten gib screws.
- B – If a line shows lengthwise on board, there is a nick in knives – remove them and have them sharpened. Knives having bad nicks that do not come out after sharpening can be used by staggering them in the head so nicks are not in same cutting circle.
- C – If knives tear out lumber in spots, grain of board is running against knives – reverse board for next pass.
- D – If moisture content is too high, allow extra drying time.

IF SAW CUT IS NOT SMOOTH

- A – If splinters at edge of saw cut, saw teeth are dull – file tooth points to sharp cutting edge.
- B – If rough saw cut on side of the board, saw teeth have uneven side projection – remove saw and set tooth points half the thickness of the saw blade, uniformly, alternately right and left.

WHAT CAUSES A SNIPE?

A snipe is a cut deeper than the intended line of cut near either end of the board. You can reduce snipe by making sure that stock is substantially supported as it's fed into the machine and as it comes out of the planer. Supporting the stock slightly higher than the bed of the machine will also minimize this problem.

SHOP TIPS

We hope that this material will help both the novice and the experienced woodworker to obtain more profitable results with his Belsaw. Please feel free to criticize any instructions; give us your frank opinion — both good and bad and your suggestions for improving the contents.

Our Service Department will welcome your questions on any woodworking problem or specific questions you have on the operation of your Belsaw. Please feel free to write to our Customer Services Department; Belsaw Machinery Company, 315 Westport Road, Box 593, Kansas City, Mo. 64141.

The following pages contain the most frequently asked questions about the Belsaw. We're sure that you'll find many of the answers to your questions on these pages.

SHOP NOTES

Question—I have a small nick in Planer knives due to hitting a nail. Do I have to have them resharpened completely?

Answer—No. Small nicks such as these are easily corrected. This type knife damage usually nicks the knives in the same cutting circle. A very good way to remedy this is to move one of the knives 3/32-inch to the left and the next knife 3/32-inch to the right. Leave the third knife in its original position. Since the nicks are staggered the second knife will clean up the ridge left by the first knife and the third knife will clean up after the second.

Question—What causes boards to pull up or chip when being planed?

Answer—Always feed boards in the direction that has the planer knives cutting with the grain.

Where the grain or the type of wood does not allow you to follow this rule and the grain of the wood has a tendency to pull up and chip out, the easiest correction is to take a lighter cut.

For long runs against the grain, grind a 10-degree back bevel on the face of the knife.



This reduces the lifting tendency of the knife on the up thrust of the cutterhead circle.

The back bevel of the face of the knife requires a little more power; be sure your motor is adequate before back-beveling your knives.

Question—How do you sharpen molding knives?

Answer—There are three ways to sharpen these knives. First you can hone the flat side of the knife with a small flat oil stone as shown in the drawing. Hone only the section shown.

Do not use the hone on the entire flat section of the knife or it will make the wedge action gib ineffective. Hold the hone flat on a level surface and run the knife

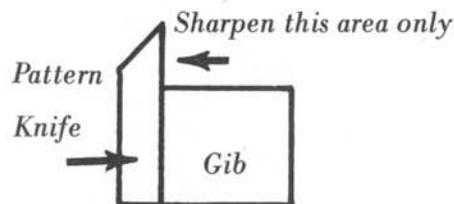

back and forth several times until a sharp edge appears.

If a knife has nicks or is extremely dull you can do a good job of sharpening with a round carborundum stone by working on the beveled edge of the knife.

The third alternative is to return them to the factory for resharpening on the original tem-

plate they were made on.

Any time a pattern knife has been resharpened the pattern contour will change slightly. However, a knife can generally be sharpened several times before the finished product will be noticeably changed.

Generally speaking, these knives should run from 40,000 to 75,000 lineal feet between sharpenings. The life of the knives will depend on the type and condition of the material.

Question—I have no snipe problems when planing, but when I use molding knives a snipe occurs, what causes this?

Answer—A snipe occurs at the end of a board because that last few inches raises off the planer bed after it passes under the infeed roll. This brings it closer to the cutter head so the board is planed thinner in that section.

Since you are planing boards without a snipe, your feed rolls are holding them flat on the planer bed for their full travel. This rules out any misalignment of the outfeed table.

Moldings are generally thinner and lighter in weight than boards, so the outfeed roll plays a more important part in holding them down against the planer bed. If outfeed roll is not holding molding flat to the planer bed, it probably is not working freely in

its milled slot. An accumulation of fine sawdust and gum from certain soft woods may be the reason.

To correct, clean milled slots in planer side casting, feed roll bearings, and tension springs thoroughly with gasoline or kerosene. Oil the slots so bearings move easily up and down. Adjust spring tension if needed.

Question—Can crooked or twisted stock be used for making moldings on the Belsaw?

Answer—Being crooked or twisted, within reasonable limits, will not destroy its value for moldings.

Quite obviously, absolutely straight lumber is much easier to mold and presents very little guiding problem. However, very little lumber is straight as a die. If your lumber is reasonably straight and the molding pattern is fairly simple, the ordinary guides and featherboard arrangements outlined in your Operator's Manual are entirely adequate.

We have reports from customers in the field who tell us they depend entirely upon the small raised portion on the side of the planer bed as their only guide. But should the board be slightly twisted it has a tendency to climb this ¼-inch-high strip and throws the molding off in relation to the board.

Whenever crooked or twisted lumber is encountered, stationary guides on both sides of the stock should be provided and they should be at least two-thirds of the thickness of the stock to prevent such climbing. Adequate feed roll pressure is a must.

Another point to watch closely when molding are those patterns that have work done on both sides of the stock. Moldings of this type are usually sent through the machine in batches and are then brought around to be sent through again for the secondary or backside operation.

On the second operation, care should be exercised to see that the *same* edge of the board is used against the guide, thus making opposite faces match or remain in the proper relationship to each other. A crooked board can be made into absolutely round dowels by turning it over for the second cut and placing the *same* edge against the guide as was used for the *first cut*.

Question—I use my Belsaw Planer on a wide variety of hobby projects, and I'm wondering if you can suggest some guidelines as to which particular species of wood will give me the best results.

Answer—Generally speaking, any wood that has a short, close grain will plane or mold to a smooth finish that will require little or no sanding. Woods with a coarse texture tend to leave a raised grain effect even after careful planing. Select carefully and you will save time and expensive material. We suggest experimenting with a small piece of scrap to make sure you obtain the results you're looking for.

Often you can use a less expensive and more easily obtainable wood that will have the same qualities of a more expensive stock. You can use the following list as a guide to selecting stock for your projects.

SOFT WOODS

Basswood. Light, straight-grained and of fine texture. Easy to work. Suitable for both turning and carving. Used for picture frames, molding, furniture, toys, etc.

Cedar. Light, fine texture, and beautifully grained. Easily worked and finished. Used for moth-proof chests and closets, toys, furniture, and many other purposes.

Cypress. Soft and easy to work. Its rich, reddish brown color makes it particularly well-suited

for furniture. Being strongly weather-resistant, it is extensively used for posts, etc.

Fir. Stiff, strong and of even texture. Has an orange-brown color. Suitable for toys and many other articles of heavy construction.

Gum. Heavy, strong, and of fine texture. Is usually cross-grained. Brown to yellow in color. Easily twists and warps when exposed. Used extensively for interior finish and many small articles.

Poplar. Light, very soft and of fine texture. Gray to yellow in color. Easy to work but not durable. Used for furniture that will not be subjected to rough handling.

Redwood. Light, fairly strong, and takes a fine finish. Sapwood is whitish; hardwood is light red, turning to brown upon exposure. Very durable. Used largely for cabinet work.

White Pine. Very light and soft. Differs greatly in quality. Usually quite durable. If well-seasoned, resists boring insects. Exceptionally easy to work. Uses are almost unlimited.

White Spruce. Light, stiff and fairly strong. Easy to work, and splits well. Used largely for musical instrument sounding boards, but can often be used for same purposes as white pine.

HARD WOODS

Ash. Heavy, strong and tough. Resembles oak, but is coarser grained and easier to work. Gets brittle with age. Takes a fine finish. Suitable for all kinds of furniture.

Beech. Heavy, strong and of coarse texture. Works well and takes a good polish, but tends to shrink and check in drying. Used extensively for furniture.

Birch. Heavy, tough and close grained. Very durable. Frequently stained to imitate black walnut and mahogany. Excellent for lathe turning and furniture.

Chestnut. Light, medium hard, but not very strong. Has a coarse texture. Easy to saw, turn and plane. Inclined to shrink, split and check in drying. Used for cabinet work.

Mahogany. Light to dark reddish brown. Fine grained, with many cross grains. Can be worked easily. Takes beautiful finish. Has many imitations. Used largely for furniture.

Maple. Heavy, strong and very hard. Fine texture, wavy grained. Excellent for carving, turning and scroll work. Widely used for furniture and paneling.

Oak. Very heavy, hard, strong and durable, but shrinks and checks badly. When quarter sawed produces a smooth, attractive finish. Many uses: Furniture, carving, common carpentry, etc.

Walnut. Heavy, hard, and strong. Smooth grained, works well, and takes a fine polish. Used largely for cabinet making, furniture, and as a veneer.

Yellow Pine. Varies considerably. Light, medium hard, and with a smooth but strongly marked grain. Works easily, and is quite durable. Many uses.

Question—"I've just had the planer blades on my Belsaw Planer resharpened, after replacing them in the cutterhead, I've found that at times wood shavings have been pressed between the outfeed roller on the machine and the finished stock as it comes out of the planer. Although the finished molding is smooth, these press marks show up as a different tone when the wood is stained. Could it be that the knives were resharpened incorrectly and this is what is causing this problem?"

Answer—Belsaw has gone to considerable work to make the Belsaw Planer the machine that will produce a finished quality wood without sanding. If chips

from time to time are being pressed into the finished stock as it passes under the outfeed roller, it may be the cause of improper sharpening. Check the knives to make sure that the beveled edge on them is from between 30 to 45 degrees. If the knives are sharpened within this bevel range, it's more likely that the knives have been placed in the cutterhead incorrectly. Check the projection on the planer blades. The blades should extend from 5/32 to 3/16 inch above the cutterhead. Correct projection on all three knives will assure that wood shavings and chips are thrown completely past the feed rollers on your planer so that they can not be pressed into your finished stock.

If you're using your Belsaw to make molding, the chip breaker is of prime importance in removing the wood shavings. The chip breaker should be adjusted so that as you feed the stock into the machine, the wood raises the hold approximately 1/16 inch. If the hold does not raise as you feed the stock through the machine, you should adjust the ears located on the inside of the hood of your Belsaw. Bend the ears up slightly until the chipbreaker contacts the stock to raise the hood the required 1/16 inch.

Belsaw also uses a rubber feed roller on its planers. These feed rollers have been specifically designed so that the rubber is soft enough to absorb any chips that may come between the rollers and the finished stock.

If the above suggestions did not correct the problems you were having with the chip marks, check the feed rollers to make sure that gum or pitch is not built up on them. If this build-up occurs, it may harden the rubber rollers. However, you can easily clean them by using a light coat of kerosene to break down and remove this residue.

Question—Can I obtain good results planing rough sawn moist lumber with the Belsaw?

Answer—Although moisture content, feed rate, cutterhead speed, knife angle, peripheral speed, and power all affect the quality of a planed surface, probably the most significant items are number of knife marks per inch and depth of cut.

Species, of course, has a considerable bearing on quality. As an example, oak will give as good results at 10 knife marks per inch as maple will at 20 knife marks per inch. According to tests performed by the Forest Products Laboratory on yellow poplar, white oak, sweetgum, yellow birch, and hard maple, the group as a whole exhibited the following results:

1. Twelve knife cuts per inch yielded 3½ times as many defect-free samples as six knife cuts per inch.

2. Twenty knife cuts per inch yielded 4½ times as many defect-free samples as six knife cuts per inch.

Your Belsaw Planer gives 80 knife cuts per inch with standard feed speed, so you will get even better results.

The Forest Products Laboratory also ran a number of tests on the effects of depth of cut. Four depths of cut were used on the test samples: 1/32, 2/32, 3/32, and 4/32 in. The shallowest cut gave the best results. The results got progressively worse as the cuts got deeper.

It is interesting to note that the biggest difference in quality was observed between the 1/32 and 2/32-inch cuts.

As usual, the different woods gave different results. For examples, beech and hickory were much more affected by depth of cut than elm and willow.