

# WALKER-TURNER MACHINE TOOLS



BAND SAWS • BENCH SAWS • DRILL PRESSES • FLEXIBLE SHAFT MACHINES • GRINDERS  
JIG SAWS • JOINTERS • LATHES • MOTORS • POLISHING LATHES • SURFACERS • SHAPERS  
RADIAL DRILLS • RADIAL SAWS • TILTING ARBOR SAWS • TRANSMISSION EQUIPMENT

# Engineered FOR INDUSTRY



Walker-Turner machines are enabling thousands of alert manufacturers to meet exacting production schedules, to keep machine investment down and to lower power loads and maintenance costs. Walker-Turner machine tools can do this because they are *correctly engineered* by a staff of highly trained specialists who knowing industry's problems are giving full time to solving them. That they have been successful in contributing in a substantial way is attested by the fact that thousands of industrial plants have adopted Walker-Turner machines and are constantly adding to them. If you want to know, in a definite way, what they are doing for others and can do for you, call in your local distributor. He'll give you the facts.

## Walker-Turner machines are sold only through Authorized Distributors

**NOTE:** Prices shown in this catalog or on separate price list do not apply to parts omitted from standard machines. Under certain circumstances, if it is necessary to order machines less standard parts, a deduction of 50% only on parts prices will be allowed.

Machines, accessories and parts are sold as listed in this catalog. No substitution or interchange of parts or accessories will be made at the factory.

Because of the National Emergency, it may be necessary in the interests of conserving defense materials to discontinue items, make substitutions, or to change the design, construction or materials of machines, parts and accessories listed herein. Walker-Turner reserves the right to do this without notice or imposing any obligation or liability upon itself.

<i>Product</i>	<i>Page</i>	<i>Product</i>	<i>Page</i>
<b>BAND SAWS</b> .....	<b>12 &amp; 34</b>	<b>MOTORS</b> .....	<b>50</b>
<b>BENCH SAWS</b> .....	<b>37</b>	<b>POLISHING LATHES</b> .....	<b>24</b>
<b>DRILL PRESSES</b> .....	<b>3</b>	<b>RADIAL DRILLS</b> .....	<b>8</b>
<b>FLEXIBLE SHAFT MACHINES</b> .....	<b>14</b>	<b>RADIAL SAWS</b> .....	<b>26</b>
<b>GRINDERS</b> .....	<b>22</b>	<b>SHAPERS</b> .....	<b>30</b>
<b>JIG SAWS</b> .....	<b>48</b>	<b>SURFACERS</b> .....	<b>21</b>
<b>JOINTERS</b> .....	<b>42</b>	<b>TILTING ARBOR SAWS</b> .....	<b>38</b>
<b>LATHES</b> .....	<b>44</b>	<b>TRANSMISSION EQUIPMENT</b> .....	<b>55</b>

All prices F.O.B., Plainfield, N. J., unless otherwise noted, and subject to change without notice. Slightly higher at distant points for transportation. Also subject to local, state or federal sales tax wherever such taxes are in

force. The Walker-Turner Company reserves the right to make changes in design, or to make additions or improvements in its products without imposing any obligation upon itself to install them.

# WALKER-TURNER DRILL PRESS HEADS

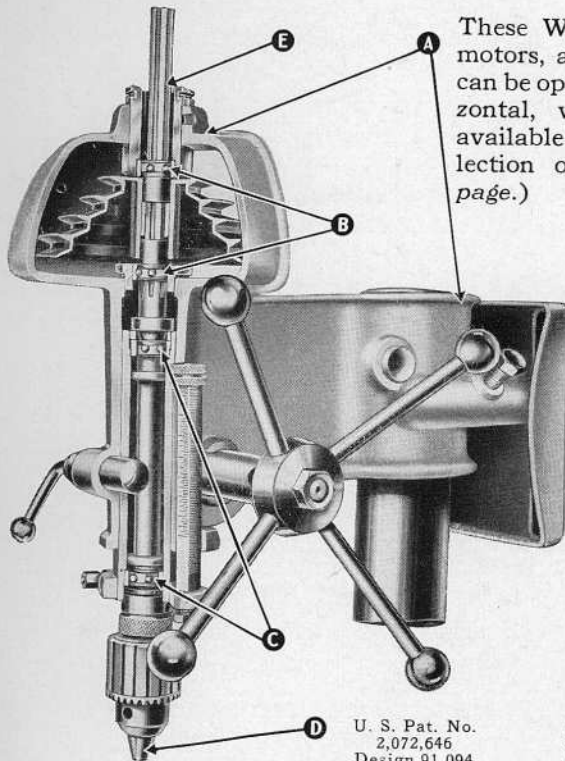

These W-T Drill Press heads with motors, are self-contained units and can be operated in any position—horizontal, vertical or inverted. Also available separately, with a wide selection of attachments. (See next page.)

(A) One-piece head casting, precision bored to assure correct bearing alignment. Note head casting is held in position by wedge, not by split casting and clamp bolt, which destroy accuracy.

(B) Bearings above and below drive pulley take strain evenly, remove all possibility of spindle "whip".

(C) Precision deep-groove bearings used, thrust being taken by upper bearing. Note wide separation of bearings.

(D) Jacobs chuck selected for maximum accuracy. Total run-out 2" from end of chuck guaranteed not to exceed .003".

(E) The Walker-Turner head is so designed that a few drops of oil placed in the cap will lubricate the entire spindle and all four bearings. The lowest bearing is sealed at the bottom against dirt, dust, and abrasive particles.

U. S. Pat. No.  
2,072,646  
Design 91,094

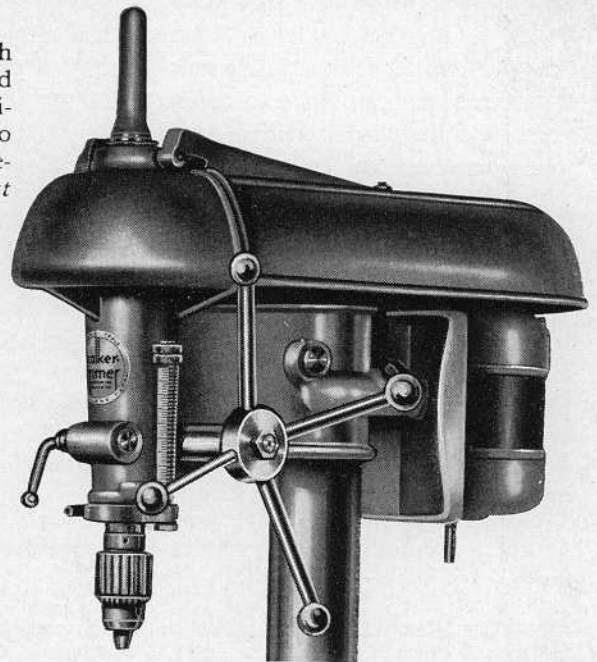

9D13X—Head assembly, as shown above, less motor and belt guard, shipping weight approximately 65 lbs.

9D11—31" x 2 3/4" ground steel column.

9D55—Belt guard.

9D17—Idler assembly (see photos below).

VB92—92" belt for idler drive.

## Special Setups Pay Big Dividends

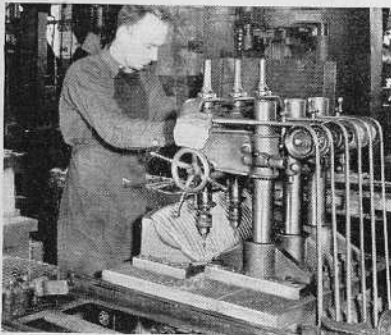

Savings up to thousands of dollars annually are being made by concerns using Walker-Turner drill heads in special setups to side expensive tooling or machinery costs.

The photo at right shows a portable combination unit made up of four standard Walker-Turner drill press heads. This set-up developed by one manufacturer has successfully solved his problem. A hydraulic feed mechanism adds to the efficiency of this machine.

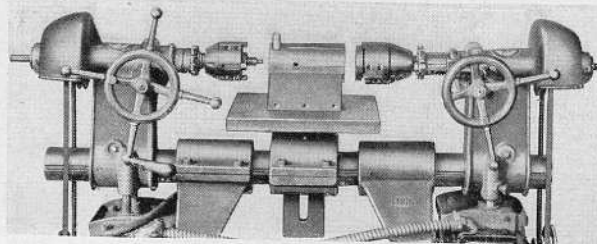

With the set-up above one manufacturer has faced over 280,000 castings without replacement or repair of any part, saving 75% in labor.

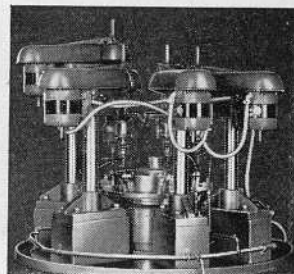

In the set-up below auto radiator grilles are being drilled on a double bank of W-T drill heads. This set-up cost only a fraction of what a conventional set-up would ordinarily cost and has saved its owner thousands of dollars . . . also, it has provided greater flexibility of production.

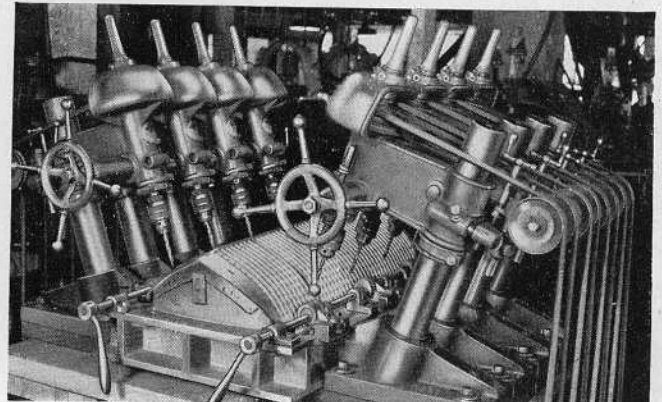

# WALKER-TURNER MACHINE TOOLS

DRILL  
PRESS  
HEADS

# PRODUCTION MODEL DRILL PRESSES

These production model drill presses are designed to cover the widest range of service at new, low levels of investment and operating costs. The vital parts are machined to closer tolerances than similar parts found in other and higher-priced drill presses. Their sturdy construction permits many other operations besides drilling.

Maximum distance chuck to table, 18½".

Maximum distance center of chuck to column, 7½".

Center to center of chucks, 11" on 2 and 4 spindle models. 15" on 3 spindle model.

Machined cast-iron table 17" x 45" on 4 and 3 spindle models; 17" x 23" on 2 spindle model; 14½" x 16" on 1 spindle model.

Heads on multi-spindle models can be swung to right or left independently of each other.

Overall sizes (without legs): Height 42", depth 29" all models. Width, 4 and 3 spindle models, 50"; 2 spindle model, 27½"; 1 spindle model, 20". Shipping weights, less legs, motors and belt guards: 4 spindle model, 570 lbs.; 3 spindle model, 470 lbs.; 2 spindle model, 290 lbs.; 1 spindle model, 160 lbs.

D904—FOUR SPINDLE DRILL PRESS, as shown, less motors and belt guards.

D903—THREE SPINDLE DRILL PRESS, not illustrated, less motors and belt guards.

D902—TWO SPINDLE DRILL PRESS, as shown, less motors, belt guards and stand.

D901—SINGLE SPINDLE DRILL PRESS, as shown,

less motor, head raising mechanism and belt guard.

D901-H—Same as D901 but with 9D75 head raising mechanism.

9D55—BELT GUARD

9D60—CAST-IRON LEGS for multi-spindle models.

(Motors recommended: ½ H.P., 1740 R.P.M.)

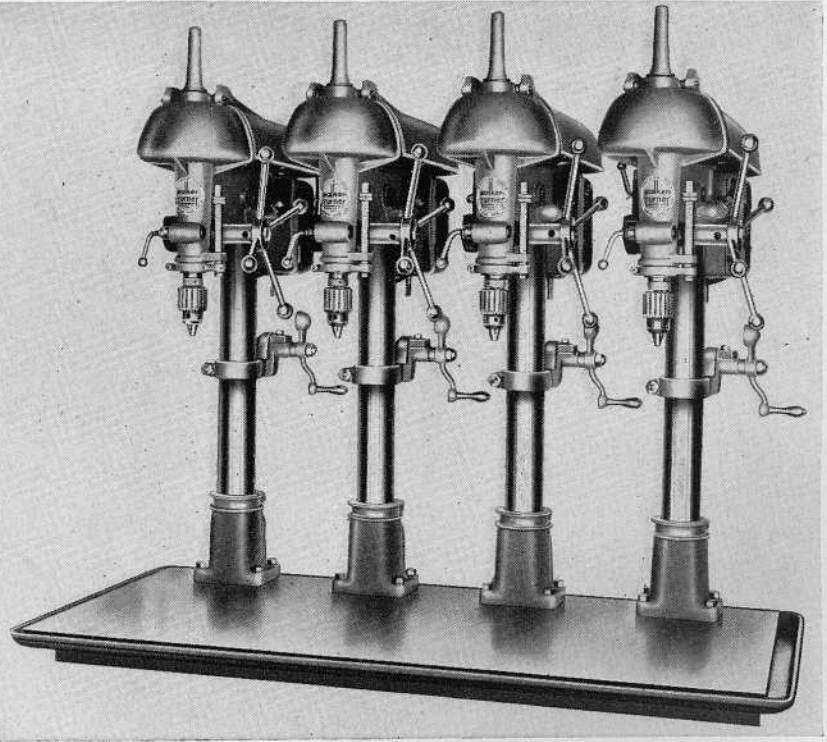
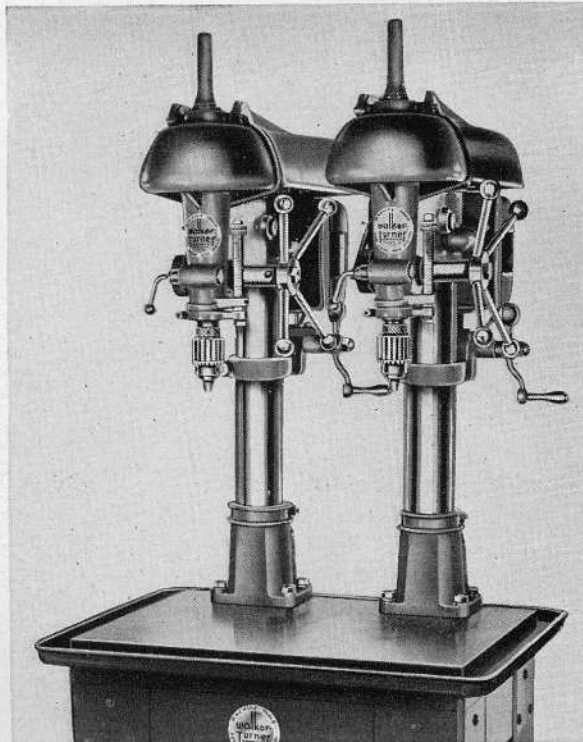
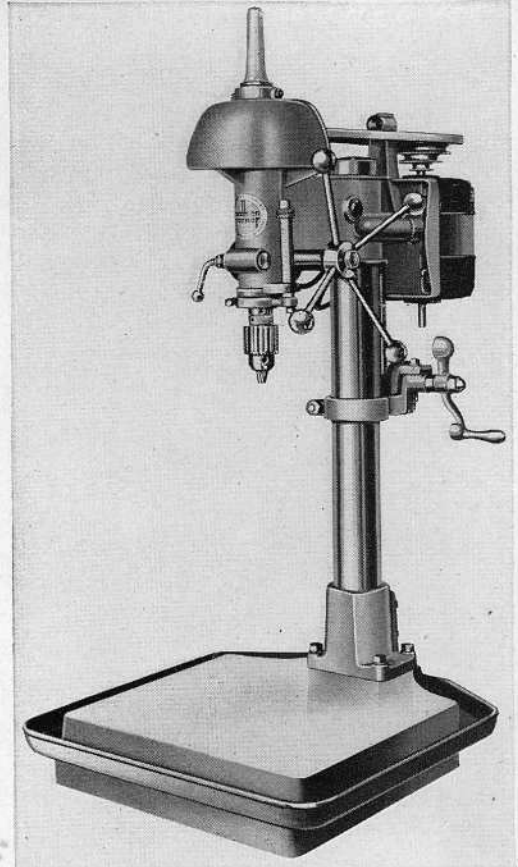

DRILL  
PRESSES

WALKER-TURNER MACHINE TOOLS

# 15" BENCH MODEL DRILL PRESSES

New one-piece table with larger working area.  
 Straddle-mounted pulley design gives extra rigidity.  
 6 spline spindle (pioneered by W-T) minimizes vibration.  
 4 precision ball bearings correctly located.  
 One-piece head casting closely fitted to column.  
 Balanced pulleys nickelized for long wear (W-T feature).  
 Jacobs 0-1/2" key chuck regular equipment.  
 Guaranteed accuracy greater than higher-priced machines.

Experienced shop men find these modern, efficient machines far ahead of the field . . . in design, in accuracy and in value. A study of the cutaway section of the head, page 3, shows why Walker-Turner Drill Presses perform better and last longer. Husky head construction, calibrated depth stop, positive locking device and Jacobs chuck are typical refinements. The chuck collar which permits swinging the head, conveniently located motor switch and belt guard are shown.

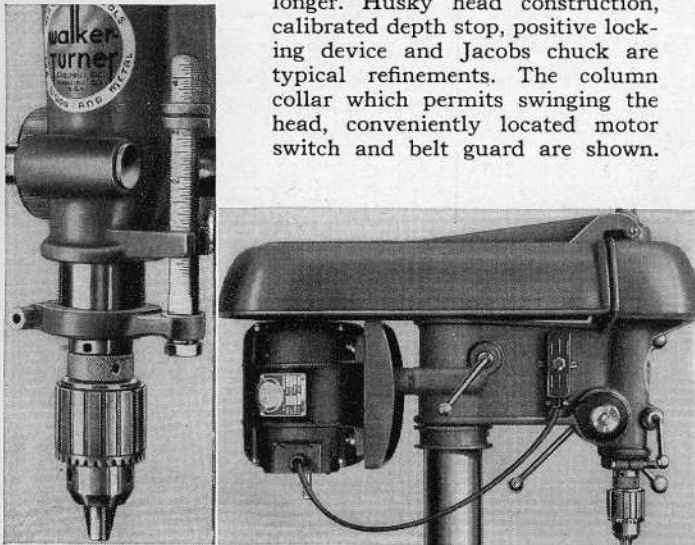

## SPECIFICATIONS

**CAPACITY:** chuck to table 12" . . . chuck to base 17 1/2" . . . center of chuck to column 7 1/2", drills to center of 15" circle.

**CHUCK:** Jacobs key type, 0-1/2" capacity.

**TABLE:** new one piece type with larger working area 10" x 12 1/2".

**BEARINGS:** 4 precision ball bearings mounted one above and one below pulley; other two in rack.

**BASE:** heavy casting with machined surface 10" x 9".

**SPINDLE:** 6 spline, 5/8" dia. tapered for Jacobs chuck and collets.

**SPINDLE TRAVEL:** 3 5/8" adjustable spring return.

**COLUMN:** precision ground, 2 3/4" diameter.

**RACK:** machined from solid bar steel, 1 1/8" diameter. Teeth milled in rack to match pinion.

**PILOT WHEEL FEED:** bakelite knobs, calibrated depth stop.

**HEAD:** close grained gray iron. Parts machined to close tolerances.

**ADAPTER:** No. 1 Morse Taper adapter available.

**STANDARD SPEEDS:** with 1740 R.P.M. motor, 600, 1250, 2440, 5000.

**SLO-SPEED MODEL SPEEDS:** 480, 940, 1300, 2900 R.P.M.

**OVERALL MEASUREMENTS:** height 39 1/2", width 10", depth 25".

**SHIPPING WEIGHT:** 133 lbs. without motor.

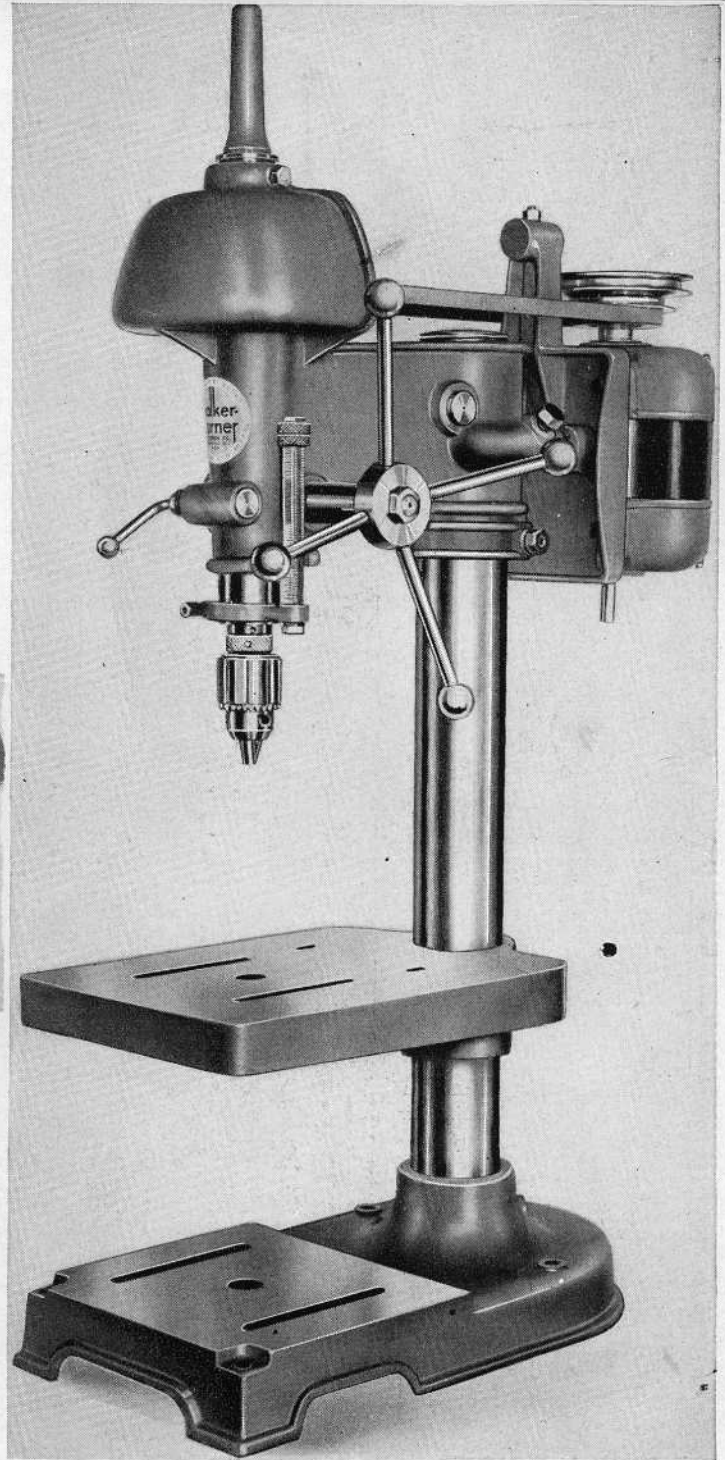

U. S. Pat. No. 2,072,646 Design Pat. No. 91,094

**D950**—As shown above, standard speeds less motor.

**D951**—Same as D950 excepting that it is slower speed (see specifications).

*Motor recommended 1/2 H.P., 1740 R.P.M.*

# WALKER-TURNER MACHINE TOOLS

**DRILL  
PRESSES**

# DRILL PRESS ATTACHMENTS

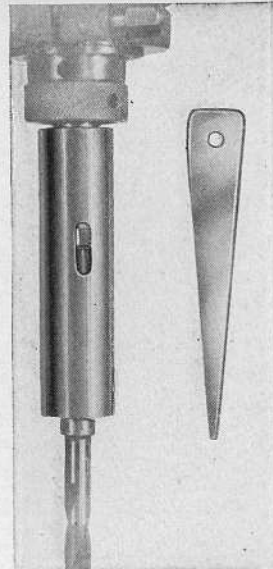

**9MT1**—Morse Taper adapter including drift pin as shown. With this adapter attached to any series "900" drill press spindle in place of chuck, No. 1 Morse Taper shank drills may be used.

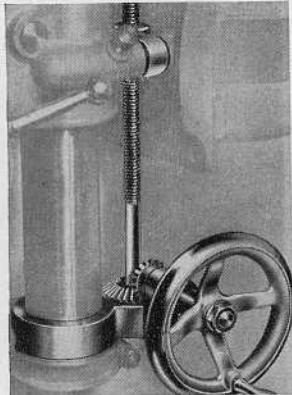

**9D75**—Head raising mechanism (for bench model).

**9D76**—Head raising mechanism (for foot feed floor model). Fits all "900" series drill presses with  $2\frac{3}{4}$ " columns. Functions with head and column in any position. Positive action, easy to operate. Raising and lowering mechanism movable around column with head assembly. Hand crank instead of wheel shown.



Walker-Turner Drill Presses are designed to perform several operations adequately and efficiently. With the proper attachments mortising, shaping, routing, dovetailing and similar wood-working operations can be performed. Also used for tapping, rivet-spinning, and light milling. The attachments shown definitely increase the versatility and utility of Walker-Turner drill presses, enabling the owner to get more service without increasing machine investment.

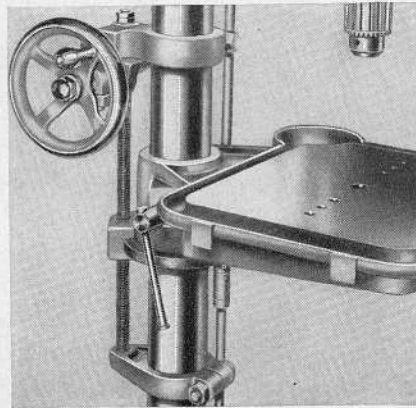

**9D65N** — Production table.

**9D66** — Table raising mechanism (with hand crank instead of wheel shown).

A production table 12" by 10" is shown with the new table raising and lowering mechanism. They fit any drill press with  $2\frac{3}{4}$ " in. diameter column and are very easily attached.

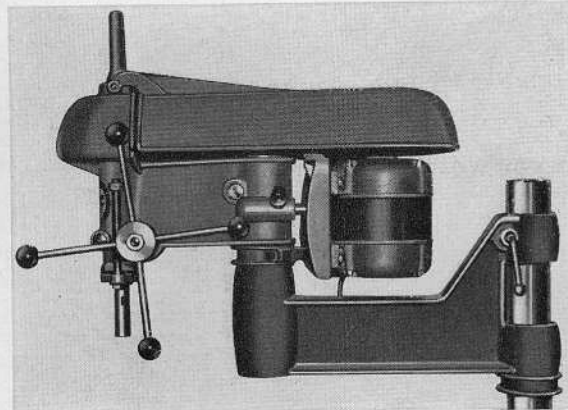

**9D6**—Extension Arm complete.

The extension arm increases the distance between the main column and the drill to 24". Intended for light drilling, it is useful for drilling or tapping holes in large sheets, plates and other wood or metal panels. For use on all bench model drill presses with  $2\frac{3}{4}$ " columns. Swings on accurately fitted bearings and is movable up and down the column.

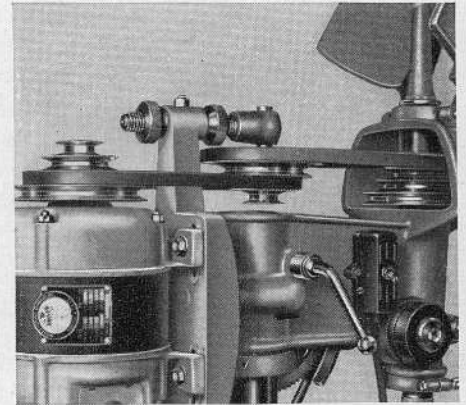

**9D113** — Slo-speed attachment, including ball bearing mounted pulley and 2 24" V belts.

**9D111** — Motor plate for 9D113 (for older models).

This new drive provides speeds of 165, 365, 385, 785, 800, 3260, 3600, 3700, 6700, 6750 R.P.M. The pulley assembly attaches to the motor base bracket now standard equipment on "900" drill presses except slow speed models. Adjustable belt tension. 9D111 not included. The pulley turns on dust-sealed, precision ball bearings. This attachment may be fitted to the older "900" models if old motor plate is replaced by new type listed below. The photo above shows how the attachment is installed.

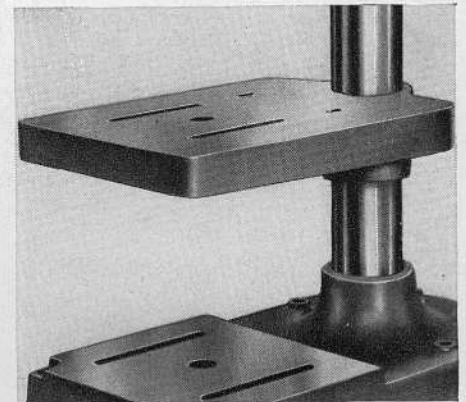

**9D125**—One-piece Table (fits  $2\frac{3}{4}$ " diam. cols.). Supplied as regular equipment on standard bench and floor models is a new sturdy one-piece table with  $12\frac{1}{2}$ " x 10" machined working surface providing greater usable table area. The table is locked in position on the column by a conveniently located clamp lever.

## HIGH SPEED TAPPING ATTACHMENTS

NO.	GENERAL CAPACITY	CAPACITY IN			STEEL	MAXIMUM-SPEED	WEIGHT
		BRASS	ALUMINUM	CAST IRON			
1B	No. 6 to $1\frac{1}{4}$ " taps	$\frac{3}{8}$ "	$\frac{3}{8}$ "	$5/16$ "	$1\frac{1}{4}$ "	1800 R.P.M.	$5\frac{1}{2}$ lbs.
2B	No. 10 to $\frac{3}{8}$ " taps	$1\frac{1}{2}$ "	$1\frac{1}{2}$ "	$7/16$ "	$\frac{3}{8}$ "	1200 R.P.M.	$8\frac{1}{2}$ lbs.

DRILL PRESS  
ATTACHMENTS

WALKER-TURNER MACHINE TOOLS

# FLOOR MODEL DRILL PRESSES

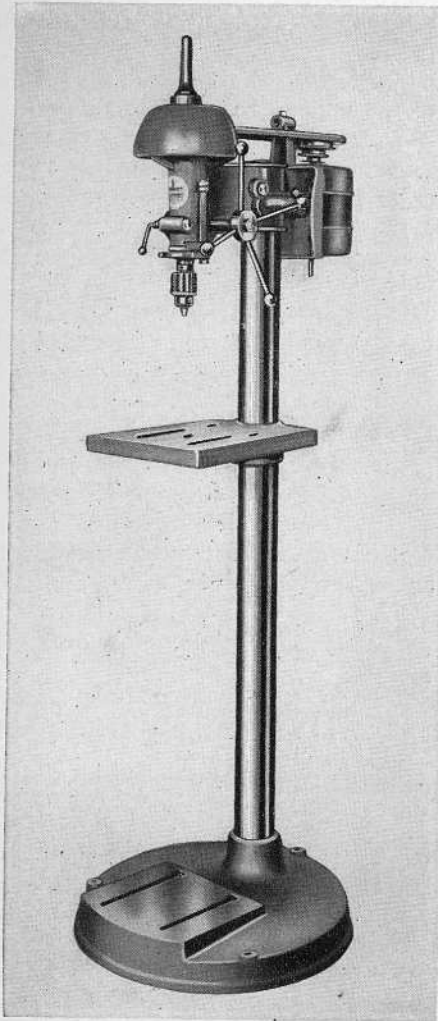

Floor models have the same head assemblies as the bench models. Columns are 60" in length. Single, positive action foot-feed is easily attached to all floor models. Head and table may be swung to various positions around column.

**Distance chuck to base 46".**

**Round base affords greater portability.**

**6 spline spindle, 3 $\frac{5}{8}$ " travel.**

**Balanced, nickelized pulleys for long wear.**

**Foot-feed available at slight extra cost.**

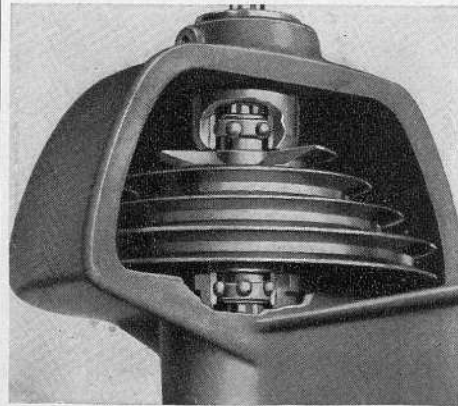

**CORRECT BEARING SUPPORT**—The straddle-mounted construction of the W-T head with ball-bearings directly above and below the pulley gives proper support to the pulley. The spindle "floats" freely through the pulley with no belt strain transmitted to the spindle.

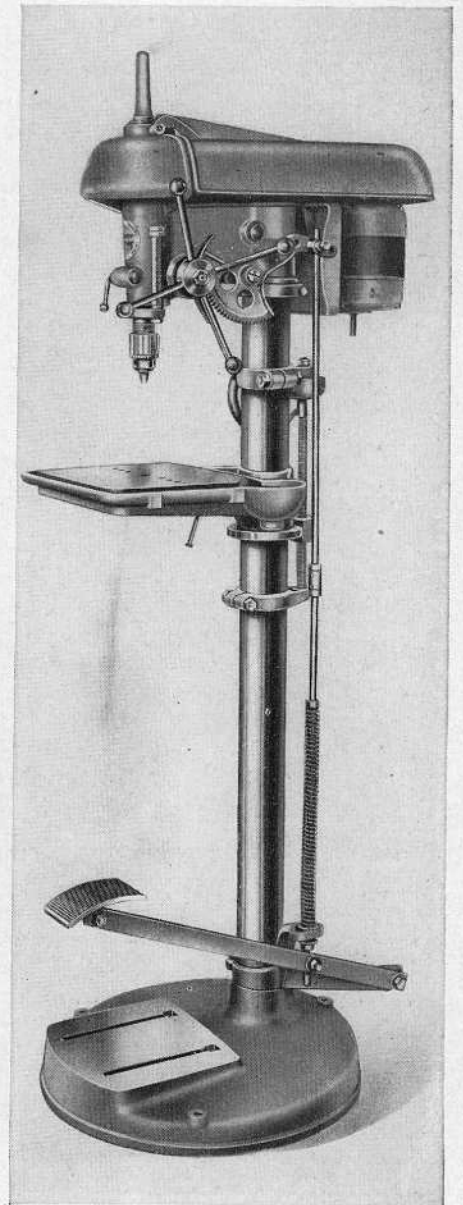

U. S. Pat. No. 2,072,646. Design Pat. No. 91,094.

## SPECIFICATIONS

**CAPACITY:** Chuck to base 46", center of chuck to column 7 $\frac{1}{2}$ ", drills to center of 15" circle.

**CHUCK:** Jacobs key type, 0- $\frac{1}{2}$ " capacity.

**TABLE:** new one piece type with larger working area 10" x 12 $\frac{1}{2}$ ".

**BEARINGS:** 4 precision ball bearings mounted one above and one below pulley; other two in rack.

**BASE:** 22" in diameter. Has machined working surface 10" x 9".

**SPINDLE:** 6 spline,  $\frac{5}{8}$ " diameter tapered at end for Jacobs chuck and collets.

**SPINDLE TRAVEL:** 3 $\frac{5}{8}$ ", adjustable spring return.

**COLUMN:** Precision ground, 2 $\frac{3}{4}$ " diameter.

**RACK:** machined from solid bar steel, 1 $\frac{1}{8}$ " diameter. Teeth milled in rack to match pinion.

**PILOT WHEEL FEED:** with bakelite knobs, calibrated depth stop.

**HEAD:** close grained gray iron. Parts machined to close tolerances.

**ADAPTER:** number 1 Morse Taper adapter available to fit tapered spindle.

**STANDARD SPEEDS:** with 1740 R.P.M. motor, 600, 1250, 2440, 5000.

**SLO-SPEED MODEL SPEEDS:** 480, 940, 1300, 2900 R.P.M.

**OVERALL MEASUREMENTS:** height 69", depth 25".

**SHIPPING WEIGHT:** Approximately 200 lbs. without motor.

**D935**—As shown left above, less motor.

**D937**—Same as D935 but Slo-speed.

**9D80N**—Foot-feed attachment, fits floor models with 2 $\frac{3}{4}$ " columns.

**D936**—With belt guard, production table, Standard speed.

**D938**—Same as D936 but Slo-speed.

**FD961**—As shown at right above, less motor. Standard or Slo-speed optional. Shipping weight without motor: 265 lbs.

*Motor recommended,  $\frac{1}{2}$  H. P. 1740 R.P.M.*

# WALKER-TURNER MACHINE TOOLS

DRILL  
PRESSES

# RADIAL DRILL • FOR DRILLING •

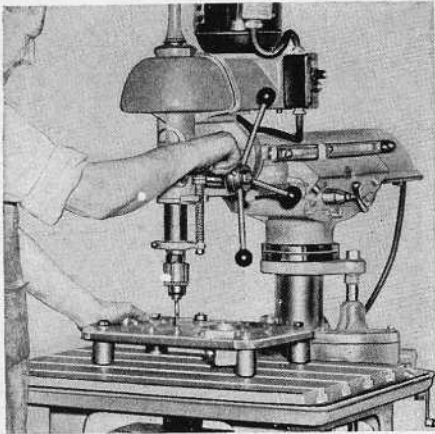

In the toolroom or on the production line the W-T Radial Drill performs drilling, tapping, routing, light profiling and other such operations with speed and accuracy.

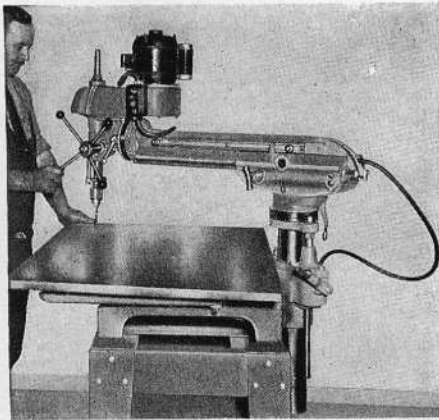

The unusual range of the W-T Radial Drill is illustrated here. This machine will drill to the center of a 62" circle.

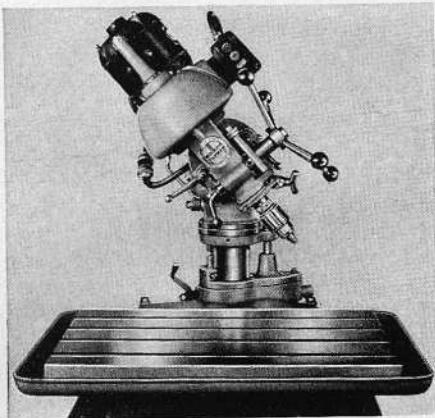

Angle drilling with the W-T Radial Drill. Head tilts up to 45° right or left.

The Walker-Turner Radial Drill makes available to industry for the first time a low-cost radial drill for performing light duty operations.

Because the W-T Radial performs such operations as drilling, tapping, routing and light profiling with speed and accuracy, it is finding wide use in the aircraft industry for stack-drilling sheets, spars, etc.; by tool makers for jig drilling and pattern making; by shipbuilders for drilling metal plates and sheets; in the electrical industry for drilling switchboard panels, etc.; and in countless industrial plants for a variety of operations.

The versatility, accuracy and ease of operation of the W-T Radial Drill are due to its construction.

The drill head is mounted on a heavy cast-iron ram which rolls back and forth in a supporting "cradle" on eight precision ball bearings. This permits rapid adjustment, forward or back, and reduces lost motion to a minimum. The ram can be quickly locked in any desired position with a quarter turn of the conveniently located clamp lock.

The drill head, ram and cradle swing easily right and left on a machined collar mounted on the top of the raising and lowering column. A clamp lock permits locking the drill in position quickly and easily.

The drill head ram and cradle are raised and lowered by a crank-operated screw mechanism mounted on the side of the supporting column. A clamp lock is provided here also.

The W-T Radial Drill can be rigidly locked in position, and operates with a minimum of deflection.

Added versatility is secured in the W-T Radial in that the drill head can be tilted up to 45° either right or left, and securely locked in position.

**THIS CHART  
ILLUSTRATES  
THE UNUSUAL  
CAPACITY RANGE OF  
THE WALKER-TURNER  
RADIAL DRILL**

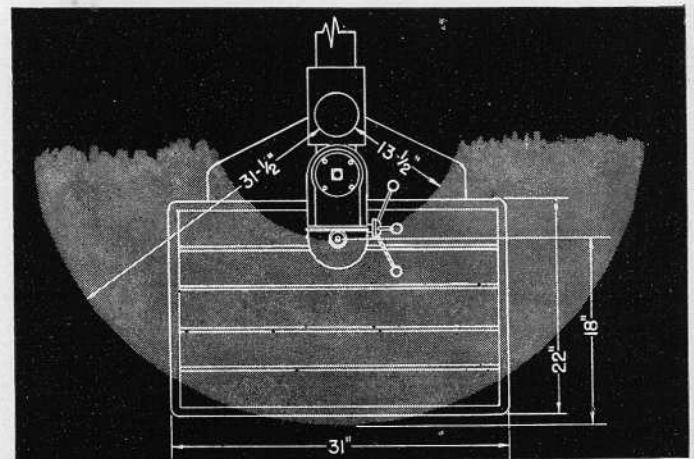

## S P E C I F I C A T I O N S

JACOBS CHUCK, 0 to 1/2" capacity. Morse Taper Adapter available.

TABLE SIZE: 31" x 22". Machined surface, 28" x 19".

OVERALL DIMENSIONS: Height: 68 1/2"; Width: 31"; Depth: 58".

SHIPPING WEIGHT: 450 lbs.

SPINDLE SPEEDS: Four speeds from 600 to 5000 R.P.M. with 1740 R.P.M. 1/2 H.P. single phase motor.

Eight speeds from 600 to 10000 R.P.M.

with two-speed 1740-3500 R.P.M. three-phase motor with push-button control.

CHUCK TO TABLE: Maximum distance, 13 1/2".

VERTICAL TRAVERSE OF SPINDLE: 3 5/8".

COLUMN TO DRILL CENTER: Maximum distance: 31". Minimum distance: 13".

MAXIMUM TRAVERSE OF RAM: 18".

**RADIAL  
DRILL**

**WALKER-TURNER MACHINE TOOLS**



# • TAPPING • LIGHT PROFILING

The Walker-Turner Radial Drill is available with a variety of motors providing spindle speeds for every requirement. The following table lists the speed ranges obtainable with various R.P.M. motors.

MOTOR R.P.M.	SPINDLE SPEEDS			
	BELT POS. 1	BELT POS. 2	BELT POS. 3	BELT POS. 4
1140	390	820	1600	3250
*1450	490	1000	2000	4150
1750	600	1250	2440	5000
3450	1180	2450	4800	10000

\* 50 Cycle Motor Only.

Motors available for use with the W-T Radial Drill are as follows:

**RKAB5 MOTOR**— $\frac{1}{2}$  H.P.; 1750 R.P.M.; 60 cycle; 110/220 volt; single phase.

**RKEB5 MOTOR**— $\frac{1}{2}$  H.P.; 3450 R.P.M.; 60 cycle; 110/220 volt; single phase.

**RPAB5 MOTOR**— $\frac{1}{2}$  H.P.; 1750 R.P.M.; 60 cycle; 220 or 440 volt; 3 phase.

**RPEB5 MOTOR**— $\frac{1}{2}$  H.P.; 3450 R.P.M.; 60 cycle; 220 or 440 volt; 3 phase.

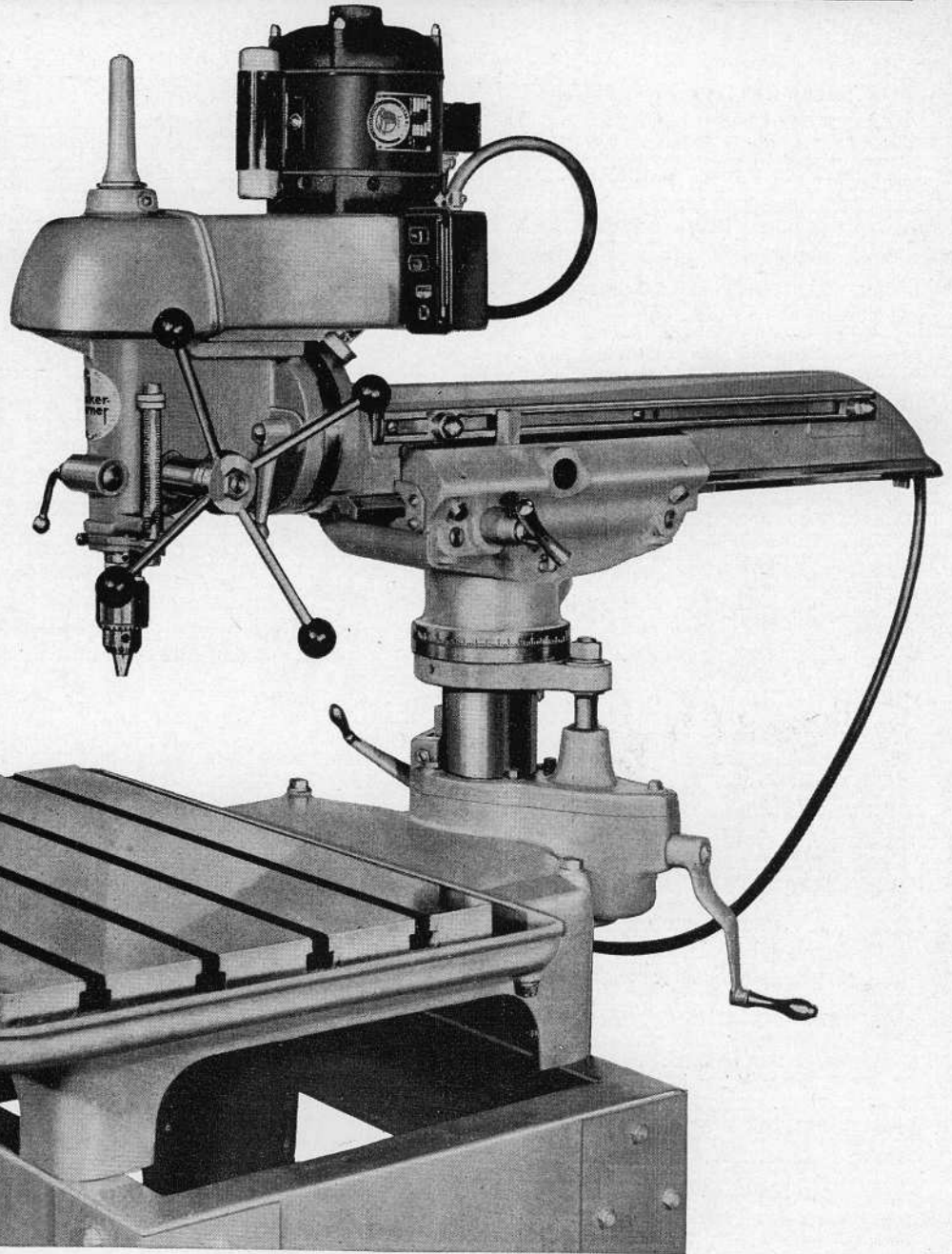

**RPAEB5 TWO-SPEED MOTOR**— $\frac{1}{2}$  H.P.; 1750/3450 R.P.M.; 60 cycle; 220 or 440 volt; 3 phase.

**RPAB5 TWO-SPEED MOTOR**— $\frac{1}{2}$  H.P.; 1450/2850 R.P.M.; 50 cycle; 220 or 440 volt; 3 phase.

**RPOB5 MOTOR**— $\frac{1}{2}$  H.P.; 1140 R.P.M.; 60 cycle; 220 or 440 volt; 3 phase.

**RPEB5 MOTOR**— $\frac{1}{2}$  H.P.; 1450 R.P.M.; 25 cycle; 220 or 440 volt; 3 phase.

**RKEB3 MOTOR**— $\frac{1}{2}$  H.P.; 1450 R.P.M.; 25 cycle; 110/220 volt; single phase.

Note that 2-speed motors are available. These have a double winding, controlled by an interlocking switch, affording the operator the choice of two motor speeds, changeable at the pressure of a button.

**RD-1170**—RADIAL DRILL as shown, less motor and steel stand.

**RA-310**—STEEL STAND, size 27" wide x 23" deep x 26 $\frac{1}{2}$ " high.

**RD-311X**—RADIAL DRILL HEAD ONLY

**9MT1**—No. 1 MORSE TAPER ADAPTER including drift pin

## WALKER-TURNER MACHINE TOOLS

RADIAL  
DRILL

# DRILL PRESS ACCESSORIES

## MORTISING CHISELS AND BITS

**STANDARD** (for the workshop)  
These chisels are made from high carbon tool steel, carefully heat-treated and hardened. Used on "700" and "900" Drill Presses.

HC25— $\frac{1}{4}$ " Hollow	HC25A— $\frac{1}{4}$ " Bit
HC38— $\frac{3}{8}$ " Hollow	HC38A— $\frac{3}{8}$ " Bit
HC50— $\frac{1}{2}$ " Hollow	HC50A— $\frac{1}{2}$ " Bit

### SPECIAL (for commercial use)

These chisels will hold their keen edges longer and give extra hours of continuous, uninterrupted service. The standard bits listed above are used with these chisels.

HCS4— $\frac{1}{4}$ " Special	HCS8— $\frac{1}{2}$ " Special
HCS5— $\frac{3}{8}$ " Special	HCS5A— $\frac{3}{8}$ " Bit
HCS6— $\frac{3}{8}$ " Special	(for HCS5).

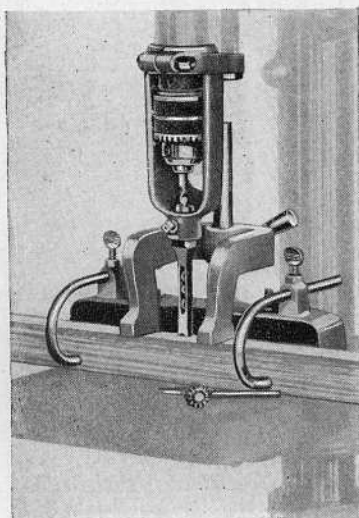

### MORTISING ATTACHMENT

This attachment in place of the stop collar holds hollow chisels permitting mortises of  $\frac{1}{4}$ ",  $\frac{5}{16}$ ",  $\frac{3}{8}$ " or  $\frac{1}{2}$ " to be made in any wood.

9D95—For Series 900 Models.

7D85—For Series 700 Models.

### HOLD-DOWN AND GUIDE

Sturdy and readily adjustable this hold-down and guide may be locked in position just above the piece to be mortised to prevent it from being lifted on the upward movement of the chisel.

9D90—Hold-down and Guide (for "700" and "900" drill presses) (illustrated).

### GRINDING SHAPE

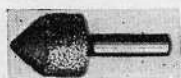

Ideal for sharpening hollow mortising chisels.

D—Aluminous oxide stone.

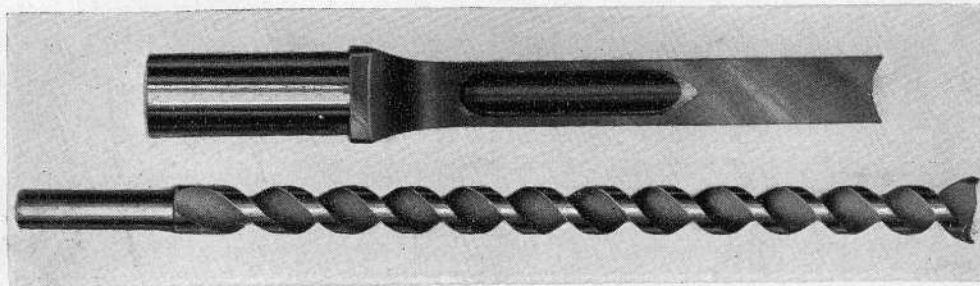

## CARVING AND SHAPING ATTACHMENTS

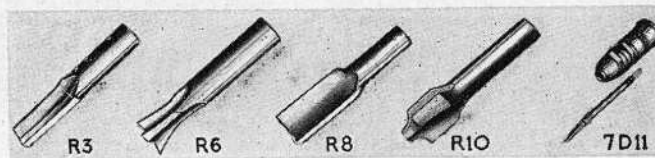

### ROUTING

R1— $\frac{1}{8}$ " Router bit.  
R2— $\frac{1}{4}$ " Router bit.  
R3— $\frac{3}{8}$ " Router bit.  
R4— $\frac{1}{4}$ " Dovetail bit.

### CARVING

R5— $\frac{3}{8}$ " Dovetail bit.  
R6— $\frac{1}{2}$ " Dovetail bit.  
R8— $\frac{5}{8}$ " Router bit.  
R9—1" Router bit.

### DOVETAILING

R10— $\frac{1}{2}$ " Carving bit.  
R12— $\frac{3}{4}$ " Carving bit.  
7D11—Collet Chuck.  
DP118—Collet Chuck.

Attached to drill press with collet chuck (7D11). All bits have  $\frac{5}{16}$ " shanks.



### CARVING CUTTERS

These cutters are made of highest quality carbon steel and are ideal for fine routing and carving.

CR8—Saw.	CR12—Pointed.
CR9—Round.	CR13—Cylindrical.
CR10—Flame.	CR20—Set of 6 Burrs
CR11—Inverted Cone.	( $\frac{1}{8}$ " shanks).

### DRILL SELECTOR AND EIGHT DRILLS

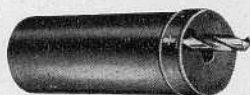

Eight high quality carbon steel drills—in a unique metal container—at a lower price than you would ordinarily pay for drills alone. Sizes  $\frac{1}{16}$ ",  $\frac{3}{32}$ ",  $\frac{1}{8}$ ",  $\frac{5}{32}$ ",  $\frac{3}{16}$ ",  $\frac{1}{4}$ ",  $\frac{5}{16}$ ",  $\frac{3}{8}$ ".  
TD117—Drill Selector with 8 drills.

### DRILL PRESS ADAPTERS

DP120 (Left) —  $\frac{3}{8}$ " ADAPTER for small cutters (SS5 to SS9 shown on page 31).  
9D5 (Right) —  $\frac{1}{2}$ " ADAPTER for large shaper cutters.

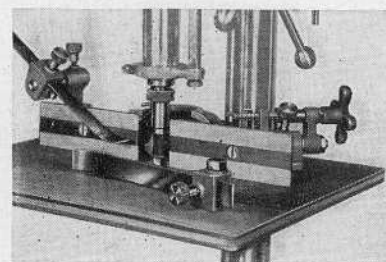

### TABLE FOR SHAPING

This large five-ply wood table, fitted with threaded metal inserts for holding the shaping guard and guides greatly increases the convenience of shaping on the drill press. It is attached to the top of the regular drill press table. Fits both Series 700 and 900 drill presses. Size 18" x 14 $\frac{5}{8}$ ".

9D3—Wood Extension Table for Shaping.

**GUARDS & GUIDES**—For accurate work this attachment is almost indispensable. It restricts the depth of cut to a prescribed point. The front guide has a micromatic setting for adjustment. (Used only with 9D3.)

557—Shaping Guard and Guides.

**HOLD-DOWN SPRINGS**—These springs used with the guard and guides increase the safety and accuracy of shaping.

558—Set of Spring Hold-downs.

558X—Set of Spring Hold-downs for S-975 and S-750 Shapers.

DRILL PRESS  
ACCESSORIES

WALKER-TURNER MACHINE TOOLS

# 13" DRILL PRESS

Jacobs key chuck supplied as regular equipment.

6 spline spindle, full-floating type,  $\frac{5}{8}$ " diameter, tapered at lower end for Jacobs chuck.

4 precision ball bearings, one mounted directly above pulley, other directly below, other two in rack or quill.

Head and table both movable up and down column.

Adjustable depth stop with indicator simplifies drilling a series of holes to identical depth.

Superior method of clamping quill, table, collar and head in position prevents any possibility of the clamping device marring the finely ground surfaces of column or quill.

New one-piece table with larger working area.

Special motor base for multi-speed attachment included in regular equipment.

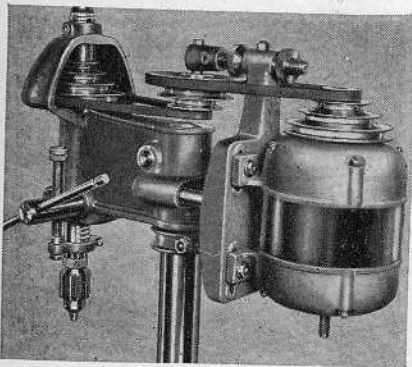

**SLO-SPEED ATTACHMENT**—Provides speeds of 165, 365, 385, 785, 800, 3260, 3600, 3700, 6700, 6750 R.P.M. Pulley assembly attaches to motor base bracket, now standard equipment on "700" drill presses. Belt tension is adjustable. Photo at left shows how attachment is installed.

**7D113**—Slo-speed attachment, including ball bearing mounted pulley and 24" and 26" V belts.

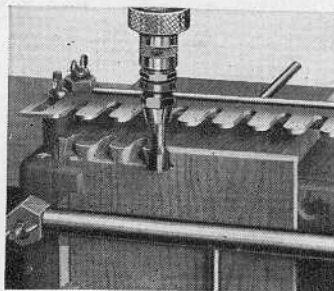

**DOVETAIL JIG (Right)**—Makes  $\frac{1}{2}$ " dovetail joints easily, accurately. Both male and female members of joint are cut simultaneously. Available for  $\frac{1}{2}$ " only. 7D11 collet chuck is used with this jig for dovetailing.

**DV10**—Dovetail jig complete including R6  $\frac{1}{2}$ " bit.

(For other attachments and accessories see pages 6, 10)

## SPECIFICATIONS

**CHUCK:** Jacobs key type,  $\frac{1}{8}$ " to  $\frac{1}{2}$ " capacity.

**BEARINGS:** 4 precision ball bearings mounted one above and one below the pulley, other two in quill.

**CAPACITY:** Chuck to table  $11\frac{1}{2}$ "; chuck to base 17"; center of chuck to column  $6\frac{1}{2}$ ", drills to center of 13" circle.

**TABLE:** New one piece type 9" x  $10\frac{1}{2}$ ", machined smooth.

**BASE:** Heavy casting with machined surface 9" x 8".

**COLUMN:** Seamless steel tubing

machined to close tolerances, 2" diameter.

**SPINDLE TRAVEL:**  $3\frac{1}{2}$ ", calibrated depth stop.

**SPINDLE:** 6 spline,  $\frac{5}{8}$ " diameter tapered at end for Jacobs chuck.

**HEAD:** Close-grained gray iron. Parts machined to close tolerances. Spindle cap gives extra protection to operator.

**SPEEDS:** 600, 1250, 2440, 5000 R.P.M.

**HEIGHT:** Overall 38".

**SHIPPING WEIGHT:** Without motor, 85 lbs.

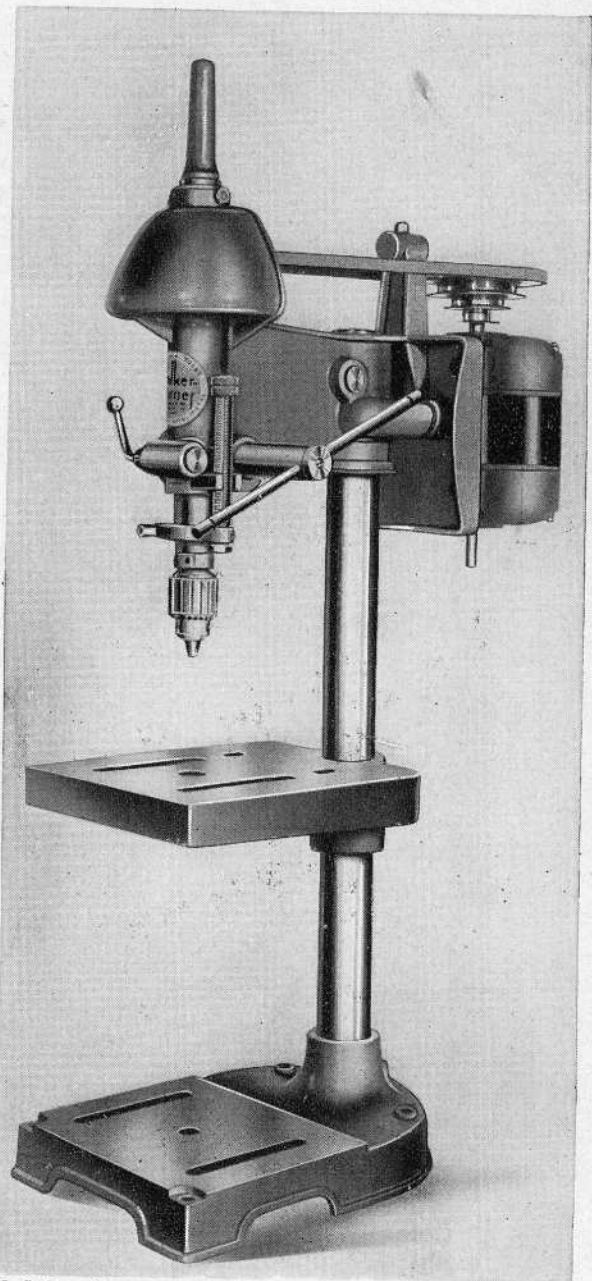

U. S. Pat. No. 2,072,646 Design Pat. No. 91,094

**D715**—Drill Press, as shown less motor; includes V-belt and motor pulley.

**9D17**—Idler Assembly.

**VB86-86"** Belt for Idler Drive.

**9D111**—New Motor Bracket (for attaching slow-speed attachment to older models).

**7D24**—Column collar.

Motor recommended,  $\frac{1}{8}$  H.P., 1740 R.P.M.

# WALKER-TURNER MACHINE TOOLS

DRILL  
PRESSES

# 16" METAL CUTTING BAND SAW

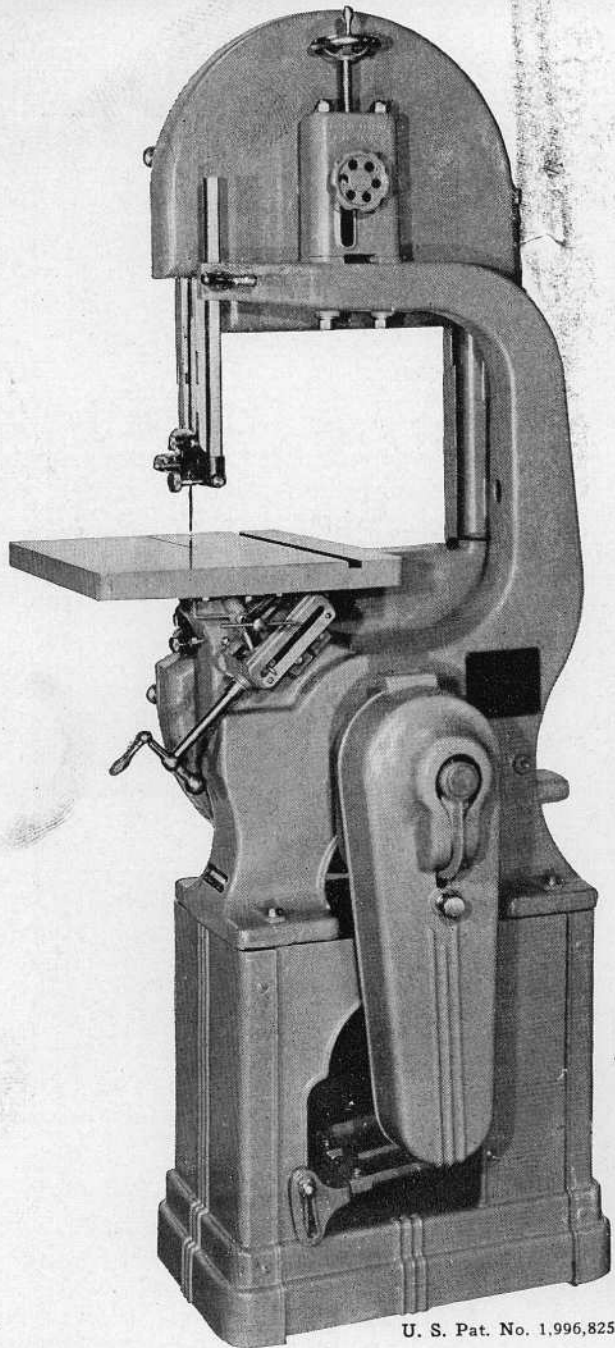

U. S. Pat. No. 1,996,825

**MBN1105**—16" metal cutting band saw, as shown, less motor, rip fence and base. Includes  $\frac{1}{2}$ " blade, new metal cutting guides, belt guard, belt and motor pulley.

**11BN45**—Special cast-iron base for GIB 5-7 motors.  
**KAB55**— $\frac{1}{2}$  H.P., 1740 R.P.M. motor, 110 volts, AC, 60 cycles.  
**GIB5**— $\frac{1}{2}$  H.P., 716 R.P.M. geared motor, single phase, 110-220 volts, AC, 60 cycles.  
**GIB7**— $\frac{3}{4}$  H.P., 716 R.P.M., 3 phase, 220 volts, AC, 60 cycles motor.

All wheel bearings are heavy duty precision ball bearings. Tables are heavily ribbed and carefully machined, tilt to  $45^\circ$  and have mitre gauge grooves.

Wheels are carefully balanced and rubber faced.

Blade guides have ball bearing thrust wheels and adjustable steel-faced guide pins designed especially for metal cutting.

Blade tensioning devices have spring cushions to absorb shocks.

Guard construction assures complete protection to operator.

Back gear unit provides wide range of slow speeds.

Heavy cast-iron, one piece frames have extra strength and rigidity.

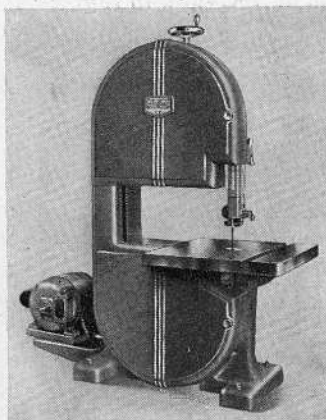

(Above) Rear Motor Mounting

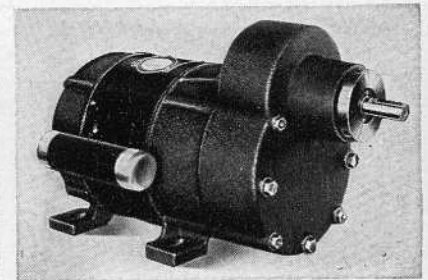

**SLO-SPEED MOTOR**—A new 716 R.P.M. back geared motor provides the extremely slow speeds necessary in cutting certain types of steel. Used on these metal cutting machines many speeds are available.

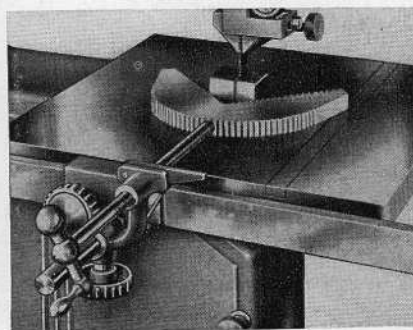

**SCREW FEED**—The screw feed with guiding segment, shown above left, greatly simplifies metal cutting. This attachment clamps to the table guide bar with the screw directly in line with the saw blade. The segment is not attached to table or screw. It holds square, hexagonal, triangular or round work in line without clamping while the screw advances it into the blade.

**9BN125**—Including guide bar.

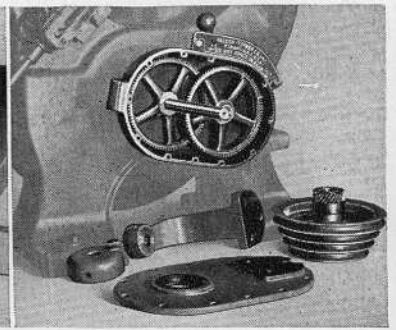

**BACK-GEAR UNIT**—This photo shows how substantially this unit is built. It is designed for long-run, trouble-free service on steady production work. Back-gearing and cone pulley—similar to those found on a screw-cutting lathe—provide eight speeds suitable for cutting practically every material from tool steel to wood. The gear train can be disengaged and the machine operated on direct drive for higher speed operations.

(For information on Other Band Saws see pages 34, 35, 36)

BAND  
SAWS

## WALKER-TURNER MACHINE TOOLS

# 14" METAL CUTTING BAND SAW

Every tool room, experimental department, general machine shop and metal-working plant has an opportunity to save money with these new back-gearred band saws. They cut sheets, rods and tubes of steel, iron, aluminum, brass, alloys and compositions quickly, accurately and economically. Molded plastics such as bakelite and catalin are also cut or trimmed efficiently on these metal cutting band saws.

In many shops these machines will pay for themselves on the first job. Their low initial cost and high operating efficiency combine to make them indispensable tools . . . money-makers from the start.

The geared speed reducer is a precision unit designed by engineers who know what is required of such a unit. A glance at the photos on the opposite page will show you that it is correctly and substantially designed for long-run, trouble-free service on steady production work. A feature that adds still greater value is the fact that the metal cutting machine may be speeded up for woodworking. By simply throwing the lever which disengages the gear train and engaging a pin it is immediately converted into a direct-drive machine with correct speeds for woodworking.

## SPECIFICATIONS

**WHEELS:** Gray iron carefully machined and balanced, rubber faced.

**BALL BEARINGS:** Large dust-sealed, precision in both wheels.

**GUIDES:** Are both ball-bearing with steel insert blocks for metal cutting.

**WHEEL GUARDS:** Are cast-iron hinged for convenience . . . telescoping guards at area of operation.

**ADJUSTING MECHANISM:** Blade and upper wheel mounted on two heavy ground steel rods . . . Cushion springs

absorb blade shocks.

**MOTOR BRACKET:** At rear of frame supplied with 16" model. For 14" model available as an extra.

**BLADE SPEEDS:** Standard motor, 16" model, 200, 300, 400, 560, 2000, 3000, 4150, 5300 F.P.M. 14" model, 175, 260, 350, 490, 1750, 2625, 3630, 4630 F.P.M. Slo-speed motor, 16" model, 70, 106, 151, 208, 746, 1129, 1607, 2216 F.P.M. 14" model, 61, 93, 132, 182, 653, 1103, 1413, 1950 F.P.M.

	16" Model	14" Model
Capacity, blade to frame . . . . .	16"	14"
Capacity, guide to table . . . . .	12"	7"
Table size . . . . .	18" x 17"	16" x 16"
Blade speeds, ft. per min., standard motor . . . . .	200-5300	175-4630
Blade speeds, ft. per min., slow-speed motor . . . . .	70-2216	61-1950
Height overall, without base . . . . .	50½"	44"
Height overall, with base . . . . .	71½"	65"
Width . . . . .	30½"	25¾"
Distance front to back . . . . .	22"	20"
Shipping weight, without base or motor . . . . .	455 lbs.	350 lbs.
Shipping weight, with base, less motor . . . . .	575 lbs.	470 lbs.

BLADES FOR 16" BAND SAW			
CAT. NO.	WIDTH	LENGTH	TEETH PER IN.
11BN90	½"	114¾"	10
11BN91	½"	114¾"	14
11BN92	½"	114¾"	18

BLADES FOR 14" BAND SAW			
CAT. NO.	WIDTH	LENGTH	TEETH PER IN.
9BN55	½"	96⅝"	10
9BN56	½"	96⅝"	14
9BN57	½"	96⅝"	18

Above blades for mild steel and non-ferrous metals.

A chart of blades recommended for various materials upon request.

(For information on Other Band Saws see pages 34, 35, 36)

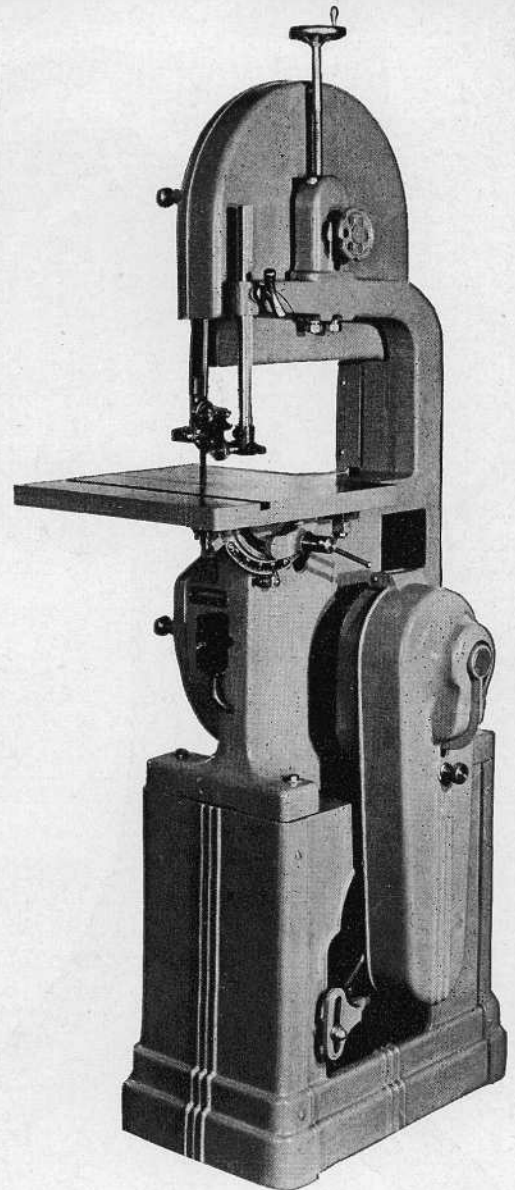

MBN935—14" metal cutting band saw, as shown above with new metal cutting guides including belt, motor pulley and guard; less base and motor.

9BN5—Motor bracket for rear mounting (not needed with 11BN4S).

11BN45—Special cast-iron base for GIB 5-7 motors.

EL5—Flexo lamp also fits 16" models.

See page 12 for motors.

# WALKER-TURNER MACHINE TOOLS

**BAND  
SAWS**

# FLEXIBLE SHAFT MACHINES

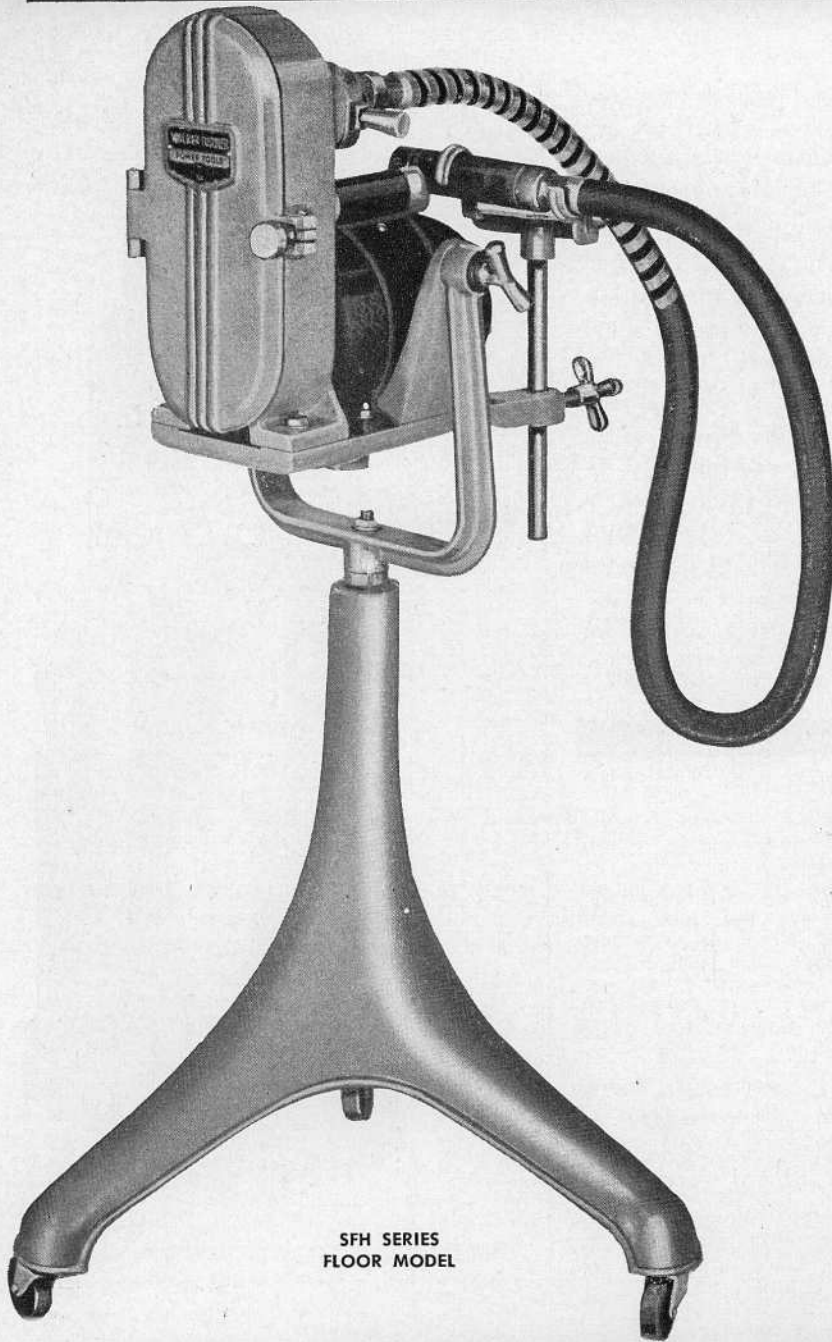

SFH SERIES  
FLOOR MODEL

**ALL REQUIREMENTS** for general purpose grinding, polishing, filing, buffing and similar work are answered by the SFH Series Floor Model and SFL Bench Model Flexible Shaft Machines shown on this and the following page.

**THREE TYPES OF SHAFTS** for (1) heavy duty, (2) medium duty, and (3) light duty, are available. Thus, through the acquisition of one machine and two additional shafts, as listed separately, an infinite variety of jobs can be handled by the same machine.

**INTERCHANGEABLE AT WILL** the three shafts can be switched in a few seconds. No tools are required to make the changeover.

**A WIDER RANGE OF SPEEDS**, in addition to those provided by 4-step V-pulleys can be obtained when using the medium duty shaft by interchanging the motor pulley and shaft drive pulley. This is not recommended when using the heavy and light shafts, due to the high speeds obtained.

**FLOOR MODELS** (SFH Series) are carried on a 3-leg pedestal base with ball bearing casters. Motors are hung in a yoke.

**BENCH MODELS** (SFL Series) do not have the yoke mounting. The ball bearing casters may be removed and the machine permanently mounted on the bench.

## CORES AND CASINGS

SF87 HEAVY DUTY CORE—7/16" diameter; 60" long.  
 WS117 CORE—5/16" diameter; 55 3/8" long.  
 WS117S CORE—1/4" diameter; 55 3/8" long.  
 SF91A CASING—  
 WSF116 CASING—4-wire; 53 1/2" long.

## SPECIFICATIONS

SFH1 — HEAVY DUTY FLOOR MODEL FLEXIBLE SHAFT MACHINE (without motor)

KEB7X—3/4 H.P. 3450 RPM MOTOR.

(Speeds—1270—1825—2500—3500 RPM)

Core — SF87 7/16" diameter — 60" long;  
 Casing—SF91A; Handpiece—SF56.

SFH2 — MEDIUM DUTY FLOOR MODEL FLEXIBLE SHAFT MACHINE (without motor)

KEB5X—1/2 H.P. 3450 RPM MOTOR.

(Speeds—3450—4500—6500—9500) or  
 (1275—1825—2500—3500)

Core—WSF117 5/16" dia. 55 3/8" long; Casing—  
 WSF116—4 wire Casing 53 1/2" long; Handpiece—  
 WAC4.

SFH3 — LIGHT DUTY FLOOR MODEL FLEXIBLE SHAFT MACHINE (without motor)

KEB5X—1/2 H.P. 3450 RPM MOTOR.

(Speeds—3450—4500—6500—9500)

Core—WSF117S 1/4" dia. 55 3/8" long. Casing—  
 WSF116 4-wire Case 53 1/2" long. Handpiece—  
 WAC4.

FLEXIBLE  
SHAFT  
MACHINES

# WALKER-TURNER MACHINE TOOLS

# FLEXIBLE SHAFT MACHINES

**OUTSTANDING FEATURES** of both Floor and Bench Models (many of which are exclusive) are:

Fully enclosed belt and pulley assembly.

Full length phosphor bronze bearing liner which minimizes vibration and adds greatly to life of the shaft.

Jackshaft spindle rotates on fully enclosed ball bearings.

Handpiece ball bearings are especially selected, and are protected at both ends from grit or dirt by scientifically designed labyrinth seals.

Motors are Walker-Turner "Custom Built"—among the finest obtainable regardless of price.

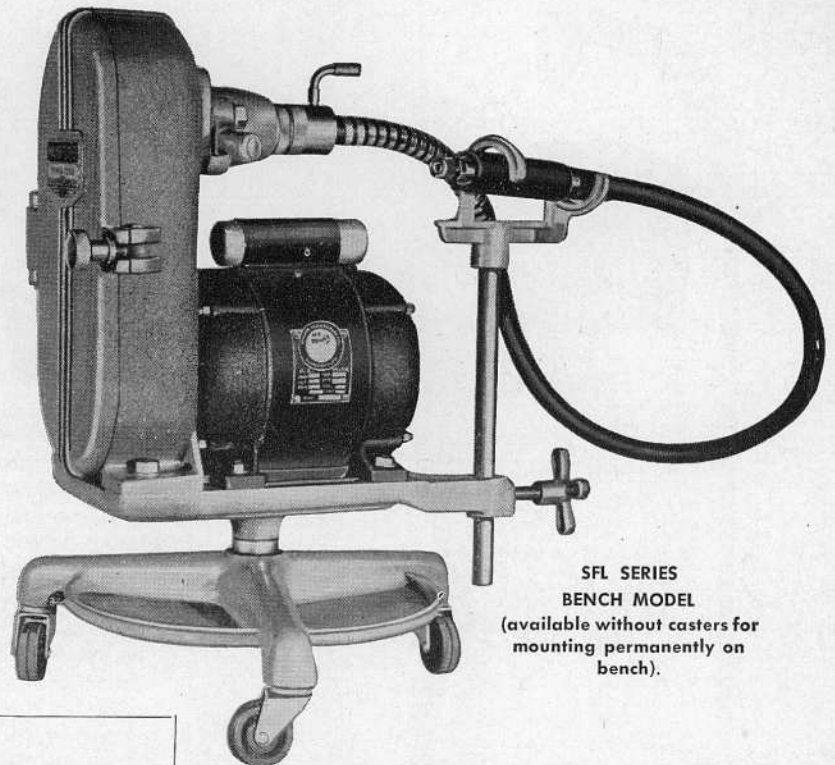

**SFL SERIES  
BENCH MODEL**  
(available without casters for mounting permanently on bench).

## HAND PIECES

The hand pieces supplied with Walker-Turner shafts are the result of several years of intensive study and development. Only especially selected bearings are used—these being protected on both ends of the hand piece by scientifically designed labyrinth seals which definitely prevent the entrance of grit or dirt and insure long, trouble-free service. A molded layer of synthetic rubber provides an ideal grip on the WAC4 hand piece.

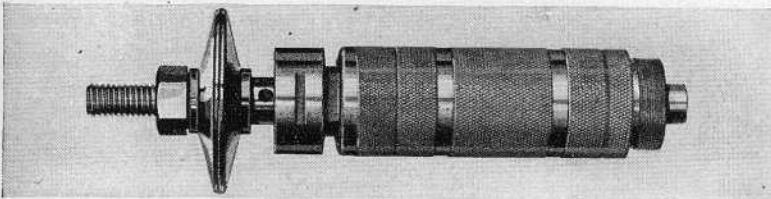

**SF56 HEAVY DUTY HAND PIECE.**  
Provided with a taper spindle and set of flange washers for grinding wheels, one collet chuck and one threaded adapter for sanding discs.

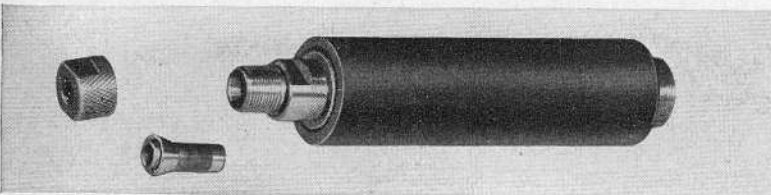

**WAC4 HAND PIECE**  
Designed especially for high speed work. It is provided with 1/4" draw-in collet and especially selected ball bearings for high speed work.

## SPECIFICATIONS

**SFL1—HEAVY DUTY BENCH MODEL MACHINE.** (without motor)

**KEB7X 3/4 H.P. 3450 RPM MOTOR.**  
(Speeds—1270—1825—2500—3500)

**SF87 Core 7/16" dia. 60" long; SF91A Casing; SF56 Heavy Duty Handpiece.**

**SFL2—MEDIUM DUTY BENCH MODEL MACHINE.** (without motor)

**KEB5X 1/2 H.P. 3450 RPM MOTOR.**  
(Speeds—3450—4500—6500—9500) or  
(1270—1825—2500—3500)

**WSF117 5/16" Core—55 3/8" long; WSF116 Casing 4-wire—53 1/2" long—rubber covered; WAC4 Handpiece with 1/4" draw-in collet chuck.**

**SFL3—LIGHT DUTY BENCH MODEL MACHINE.** (without motor)

**KEB5X 1/2 H.P. 3450 RPM MOTOR.**  
(Speeds—3450—4500—6500—9500)

**WSF117S 1/4" Core 55 3/8" long; WSF116 Casing—4-wire—rubber covered—53 1/2" long; WAC4 Handpiece.**

# WALKER-TURNER MACHINE TOOLS

**FLEXIBLE  
SHAFT  
MACHINES**

# FLEXIBLE SHAFT MACHINES

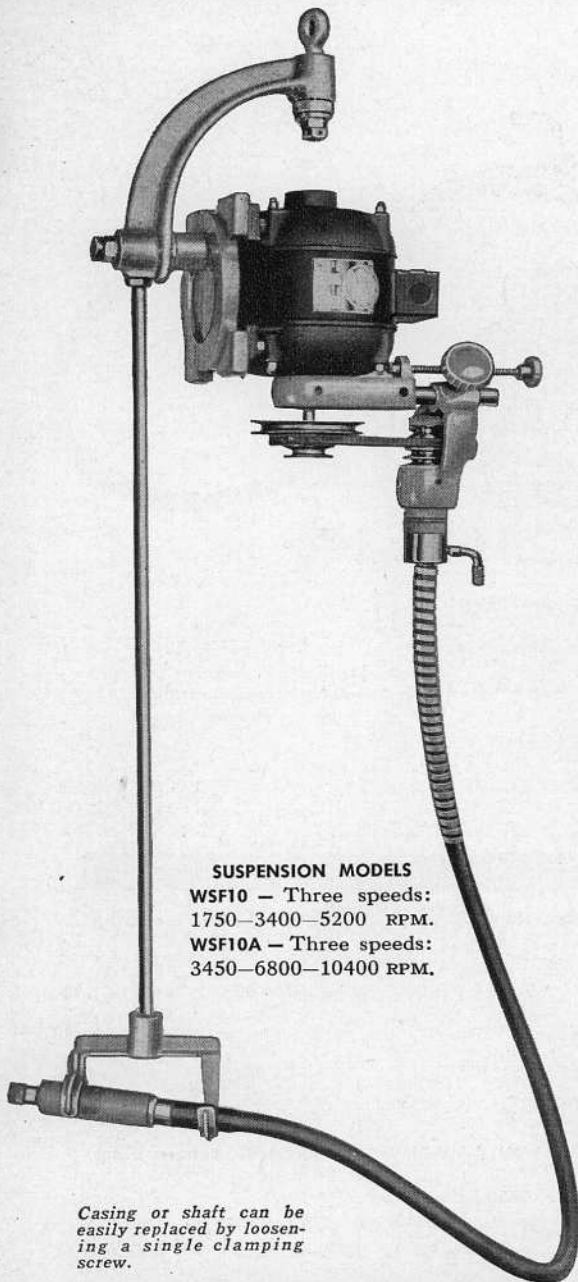

**SUSPENSION MODELS**  
**WSF10** — Three speeds:  
 1750-3400-5200 RPM.  
**WSF10A** — Three speeds:  
 3450-6800-10400 RPM.

Casing or shaft can be easily replaced by loosening a single clamping screw.

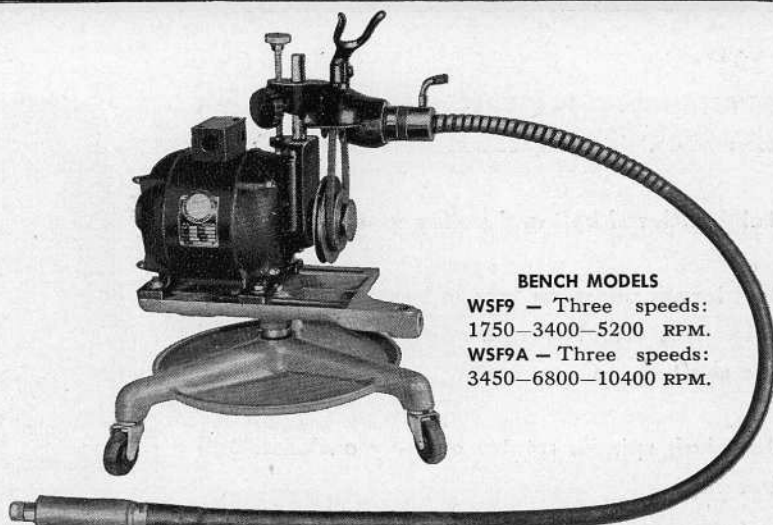
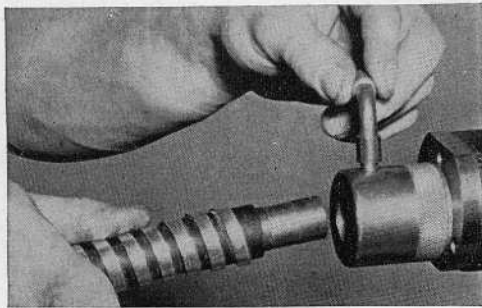

**BENCH MODELS**  
**WSF9** — Three speeds:  
 1750-3400-5200 RPM.  
**WSF9A** — Three speeds:  
 3450-6800-10400 RPM.

These compact flexible shaft units are fast becoming standard equipment among airplane engine manufacturers for high speed burring, grinding, and polishing of special parts such as crankshafts, connecting rods, pistons, etc.

Used extensively in defense industries where they are called on for continuous 24-hour service, these machines are not only designed with an ample factor of safety, but so that replacements when necessary can be made with a minimum loss of time and expense.

Parts are extremely simple and rugged. The jack-shaft unit is mounted directly on the extension on the motor bearing housing. The motor is of a semi-enclosed type and equipped with ball bearings. All ball bearings are carefully sealed and packed with a sufficient lubrication for several months of continuous operation. Replacement of casing or shaft can be made without tools and by merely loosening a single clamping screw. (See illustration below, left.)

The handpiece, WAC4, described on previous page, is equipped with ball bearings selected for their smooth, cool operation at high speed. Bearings are protected from grit by scientifically designed labyrinth seals on either end of the hand piece. A cover of synthetic rubber makes an ideal grip. The spindle is made of special alloy heat treated steel and is provided with a sliding collet chuck for accessories having  $\frac{1}{4}$ " shanks.

## SPECIFICATIONS

**WSF9—MEDIUM DUTY BENCH MODEL.**  
 (without motor)

**WKAB5— $\frac{1}{2}$  H.P. SINGLE PHASE, 1750 RPM**  
**110-220 VOLT 60 CYCLE MOTOR.**  
 (Speeds—1750-3400-5200 RPM)

**WSF117 Shaft— $\frac{5}{16}$ " dia.— $55\frac{3}{8}$ " long.**  
**WSF116 Case—4-wire—rubber covered; WAC4**  
**Handpiece—with  $\frac{1}{4}$ " draw-in collet. Base—**  
**Bench mounting with ball bearing casters—**  
**swivels 360°.**

**WSF9A—HIGH SPEED BENCH MODEL.**  
 (without motor)

**WKEB5— $\frac{1}{2}$  H.P. SINGLE PHASE, 3450 RPM**  
**110-220 VOLT 60 CYCLE MOTOR.**  
 (Speeds—3450-6800-10400 RPM)

**WSF117S  $\frac{1}{4}$ " dia. Shaft— $55\frac{3}{8}$ " long. WSF116**  
**Casing—rubber covered. WAC4 Handpiece—**  
**with  $\frac{1}{4}$ " draw-in collet. Base—Bench**  
**mountings with ball bearing casters—**  
**swivels 360°.**

**WSF10—MEDIUM DUTY SUSPENSION MODEL**  
 (without motor)

**WKAB5— $\frac{1}{2}$  H.P. SINGLE PHASE, 1750 RPM**  
**110-220 VOLT 60 CYCLE MOTOR.**  
 (Speeds—1750-3400-5200 RPM)

**WSF117 Core,  $\frac{5}{16}$ " dia.— $55\frac{3}{8}$ " long;**  
**WSF116 Case—4-wire—rubber covered; WAC4**  
**Handpiece—with  $\frac{1}{4}$ " collet chuck; SF10 Sus-**  
**pension Mounting.**

**WSF10A—HIGH SPEED SUSPENSION MODEL**  
 (without motor)

**WKEB5— $\frac{1}{2}$  H.P. SINGLE PHASE, 3450 RPM**  
**110-220 VOLT 60 CYCLE MOTOR.**  
 (Speeds—3450-6800-10400 RPM)

**WSF117S  $\frac{1}{4}$ " dia. Core —  $55\frac{3}{8}$ " long; WSF116**  
**Casing—rubber covered; WAC4 Handpiece—**  
**with  $\frac{1}{4}$ " draw-in collet chuck; SF10 Suspen-**  
**sion Mounting.**

**FLEXIBLE  
 SHAFT  
 MACHINES**

# WALKER-TURNER MACHINE TOOLS



# FLEXIBLE SHAFT MACHINES

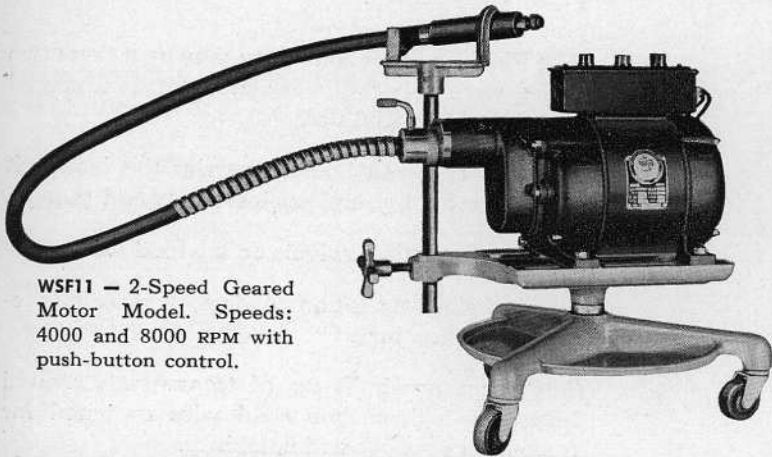

**WSF11 — 2-Speed Geared Motor Model.** Speeds: 4000 and 8000 RPM with push-button control.

**WSF11 2-SPEED GEARED MOTOR MODEL**—In this model pulleys and belts have been eliminated by the use of the Walker-Turner 2-speed geared motor. A conveniently located interlocking switch makes two speeds immediately available: a low of 4000 RPM and a high of 8000 RPM. The motor and gears are quiet and efficient in operation. Two speed motors are available in 2 or 3 phase current *only*.

**WSF12 SINGLE SPEED SUSPENSION MODEL**—This machine is particularly adapted for use in foundries and machine shops for general purpose grinding and filing. The use of the full length bronze bearing liner on the shaft practically eliminates the vibration so common to suspended model flexible shaft machines. A collet chuck for rotary files as well as knock-out spindles for grinding and buffing wheels are available for use with the handpiece SF56.

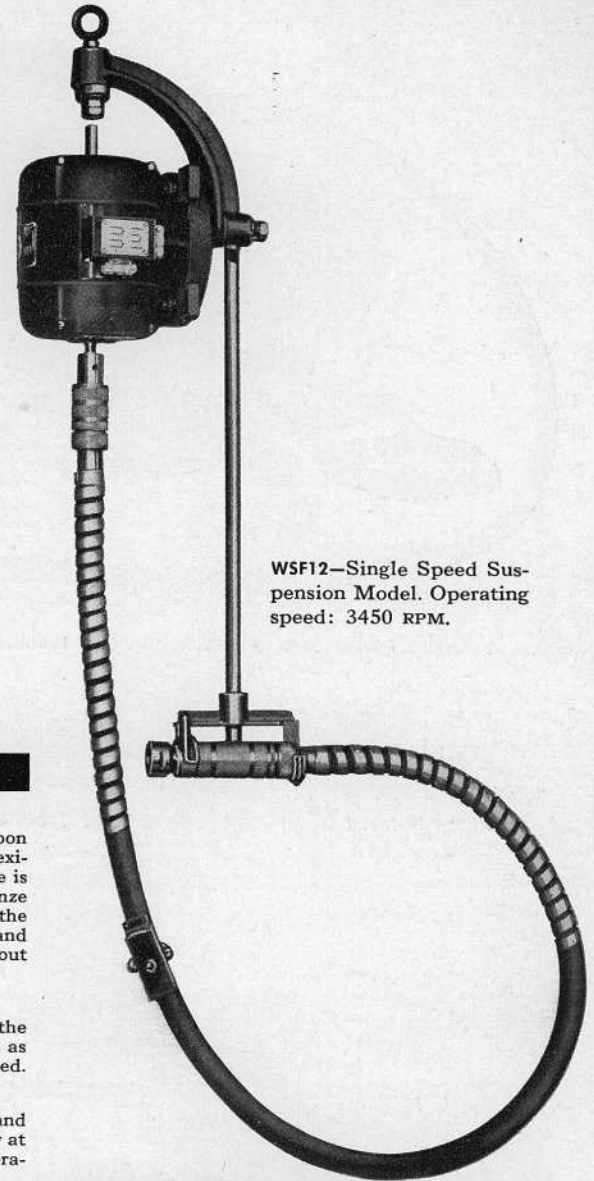

**WSF12—Single Speed Suspension Model.** Operating speed: 3450 RPM.

## CASINGS AND CORES

### SF91A CASING

The casing used on the heavier shafts is rugged enough to stand the hardest service, yet extremely flexible and not too bulky for convenience. It is of all-metal construction except for an outside layer of rubber. Built of an inner layer of tempered steel covered over with a second layer of mild steel, the shaft is prevented from stretching by a braided layer of phosphor bronze wire. Over the phosphor bronze is a heavy layer of rubber.

### WSF116 CASING

For the lighter shafts. Is of the same general construction as No. SF19A above, except for the layer of phosphor bronze wire which is eliminated for maximum flexibility.

### SF87—7/16" x 60" CORE.

Built up of alternate layers of high carbon music wire wound for maximum strength, flexibility and long life. Over the completed core is a specially wound layer of phosphor bronze which minimizes vibration by filling in the space between the core and the casing and affords an ideal bearing for the shaft throughout its entire length.

### WSF117—5/16" x 55 3/8" CORE.

Is of the same general construction as SF87; the bronze bearing liner is of still greater value as it minimizes vibration and wear at high speed.

### WSF117S—1/4" x 55 3/8" CORE

Of the same general construction as SF87 and WSF117; the shaft will operate continuously at 10,000 revolutions with a minimum of vibration and wear.

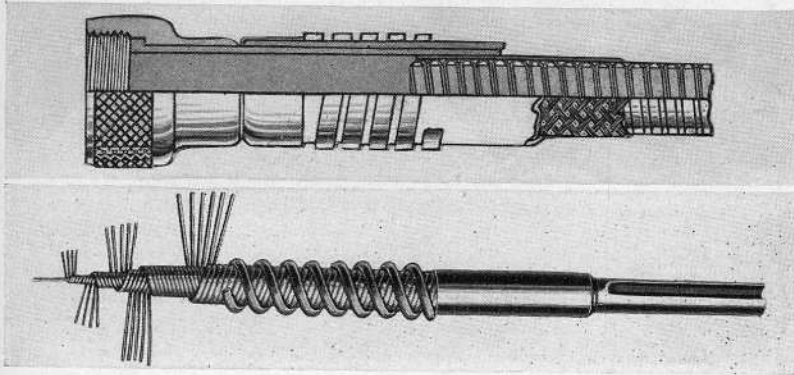

## SPECIFICATIONS

**WSF11—TWO-SPEED GEARED MOTOR FLEXIBLE SHAFT MACHINE**  
SPEC GB7T Motor with two-speed winding and switch; WSF116 4-wire rubber covered Casing 53 1/2" long; WSF117 5/16" core with phosphor bronze bearing liner—55 3/8" long; WAC4 Handpiece with 1/4" draw-in collet chuck; SF52 Swivel Base. (Supplied *only* with 5/16" core.)

**WSF12—SINGLE SPEED SUSPENSION MODEL FLEXIBLE SHAFT MACHINE** (For operating speeds of 3450 RPM)

Consists of Hanging bracket (SF10) with handpiece rest bracket; SF87 7/16" dia. 60" length core with phosphor bronze bearing liner; SF91A Case; SF56 Heavy Duty Handpiece; SF55 1/2" Motor Coupling; Motor recommended either KEB5 or KEB7—1/2 H.P. or 3/4 H.P. 3450 RPM Motor.

Complete motor data, page 54.

# WALKER-TURNER MACHINE TOOLS

**FLEXIBLE  
SHAFT  
MACHINES**

# FLEXIBLE SHAFT MACHINES



258—MULTI-SPEED PORTABLE FLEXIBLE SHAFT MACHINE (without motor)

Consists of:

SF52 Base; SF52A Pulley housing, ball bearing jackshafts, pulleys and belt; SF551 Case, 60" long; SF552 Core, 60" long; SF506 Ball bearing handpiece. (Speeds—1400—2600—4600—8400 RPM with KEB5X ½ H.P. 3450 RPM AC 110-220 V. 60 CYCLE MOTOR)

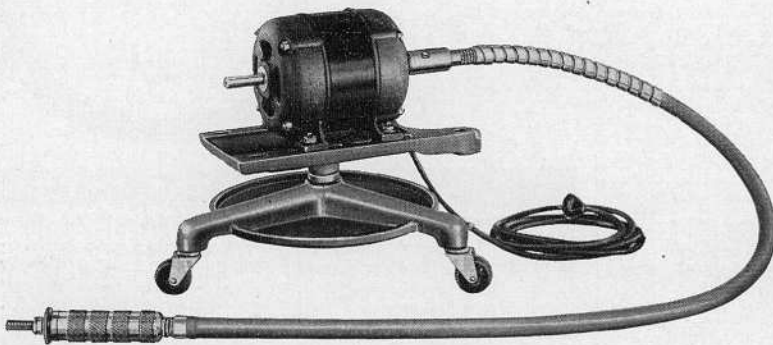

253—DIRECT DRIVE PORTABLE FLEXIBLE SHAFT MACHINE

Consists of:

SF52 Base; SF506 Ball bearing handpiece; SF551 Case, 60" long; SF552 Core, 60" long; SF57 Coupling; (Uses KEB5X ½ HP 3450 RPM Motor).

The Flexible Shaft Machines shown on these two pages were especially designed for commercial and light industrial use.

A heavy cast-iron housing carries the jackshaft bearing assembly and encloses belt and pulleys.

The upper section swivels on a tripod base.

The jackshaft turns on two large, dust-sealed precision ball bearings.

The cores are built up of transversely wound layers of high carbon steel wire designed for maximum strength and flexibility.

The casings of 256, 257, and 5340 are 43" long, made of interlocking layers of steel. Inner layer is carbon steel oil tempered. Protected against grease leakage. The handpiece is ball-bearing, cup-and-cone type, intended for semi-industrial use.

Four speeds cover all normal requirements.

## 251—SHAFT ASSEMBLY

This assembly is comprised of a 3/8" diameter core built up of transversely wound layers of high carbon steel wire for maximum strength and flexibility; and a casing made of high carbon spring steel wire wound in combination with dead-soft filler wires. This type construction gives extreme flexibility yet keeps the casing oil-tight. A rubber covering gives further protection and prevents the entrance of foreign matter. Ball bearing handpiece and motor coupling. Fits any 1/2" shaft.

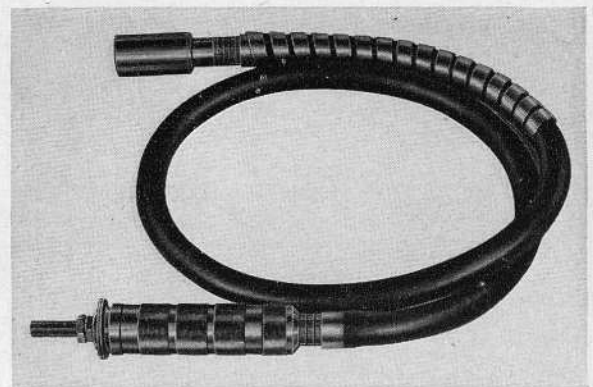

251 SHAFT ASSEMBLY as shown

Consists of:

SF506 HANDPIECE ONLY

SF552 CORE ONLY for 251, 253, 258

SF551 CASING

SF57 MOTOR COUPLING ONLY

FLEXIBLE  
SHAFT  
MACHINES

# WALKER-TURNER MACHINE TOOLS

# FLEXIBLE SHAFT MACHINES

For continuous industrial or commercial production work the heavier industrial models shown on the foregoing pages are recommended.

**MODELS 258 AND 253** are identical with the exception of the drive; one is direct connected to the motor, the other a belt drive multi-speed model. Especially adapted for repair, service and maintenance shops of all types for grinding, sanding, drilling, buffing and similar operations.

**MODELS 256 AND 257** are the same except that 256 has a wide selection of speeds while 257 operates at motor speeds only. Although these shafts are not as heavy as those shown on previous pages many thousands are in use on light and medium duty work in industrial and commercial plants, and in workshops. Their fine record of performance has been established for many years. We believe them to be the best available at their prices and superior to many other shafts selling at higher prices.

## 5340—SHAFT ASSEMBLY

This assembly, comprising a 5/16" diameter core, casing, ball bearing motor coupling, adapter and cup-and-cone-type ball bearing handpiece is ready to attach to any motor shaft of 1/2" diameter turning at not less than 1740 RPM. The adapter with flanges is 1/2" in diameter. Same core, casing, handpiece and adapter as used in outfit number 256. Length of assembly, 49 1/2".

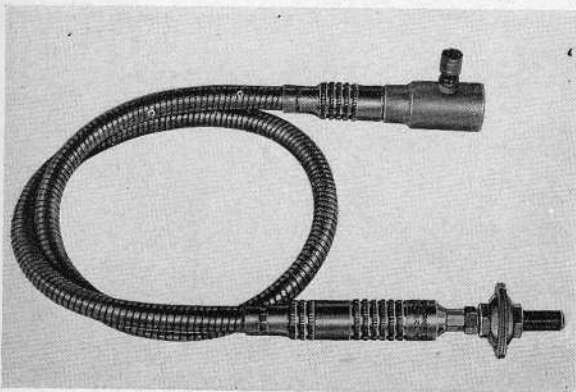

**5340 SHAFT ASSEMBLY** as shown  
Consists of:  
BBF1 BALL BEARING HANDPIECE  
BBF2L 43 1/4" CASE  
BBF3L 43 3/8" CORE

BBF7 COUPLING  
939 1/4" DRILL CHUCK  
F5405 ADAPTER  
BBF5 GRIP FOR SHAFT

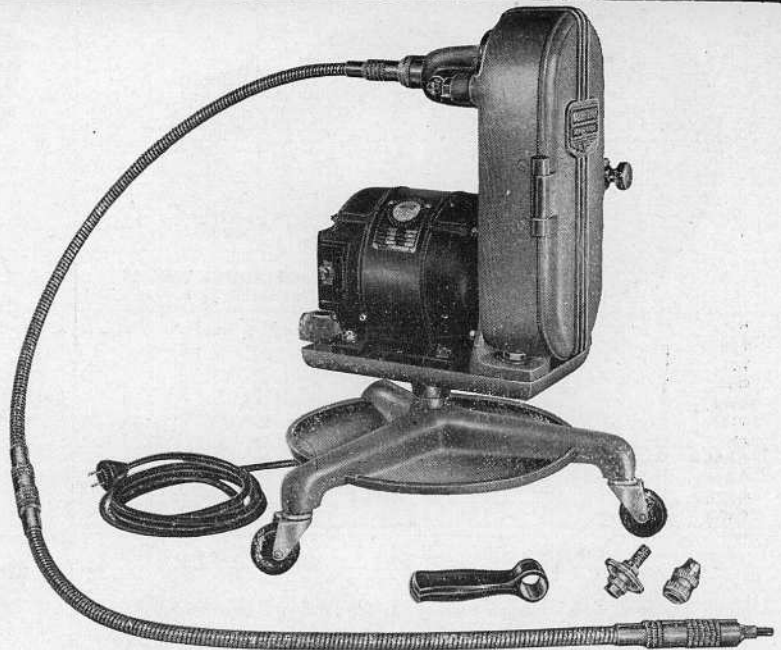

## 255—MULTI-SPEED PORTABLE FLEXIBLE SHAFT MACHINE (without motor)

Consists of:

SF52 Base; SF52A Pulley housing, ball bearing jackshafts, pulleys and belt; BBF1 Ball bearing handpiece; BBF2L Case, 43 1/4" long (two supplied); BBF3L Core, 43 3/8" long, (two supplied); BBF5 Grip for shaft; F5405 Adapter; No. 939 1/4" Drill chuck.

(Speeds—700—1340—2320—4200 RPM) with

SAB3X 1/3 H.P. 1740 RPM MOTOR.

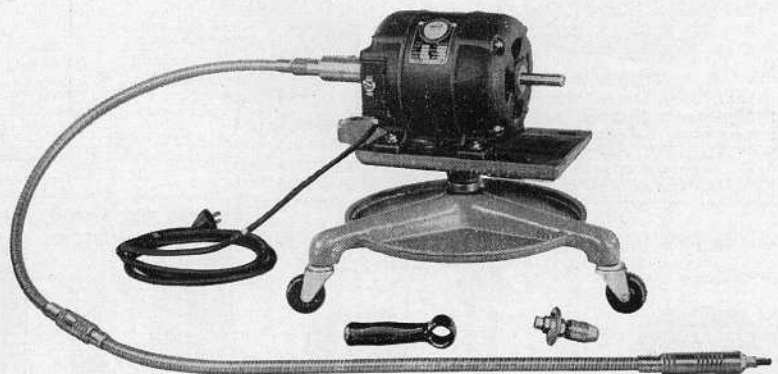

## 257—DIRECT DRIVE PORTABLE FLEXIBLE SHAFT MACHINE (without motor)

Consists of:

SF52 Base; BBF1 Ball bearing handpiece; BBF2L Case, 43 1/4" long (two supplied); BBF3L Core, 43 3/8" long (two supplied); BBF5 Grip for shaft; BBF7 Coupling; F5405 Adapter; No. 939 1/4" Drill chuck; (Uses SAB3X 1/3 H.P. 1740 RPM Motor.)

# WALKER-TURNER MACHINE TOOLS

FLEXIBLE  
SHAFT  
MACHINES

# FLEXIBLE SHAFT ACCESSORIES

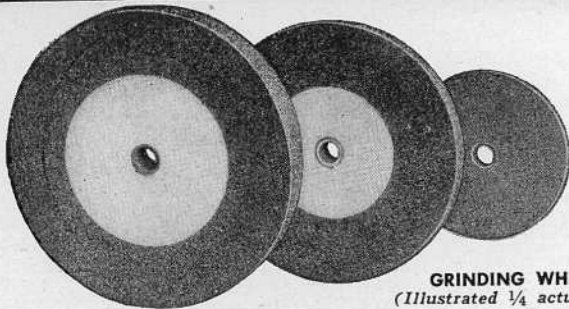

**GRINDING WHEELS**  
(Illustrated 1/4 actual size)

NO.	DIAM.	THICKNESS	GRIT	BORE	PRICE
930	4"	1/2"	Med.	1/2"	
943	4"	1"	Med.	1/2"	
G36	6"	1/2"	Coarse	1/2"	
G60	6"	1/2"	Fine	1/2"	
636	6"	3/4"	Coarse	1/2"	
660	6"	3/4"	Fine	1/2"	
GR58	7"	1"	Coarse	5/8"	
GR59	7"	1"	Fine	5/8"	
GR75	10"	1"	Coarse	3/4"	
GR76	10"	1"	Fine	3/4"	

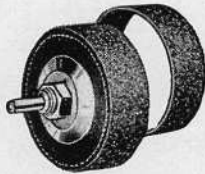

**SANDING SLEEVE DRUMS**  
(Illustration 1/4 actual size)

- DS30—3" x 1" Drum.
- DS30C—6 Coarse Sleeves.
- DS30F—6 Fine Sleeves.
- DS20—2-3/16" x 1" Drum.
- DS20C—6 Coarse Sleeves.
- DS20F—6 Fine Sleeves.
- DS15—1 1/2" x 1" Drum.
- DS15C—6 Coarse Sleeves.
- DS15F—6 Fine Sleeves.

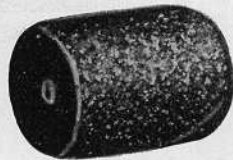

**SANDING DRUM**  
(Illustration 1/4 actual size)

- FS411—Sanding Drum, heavy molded rubber drum 3" long x 2 1/4" in diameter with 1/2" hole. Adapter supplied for 5/16" threaded spindles.
- FS412—Abrasive Sleeve only.

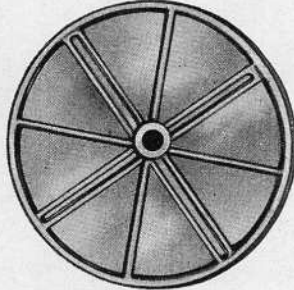

**SANDING DISC** (1/4 actual size)

- FS413—Sanding Disc metal face plate rubber cushion, and abrasive disc.
- FS418—Quick Setting Cement (not illustrated) for holding abrasive discs to face plate.

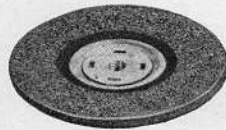

- SF2D 7" Flexible pad
- SF4 36 grit abrasive discs (6)
- SF6 60 grit abrasive discs (6)
- SF8 80 grit abrasive discs (6)

**6" WHEEL GUARD**

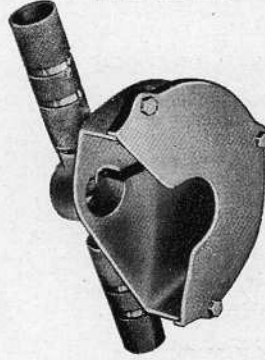

SF9H—Guard for SF56 Hand-piece.

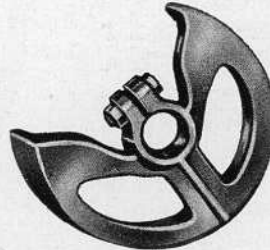

BBF6—Wheel Guard for 4" Diameter wheels. (For BBF Series Flexible Shaft Machines only.)



BBF5 — Hand Grip for BBF Series Flexible Shaft Machines only.



**WIRE CUP BRUSHES**

- 955—4" Wire Cup Brush—1/2" hole.
- 956—2 3/4" Wire Cup Brush—1/2" hole.



(Illustration 1/4 actual size)  
FS409—Wire Carbon Removing Brush (1 1/8" Dia.)

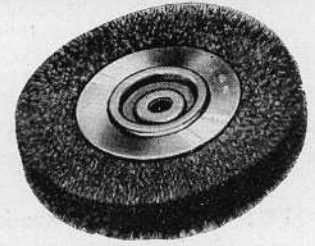

**WIRE WHEELS**

- 932—Coarse—4" with 1/2" hole.
- 932F—Fine—4" with 1/2" hole.
- 950—Coarse—6" with 1/2" hole.
- 951—Fine—6" with 1/2" hole.
- GR60—Coarse—7" with 5/8" hole.

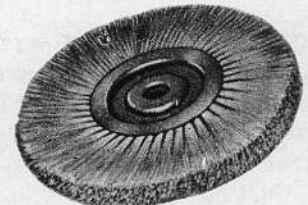

**TAMPICO BRUSH**

- 952—6" Brush—1/2" hole, steel hub.

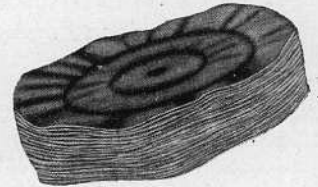

**BUFFERS**

- FS426—6" Cotton Buffer—1/2" hole.
- 931—3" Cotton Buffer—1/2" hole.



(Illustration 1/4 actual size)

**ANGLE HEADS**

- SF125—For SF91A Casing.
- SF125A—For SF83A Casing.
- 249—For Models 253, 256, 257, 258, and 5340.

## CUTTERS FOR WOOD, PLASTICS AND NON-METALIC MATERIALS

**CHUCKS**  
(Illustration 1/4 actual size)



- 33B—Jacobs Chuck —1/16" to 1/2" cap.
- DP110—Chuck—0" to 1/2" cap.



CR1



CR2



CR4



CR5



CR6



CR3

(Illustrations 1/2 size)

- CR1—Liner.
- CR2—Half Round.
- CR3—Round Nose.

- CR4—Hook Tool.
- CR5—Button Drill.
- CR6—Straight Face.

- CR7—Extension Shank for holding cutters.
- CR8—Saw.



CR8



CR9



CR10



CR11



CR12



CR13

- CR9—Round.
- CR10—Flame.
- CR11—Inverted Cone.

- CR12—Pointed.
- CR13—Cylindrical.
- CR20—Set of 6 Burrs with 1/8" shanks.

(Illustrations full size)

**FLEXIBLE  
SHAFT  
ACCESSORIES**

# WALKER-TURNER MACHINE TOOLS

# BELT and DISC SURFACER

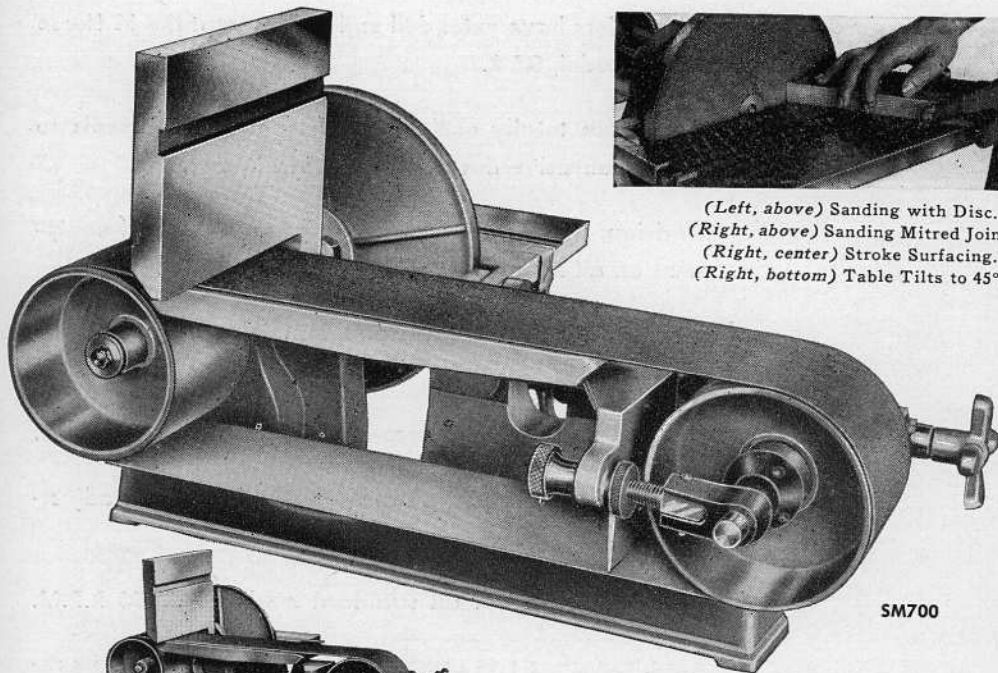

SM700

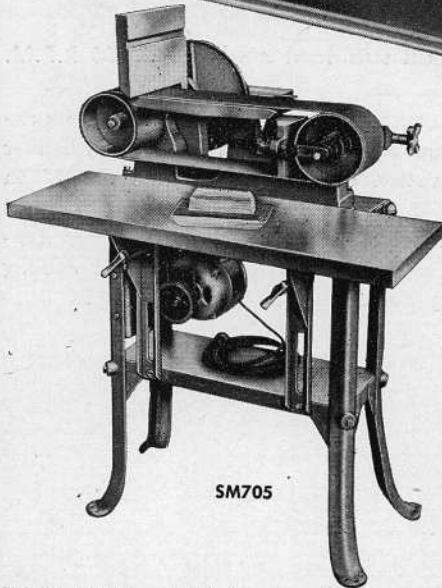

SM705

**FLOOR MODEL**—With the special all-steel stand it is possible to do "stroke surfacing" on large panels, up to 12" in width and 4' to 5' in length. The shelf is adjustable up and down for a distance of 14" permitting wood up to that thickness to be sanded.

**SM700**—Surfacer (as shown above) includes motor pulley, V belt, hand block and mitre gauge.

**SM705**—SM700 Surfacer complete with steel bench, adjustable shelf and motor bracket (less motor). (Motor recommended—for ordinary work  $\frac{1}{3}$  H.P. 1740 R.P.M. For heavy work  $\frac{1}{2}$  H.P. 1740 R.P.M.)

**24**—Bench only, for converting SM700 to SM705.

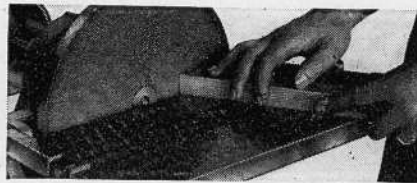

(Left, above) Sanding with Disc.  
(Right, above) Sanding Mitred Joint.  
(Right, center) Stroke Surfacing.  
(Right, bottom) Table Tilts to 45°.

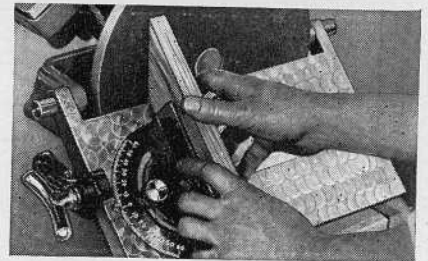
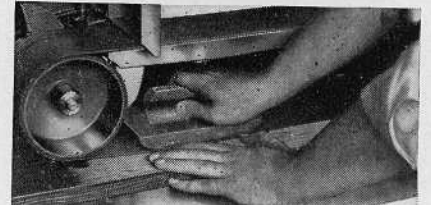
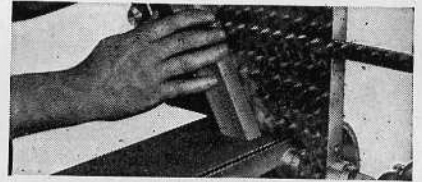

## SPECIFICATIONS

**BASE:** Heavy cast-iron, accurately machined for various parts. Has built-in drive belt and pulley guard.

**BEARINGS:** Completely dust-sealed, packed with grease at the factory and require no further attention or lubrication. Four bearings are used.

**PULLEYS:** Aluminum die castings 5" in diameter, accurately balanced. Drive pulley is rubber faced and slightly crowned.

**BELT:** Aluminous oxide, fabric backed. Available in three grades of grit, 36, 60 and 120. Regular equipment 60 grit. Belt 4" x 52 $\frac{1}{2}$ ". Tension varied by cushion spring control.

**SANDING DISC:** 10" diameter, cast-iron, carefully balanced.

**ABRASIVE:** Aluminous oxide, 40 grit. 60 and 80 grit abrasive discs also available.

**MACHINE SPEEDS:** 765, 1350 and 2275 R.P.M.

**ABRASIVE BELT SPEEDS:** 1050, 1760

and 3100 feet per minute.

**TILTING TABLE:** Hinged for disc. Cast-iron with smooth ground surface. 12" x 6", tilts from 90° to 45°, with angle of tilt indicated on graduated quadrant.

**MITRE GAUGE:** Furnished regular equipment.

**SANDING TABLE:** (Under the upper section of belt) cast-iron, carefully machined 12" x 4 $\frac{1}{4}$ ". Is attached to and adjusts on base. Carries a stop table 8 $\frac{1}{2}$ " x 6", which tilts 90° to 45° with indicator and graduated collar.

**PIVOTED BRACKET:** With knurled adjusting and lock nuts to control idler pulley alignment.

**DISTANCE:** Between centers of pulleys 18".

**LENGTH:** Overall 29".

**HEIGHT:** Overall 16".

**SHIPPING WEIGHT:** SM700 (98 lbs.), SM705 (143 lbs.).

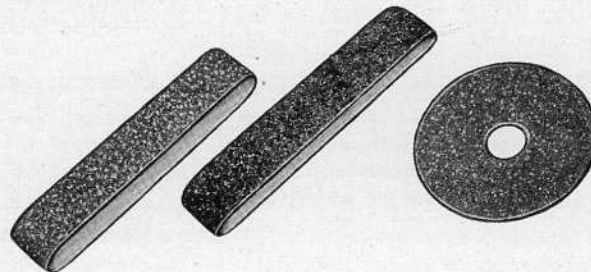

**ABRASIVE BELTS & DISCS**  
Aluminous oxide, fabric backed for SM700. Endless, 53" long.

**SM36B**—36 grit belt.

**SM60B**—60 grit belt.

**SM120B**—120 grit belt.

**SM40**—40 grit, pkg. of 6.

**SM60**—60 grit, pkg. of 6.

**SM80**—80 grit, pkg. of 6.

**L355**—Pkg. of 6 assorted discs for FS413.

# WALKER-TURNER MACHINE TOOLS

DISC  
SURFACER

# W-T MOTOR GRINDERS

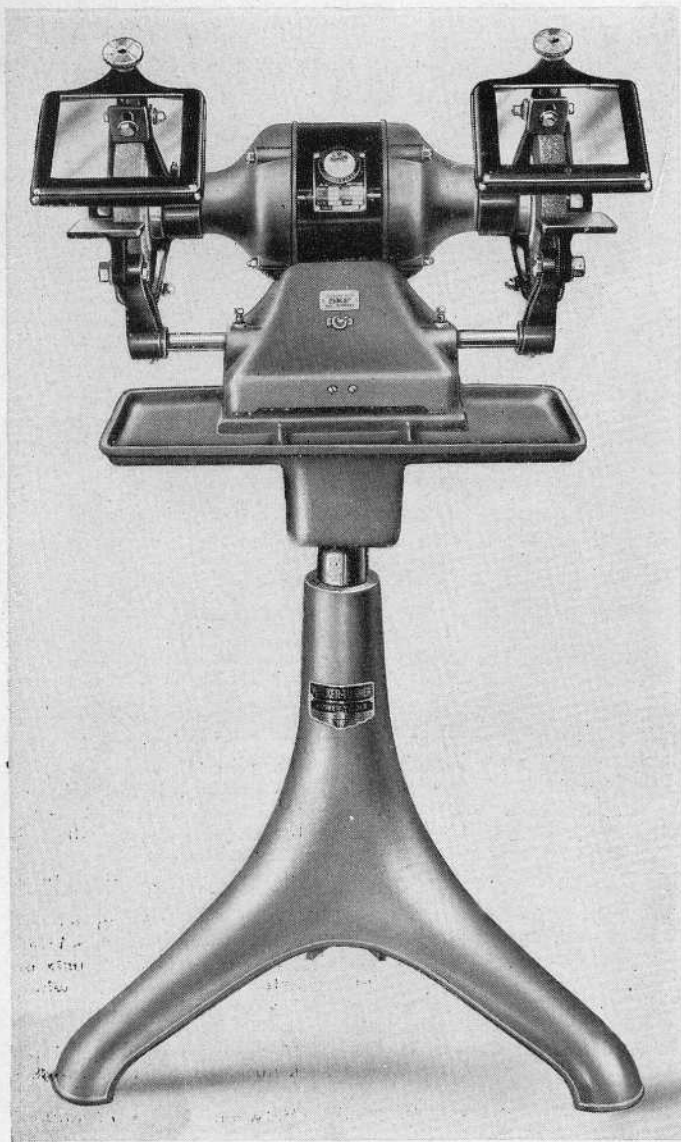

GR50— $\frac{1}{2}$  H.P. Grinder (110 volts, 60 cycle, A.C.) as shown above (without stand).

CG50—Combination Grinder and Disc Sander as shown at right. Odd voltage and cycles available at extra cost.

**GMP5—PEDESTAL STAND FOR ALL MODELS**—Table and tripod stand are of cast iron. Table is 18" x 14" with cooling cup located at front center. Tool tray provided on either side of cooling cup. Table top is drilled to take grinders shown on this page only. Ground steel column, 2" in dia., connects table with stand. Adjustable 12" up or down. Shipping weight 70 lbs.

220-230 volts extra. Available for 3 phase or direct current at extra cost.

All grinders have extended end bells except the  $\frac{1}{3}$  Horse Power model, GR-3.

Motors are totally enclosed with special shaft seals to prevent abrasive dust damaging vital parts.

Precision, dust sealed ball bearings are standard equipment on all models.

A ground wire is furnished on all models except the three phase.

The guards are easily removed for buffing operations.

All models fit the pedestal base, GMP5, which is adjustable for height.

Operating speed of all standard models is 3450 R.P.M.

**$\frac{1}{2}$  H.P. CAPACITOR TYPE GRINDER**—This grinder GR50 with its capacitor type motor and ample overload capacity will deliver years of steady, consistent service. The wheels are 7" in diameter, 1" wide,  $\frac{5}{8}$ " hole. Full protection guards designed according to latest safety code requirements; large, non-shatterable glass shields; adjustable tool rests and cooling cup. A highgrade snap switch is built into the base.

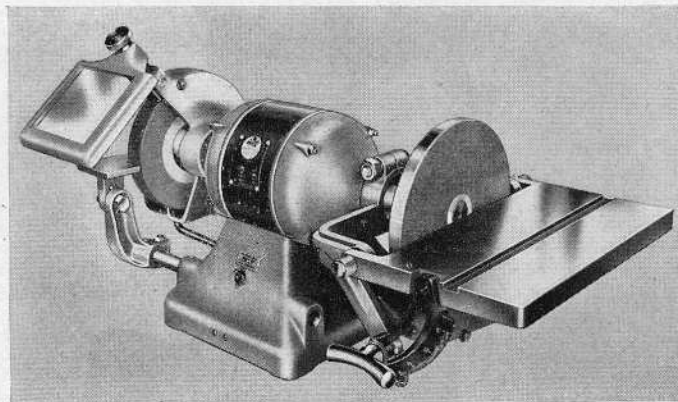

**COMBINATION GRINDER AND DISC SANDER**—This combination model CG50 has the same features as specified above for the GR50 except that the disc sander attachment is substituted for one wheel and guard. CG50 will prove an invaluable aid in any shop where there are small parts to be ground and surfaced . . . a workman can do several different operations on a single piece without leaving the machine.

**MOTOR  
GRINDERS**

**WALKER-TURNER MACHINE TOOLS**

# NEW 10" GRINDER

**THE MOTOR** is fully enclosed and specially designed seals prevent the entrance of dust into ball bearings. The motor end bells are extended, allowing the use of both sides of the grinding wheels.

**WHEEL GUARDS** are of heavy construction with removable covers affording ready access to the wheels.

**TOOL RESTS** are rigidly mounted on steel bars which extend from the base. Every necessary adjustment is readily available.

**TWO VITRIFIED WHEELS** (one fine grit, one coarse grit, both 10" diameter by 1" face x 3/4" bore) are supplied as standard equipment.

## Extra Equipment Available

**GR100-A EYE SHIELDS**, available as extra equipment, are of the approved type of shatter-proof glass. A light is built into the frame of the eye shield and so mounted as to illuminate the work without causing glare on the glass:

**No. GR101 BASE** or pedestal, available as extra equipment, is of heavy cast-iron. The top provides a convenient tray for tools or work, as well as a receptacle for holding cooling water.

(Note)—No. GR100 Grinders are available in three phase current only.

**SPEEDS:** 1725 RPM with 60 cycle motor;  
1500 RPM with 50 cycle motor.

## 1/3 H.P. GRINDER

**GR36**—This GR36 grinder has tool rests adjustable two ways, guards which have covers on the outside of the wheels, a sturdy 10 ampere switch located in the base. Wheels are 6" in diameter, 3/4" wide, 1/2" hole. A 10' cord and plug is supplied.

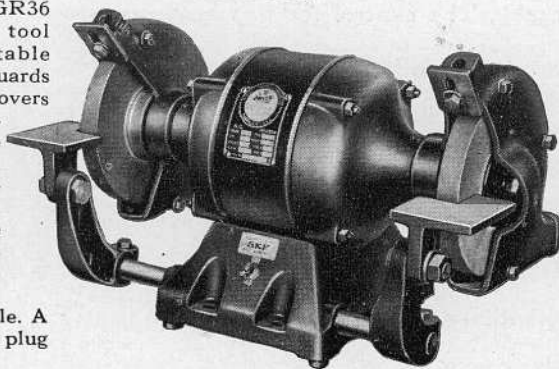

## 1/3 H.P. LIGHT DUTY GRINDER



**GR3**—Wheels are 6" in diameter, 1/2" wide, 1/2" hole. Tool rests are adjustable for wheel wear. On and off switch, cord and plug supplied.



**GR100**—1 H.P. Grinder, as shown, less eye shields and base.

**GR100A**—Shatterproof eye shields.

**GR101**—Cast-iron base.

**GR36**—1/3 H.P. Grinder (110 volts, 60 cycle, A.C.) as shown. Shipping weight 60 lbs.

**GR35**—1/3 H.P. Grinder (same as GR36 but including eye shields and cooling cup). Odd voltages and cycles available at extra cost.

**GR3**—1/3 H.P. Grinder (110 volts, 50-60 cycles, A.C.), as shown. Shipping weight approximately 50 lbs.

# WALKER-TURNER MACHINE TOOLS

**MOTOR  
GRINDERS**

# POLISHING LATHES

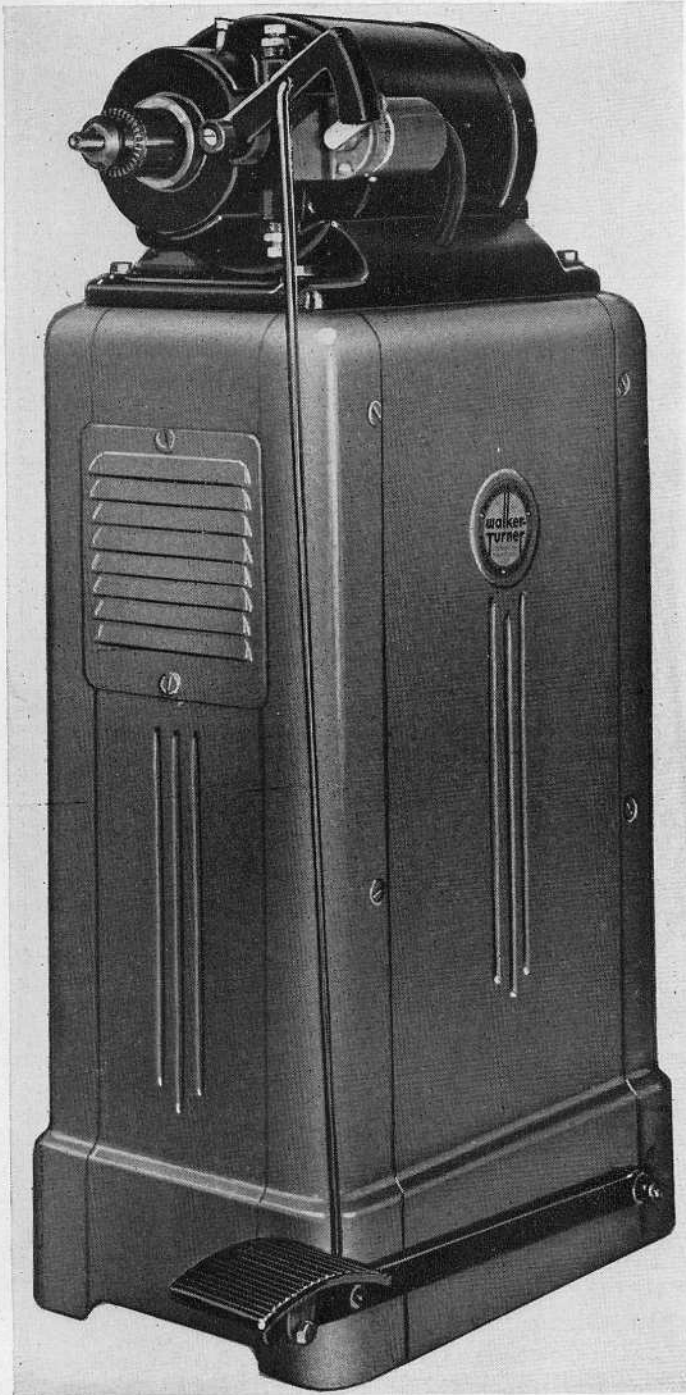

**TPL-6 SPEED LATHE**—1800 RPM; less chuck, but with  $1\frac{1}{2}$ "-8 threads per in. threaded spindle.

**TPL-7 SPEED LATHE**—3600 RPM; No. 6A Jacobs Chuck,  $\frac{1}{2}$ " capacity.

**TPL-8 SPEED LATHE**—3600 RPM; No. 59B Jacobs Chuck,  $\frac{3}{4}$ " capacity and  $4\frac{1}{2}$ " depth.

**TPL-8A SPEED LATHE**—3600 RPM; 4" Universal Chuck.

These new Walker-Turner Polishing Lathes are especially adapted for high-speed polishing and grinding of small parts not exceeding 3" or 4" in diameter, such as airplane engine valves, tappets, acorn nuts, etc.

**THE MOTOR** is a standard Walker-Turner 3 H.P. frame, wound down for  $1\frac{1}{2}$  H.P. To assure cool, safe operation, the motor is not fully enclosed, but ventilated through an air inlet located in the base of the machine. Harmful abrasive dust is settled out and does not enter the motor. Ball bearings are over-size and fully protected from dust.

**QUICK STOPS** are provided for by an automotive type brake. The control for this brake is interlocked with a drum type switch and both are actuated by a foot treadle.

**SPEEDS**—Walker-Turner Polishing Lathes are available with speeds ranging from 950 to 7200 RPM, and in combination of two speeds. (See facing page.)

The standard chucks are:  $\frac{1}{2}$ " capacity;  $\frac{3}{4}$ " capacity with a depth of  $4\frac{1}{2}$ "; and 4" universal.

Motors are all wound for  $1\frac{1}{2}$  H.P. and to operate on three phase current only. When ordering specify cycles and voltage desired.

POLISHING  
LATHES

WALKER-TURNER MACHINE TOOLS



# POLISHING LATHES

These geared motor polishing lathes were developed to meet the need for a wider range of speeds than could heretofore be obtained. The gears are protected from stalling or overloading by a patented mechanical cushion, and are guaranteed against tooth breakage due to shock loads.

**THE MOTOR** is a 3 H.P. frame wound down for 1½ H.P., and is ventilated through an air inlet in the base to assure safe, cool operation.

**AUTOMOTIVE TYPE BRAKE**, the control for which is interlocked with a drum type switch, actuated by a foot treadle, provides for quick stops.

**WIDE RANGE OF SPEEDS**—Speeds from 950 to 7200 RPM are available. Two-speed geared motors provide two speeds, either of which is instantly available through a push button control located on top of the motor.

## GEARED GRINDERS

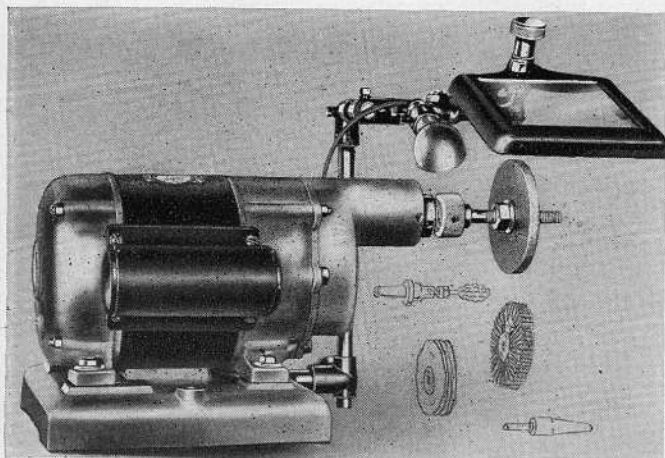

Patent Nos. — U.S.A.: 2,236,854; Great Britain 527,508; Canada: 391,285.

This ruggedly built grinder was developed several years ago for one of the most widely known airplane engine manufacturers. Since then hundreds of these machines have been put into operation in tool rooms and on production lines in factories engaged in producing airplane parts and similar types of equipment.

The over-hanging extension of the geared spindle providing complete accessibility and a high speed of 7800 R.P.M. make an ideal combination for light grinding, burring and polishing operations.

A removable work arbor and a collet chuck are supplied as standard equipment for the spindle which has a female taper. Supplied also as standard equipment is an adjustable eye shield of shatter-proof glass.

While the standard speed (60 cycle current) is 7800 R.P.M., speeds of 3600 and 4400 are also available on special order.

Motor is of the semi-enclosed type, ¾ H.P. 110-220 single phase, and is provided with rubber cord and plug.

**WAC7** — ¾ H.P. GEARED GRINDER as shown, includes ½" threaded adapter, shatterproof eye-shield and SS160 collet chuck less lamp and other accessories.

**WAC7-2**—½ H.P. TWO-SPEED GEARED GRINDER, 3600-7800 R.P.M. with push button switch. Other equipment same as WAC7.



Patent Nos. — U.S.A.: 2,236,854; Great Britain 527,508; Canada: 391,285.

**TPL-9 SPEED LATHE**—Geared motor in any of the following speeds: 950, 1500, 1800, 2200, 3000, 3600, 4400, or 7200 RPM; No. 6A Jacobs Chuck, ½" capacity.

**TPL-10 SPEED LATHE**—Same as TPL-9 except with No. 59B Jacobs Chuck, ¾" capacity with 4½" depth.

**TPL-11 SPEED LATHE**—Two-speed geared motors in any of the following combinations of speeds: 1500 and 3000 RPM; 1800 and 3600 RPM; 2200 and 4400 RPM; 3600 and 7200 RPM; No. 6A Jacobs Chuck, ½" capacity.

**TPL-12 SPEED LATHE**—Same as TPL-11, except with No. 59B Jacobs Chuck; ¾" capacity with 4½" depth.

*If Speed Lathe is wanted with 4" Universal Chuck, specify A after number, as TPL-12-A. The Universal Chuck is not recommended, because of its weight, for operation over 3600 R.P.M.*

# WALKER-TURNER MACHINE TOOLS

**POLISHING  
LATHES**

# RADIAL CUT-OFF MACHINES FOR

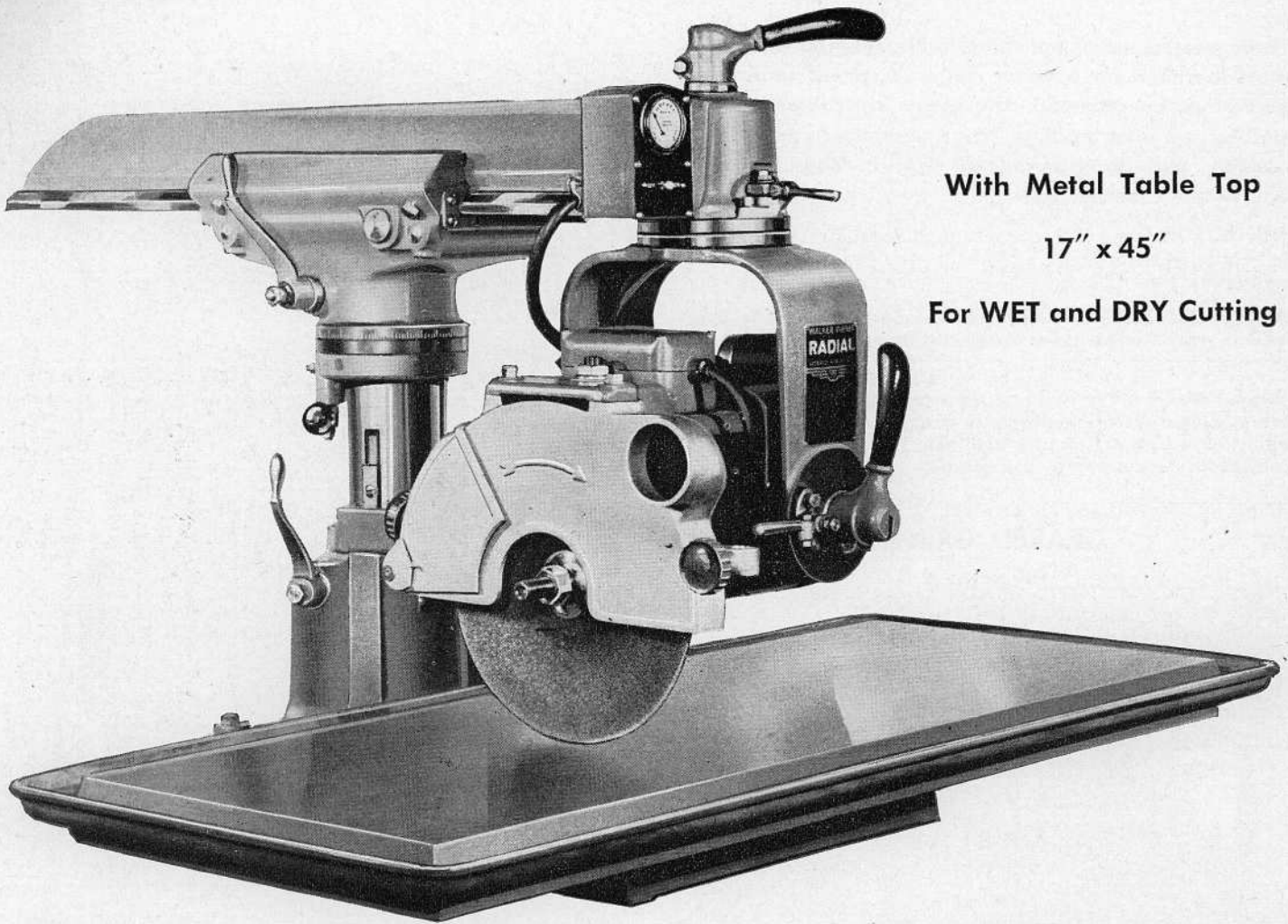

With Metal Table Top

17" x 45"

For WET and DRY Cutting

**METAL CUTTING:** On account of the wide variety of metals—different in shapes and sizes, formed into tubing or solid bars and flats, and consisting of unlimited varying degrees of hardness; we show on the opposite page an orderly grouping with general recommendations for **METAL CUTTING SAWS** for the **NON-FERROUS METALS**, and **Abrasive Wheels** for **Ceramics** and **FERROUS METALS**.

Where **STRAIGHTNESS** and **SMOOTHNESS** are desirable factors and minimum burr on hard high carbon steel tubing, etc., it is frequently economical to use the Radial Machine instead of the usual methods

where shear, torch, hacksaw or bandsawing can not give the desired result. In the cutting of heavy solids and low carbon steel shapes, or hot rolled flats and bars we do not recommend the abrasive wheel as **ECONOMICAL** except in special cases.

**TRANSVERSE TRAVEL:** Mechanical principle of operation that makes it possible to cut **WIDE** material and **DIFFERENT** shapes. Finger touch lightness with gliding ram on **EIGHT PRECISION** ball bearings—so the operator can "**FEEL THE BITE**" with **SENSITIVE CONTROL**. Very little practice is required to "feel" difference between "light rubbing" (feeding too slowly); "efficient cut-

ting" (feeling the bite); and "forcing" (feeding too heavily).

**VERY THIN WHEELS USED:** Geared motor makes possible small diameter wheels. **ONLY HALF AS MUCH WORK** is required to part material with  $\frac{1}{16}$ " thin wheel as with  $\frac{1}{8}$ " thick wheel. Only half as much material is removed.

**CONTROLLED ACCURACY:** Tapered latches and rugged locking-levers insure accurate alignment and precision cutting. Right and left hand adjusting screws provide for maintaining accuracy. Both "climb-milling" and "kick-cutting" by reversing motor end for end about position.

*Sold only through specially franchised distributors. Write for name of your local distributor.*

**RADIAL  
SAWS**

## WALKER-TURNER MACHINE TOOLS

# METALS • CERAMICS • PLASTICS

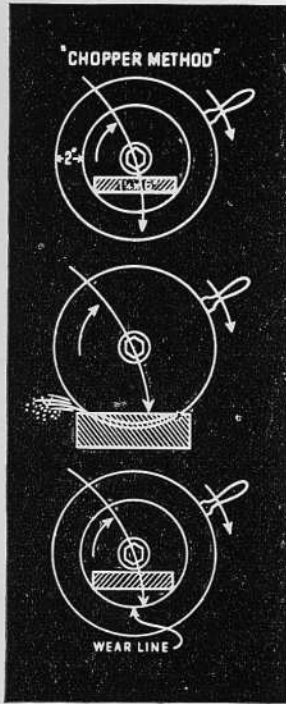

## Reasons Why It Cuts Economically

**"SLAB CUTTING" METHOD USED:** Wide flat metal stock, wide mouldings, sheets of insulating material, etc., are classified as "slab" materials on account of the WIDE cut required. The usually employed downward shearing motion classified as "chopper" method may be compared in operating principles with the "slab" cutter for CAPACITY, and EFFICIENCY OF ARC, and ECONOMY OF WHEELS.

**MORE CAPACITY:** Compare the areas of cross-section here drawn to actual scale. WIDTH and DEPTH are shown with suitable allowance for abrasive wheel wear. Actually 500% more capacity.

**"SHORT ARC" VS. "LONG ARC":** Small particles of the material being cut plus small particles of the wheel ROLL and RUB to cause friction and heat rather than cutting unless quickly released. The shorter the path they have to travel for release the better.

**ECONOMY—MORE CUTS PER WHEEL:** Abrasive wheels must be discarded when they wear down to the corner of the material by "chopper" method while "slab" method permits use until bottom line clears. 22% more utility out of EVERY wheel used—means approximately \$.45 saved on EVERY wheel—\$135.00 per year of 300 working days where only ONE wheel per day is worn out.

**UNLIMITED USEFULNESS:** Skillful design permits positioning the head so you can RIP WIDE SHEETS of metal or insulation material. You can move the material while saw is in fixed position. You can "trench" or dado, miter, compound miter, and also operate with motor in VERTICAL positions. The applications and use of this machine are limited only by the ingenuity of the operator.

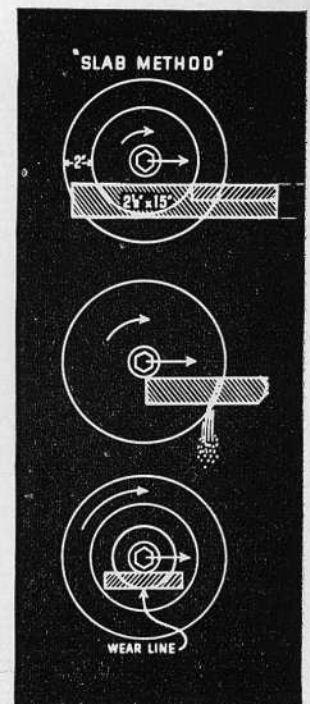

## CUTTING RECOMMENDATIONS

**GENERAL RECOMMENDATIONS** are made below for various materials. EVERY MATERIAL PRESENTS A SLIGHTLY DIFFERENT CUTTING PROBLEM. Solid bars and thin wall tubing of the SAME material require different treatment. It is IMPORTANT that you get the right blade or abrasive wheel.

**METAL CUTTING BLADES** listed are semi high speed steel — 10" Diam. — 3/4" hole — 4 expansion slots in the rim — hollow ground — properly tensioned and balanced. Harder high-speed steel blades may be ordered through us or obtained from a responsible saw manufacturer.

**ABRASIVE WHEELS** listed are for general purpose. 12" diameter — 3/8" thick — 3/4" hole. Responsible abrasive wheel manufacturers render free engineering service and make recommendations if you submit a sample of the material to be cut and request a wheel of suitable grit, bond, structure, hardness, etc., for efficiently cutting the material to give desired finish and maximum number of cuts per wheel.

Classification	Group	Material	Wheel	Metal Cut. Saw.
FERROUS METALS	High Carbon	High Speed Stellite Hardened	237-M	None
	Low Carbon	Cold Rolled Angle Iron Steel Pipe	225-M	None
	Tubing Moulding	Sheet Iron Thin Wall Tubing Mouldings	465-M	RA-5 220 Teeth
NON-FERROUS METALS	Solids Tubing Shapes Sheets	Brass, Bronze Copper Aluminum Magnes (Dow Met)	236-M	Solid-RA-7 250 Teeth 5° Tubing-RA-6 190 Teeth 12° Alum-RA-8 150 T-RG-5°
CERAMICS	HARD	Porcelain, Vitrous Tile Slate, Marble	56-M	None
	MEDIUM	Fire Brick Limestone Brake Lining	53-M	None
	SOFT	Build-Tile Transite Terra Cotta	123-M	None
PLASTICS	MEDIUM	Bakelite Catalin Hard Rubber	21-M	HSS-RA-2 112 T-Bev/P

## SPECIFICATIONS

Height Overall (with steel stand).....61"  
 Height of Steel Floor Stand.....29"  
 Size of Table Top (working surface) .....17" x 45"  
 Floor Space Required.....4' x 5'  
 Standard Ram Travel.....21 1/2"  
 Special Long Ram Travel.....28 1/2"  
 Total Vertical Adjustment.....8 1/2"  
 Spindle.....3/4" diam. x 2 1/2" long

### SHIPPING WEIGHT

lbs.  
 Machine with 1 H.P. Motor.....445  
 Machine with 3 H.P. Motor.....555  
 Metal Table Top.....185  
 Steel Floor Stand.....125

**MRA1112—RADIAL SAW**, as shown on page 26, including 1 H.P., single phase, 110-220 volt, 60 cycle, A.C., 3450 R.P.M. Motor, less abrasive wheel.

**MRA1115—RADIAL SAW**, same as MRA1112, except with 1 1/2 H.P., three phase, 220 volt, 60 cycle, A.C., 3450 R.P.M. Motor, less abrasive wheel and magnetic overload release.

**MRA1120—RADIAL SAW**, same as MRA1112, except with 2 H.P., single phase, 110-220 volt, 60 cycle, A.C., 3450 R.P.M. Motor, less abrasive wheel.

**MRA1130—RADIAL SAW**, same as MRA1112, except with 3 H.P., three phase, 220 volt, 60 cycle, A.C., 3450 R.P.M. Motor, less abrasive wheel and magnetic overload release.

If Radial Saw is wanted with Long Ram, specify S after number, as MRA1112-S.

(Odd voltage, phase and cycle motors available on special order at extra cost).

Sold only through specially franchised distributors. Write for name of your local distributor.

# WALKER-TURNER MACHINE TOOLS



# RADIAL SAWS FOR WOODWORKING

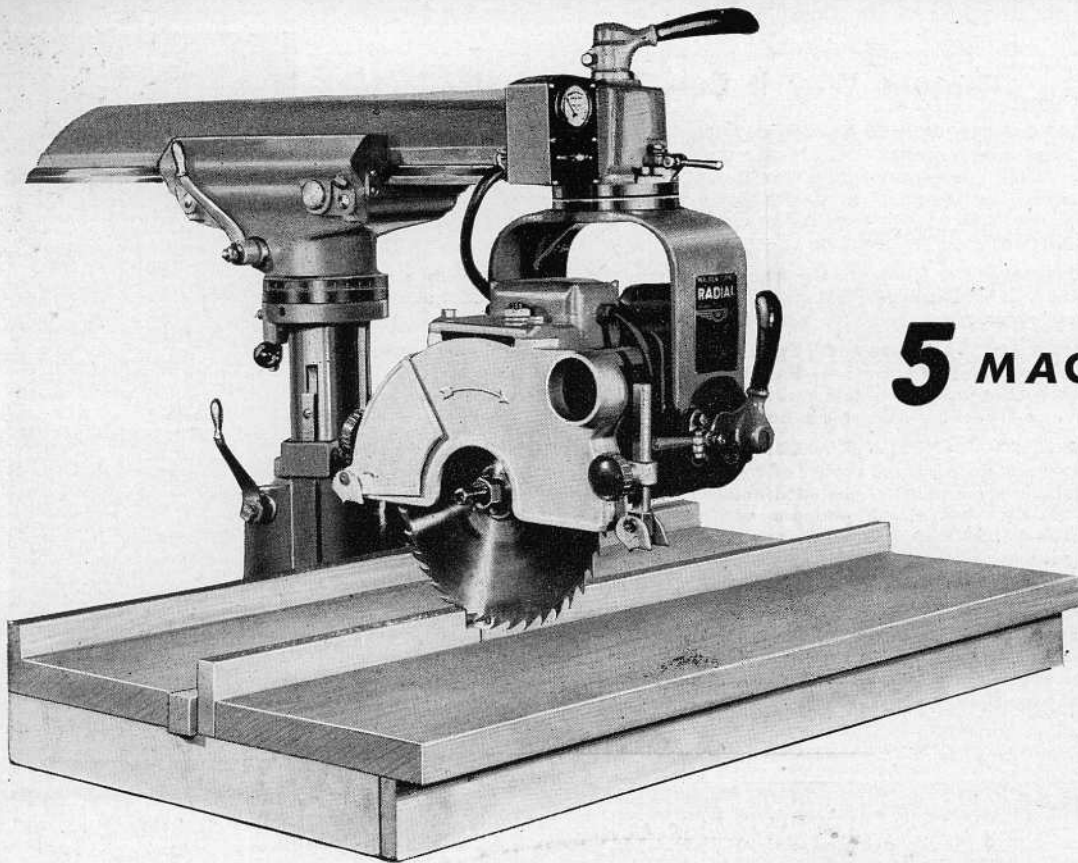

## 5 MACHINES IN 1

- ① SAWING
- ② DADOING
- ③ SHAPER
- ④ ROUTER
- ⑤ TENONER

### Built for Long Dependable Service

**MODERN DESIGN:** Correct mechanical principles — balanced power — skillful arrangement for taking care of structural stresses and strains so accurate performance is assured and maintained.

**GLIDING RAM:** Moves 21½" with finger touch lightness on 8 precision Ball-Bearings. Operator has clear view of work and no interference from overhanging arm extending out over the table.

**UNIVERSAL HEAD:** Convenient locating latches and locking levers for quick change and rigid setting. Mechanical adjustments for maintaining accurate alignment.

**GEARED MOTOR:** Equipped with a patented "SHOCK ABSORBER" or mechanical cushion — an exclusive feature — U. S. Patent No. 2,236,854.

**SAFETY GUARD:** With adjustable segment for covering otherwise exposed part of saw blade — double kick-backs provided both front and rear.

**MAPLE TABLE TOP:** Selected kiln dried maple laminated — 46" x 24" — removable center fence with quick change wedges. Rigidly supported on ONE PIECE base extending out under table to support it and insure ACCURACY.

**PORTABLE:** Quickly divided into TWO parts by loosening only one lever. Each part approximately 200 lbs. To make FOUR parts table top and Universal head may be removed.

**VOLTMETER:** Indicates line voltage. Protects against operating on "drop in voltage." Magnetic Overload release and quick change voltage box are standard equipment on all single phase machines.

**UNEQUALLED CAPACITY:** Rips 38" wide. Travels 21½" to cut material 4¾" deep with 12" blade. For mitering, compound mitering, shaping and routing its capacity is unequalled.

*Sold only through specially franchised distributors. Write for name of your local distributor.*

RADIAL  
SAWS

WALKER-TURNER MACHINE TOOLS

# RADIAL SAWS FOR WOODWORKING

## The Mechanical Advantages of the Geared Motor

**MORE CAPACITY:** Deeper cuts with small diameter blades are made possible by bringing the shaft down close to the work. Inexpensive wide Dado Heads are NOT heavy but light and safe.

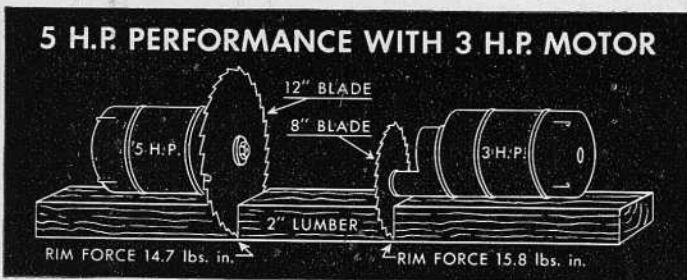

12" blade cuts . . . . . 4 3/4"    8" blade or Dado . . . . . 3 3/4"  
 10" blade cuts . . . . . 3 3/4"    6" Dado Head . . . . . 1 3/4"  
 2" x 8" Jack Rafters are cut with 10" saw.

*(Deduct only 1/2" capacity for larger 2 & 3 HP Motors)*

**MORE RIM FORCE:** Since the WORK is actually done at the TOOTH of the saw or the RIM—the greater the RIM FORCE the harder to "stall" the blade. Rim force is approximately DOUBLED.

**"MECHANICAL CUSHION" IN GEARS:** Protection against gear tooth breaking through shock loads. The rotor of the motor revolving at high speeds has the momentum of a fly-wheel that tends to "carry on" when blade is suddenly stopped — gear teeth break unless there is a "shock-absorber." Only three simple parts — spring steel washer — cone — driving gear. No resetting required. An exclusive patented feature.

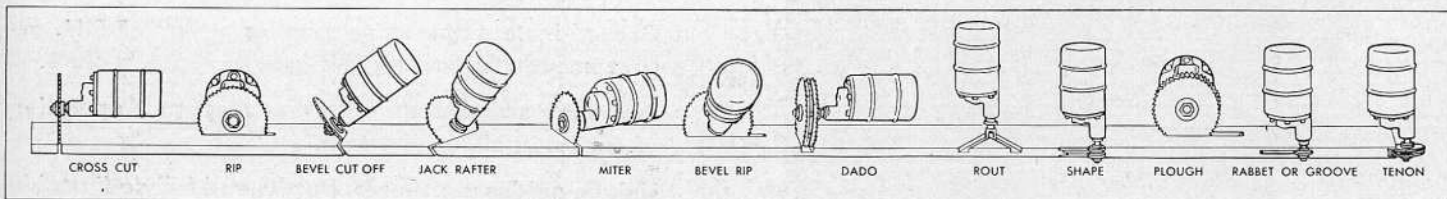
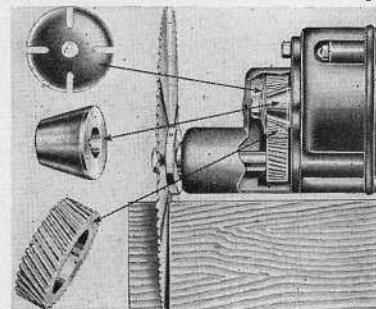

## Who Uses the W-T Radial Saw?

**WOODWORKING SHOPS:** Planing Mills; Cabinetmakers; Stair-Builders; Carpenter Shops; Furniture Factories; Store Fixtures.

**LUMBER YARDS:** Small Lumber Yards; Line Yards; Light Millwork.

**FACTORIES AND INDUSTRY:** Pattern-Shop; Maintenance Dept; Shipping Dept.

**BUILDERS AND CONTRACTORS:** House Builders; Concrete Forms; Row Operations; Prefabrication Jobs.

**RA1104—RADIAL SAW COMPLETE**, as shown on page 28, including 1 H.P., single phase, 110/220 volt, 60 cycle, 3450 R.P.M., A.C. Motor, and 10" blade.

**RA1105—RADIAL SAW**, same as RA1104, except less Laminated Maple Table Top, Motor and blade.

**RA1106—RADIAL SAW**, same as RA1104, except with 1 1/2" H.P., three phase, 220 volt, 60 cycle, 3450 R.P.M., A.C., Motor, and without magnetic overload release.

**RA1107—RADIAL SAW**, same as RA1104, except with 2 H.P., single phase, 220 volt, 60 cycle, 3000 R.P.M., A.C. Motor, and 12" blade instead of 10".

**RA1108—RADIAL SAW**, same as RA1107, except with 3 H.P., three phase, 220 volt, 60 cycle, 3000 R.P.M., A.C., Motor, and without magnetic overload release.

**RA185—MAPLE TABLE TOP**, laminated, 46" x 24".

**RA150—STEEL FLOOR STAND.**

*(Odd voltage, phase and cycle motors available on special order at extra cost.)*

If Radial Saw is wanted with Long Ram, specify S after number, as MRA1112-S.

## SPECIFICATIONS

Height Overall (with steel stand) . . . . . 61"  
 Height of Steel Floor Stand . . . . . 29"  
 Size of Table Top . . . . . 46" x 24"  
 Floor Space Required . . . . . 4' x 5'  
 Standard Ram Travel . . . . . 21 1/2"  
 Special Long Ram Travel . . . . . 28 1/2"  
 Total Vertical Adjustment . . . . . 8 1/2"  
 Saw Spindle—3/4" Diam. 2 1/2" long.

**Depth of Cut with 1 H.P. and 1 1/2 H.P. Motors**  
 8" Blade—2 3/4" deep.  
 10" Blade—3 3/4" deep.  
 12" Blade—4 3/4" deep.

*(Deduct only 1/2" for 2 or 3 H.P. Motors)*

**SHIPPING WEIGHT LBS.**  
 Machine, with 1 H.P. Motor . . . . . 445  
 Machine, with 3 H.P. Motor . . . . . 555  
 Maple Table Top . . . . . 75  
 Steel Floor Stand . . . . . 125  
 Metal Table Top . . . . . 185

*(See pages 32 and 33 for accessories.)*

# WALKER-TURNER MACHINE TOOLS

## RADIAL SAWS

# SPINDLE SHAPERS FOR

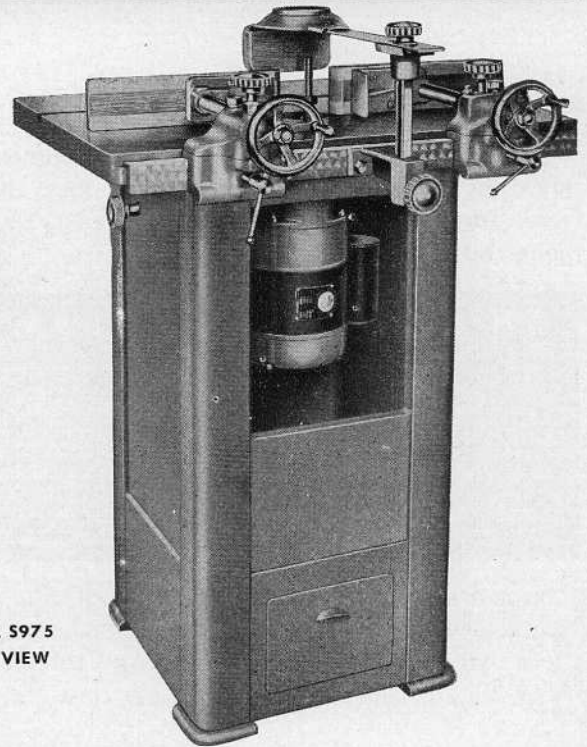

MODEL 5975  
REAR VIEW

Geared motors operating spindles at 7600 R.P.M. assure smooth, fast cutting. No belts to slip or replace.

Reversing switches on both models permit operation of cutters in either direction.

Unique guides are simple, sturdy, and fully adjustable . . . instantly removable for interior work.

Patent Nos.  
U.S.A.: 2,236,854  
Great Britain: 527,508  
Canada: 391,285

5975—Floor model shaper, as shown, including arbor for holding  $\frac{3}{4}$ " bore tools, 2 guide pins, a set of spanner wrenches and all guards and guides; less motor and switch.

9550—Front extension table 8"x27" cast-iron.

9513A—Arbor for cutters with  $\frac{1}{2}$ " bore.

Select motor from the following:

GB105—1 H.P., geared motor, 110-220 volts, 60 cycles, AC, 7600 R.P.M.

GB155— $1\frac{1}{2}$  H.P., 3 phase geared motor, 220 volts, 60 cycles, AC, 7600 R.P.M.

\*GB205—2 H.P., geared motor, 220 volts, 60 cycles, AC, 7600 R.P.M.

\*GB305—3 H.P., 3 phase geared motor, 220 volts, 60 cycles, AC, 7600 R.P.M.

\*When using GB205 or GB305 specify Machine No. S975L.

Drum type reversing switch included with all shaper motors.

**Motors and elevating mechanisms are assembled as units and attached to under side of table.**

**MOTOR ASSEMBLY BOLTED RIGIDLY TO TABLE**—Structural details as illustrated at right with the exception of the hand wheel are common to both "700" and "900" models. Note how the entire mechanism is suspended from under side of table, the dovetailed ways on which the motor is raised or lowered, and the adjustable gibs to take up wear. No detail has been overlooked.

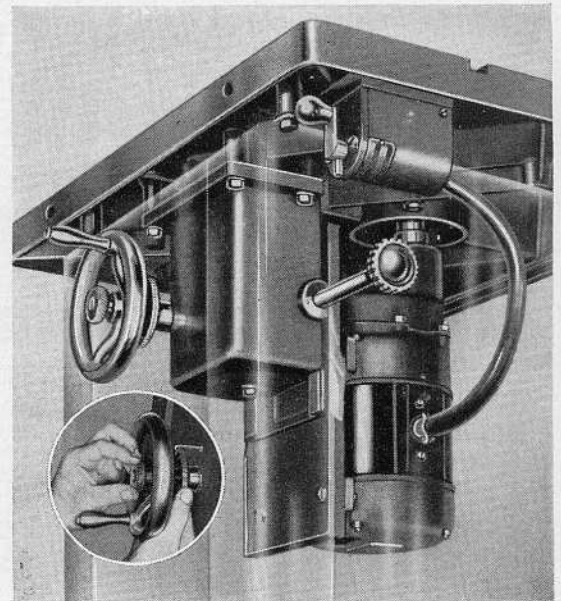

(See page 31 for Arbors)

**SPINDLE  
SHAPERS**

**WALKER-TURNER MACHINE TOOLS**

# ALUMINUM • PLASTICS • WOOD

Motors are raised or lowered on dovetail ways with adjustable gibs.

4 tapered arbors for holding cutters with  $\frac{5}{16}$ ",  $\frac{1}{2}$ ",  $\frac{5}{8}$ ",  $\frac{3}{4}$ " bore available.

Starting pins for irregular shaped work supplied.

Vernier dial indicator on elevating control can be reset for fine vertical movement.

Bases are extra heavy welded steel construction. Sub-base available for bench model.

**GEARED MOTOR (Right)** — Gear transmission has an efficiency of better than 97%. Drawing shows bearing construction of the 2 H.P. geared motor. The  $\frac{1}{2}$ ,  $\frac{3}{4}$ , 1 and  $1\frac{1}{2}$  H.P. geared motors have single row ball bearing at spindle end.

**IRREGULAR SHAPING (Below, left)** — Done without guides, using the starting pin and depth collars. Pins are regular equipment.

**FEATURES (Below, right)** — Photo shows spring hold-downs, guard overarm and wood-faced, fully adjustable guides. Note ample working area of table and milled groove for mitre gauge or shaping jig.

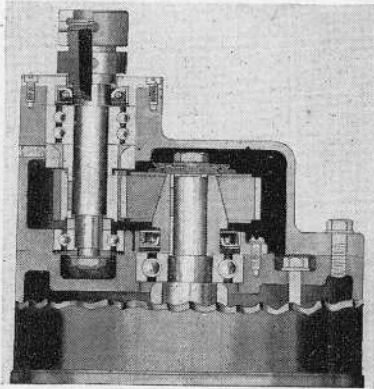

Patent Nos.  
U.S.A.: 2,236,854  
Great Britain: 527,508  
Canada: 391,285

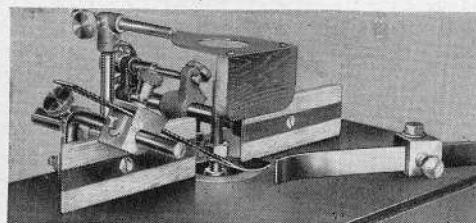
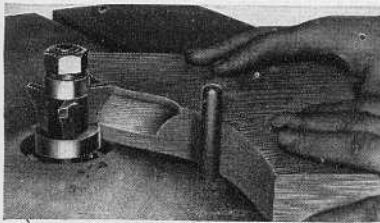

## SPECIFICATIONS

**DRIVE:** geared motor with operating spindle turning at 7600 R.P.M. through scientifically designed gears.

**ARBORS:** four interchangeable arbors for  $\frac{5}{16}$ ",  $\frac{1}{2}$ ",  $\frac{5}{8}$ " and  $\frac{3}{4}$ " bore cutters are available.

**MOTOR AND ELEVATING MECHANISM:** securely bolted to underside of table. Heavy cast-iron dovetail ways with take-up gibs guide motor unit.

**BEARINGS:** two precision, dust-sealed ball bearings on motor shaft and two on gear shaft.

**ELEVATING MECHANISM:** motor assembly moved up or down by micromatic mechanism with vernier dial indicator. Travel  $2\frac{3}{4}$ ".

**REVERSING SWITCH:** drum type, conveniently located under the table. Switches included with single phase motors.

**TABLES:** close-grained gray iron ribbed for rigidity and strength. Top ground and polished. Groove for mitre gauge milled in. Extension table 8" wide available for S975. Attaches to front of table.

**STARTING PINS:** 2 supplied with floor model. Have tapered ends to fit tapered holes in table. Bench model has single pin with threaded end.

**GUARD AND HOLD-DOWN:** mounted at rear of table. Spring steel overarm makes effective hold-down while protecting the operator.

**GUIDES:** made up of two units independently adjustable. Guides on both models have wood facings  $3\frac{1}{4}$ " high. Floor model guides are of heavier construction and have provision for an extra lateral adjustment.

**SUB-BASE:** with laminated wood top available for bench model.

**SHIPPING WEIGHT:** less motor approximately 175 lbs. for Bench Model and 315 lbs. for Floor Model.

	S750	S975
Table Size	21" x 16"	27" x 20"
Distance,		
spindle to front of table	11 $\frac{1}{2}$ "	14"
spindle to rear of table	33 $\frac{1}{4}$ "	6"
spindle to sides of table	10 $\frac{1}{4}$ "	13 $\frac{1}{2}$ "
Height to top of table	17 $\frac{1}{4}$ "	35"
Shipping weight approx.	175 lbs.	315 lbs.

**Rear View** — Note how completely motor and mechanism are enclosed. Also how fully adjustable are the guides, guard overarm and spring hold-downs.

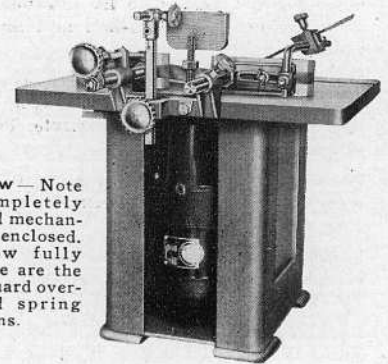

**S750**—Bench model shaper as shown including arbor for holding  $\frac{1}{2}$ " bore cutters, guide pin, a set of spanner wrenches and all guards and guides; less motor and hold-downs.

**Select motor from the following:**

**GB55**— $\frac{1}{2}$  H.P., geared motor, 110-220 volts, AC, 60 cycles, 7600 R.P.M.

**GB105**—1 H.P., geared motor, 110-220 volts, AC, 60 cycles, 7600 R.P.M.

Drum type reversing switch included with GB55 and GB105.

**558X**—Set of spring hold-downs.

**19**—Heavy steel sub-base 19 $\frac{3}{4}$ " long x 17 $\frac{1}{4}$ " wide x 18" high.

**9513**—Arbor for cutters with  $\frac{5}{16}$ " bore.

**9513B**—Arbor for cutters with  $\frac{5}{8}$ " bore.

**9575**—Arbor for cutters with  $\frac{3}{4}$ " bore.

# WALKER-TURNER MACHINE TOOLS

SPINDLE  
SHAPERS

# SHAPING ACCESSORIES FOR

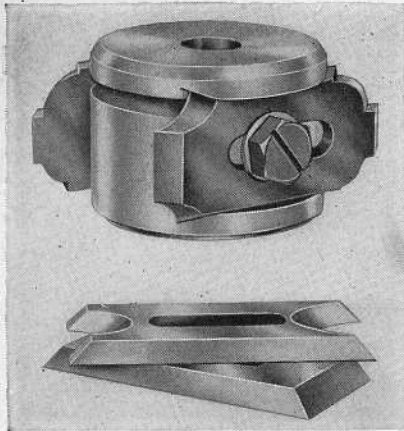

**NEW MOLDING HEAD AND KNIVES**—Combining the strength of steel with the lightness of aluminum this new molding head of heat-treated duralumin is approximately one-third the weight of a steel head of similar dimensions. The elimination of needless weight minimizes vibration insuring smoother cuts and more accurate work. The bevelled edged tool steel knives are anchored in position for accurate safe cutting. It is impossible for the knives to fly out because they are held by U-collars and anchor bolts.

**RA225**—Molding Head (less knives)  $\frac{3}{4}$ " bore x  $2\frac{1}{2}$ " diameter x  $1\frac{7}{8}$ " wide with knives inserted. 4" cutting circle. Width of knives,  $1\frac{3}{8}$ ".

**RA225-1**—Straight-face knives (pair) beveled knife stock,  $1\frac{3}{8}$ " cutting edge x 3" long x  $\frac{1}{4}$ " thick.

**RA225-3**—Stair nosing knives (pair) beveled knife stock,  $1\frac{3}{8}$ " wide x 3" long x  $\frac{1}{4}$ " thick. Cut  $\frac{9}{16}$ " and  $\frac{7}{16}$ " radius.

**RA225-6**—Radius knives (pair) beveled knife stock,  $1\frac{3}{8}$ " wide x 3" long x  $\frac{1}{4}$ " thick. Cut  $\frac{3}{8}$ " and  $\frac{1}{4}$ ", in and out.

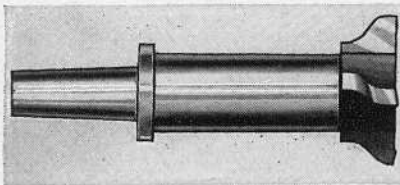

**COPE CUTTER AND ARBOR**—This combination is used for sash work. Cope cutter screws on to threaded end of arbor which slides into hollow spindle of S975 Shaper motor.

**SS62**— $\frac{1}{2}$ " Cope Cutter, with arbor and lock screw.

**SS62A**— $\frac{1}{2}$ " Cope Cutter only.

## WALKER-TURNER SHAPING TOOLS HAVE A WIDE VARIETY OF USES

Walker-Turner shapers are not one-operation machines—for shaping only. With their wide selection of accessories they have extra utility, and handle many diversified operations efficiently. They are designed for multiple application. Besides shaping they may be used for sanding, dadoing, tenoning, reeding, fluting, panel carving and for making lock corners (used in box and drawer manufacture).

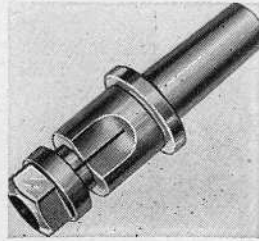

**COLLET CHUCKS**—The arbors of these collet chucks lock securely in place in the spindle of the shaper. With these collets the carving cutters below, small shaped grinding stones, the DS30, DS20 and DS15 Sanding drums and other accessories having  $\frac{5}{16}$ " or  $\frac{1}{4}$ " shanks may be used on the shaper.

**SS160** — Collet Chuck for  $\frac{5}{16}$ " shanks.

**SS161** — Collet Chuck for  $\frac{3}{4}$ " shanks.

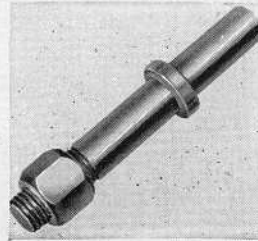

**D. P. ADAPTER** — The  $\frac{5}{16}$ " cutters listed on page 27 may be used on the drill press with this  $\frac{5}{16}$ " Drill Press Adapter. The cutter is attached to the threaded end and the opposite end held in the collet chuck, 7D11, or in the Jacobs chuck which is standard equipment on W-T drill presses. See page 10 for drill press shaping accessories.

**DP120** — Adapter for  $\frac{5}{16}$ " cutters.

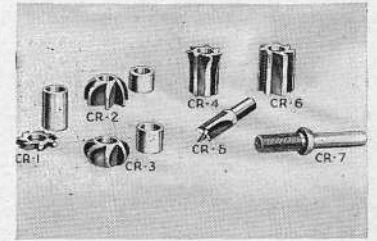

**CARVING CUTTERS**—Fine carvings can be made with the cutters illustrated above. All of the cutters excepting CR5 screw on to the threaded shank CR7.

**CR1**—Liner                      **CR5**—Button Drill

**CR2**—Half Round              **CR6**—Straight Face

**CR3**—Round Nose          **CR7**—Ext. Shank  $\frac{5}{16}$ " diam. for holding cutters.

**CR4**—Hook Tool

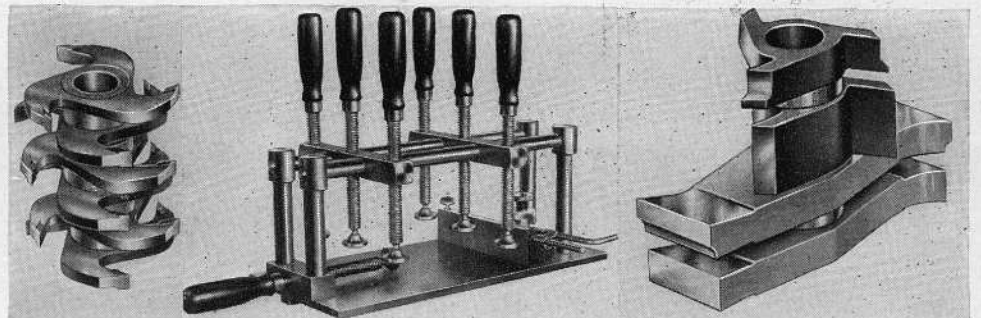

**CORNER CUTTERS**—These lock joint corner cutters are used for cutting lock corner joints commonly found in the construction of drawer and box corners. The set consists of 6 cutters and spacers  $\frac{1}{4}$ " thick. All made of selected steel carefully ground. Available with  $\frac{5}{8}$ " and  $\frac{3}{4}$ " bores. These fine cutters will be found useful not only to the manufacturer or cabinet shop but to the home craftsman.

**SS65**—Set of cutters,  $\frac{5}{8}$ " hole.  $2\frac{1}{2}$ " O. D.

**SS67**—Set of cutters,  $\frac{3}{4}$ " hole.  $2\frac{1}{2}$ " O. D.

**SHAPING JIG**—Greater safety and accuracy when shaping across the grain or handling small pieces are assured with this attachment. The work is clamped in position on the jig and the whole assembly slid through the mitre gauge slot. Used on S975 Shaper for holding work to be shaped across the grain or for cutting lock corner joints. The base is a heavy steel plate and the uprights and bars large diameter steel rods. A self-indexing mitre gauge built in for accurate angle work.

**9S15**—Shaping Jig.

**SASH CUTTER SET**—Adaptable for many kinds of commercial moldings . . . unusually low priced . . . finest quality.

**RA23X**—Sash cutter set  $\frac{3}{4}$ " bore Consists of

**RA230-1**—Cope and Tenon cutter.

**RA230-2**—Rabbeting and Tenon cutter.

**RA235-3/8"** Spacer washer, bore  $\frac{3}{4}$ ".

**RA235-3-1"** Rabbeting cutter.

**RA235-2**—Ovolo Sash cutter (3 wings).

SHAPING  
ACCESSORIES

# WALKER-TURNER MACHINE TOOLS



# RADIAL SAW and SPINDLE SHAPERS

## 3 WING SHAPING CUTTERS

Walker-Turner 3-wing cutters are made from selected tool steel, accurately ground and carefully tempered. They have three cutting edges and are made in one piece. This type cutter is by far the safest to use.

For use on both the Shapers and the Radial these accurately ground cutters may be used singly or in combination. Besides the cuts made with single cutters many others can be formed by using various combinations mounted together on the arbor.

The variety of shapes plus the low prices make these cutters ideal for use in forming commercial moldings.

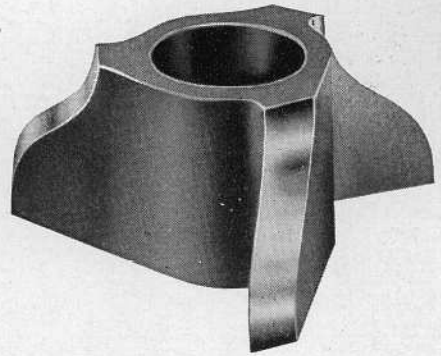

### $\frac{5}{8}$ " and $\frac{3}{4}$ " BORE SHAPING CUTTERS

These cutters have 2 bores,  $\frac{5}{8}$ " and  $\frac{3}{4}$ ". SS51 has a  $\frac{5}{8}$ " bore. If this type cutter is wanted with a  $\frac{3}{4}$ " bore put a "9" before the number — as 9SS51.

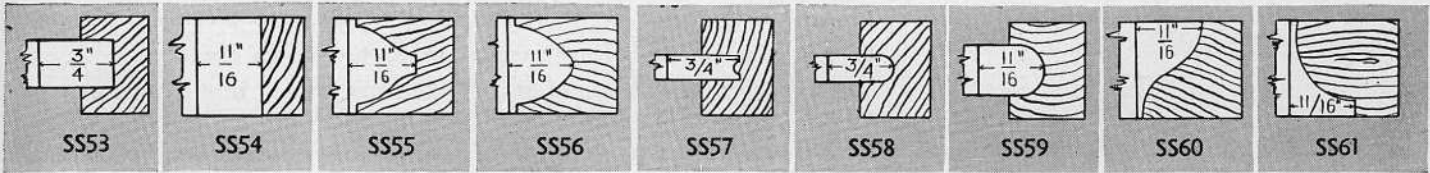

- |   |                                |                                    |                                  |
|---|--------------------------------|------------------------------------|----------------------------------|
| SS51— $\frac{1}{8}$ " Straight face cutter. | SS54— 1" Straight face cutter. | SS57— $\frac{1}{4}$ " Bead cutter. | SS60— 1" Ogee cutter.            |
| SS52— $\frac{3}{4}$ " Straight face cutter. | SS55— 1" Double ogee cutter.   | SS58— $\frac{1}{4}$ " Cove cutter. | SS61—1" Quarter Elliptic cutter. |
| SS53— $\frac{1}{2}$ " Straight face cutter. | SS56— 1" Round Nose cutter.    | SS59— $\frac{1}{2}$ " Cove cutter. | SS64—Set of 5 depth collars.     |

### $\frac{1}{2}$ " BORE SHAPING CUTTERS 1" FACE

(Not adaptable for Radial Saw)

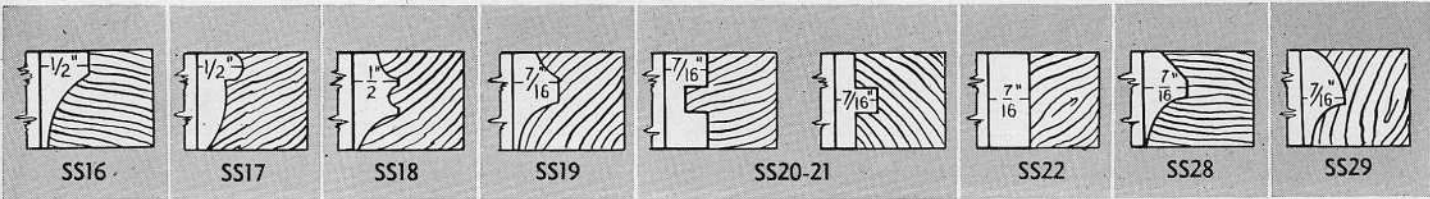

- |                     |  |   |                              |
|---------------------|--|---|------------------------------|
| SS16—Shaper cutter. | SS19—Shaper cutter.  | SS22— 1" Straight face cutter.              | SS28— 1" Joint Bead cutter.  |
| SS17—Shaper cutter. | SS20-SS21 — Set of two matched $\frac{1}{4}$ " tongue and groove cutters, set. | SS25— $\frac{1}{4}$ " Straight face cutter. | SS29— 1" Joint Cove cutter.  |
| SS18—Shaper cutter. |  | SS26— $\frac{1}{2}$ " Straight face cutter. | SS50—Set of 5 depth collars. |

### $\frac{5}{16}$ " BORE SHAPING CUTTERS

(Not adaptable for Radial Saw)

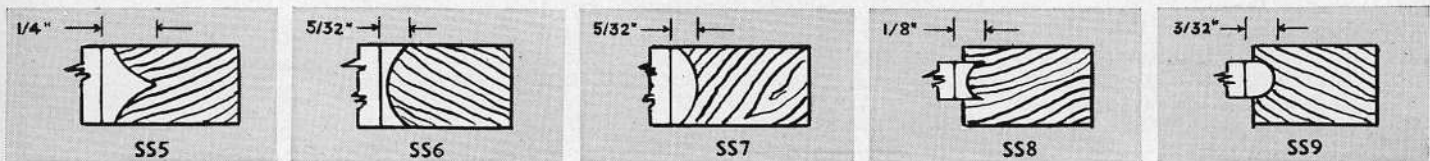

- |   |   |  |
|---|---|--|
| SS5—Fluting cutter $\frac{3}{8}$ " face.          | SS7—Cove cutter $\frac{3}{8}$ " face.             | SS9—Cove cutter $\frac{5}{16}$ " face. |
| SS6—Corner rounding cutter $\frac{5}{16}$ " face. | SS8—Corner rounding cutter $\frac{5}{16}$ " face. | SS14—Set of depth collars.             |

# WALKER-TURNER MACHINE TOOLS

SHAPING  
ACCESSORIES

# 16" and 14" BAND SAWS for CUTTING

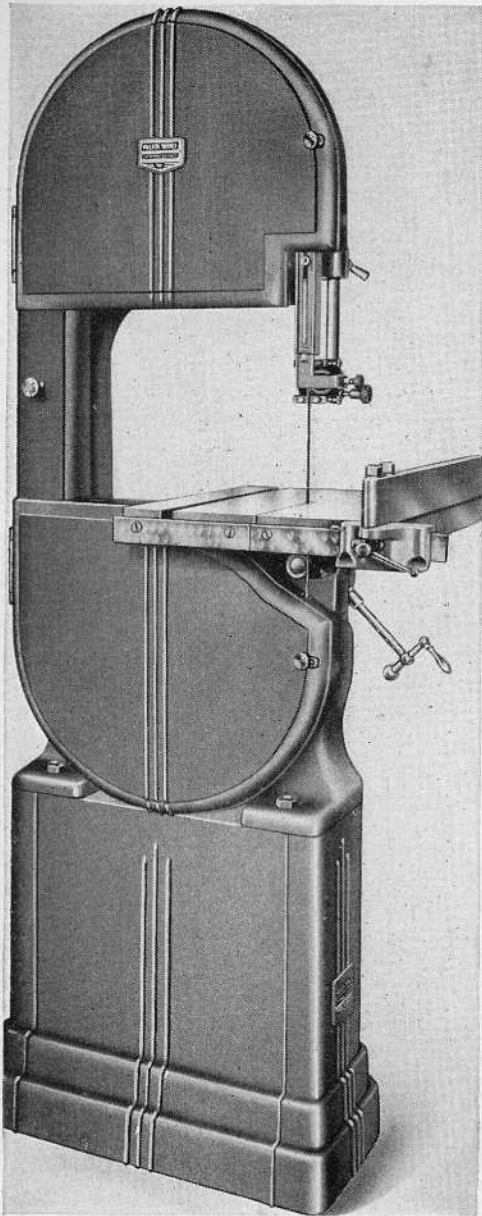

**BN1135**—16" Band Saw, as shown, less motor, ripping fence and base. Includes  $\frac{3}{8}$ " blade, motor bracket, belt and motor pulley.

**KAB55**—Special  $\frac{1}{2}$ " H.P. 1740 R.P.M. Motor, 110-220 volts A.C. 60 cycle.

**11BN45**—Base with motor bracket.

**MG90**—Self-indexing mitre gauge.

**11BN7**—Front extension table (14"x10") with rip fence (Fits 16" and 14" models).

**9BN58**—Support bar for use with 11BN7.

**EL5**—Flexo Lamp.

**11BN2**—Belt Guard (used when motor is mounted at rear or below).

**9BN81**—Rip fence and guide bar.

In hundreds of woodworking plants, pattern shops, vocational schools and general industrial plants these Walker-Turner 16" and 14" metal cutting band saws are setting new records of performance, speeding production, or saving money.

Every woodworker will appreciate the extra capacity under the upper guide, the efficient blade-tensioning and wheel-aligning mechanism, the friction-free ball bearing blade guides and the large table areas. These practical features have enabled many shops to replace older, bigger and much more expensive band saws with these Walker-Turner models and save money.

All wheel bearings heavy duty precision ball bearings.

Tables are heavily ribbed and carefully machined, tilt to 45° one direction, 5° the other.

Wheels carefully balanced and rubber faced.

Blade guides have ball-bearing thrust wheels and oil-impregnated bronze guide blocks.

Blade tensioning devices have spring cushions to absorb shocks.

Guard construction assures complete protection to operator.

12" capacity on 16" model and 7" capacity on 14" model between upper guides and tables afford unusual capacity.

Heavy cast-iron, one-piece frames have extra strength and rigidity.

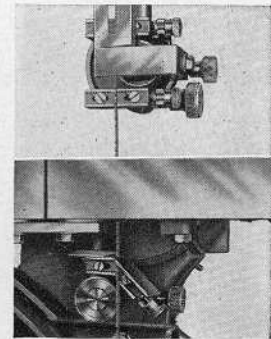
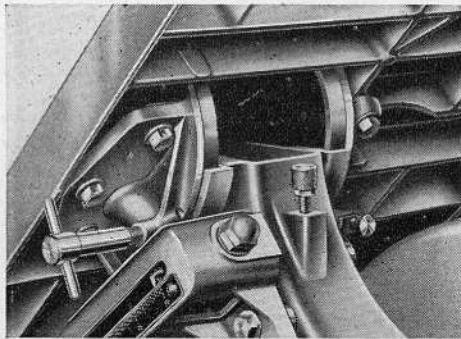

## SPECIFICATIONS

**WHEELS:** Gray iron carefully machined and balanced, rubber faced.

**BALL-BEARINGS:** Large dust-sealed, precision in both wheels.

**GUIDES:** Are both ball-bearing with adjustable oil-impregnated bronze blocks.

**WHEEL GUARDS:** Are cast-iron, hinged for convenience . . . telescoping guards at area of operation.

**ADJUSTING MECHANISM:** For blade and upper wheel mounted on two heavy ground steel rods . . . cushion springs absorb blade shocks.

**MOTOR BRACKET:** At rear of frame supplied.

Capacity, blade to frame . . . . . 16"

Capacity, guide to table . . . . . 12"

Table size . . . . . 18" x 17"

Blade speeds, ft. per min.,

standard motor . . . . . 2900

Machine speeds, R.P.M.,

standard motor . . . . . 680

Height overall, without base . . . . . 50 $\frac{1}{2}$ "

Height overall, with base . . . . . 71 $\frac{1}{2}$ "

Width . . . . . 30 $\frac{1}{2}$ "

Distance front to back . . . . . 22"

Shipping weight, without base or motor,

approx. . . . . 340 lbs.

Shipping weight, with base, less motor,

approx. . . . . 460 lbs.

### BLADES

CATALOG NO.	WIDTH	LENGTH	PRICE
11BN25	$\frac{1}{4}$ "	114 $\frac{3}{4}$	
11BN38	$\frac{3}{8}$ "	114 $\frac{3}{4}$	
11BN50	$\frac{1}{2}$ "	114 $\frac{3}{4}$	
11BN75	$\frac{3}{4}$ "	114 $\frac{3}{4}$	

(For information on other Band Saws see pages 12 and 13)

**BAND  
SAWS**

**WALKER-TURNER MACHINE TOOLS**

# NON-FERROUS METALS • PLASTICS • WOOD

**EFFICIENT, BALL-BEARING GUIDES**—No skimping on W-T blade guides, the thrust is taken by ball-bearing rollers. Adjustable blocks are made of oil-impregnated iron to lessen blade friction and reduce heating . . . another exclusive Walker-Turner feature!

**TABLES TILT ON CLOSE FITTING TRUNNIONS**—The large heavy tables are rigidly supported by heavy brackets, and tilt on sturdy, close fitting trunnions. Adjustable stops can be set permanently to the finest degree of accuracy. Scientific arrangement of table ribs minimizes warping. Soft metal table inserts around blades prevent damage due to accidental contact.

**POSITIVE ADJUSTMENT OF UPPER WHEEL**—The blade-tensioning and wheel-aligning mechanism is simple and sturdy. The wheel at bottom, see illustration, controls tracking of the blade while the upper wheel governs blade tension. A cushion spring absorbs shocks.

**SCREW TYPE TABLE TILTING MECHANISM**—The table is tilted easily and positively by means of the screw feed mechanism shown above. Degree of tilt is shown at all times by an indicating pin. Used on 16" models only.

**16" MODEL CUTS FULL 12" STOCK**—A full 12" cut is possible with the 16" model, 7" being the maximum depth of cut possible with the 14" model. This extra capacity will prove invaluable at times when there are unusually large pieces to be cut. Manufacturers of artificial or dry ice or other bulky products will find these machines well adapted to their needs. The smooth, effortless cutting of the Walker-Turner 16" and 14" band saws is undeniable evidence of great reserve power, and strength, finely balanced parts, accurate machine work and correct design.

For complete information of various applications of Walker-Turner band saws see your local distributor.

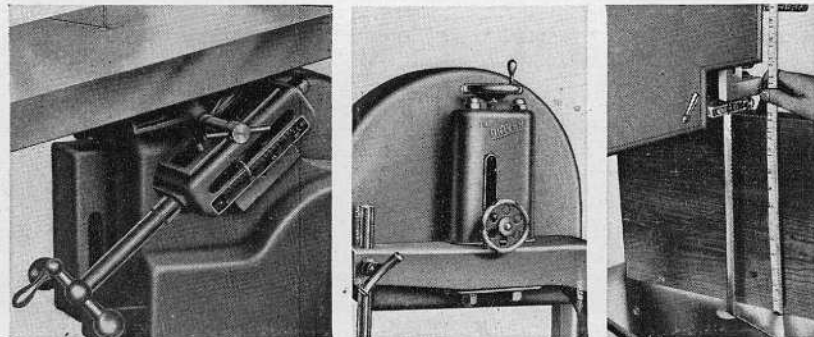
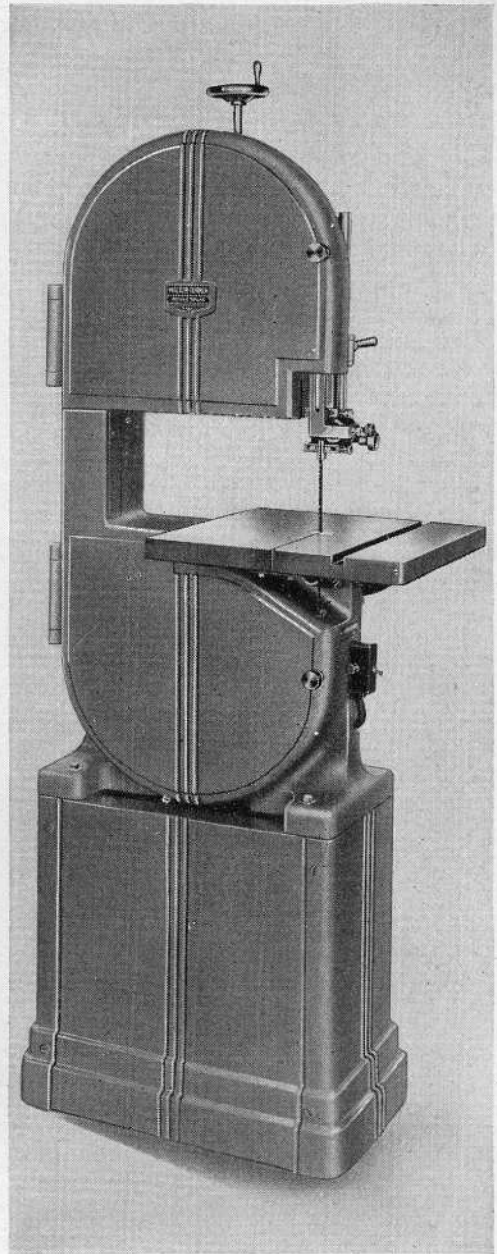

## SPECIFICATIONS

**WHEELS:** Gray iron carefully machined and balanced, rubber faced.

**BALL-BEARINGS:** Large dust-sealed, precision in both wheels.

**GUIDES:** Are both ball-bearing with adjustable oil-impregnated bronze blocks.

**WHEEL GUARDS:** Are cast-iron, hinged for convenience . . . telescoping guards at area of operation.

**ADJUSTING MECHANISM:** For blade and upper wheel mounted on two heavy ground steel rods . . . cushion springs absorb blade shocks.

**MOTOR BRACKET:** Available as an extra.

Capacity, blade to frame . . . . . 14

Capacity, guide to table . . . . . 7"

Table size . . . . . 16" x 16"

Blade speeds, ft. per min.,  
standard motor . . . . . 2535

Machine speeds, R.P.M.,  
standard motor . . . . . 680

Height overall, without base . . . . . 44"

Height overall, with base . . . . . 65"

Width . . . . . 25 3/4"

Distance, front to back . . . . . 20"

Shipping weight, without base or motor,  
approx. . . . . 285 lbs.

Shipping weight, with base, less motor,  
approx. . . . . 405 lbs.

### BLADES

CATALOG NO.	WIDTH	LENGTH	PRICE
9BN25	1/4"	96 5/8"	
9BN38	3/8"	96 5/8"	
9BN50	1/2"	96 5/8"	
9BN75	3/4"	96 5/8"	

**BN905**—14" Woodworking Band Saw, as shown with belt and motor pulley less base and motor bracket.

**11BN45**—Base with motor bracket, weight 140 lbs.

**9BN5**—Motor bracket for rear motor mounting (not needed with 11BN4S).

**11BN2**—Belt Guard (used with motor mounted at rear or below).

**9BN81**—Steel ripping fence with guide bar.  
**MG90**—Self-indexing Mitre Gauge.

(For information on other Band Saws see pages 12 and 13)

# WALKER-TURNER MACHINE TOOLS



# TWELVE INCH BAND SAW

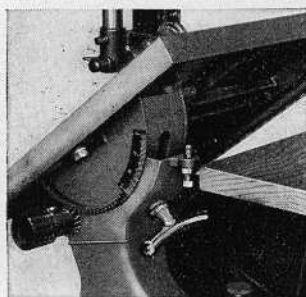
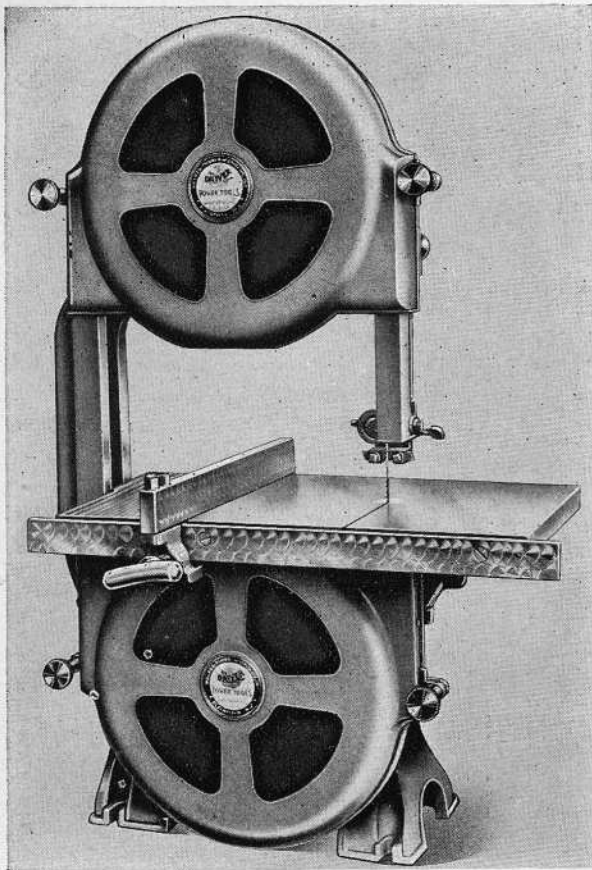

**STURDY TABLE CONSTRUCTION**—Note the sturdy construction of the table and tilting mechanism. Hand wheel at left tilts table while the one at right locks it in position. Adjustable stop screw also shown.

**BN730**—12" Band Saw, as shown including all guards and ripping fence. Belt and motor pulley extra.

**PV25**—2½" V Pulley.

**VB42**—42" V Belt (for use without stand).

**VB44**—44" V Belt (used with stand).

**107**—Steel Stand. (21" long x 11¼" wide x 24¾" high).

**EL5**—Flexo Lamp.

(Motor recommended ½ H.P., 1740 R.P.M.)

(For information on other Band Saws see pages 12, 13, 34, 35)

**1-piece cast-iron cored frame—greater strength, rigidity.**

**Heavy pressed steel 12" wheels carefully balanced, running on oversize ball bearings enclosed in dust-proof housings.**

**Blade guides have ball thrust bearings and oil-impregnated bronze blocks.**

**Highly efficient blade tensioning and wheel aligning device.**

**Cast-iron table, carefully machined, tilts to 45°.**

**Hardwood table extension increases width of table to 18".**

The smooth, powerful action of the 12" band saw has won for it a position of unusual popularity not only in the home workshop but in commercial plants as well. Its fine cutting qualities are apparent in all kinds of work, whether it is cutting sharp corners in light stock or hogging its way through a 4" walnut butt.

Guards, ripping guide and table extensions are regular equipment making this the most completely equipped band saw built. Compare this band saw to any other 12" model on the market. Only then can you realize how superior it actually is . . . how much extra value is built into it.

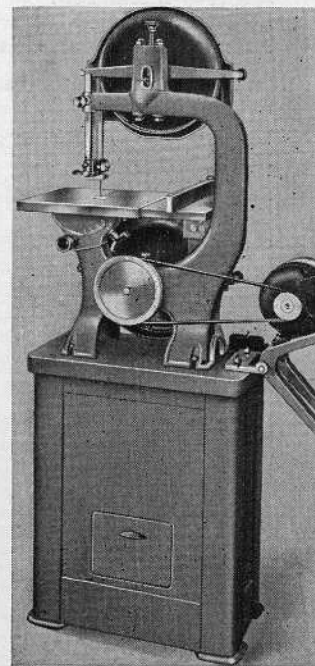

**NEW STEEL STAND**—Cabinet type, fully enclosed. Made of heavy gauge steel. Ideal mounting for 12" band saw, placing the band saw table at the correct working height. With this stand the AD17 hinged motor bracket is used.

**107**—Stand for 12" band saw. 21" long x 11¼" wide x 24¾" high. Shipping wt. 52 lbs.

**AD17**—Hinged motor bracket.

## SPECIFICATIONS

**WHEELS:** Pressed steel, carefully balanced and rubber faced, 12" diameter.

**BEARINGS:** 2 precision, dust-sealed, ball bearings in each wheel.

**FRAME:** Cast iron of tubular construction, accurately machined.

**TABLE:** 12½" x 12", with wood extension 18" x 12" . . . tilts to 45° with geared tilting mechanism. Has soft metal insert around blade to protect it in case of accidental interference with table.

**CAPACITY:** Upper guide to table 6", blade to frame 12". Removing

small guard between upper and lower wheel guards increases capacity above 12".

**GUIDES:** Ball-bearing upper and lower. Guide pins of oil-impregnated bronze relieve friction and add to life of blade.

**RIP FENCE:** Solid steel, has sturdy bracket and solid steel guide bar.

**GUARDS:** Complete set supplied. Wheel guards are detachable separately.

**HEIGHT:** Overall 33½".

**SHIPPING WEIGHT:** 115 lbs.

WOODWORKING BLADES FOR 12" BAND SAW			
CAT. NO.	WIDTH	LENGTH	PRICE
7BN17	⅜"	78"	
7BN20	¼"	78"	
7BN19	⅝"	78"	

METAL CUTTING BLADES FOR 12" BAND SAW				
CAT. NO.	LENGTH	WIDTH	TEETH PER IN.	PRICE
7BN21	78"	¼"	14	
JM51A	78"	½"	8	

**BAND  
SAWS**

**WALKER-TURNER MACHINE TOOLS**

# 8-INCH BENCH SAW

Unusual depth of cut: 2 1/4" with 8" blade.

New all steel rip fence may be used on either side of saw blade.

Ground cast-iron table, 19"x15", tilts to 45°.

Heavy saw arbor runs on oversize dust-sealed precision ball bearings.

Fully enclosed worm gear mechanism raises and lowers saw arbor.

Safety guard and splitter available.

Self-indexing mitre gauge and steel rip fence standard equipment.

Table has soft metal insert removable for dadoing.

In the "Series 700" saw strength, simplicity and convenience of operation have been developed to an almost unbelievable degree. Every one of its unique features contributes in a very definite way to sustained accuracy, utility and safety. Its exceptional depth of cut and table area are indications of its extra value.

The improved B745 saw has 8 1/2" of table space in front of blade. This feature, combined with the overall table size, puts this machine in a class by itself. Steel rip fence supplied in place of wood-faced fence shown.

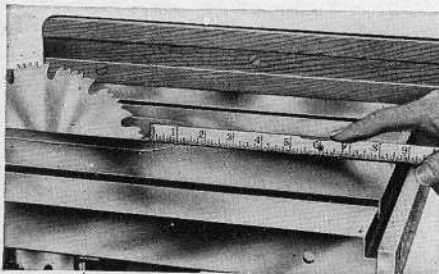

The worm gear raising and lowering mechanism, shown in the phantom illustration below, is an exclusive Walker-Turner development. Gears are housed to protect them from dust and dirt and a hand screw locks gear at any position.

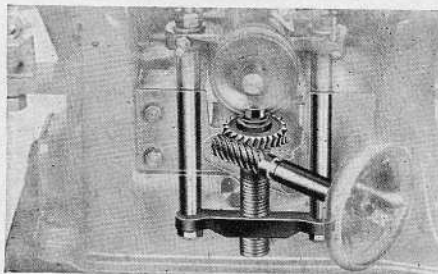

## SPECIFICATIONS

**TABLE:** Close grained gray iron, top ground smooth and heavily ribbed. Tilts to 45°, a scale indicating the degree of tilt. Table insert quickly removable for dadoing.

**SIDE EXTENSIONS:** For table with long guide bar available as an accessory.

**TABLE SIZE:** Without extensions, 19" x 15" . . . with extensions 19" x 31".

**RIP FENCE:** Heavy gauge steel, may be used on either side of blade.

**BEARINGS:** Large, deep groove, precision ball bearings, dust sealed.

**ARBOR:** Raised or lowered by enclosed worm gear.

**GUARD:** Light weight metal affording full protection.

**SPLITTER:** Holds guard in place and spreads saw kerf slightly to minimize binding.

**BASE:** Heavy cast-iron carefully machined. Has sawdust chute.

**MITRE GAUGE:** Geared self-indexing type.

**BLADE:** Combination 8" diameter blade with 5/8" hole.

**CAPACITY:** Cuts full 2 1/4".

**CUT-OFF WHEELS:** For cutting metal and ceramics, available as accessories.

**MOTORS RECOMMENDED:** For light work 1/3 H.P. 1740 R.P.M. (use 4" pulley), for heavy work 1/2 H.P. 3400 R.P.M. (use 2 1/2" pulley).

**SHIPPING WEIGHT:** 100 lbs.

U. S. Pat. No. 2,010,882

The new heavy gauge steel base, with the AD17 motor bracket, provides the ideal mounting arrangement for the B745 saw. Steel rip fence supplied in place of wood-faced fence shown.

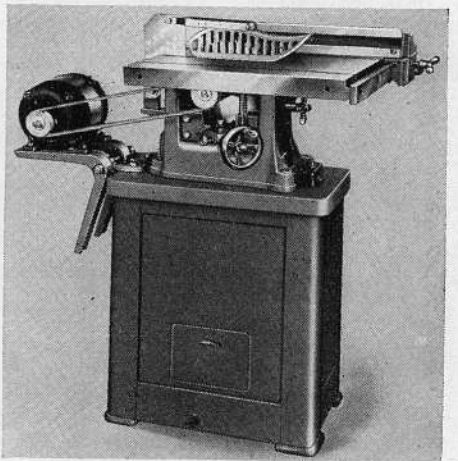

**B745—8" Bench Saw** as shown with steel rip fence, self-indexing mitre gauge and combination blade, but less table extensions, guard and splitter (motor pulley and belt not included).

**PV450—4" V Pulley.**

**VB39—39" V Belt.**

**AD17—Motor Bracket.**

**57—Guard and Splitter.**

**107—Steel Stand** (21" long x 11 1/4" wide x 24 3/4" high).

**7B31—Side table extensions**, with long guide bar (pair).

**7B5—Table insert** for dadoing.

**11BN7—Front extension table** (14" x 10") with fence.

See page 39 for listings of saw blades and dados.

# WALKER-TURNER MACHINE TOOLS

**BENCH  
SAWS**

# GEARED MOTOR FLOOR MODEL TILTING ARBOR SAW



10" MODEL

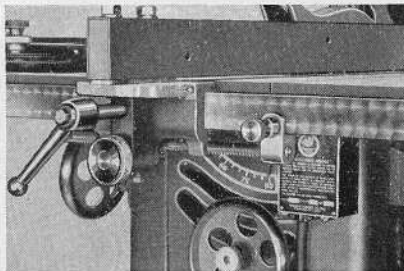

Several exclusive features are shown above. The magnetic switch that protects the motor from overloading; the Vernier adjustment of the ripping fence; the convenient fence locking lever that releases or locks the fence in less than a half turn; the raising and lowering control wheel and the long steel ripping fence . . . all afford greater utility and convenience.

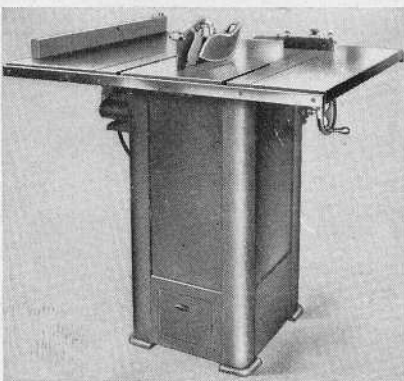

A clean-out door in lower rear section of base facilitates the removal of sawdust. Also note the extra table area between saw splitter and rear edge of table top.

U. S. Pat. No.  
2,010,882  
Other Patents Pending

**TA1180**—Floor model tilting arbor saw (geared motor drive) as shown less geared motor and switch, extension tables, guard and splitter.

**GB10** — 1 H.P., 110-220 volt, 60 cycles, AC, geared motor with magnetic circuit breaker switch and air filter.

**TA1180B** — (Same as TA1180 but with Texrope Drive).

**KEB10S**—1 H.P., 110-220 volt, 60 cycles, AC motor with circuit breaker, less air filter for TA1180B.

3 Phase Motors Also Available.

**11TA33**—Extension tables, three, one 32" x 15", one 32" x 8 3/4" for sides and one extension for front or rear of main table 20" x 5".

**TA15** — Guard, splitter and anti-kick-back pawls.

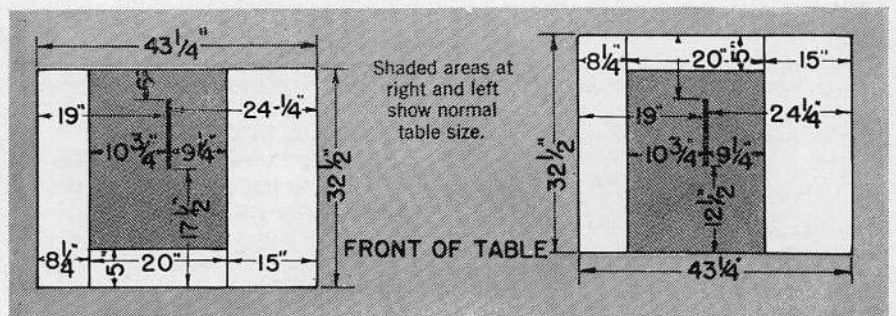

**ARBOR  
SAWS**

**WALKER-TURNER MACHINE TOOLS**

**GEARED  
MOTOR**

# FLOOR MODEL TILTING ARBOR SAW

Air-filtered, geared-power motor with over 300% pull out torque. Allis-Chalmers Texrope Drive also available.

Magnetic overload protection switch positively eliminates injury to motor due to overloading.

Heavy cast iron and steel tilting assembly . . . perfectly balanced and designed so it cannot be sprung or twisted out of alignment.

Tilting and raising mechanisms are operated easily.

Simple, strong gun-type elevating mechanism. *Cannot be jammed!*

Heavy welded steel base, fully enclosed. Clean-out door at rear.

Vernier adjustment of ripping fence regular equipment.

Ample provision for take-up due to wear. Positive locks do not throw any strain on mechanism.

The entire operating mechanism is attached to the underside of table to eliminate the possibility of misalignment.

Anti-kick-back guard and splitter is a definite safety factor.

A ripping fence of new design is locked or unlocked on guide bar by less than a half turn of the control lever.

Self-indexing mitre gauge regular equipment.

## AIR-FILTERED, GEARED, SHOCK-PROOF MOTOR

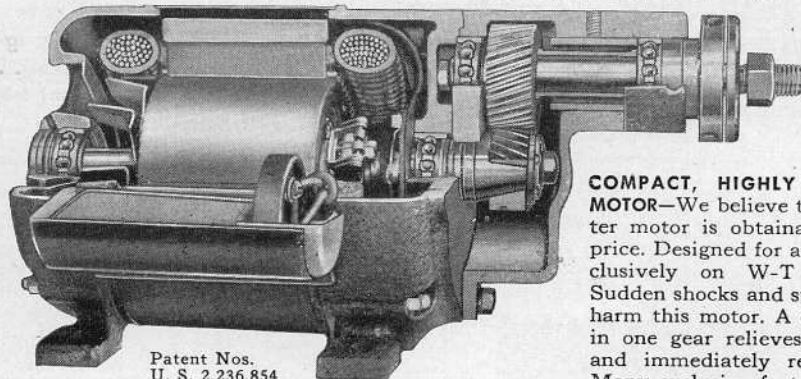

Patent Nos.  
U. S. 2,236,854  
Great Britain 527,508  
Canada 391,285

annealed after punching. Copper-wound rotors have end rings brazed with silver alloy. Positive, quick-acting starting switch. All electric connections welded, not soldered.

Guaranteed to have a pull-out torque of over 300%. This means that the 1 H.P. motor actually delivers approximately 3 H.P. before stalling. Cool in operation—temperature rise not to exceed 40° C.

All W-T 1 H.P. single phase, geared motors intended for saw operation have a filter attached to the air intake end bell.

### COMPACT, HIGHLY EFFICIENT MOTOR

We believe that no better motor is obtainable at any price. Designed for and used exclusively on W-T machines. Sudden shocks and stalls cannot harm this motor. A cone clutch in one gear relieves the strain and immediately resets itself. Many exclusive features are incorporated into its design. High silica steel laminations are an-

## SPECIFICATIONS

**TABLE:** In horizontal position at all times, the arbor tilts. It is made of gray iron heavily ribbed for rigidity with top smoothly ground to a plane surface.  $\frac{3}{4}$ " x  $\frac{3}{8}$ " mitre gauge slots, one on each side of the blade, are accurately milled.

**TABLE SIZE:** Without extensions, 20" x 27"; with set of 3 extensions, 32" x 43". The position of extensions can be varied, see sketch on opposite page. Distance from front of table to 10" blade without extension 13", with extension 18".

**SAW SUPPORTING UNIT:** Consists of two heavy castings carefully machined.

Unit is tilted to 45° through accurate screw actuated by control wheel. A positive lock is provided.

**ELEVATING MECHANISM:** Unique, gun type, works on crank and link principle. Turning the wheel in one direction raises or lowers the saw blade. Mechanism cannot be jammed.

**BALL BEARINGS:** 4 precision, SKF, in geared motor carry motor shaft and saw spindle. Belt drive model has two large ball bearings in arbor.

**MAGNETIC CIRCUIT BREAKER:** This



**CUT OFF WHEELS**—The metal cutting wheel will cut steel sheets, rods and tubes. The one for ceramics will cut tile, brick and so forth.

G110—8" for metal, bore  $\frac{5}{8}$ ".

G111—8" for ceramics,  $\frac{5}{8}$ " bore.



### SAW BLADES

7B15R—8" rip.

9B39R—10" rip.

7B15—8" crosscut.

9B39—10" crosscut.

7B20—8" combination.

9B37—10" combination.

7B8—8" hollow ground.

9B10—10" hollow ground.

Above blades,  $\frac{5}{8}$ " bores.

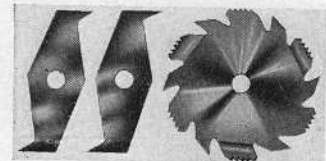

### DADO HEADS

9B36—6" as shown.

Consists of:

2— $\frac{1}{8}$ " chippers.

2— $\frac{1}{8}$ " outside saws.

1— $\frac{1}{8}$ " chipper.

1— $\frac{1}{4}$ " chipper.

D56— $5\frac{1}{2}$ " outside dado, 2 used.

D56A—Inside chipper.

All above dados have  $\frac{5}{8}$ " bores.

switch is regular equipment on single phase geared saw motors of 1 and 2 H.P.

**RIP FENCE:** Welded steel section, 33" long with quick acting control lever. Vernier adjustment is regular equipment.

**NEW TYPE GUARD:** Splitter and anti-kick-back pawls give complete protection.

**CAPACITY:** Depth of cut 3".

**SAW BASE:** Heavy gauge steel of modern design with clean-out door at rear.

**OVERALL HEIGHT:** Table to floor 35".

**SHIPPING WEIGHT:** Approximately 265 lbs. less motor.

# WALKER-TURNER MACHINE TOOLS

**ARBOR  
SAWS**

# PORTABLE TILTING ARBOR SAW

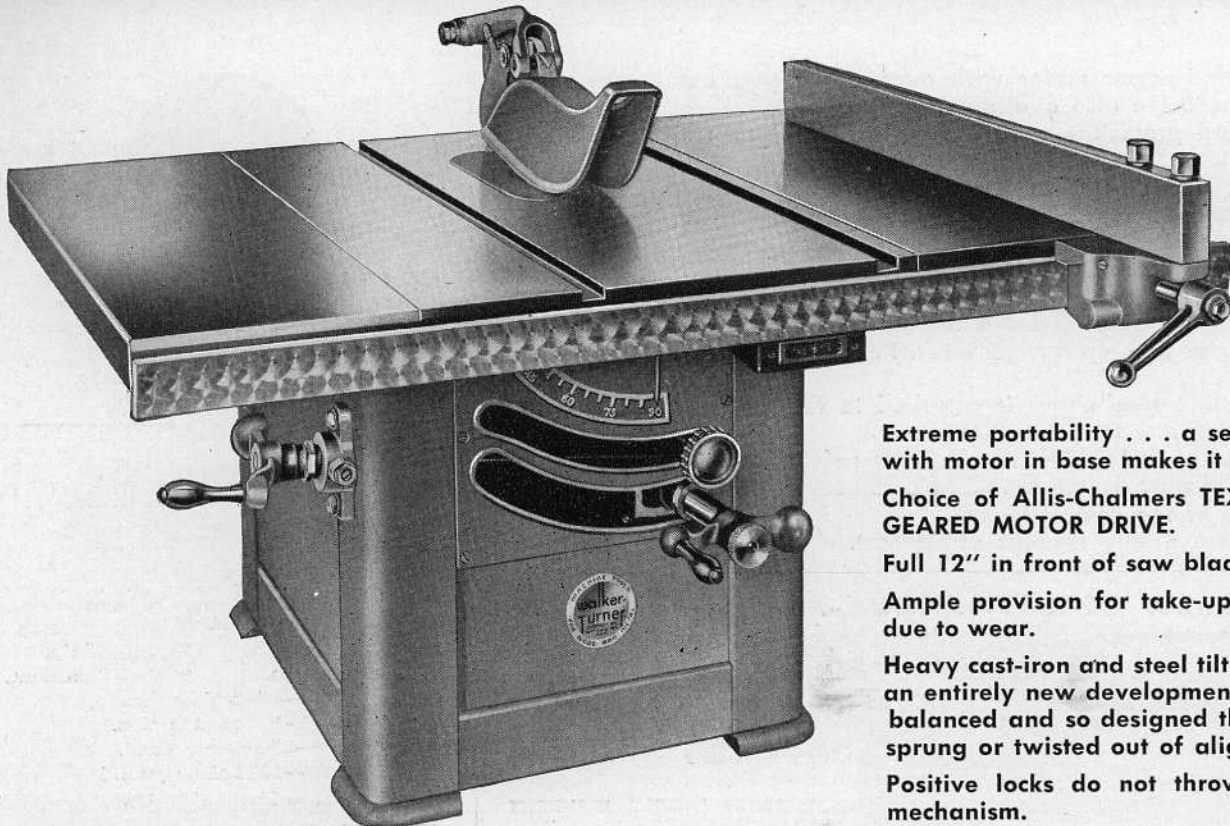

Extreme portability . . . a self-contained unit with motor in base makes it readily portable.

Choice of Allis-Chalmers **TEXROPE DRIVE** or **GEARED MOTOR DRIVE**.

Full 12" in front of saw blades.

Ample provision for take-up and adjustment due to wear.

Heavy cast-iron and steel tilting assembly . . . an entirely new development . . . is perfectly balanced and so designed that it cannot be sprung or twisted out of alignment.

Positive locks do not throw any strain on mechanism.

**TA950—PORTABLE TILTING ARBOR SAW.** Geared Motor Drive, less guard and splitter, table extensions, motor and switch.

**TA950B—PORTABLE TILTING ARBOR SAW,** as shown Texrope Drive model, less guard and splitter, table extensions, motor and switch.

*10" rip blade and mitre gauge included. Motors, accessories, next page. Dados and blades, page 37.*

**19—STAND** for portable tilting arbor saw.



**WELDED STEEL SUB-BASE**—Brings the saw table to a normal working height of 35".

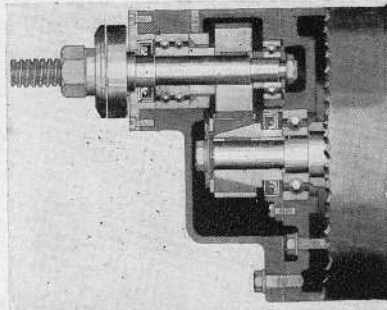

Patent Nos. U. S. 2,236,854; Canada 391,285; Great Britain 52,508.

**GEARED MOTOR DRIVE**—W-T geared motors are the sensation of the woodworking industry. Never before has such a combination of power and efficiency been available. These units provide the most satisfactory drive from the standpoint of efficiency, dependability and freedom from upkeep. A cone clutch built into one of the gears prevents any possibility of stripping. Gears are guaranteed against tooth breakage under all conditions. See page 36 for complete information. Illustration shows the general design of W-T geared motors as used on circular saw applications.

**TEXROPE DRIVE**—The well-known Allis-Chalmers **TEXROPE DRIVE** employing three belts and three-groove pulleys is available for those who prefer a belt drive machine. It operates quietly and smoothly with ample over-load capacity for production work.

Patents Pending

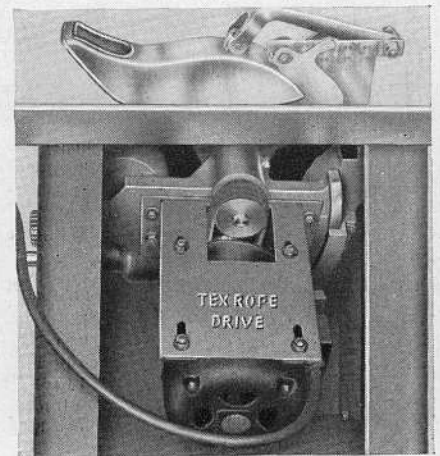

**ARBOR  
SAWS**

## WALKER-TURNER MACHINE TOOLS



# PORTABLE TILTING ARBOR SAW

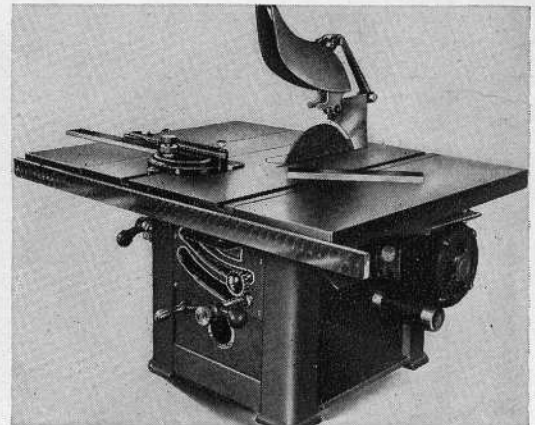
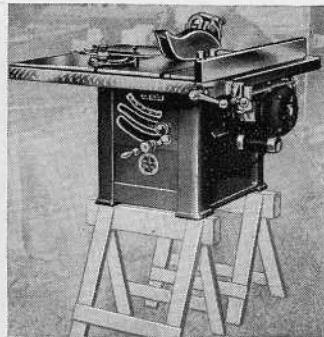
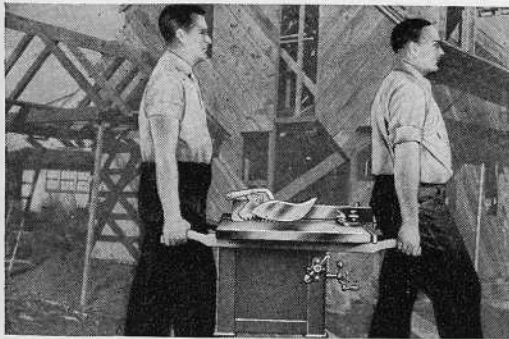

**SELF-CONTAINED PORTABLE**—For the first time builders and contractors are offered a thoroughly practical self-contained saw that is portable,—a saw that has the accuracy and capacity of heavy shop machines yet one that can be transported from job to job. Not only can this machine be readily moved from basement to attic as the job progresses, but it has greater utility than the electric hand saw. It will rip and cross-cut material up to 3" in thickness and dado with or across the grain. Also with a cut-off-wheel it cuts metal moldings, wrought iron pieces and other metallic materials used in building.

New gun type elevating mechanism is simple and strong. Turning the control crank in one direction raises as well as lowers the arbor. Cannot jam! Saw spindles on both **TEXROPE** and **GEAR DRIVE** models are unusually large and turn on heavy duty precision ball bearings.

The entire operating mechanism is attached to the underside of the table eliminating the possibility of misalignment between table and blade.

The new kick-back guard and splitter is a definite safety factor.

A ripping fence of new design is locked or unlocked on guide bar by less than a half-turn of the control lever.

Automatic self-indexing mitre gauge included as regular equipment.

Heavy welded steel base fully encloses and protects complete mechanism.

Provision is made for bolting to bench or sub-stand.

Table extensions available at extra cost.

## SPECIFICATIONS

**TABLE:** In horizontal position at all times, the arbor tilts. Table is gray iron heavily ribbed for rigidity with top smoothly ground to a plane surface. Mitre gauge slots, one on each side of blade, are accurately milled.

**TABLE SIZE:** Without extensions 25" x 16"; with extensions 25" x 32".

**CAPACITY:** Depth of cut with 10" blade over 3" . . . with 8" blade over 2" . . . distance front of table to 10" blade, 12"; distance front of table to 8" blade, 13".

**DRIVE:** Multiple V belt (Texrope) or geared motor drive optional at slightly different cost.

**SAW SUPPORTING UNIT:** Consists of two heavy castings carefully machined. Trunnion type suspension is used for attaching unit to table. Unit is tilted to 45° through accurate screw actuated by ball crank. A positive lock is provided.

**ELEVATING MECHANISM:** Unique, gun type, works on crank and link principle. Turning the ball crank in one direction raises and lowers the blade. Mechanism cannot be jammed.

**BALL BEARINGS:** 4 precision, SKF's in motor unit carry motor shaft and drive spindle. Belt drive model has two large ball bearings in arbor.

**RIP FENCE:** Welded steel section, 26" long with quick-acting control lever. Less than a half turn releases or locks the fence.

**NEW TYPE GUARD:** This guard, with splitter and anti-kick-back pawls gives complete protection.

**SUB-BASE:** Of heavy gauge steel converts these models into floor models. Available as an extra.

**HEIGHT:** Overall without sub-base 18", with sub-base 35".

**SHIPPING WEIGHT:** Approximately 195 lbs. less motor.

**ADAPTABLE FOR METAL CUTTING**—By substituting an abrasive cut-off wheel for the saw blade it is possible to cut ferrous and non-ferrous metal and various compositions. For accessories see page 37.

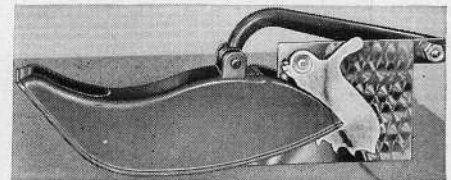

**NEW GUARD AND SPLITTER**—Keeps blade covered at all positions with minimum interference. Splitter spreads saw kerf slightly, reducing binding. Anti-kick-back pawls rest lightly on stock and effectively prevent its being projected back toward operator. TA15—Guard and Splitter.

## MOTORS

\*KEB55—1/2 H.P., 110-220 volts, AC, 60 cycle motor with standard switch, used with 8" blade on TA950B.

\*KEB105—1 H.P., 110-220 volts, AC, 60 cycle motor with circuit breaker switch, less air filter, used with 10" blade on TA950B.

3VB16—Set of 3 Texrope belts.

GB5—1/2 H.P., 110-220 volts, AC, 60 cycles, geared motor with switch, used with 8" blade on TA950.

GB10—1 H.P., 110-220 volts, AC, 60 cycle, geared motor circuit breaker switch, air filter for 10" blade on TA950.

AF5—Air filter for motors other than GB10.

MB55—Circuit breaker switch, specify horsepower and type motor.

\* Because condenser is mounted on the top, one of these motors must be used on TA950B.

## EXTENSION TABLES

Heavy gauge steel extension tables, 8" wide and 25" long increase the table width to 32".

9TA22—Side Extension tables (with long guide bar).

11BN7—Front Extension table (14" x 10") with fence.

# WALKER-TURNER MACHINE TOOLS

**ARBOR  
SAWS**

# 6" JOINTER—TEXROPE MODEL

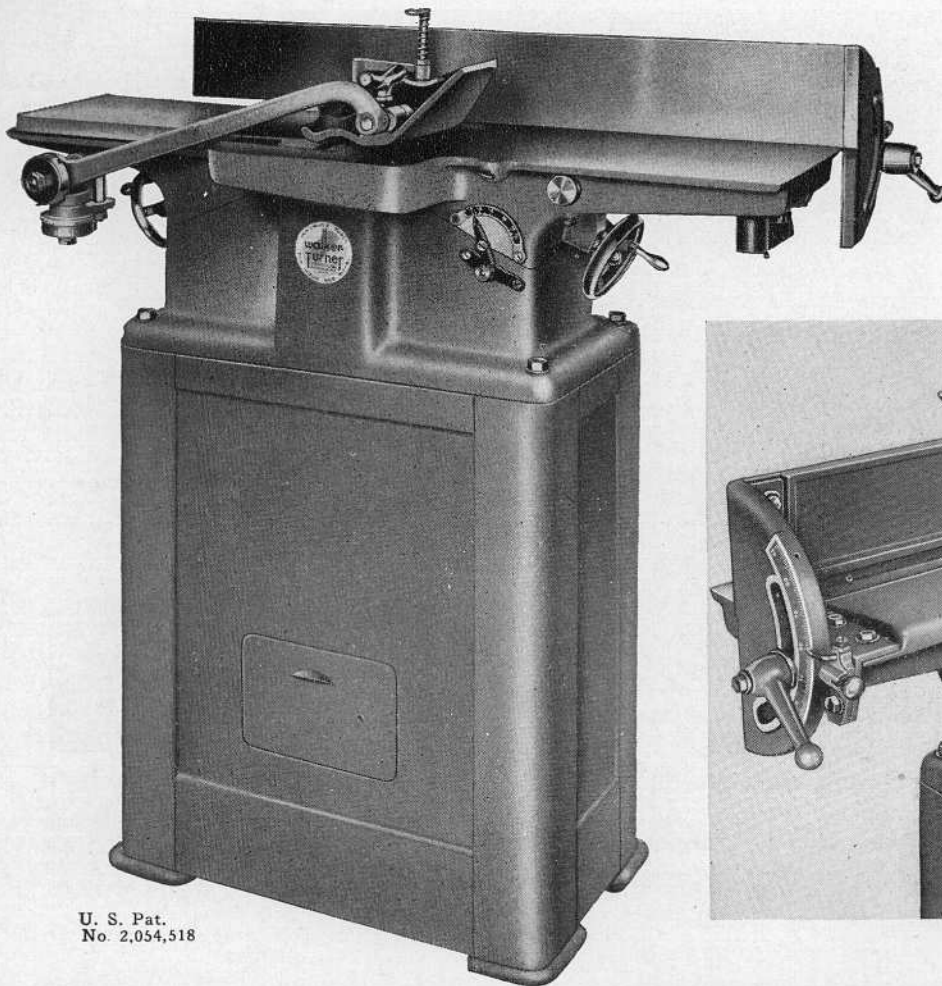

U. S. Pat.  
No. 2,054,518

**COMPACT SELF-CONTAINED UNIT**—The view (right, above) shows the new hinged fence, quick-action fence locking lever, motor mounting, Texrope multiple V belt Drive, rear knife guard that keeps the knives covered when rabbeting and the conveniently located motor switch. Every detail of construction contributes to its sturdiness, accuracy and efficiency.

## TEXROPE MODEL

**P910**—6" Jointer De Luxe equipment, as shown above, with **MULTIPLE V BELT (TEXROPE) DRIVE** motor base and dual-purpose guard, less motor switch and machine base.

**9P46**—Knife guard for rear of fence.

**107A**—Steel stand with chute.

**KEB55**— $\frac{1}{2}$  H.P., 110-220 volts, 60 cycles, AC, 3450 R.P.M. capacitor motor.

Unit construction with motor attached to jointer base on Texrope model makes for extreme compactness and ready portability.

Texrope drive with triple V belts permits highly efficient, close-coupled motor connection on P910.

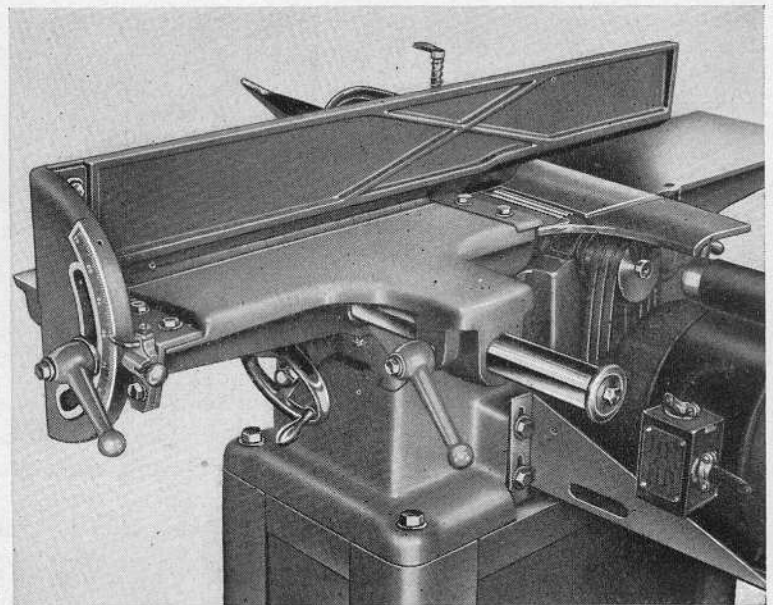

**DUAL PURPOSE GUARD AN EXCLUSIVE FEATURE**—On ordinary jointers the guard simply swings over the knives for protection, but the guard on this jointer performs a double function. It has been so designed that the work may be fed under it while the operator's left hand, resting on the guard applies the necessary amount of pressure. This permits planing wood down to ribbon thickness, with absolute safety. Also, thin narrow strips may be planed down to practically nothing by feeding the strip between the fence and the curved, inner edge of the guard. **PLANES RIBBON THIN!**—Notice in the photo that the work is being fed *under* the dual purpose guard. In this way stock can be reduced to uniform ribbon-thinness with absolute safety. No other jointer has this patented Walker-Turner feature that is endorsed by insurance companies and schools. **HANDLES SMALL STRIPS**—Pressure of the thumb on the plunger holds the piece down while the guard itself holds the piece.

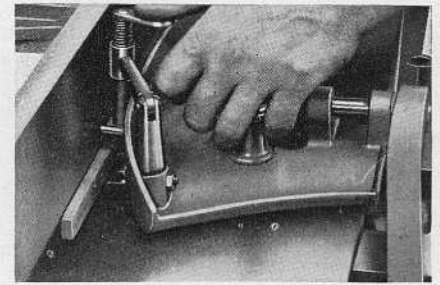
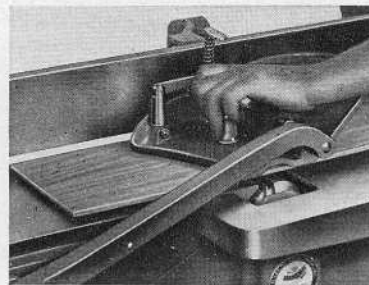

JOINTERS

WALKER-TURNER MACHINE TOOLS

# 6" JOINTER—STANDARD MODEL

New hinged fence with quick-action release lever. Positive, convenient, accurate.

Heavy, accurately machined tables mounted on dovetail ways with adjustable gibs.

Conveniently located motor switch included with motor.

Heavy gauge welded steel base with sawdust chute available.

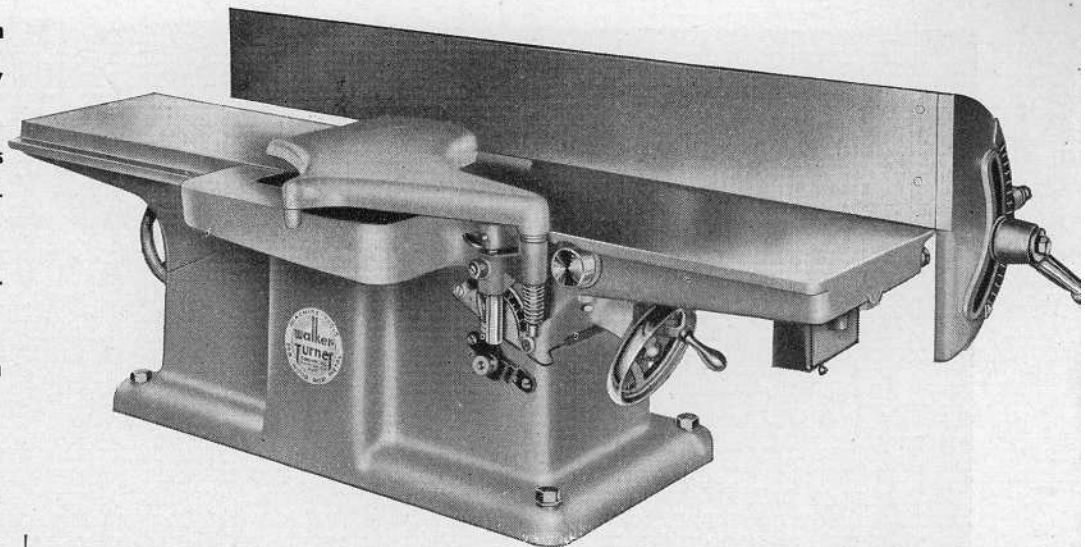

In addition to the De Luxe Model, P910, the standard model illustrated above is offered. The machines are identical except for the drive and guard. Both fit 107A stand but when the standard model is mounted on the stand the AD17 motor bracket, page 49, is attached to rear of stand.

**NEW QUICK-ACTION LOCK**—Less than a half turn of the locking lever locks or releases the fence. Note the readily visible graduated scale and the automatic plunger for locating most-used angles of tilt. Every factor for maximum convenience has been included.

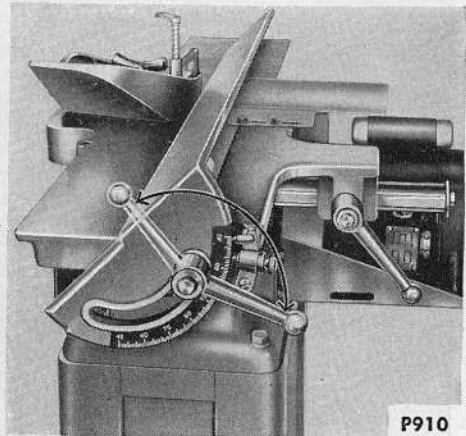

## SPECIFICATIONS

**TABLES:** Heavy gray iron cored castings with tops carefully ground. Bottoms have machined dovetail ways to match base. Gibs provided for adjustment.

**BASE:** Sturdy casting accurately machined. Drilled and tapped for motor base on P910.

**CUTTERHEAD:** Solid steel carefully machined and balanced. Three-knife, approved round type, 2½" in diameter.

**BEARINGS:** Precision dust-sealed ball bearings.

**KNIVES:** Made of selected steel honed to fine edge. Each knife held in position by four jack-screws and provided with a chip breaker.

**GUARD:** Patented Dual Purpose Guard on P910; conventional type guard on P908.

**DEPTH INDICATOR:** Accurately shows depth of cut in fractions of an inch.

**FENCE:** Made of malleable iron, ground

and polished, 29½" long, 4¼" high. Indicator shows position in relation to table. Stops provided at 45° and 90° positions. Movable laterally across full width of the table for rabbeting. Control lever locks or releases in less than a half turn. Plunger locates fence at principal positions.

**DRIVE:** P910 has Allis-Chalmers multiple belt Texrope; P908 has single belt and pulley drive.

**RABBETING CAPACITY:** Up to ½".

**OPERATING SPEED:** P910 4200 R.P.M., P908 5000 R.P.M. with 3450 R.P.M. motor.

**LENGTH:** Overall 37½", front table 17½", rear 15¼".

**HEIGHT:** From floor to jointer table top 34", machine only 9½".

**SHIPPING WEIGHT:** P908 approximately 160 lbs.; P910 approximately 175 lbs. without stand or motor. Stand approximately 55 lbs.

## STANDARD MODEL

**P908**—6" Jointer, as shown above with conventional knife guard, less belt, motor pulley and switch.

**PV450**—4" pulley, used with 3450 R.P.M. motor.

**VB42**—42" V-belt, used with 3450 R.P.M. motor.

**9P46**—Knife guard for rear of fence.

**KEB5**—½" H.P., 110-220 volts, 60 cycle, AC, 3450 R.P.M. capacitor motor (with remote control switch).

**KEB3**—⅓ H.P., 110-220 volts, 60 cycle, AC, 3450 R.P.M. capacitor motor (with remote control switch).

**9P9**—Set of three knives (for replacement).

# WALKER-TURNER MACHINE TOOLS

## JOINTERS

# 1100 SERIES VARIABLE SPEED LATHE

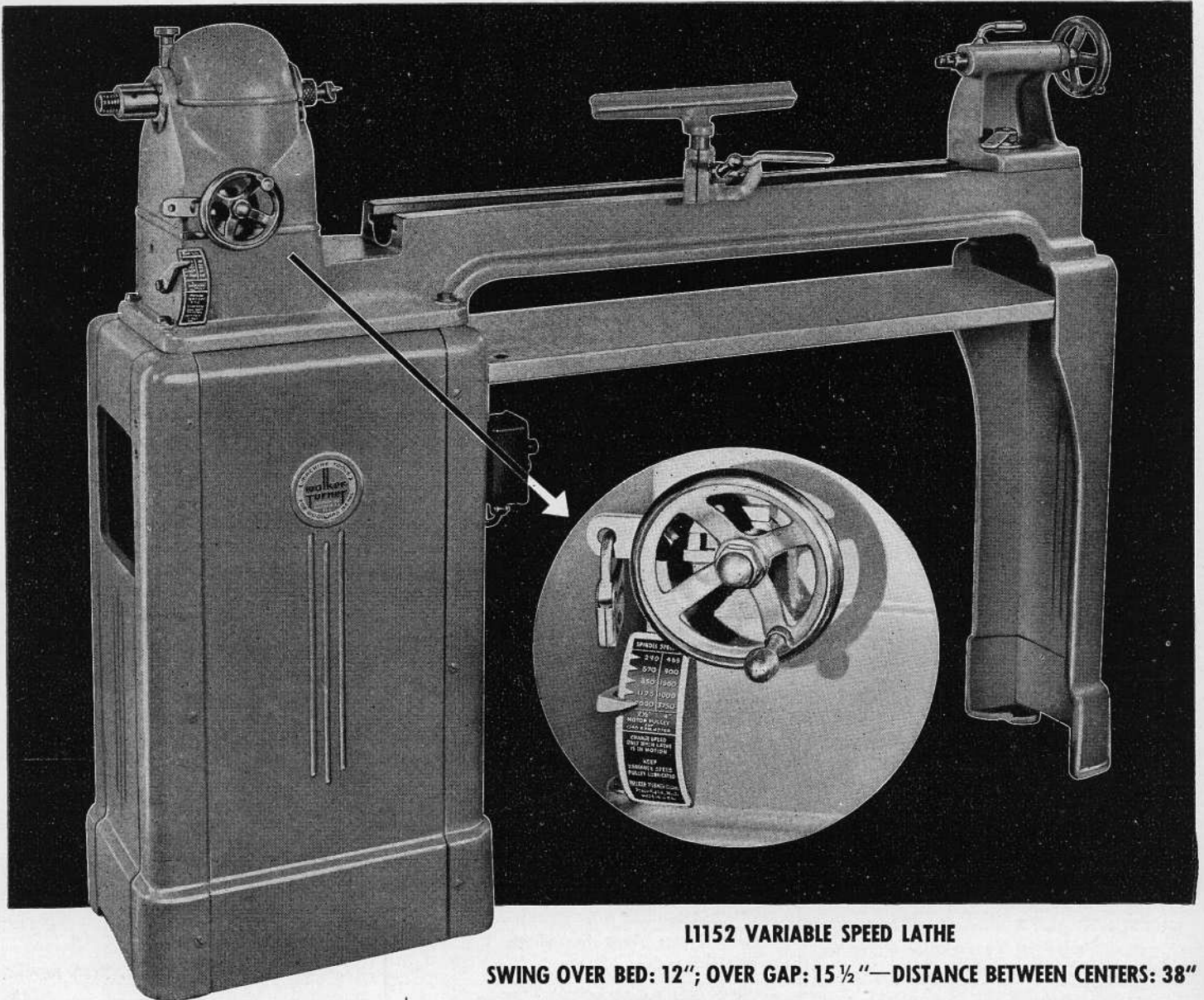

**L1152 VARIABLE SPEED LATHE**

**SWING OVER BED: 12"; OVER GAP: 15 1/2"—DISTANCE BETWEEN CENTERS: 38"**

This rugged, safe, extra capacity lathe is built with a variable speed drive as an integral part of the headstock. This drive provides any speed from 260 R.P.M. to 4200 R.P.M., depending upon motor and motor pulley used.

Spindle speeds are controlled by a hand wheel (as illustrated) and are indicated on a scale. A feature of special importance to manual training instructors is that the spindle speed may be set and the control locked in position. Speed cannot be changed without unlocking the control.

Bed ways are machined on top, sides and bottom (left) for accuracy and ease of operation. The tailstock center is automatically ejected. Several types of centers including ball bearings are available (see pages 46 and 47). A new, smooth acting tool rest with permanently mounted clamping wrench is provided.

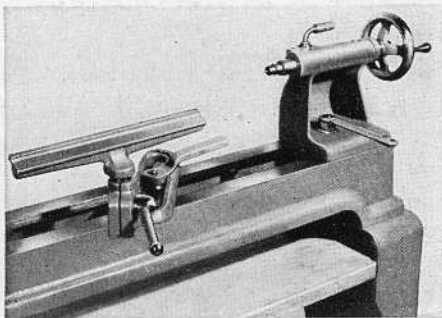

**W-T  
LATHES**

# WALKER-TURNER MACHINE TOOLS

# 900 SERIES FOUR-SPEED LATHE

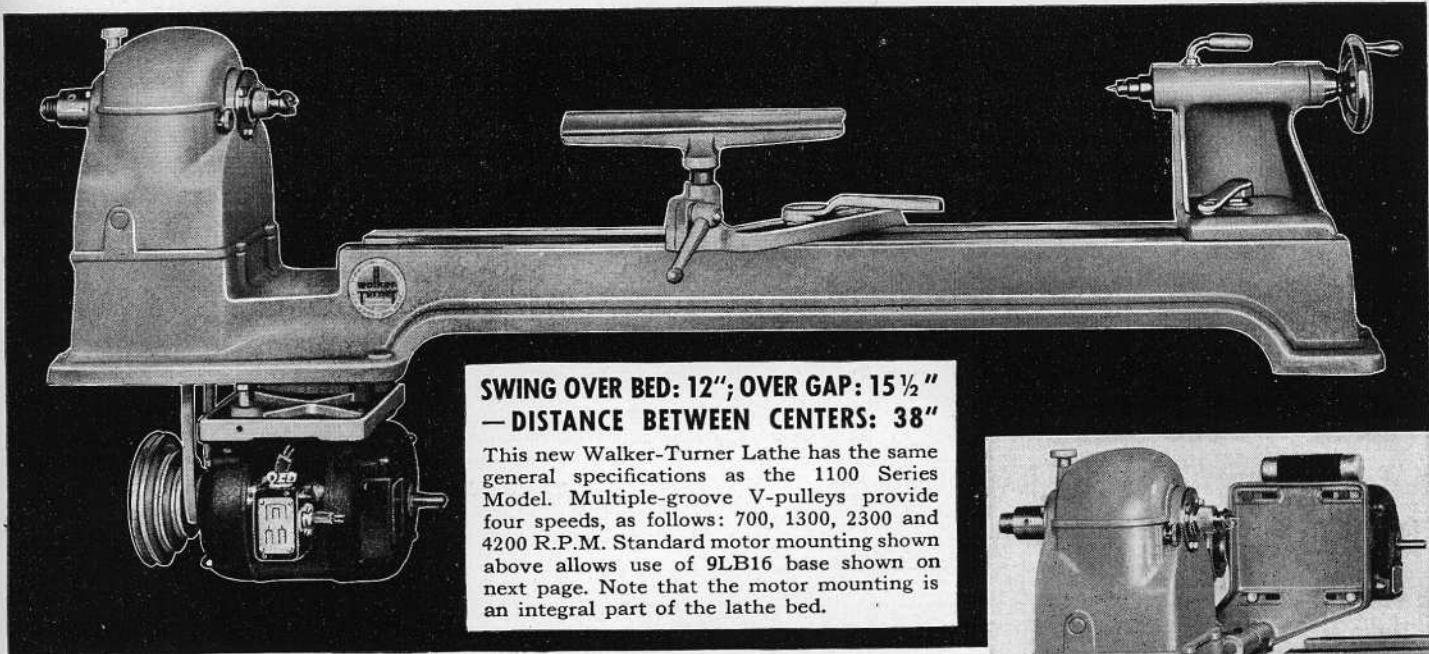

**SWING OVER BED: 12"; OVER GAP: 15 1/2"  
— DISTANCE BETWEEN CENTERS: 38"**

This new Walker-Turner Lathe has the same general specifications as the 1100 Series Model. Multiple-groove V-pulleys provide four speeds, as follows: 700, 1300, 2300 and 4200 R.P.M. Standard motor mounting shown above allows use of 9LB16 base shown on next page. Note that the motor mounting is an integral part of the lathe bed.

## TWO LATHES DESIGNED FOR ALL REQUIREMENTS

Headstocks have two sets of pre-loaded precision ball bearings with deep groove races (double row at right end of spindle, single row at left).

Ample overload capacity for both thrust and radial loads is provided.

Headstock spindle, which is hollow, is one inch in diameter between bearings.

All head and tail stock centers have No. 2 Morse Tapers.

Extra strength and rigidity built into these lathes make them ideal for metal turning and spinning.

Gap bed construction provides 3 1/2" of extra capacity without sacrifice of sturdiness or convenience.

Headstock spindle run-out accuracy held well within all commercial and industrial tolerances.

Special cast-iron base (standard on L-1152 lathe only) encloses motor, protecting it from chips and dust produced by operation of the lathe.

Adjustable tool rest bracket of new design provides smooth, quick action. Permanently mounted clamping wrench assures quick changes and positive locking. Spindle threaded for outboard mounting of face plate.

## SPECIFICATIONS • BOTH MODELS

**OVERALL DIMENSIONS:** Height: 47"; Width: 11 1/2"; Length: 58".

**SWING:** Over gap 15 1/2"; over bed 12".

**DISTANCE:** Between centers 38"; bed to floor 36".

**No. 2 MORSE TAPER CENTERS.**

**HEAD STOCK SPINDLE:** 1" O. D. 5/8" hole thru its length threaded R. & L. H. 12 threads to the inch.

**S. K. F. BALL BEARINGS:** Preloaded; Double Row at Spindle Nose.

**INDEXING PLUNGER:** Positive Type on pulley.

**2 MACHINED WAYS** on bed 1 3/8" wide.

**WIDTH OF BED:** Across ways 5".

**HEAD-STOCK, TAIL-STOCK, BED AND TOOL REST:** Machined gray iron castings.

### MOTOR DATA

For average turning, Model SAB3 (1/3 H.P.—1740 R.P.M.) motor is recommended. If, however, a large amount of face plate work or metal spinning is to be done Model LKAB5S (1/2 H. P.—1740 R.P.M.) motor should be used. **SPECIAL NOTE:** Where 3 phase current is available, a

2-speed motor Model LPAEB5 1/2 H.P., 1750/3500 R.P.M., 60 cycle, can be used. This motor greatly increases the speed range of the 1100 Series lathe, providing any speed from 260 R.P.M. to 4500 R.P.M. This motor should not be used on the 900 Series Lathe.

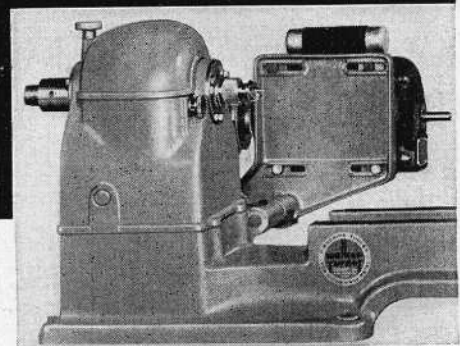

**FOR MOUNTING MOTOR AT REAR**—By use of the special bracket SL51 illustrated above and VB39, 39" V-belt, the motor can be mounted at rear. To order, specify L951 Four Speed Lathe and SL51 Special Bracket.

**L1152—VARIABLE SPEED LATHE** as shown on page 44, including variable speed drive, base 12" and 6" tool rests, without motor.

**L952—FOUR-SPEED LATHE** as shown above, including 44" V-Belt, 12" and 6" tool rests and motor mounting, without motor and motor pulley.

**L951—FOUR SPEED LATHE** with 39" V-belt for rear motor mounting, less motor, motor pulley and rear mounting bracket.

**PV62—5 1/2"** 4-step pulley (for 5/8" motor shaft) fits SAB3 Motor.

**PV500—5 1/2"** 4-step pulley (for 1/2" motor shaft).

**9LB16**—Bench for L952 Lathe.

**SAB3**—Motor (1/3 H.P., 1740 R.P.M., 110 V., 60 cycle, A.C.) for L951 and L952 only.

**LKAB5S**—Motor (1/2 H.P., 1740 R.P.M., 110/220 V., 60 cycle, AC single shaft for L1152 Lathe) only.

**LPAEB5**—Motor (For L1152 Lathe only) 1/2 H.P., 1750 and 3500 R.P.M., 60 cycle, three-phase.

**SL51**—Motor Bracket for rear mounting of motor on L951 Lathe.

# WALKER-TURNER MACHINE TOOLS

W-T  
LATHES

# LATHE ACCESSORIES FOR

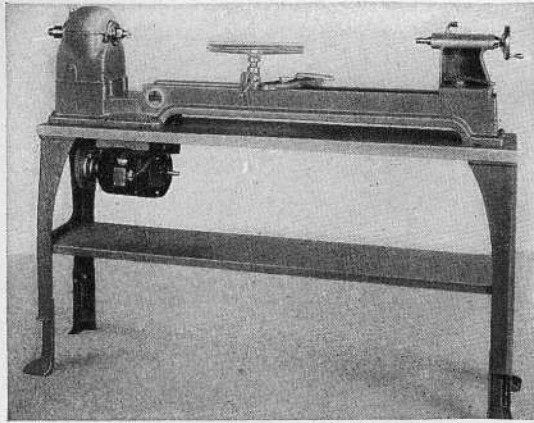

**STURDY LATHE BENCH**—Developed especially for Series "900" lathes. Height can be varied several inches by means of adjustable legs. Necessary bolts supplied. Heavy cast-iron legs. 57" long, 11½" wide. Shipping weight complete, 79 lbs.

9L16—Lathe bench complete.

BL1—Bench legs only (for bench shown at left).

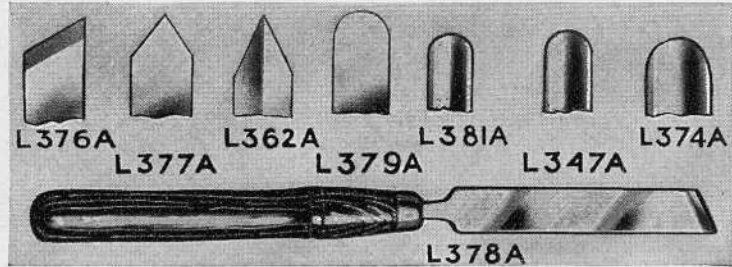

**WOODTURNING TOOLS**—Full size, blades of selected steel; hard-wood handles have a natural, perfect grip. Wide selection of types covers all normal turning requirements.

L378A—1" Skew Chisel.  
L376A—½" Skew Chisel.  
L379A—½" Round Nose.

L362A—½" Parting Tool.  
L374A—¾" Gouge Chisel.  
L347A—½" Gouge Chisel.

L381A—¼" Gouge Chisel.  
L377A—½" Spear Point.  
L8A—Set of eight (as above).

**HAND-FORGED CHISELS**—Hand-forged and hand-ground, these chisels hold a fine cutting edge much longer—require less sharpening and last longer than ordinary chisels.

CH21—1" Skew Chisel.  
CH22—½" Skew Chisel.  
CH26—½" Parting Tool.  
CH23—¾" Gouge Chisel.  
CH24—½" Gouge Chisel.  
CH25—¼" Gouge Chisel.  
CH27—½" Round Nose.  
CH28—½" Spear Point.  
CH29—Set of 8 Hand-forged chisels (as above).

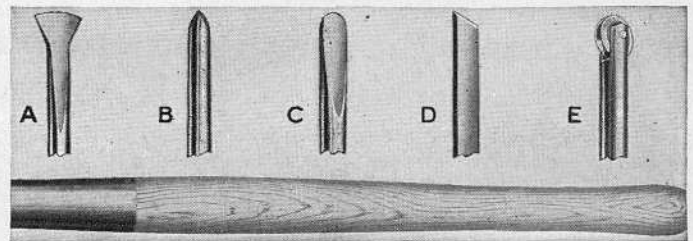

**METAL SPINNING TOOLS**—These spinning tools represent the types most commonly used and fill all the requirements for ordinary work. Handles are hard-wood 20½" long.

B—MS5—No. 1 Point tool  
A—MS4—No. 1 Flat tool  
C—MS6—No. 2 Flat tool

D—MS7—Cut off tool  
E—MS8—Beading tool  
(Each of above with handle)

## SPECIAL ACCESSORIES FOR METAL SPINNING

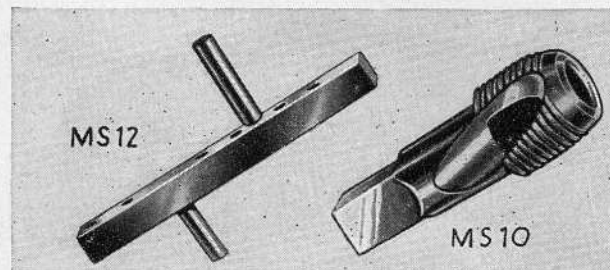

**TOOL REST**—A special, heavy tool rest with movable pin and a row of holes in the top is needed in spinning. Fits into the Series "900" and "1100" lathe bed brackets.

MS12—Special Tool Rest.

**12-THREAD TAP**—A 1", 12-thread tap is helpful for threading wood forms to fit the lathe spindle.

MS10—1", 12 Tap.

**BALL BEARING CENTER** (Illustrated on next page)—Fits "900" and "1100" lathes, taking the place of the regular tail center. 60° and cup centers.

MS9—Tail Center.

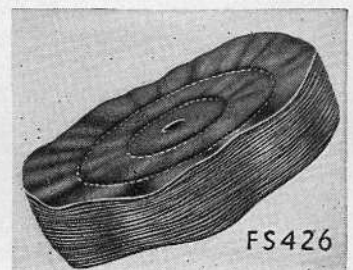

**COTTON BUFFER**—After work is spun to shape it needs to be buffed and polished to get out tool marks. ½" hole.

FS426—6" Buffer. 931—3" Buffer

**BUFFING COMPOUND**—Buffing compound, used with the cloth wheels, increases cutting speed.

940—Buffing compound.

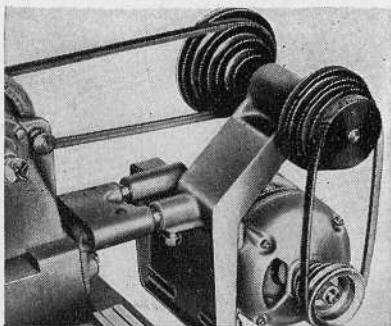

**9L50—16 SPEED BRACKET**—Attaches directly to lathe bed. Includes all necessary belts and pulleys. Speeds, 240, 360, 440, 510, 660, 710, 760, 930, 1150, 1,000, 1400, 1670, 2040, 2260, 2950, and 4000 R.P.M. with 1740 R.P.M. motor. (Fits L951 Lathe only.)

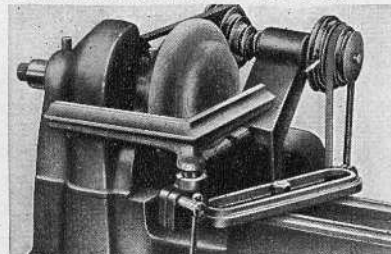

**9L88—RIGHT-ANGLE TOOL REST**—Increases accuracy and convenience of face plate turning. Fits standard bed bracket.

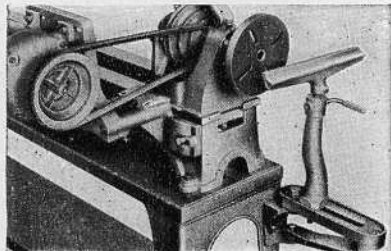

**9L54—TOOL REST BRACKET**—9L54 outside tool rest bracket used when large face plate work is turned on left end of spindle. Fits L952 lathes. Includes 12" tee.

9L59—Same as 9L54, but for L1152.

5L51—Direct drive motor bracket. (Fits L951 Lathe only.)

LATHE  
ACCESSORIES

# WALKER-TURNER MACHINE TOOLS

# WOOD AND METAL WORKING

## LATHE CENTERS AND ARBORS

9L Series Centers have No. 2 Morse Taper.

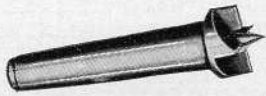

**SPUR CENTERS**

9L25—For "900" and "1100" lathes.



**CUP CENTERS**

9L26—For "900" and "1100" lathes.

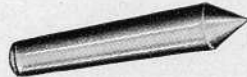

**60 DEGREE CENTERS**

9L27—For "900" and "1100" lathes.



**JACOBS CHUCK ARBORS**

9L28—For "900" and "1100" lathes.

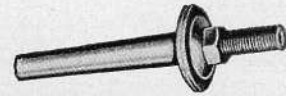

**THREADED ARBORS**

9L29—For "900" and "1100" lathes, 1/2" diam.



**BALL-BEARING CENTER**

M59—60° and cup center points. No. 2 M.T.

## METAL TURNING ACCESSORIES

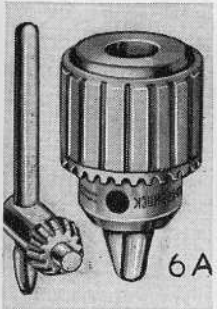

6A

**JACOBS KEY CHUCKS**  
6A—0" to 1/2" used with chuck arbors on "900" and "1100" lathes.

33—1/16" to 1/2" used with chuck arbors on "900" and "1100" lathes.

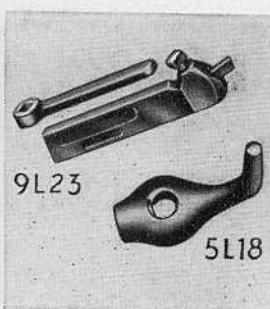

9L23

5L18

**TOOL HOLDERS**  
9L23—With bit and wrench. For 9L56 rest.

3/4" **LATHE DOG**—Used on "900" and "1100" models in conjunction with 6" face plates for holding metal rods or tubes to be turned.

5L18—Fits all models.

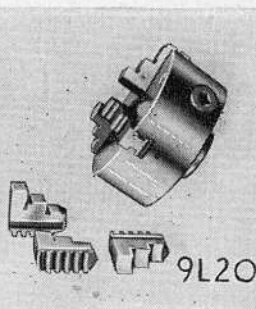

9L20

**4" LATHE CHUCKS**  
9L20—4" Universal 3-Jaw Chuck, for holding round and hexagonal work pieces. Fits both "900" and "1100" Series Lathes.

One set (3) of inside jaws, and one set (3) of outside jaws are included with the chuck. A wrench is also supplied.

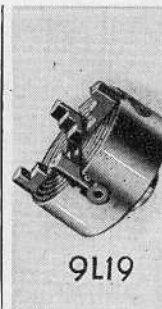

9L19

**4" LATHE CHUCKS**  
9L19—4" Independent 4-Jaw Chuck, for holding irregular shaped work pieces. Fits both "900" and "1100" Series Lathes.

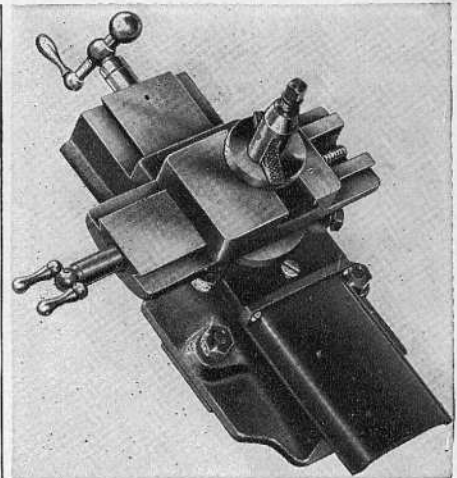

**COMPOUND SLIDE REST**

9L56—For L952 and L1152 lathes.

## WOOD AND METAL LATHE ACCESSORIES

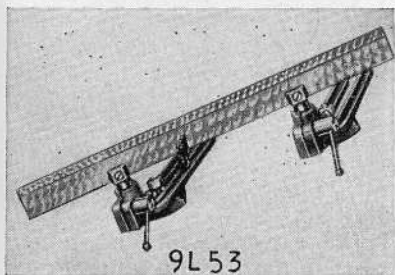

9L53

**18" and 24" TOOL RESTS**  
9L53—24" For "900" and "1100" lathes. (Temporarily Discontinued)

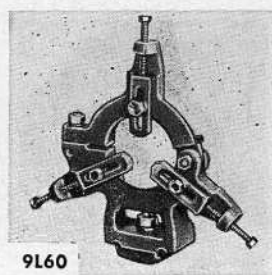

9L60

**STEADY RESTS**  
9L60—For L952 and L1152 lathes.

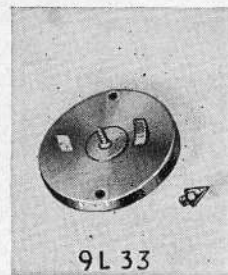

9L33

**FACE PLATE WITH SPURS**  
9L33—3" For "700" and "900" lathes.

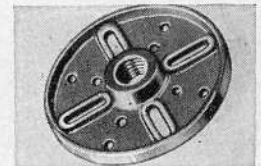

**FACE PLATES**

9L34—6 1/4" For "700" and "900" lathe, left thread.

9L35—6 1/4" For "700" and "900" lathe, right thread.

Face plate is of close grain cast-iron, carefully ground and turned to assure concentricity.

# WALKER-TURNER MACHINE TOOLS

LATHE  
ACCESSORIES

# 24" DIRECT DRIVE JIG SAWS

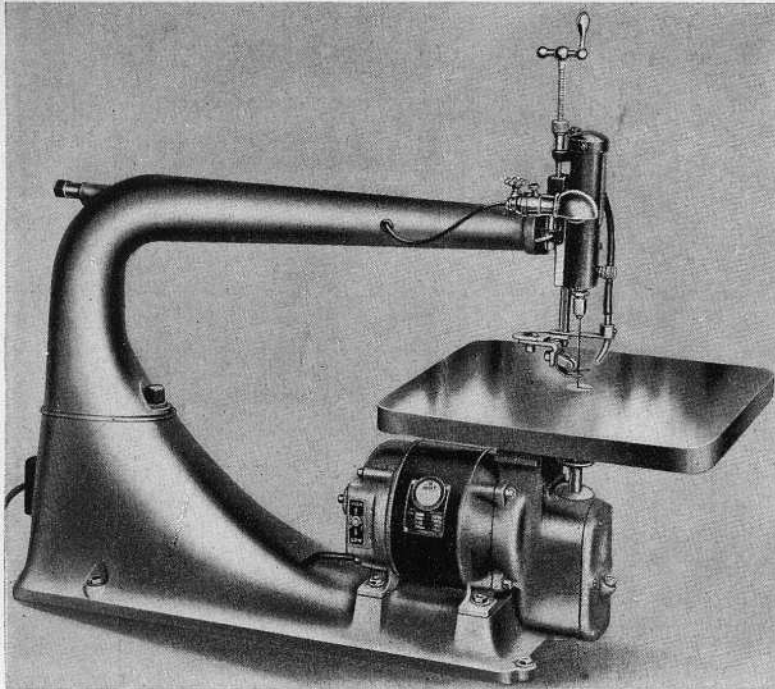

U. S. Pat. No. 2,116,122; 2,116,123; 2,165,002.  
Other Pats. Pending

Direct drive models available in two types, single speed and two speed.

Patented blade tensioner reduces blade breakage and permits varying the tension without stopping machine.

Direct drive mechanism eliminates all pulleys and belts.

Lubrication of entire driving mechanism taken care of at one point.

Blower keeps work cleared of sawdust.

Roller guide accommodates all sizes of blades from the smallest fret blades to saber blades. Table tilts to 45°, has soft metal insert around blade.

On the two-speed model speeds may be shifted from low to high or high to low without stopping the motor. Convenient switch.

**BENCH**—Heavy bench has cast-iron legs, wood top and shelf, makes the ideal mounting.

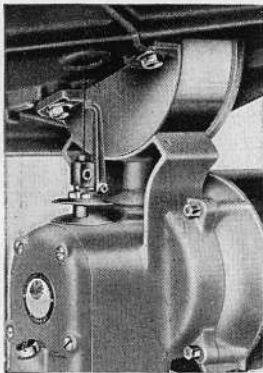
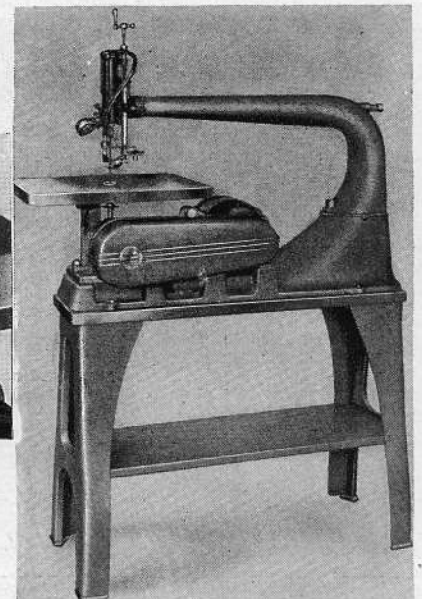

**BLADE SUPPORT**—This bracket gives extra support to the blade, under the table. It moves with the blade, consequently does not overheat it through friction.

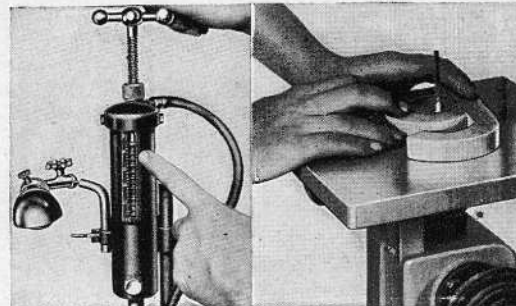

**PATENTED TENSIONER**—Different sized blades require different tension. With this patented Walker-Turner tensioner the tension can be varied without stopping machine.

**SABRE SAWING**—Because these blades are heavy they do not need to be held by the upper vise. By removing the upper arm large panels can be handled.

**MJ744**—24" Direct Drive Jig Saw, as shown above, but without lamp or blade, with single speed 1140 R.P.M. motor A.C. 110 volt 60 cycles. (220 volt, 60 cycles, extra; 110 volt, 50 cycle, extra; 3 phase 220 volt, 60 cycles, extra. Not available for D.C.).

**MJ917**—24" Direct Drive Jig Saw, as shown, including 2-speed 1140-820 R.P.M. motor. (A.C. 110 volts, 60 cycles only).

**JL3**—Lamp with bulb.

**MJ75**—Vises for large blades (used on MJ744, MJ917).

**J52**—Bench for MJ744 and MJ917. Weight 57 lbs. 28" long x 8¼" wide x 26¼" high.

(For motors of other specifications write factory.)

## SPECIFICATIONS

**DRIVING MECHANISM:** Built in with motor to provide direct drive . . . no belt or pulleys. Connecting rod is dropforged, bronze-bushed. Crank pins are hardened and ground steel. Splash system of oiling.

**CAPACITY:** Throat 24"; upper vise to table with 6" blades 2¾", extra capacity if longer blades are used.

**TABLE:** 15" x 14", machined cast-iron heavily ribbed. Soft metal insert in table around blade. Table tilts to 45° and has graduated quadrant.

**BLADE TENSIONER:** Adjustable, a few turns of the handle changes spring tension for each size of blade.

**HEAD:** Bearings are bronze. A blower is built into head and hose directs stream of air onto work.

**BLADE VISES:** Have positive locks and take plain end blades up to ⅝" wide.

**ROLLER GUIDE:** Accommodates various sizes of blades.

**SPRING HOLD-DOWN:** To prevent work being lifted on upstroke.

**HEIGHT:** Overall with stand 54", without stand 29".

**SHIPPING WEIGHT:** Approximately 217 lbs. with stand. 160 lbs. without stand for MJ744. MJ917 weighs 225 lbs. with stand, 168 lbs. without stand.

JIG  
SAWS

# WALKER-TURNER MACHINE TOOLS



# 24" 4-SPEED JIG SAW

4 speeds, 600, 900, 1250 and 1740 R.P.M.

Patented tensioner minimizes blade breakage.

Large table area, 16"x12½" . . . tilts to 45°.

New driving mechanism insures smoother operation.

**STURDY PARTS THROUGHOUT** — This under-table view shows the rugged table, table bracket, blade vise, main housing and guard bracket, also the convenient location of the motor switch. The superior construction of the base, arm and tensioning device is shown in the large photo at right.

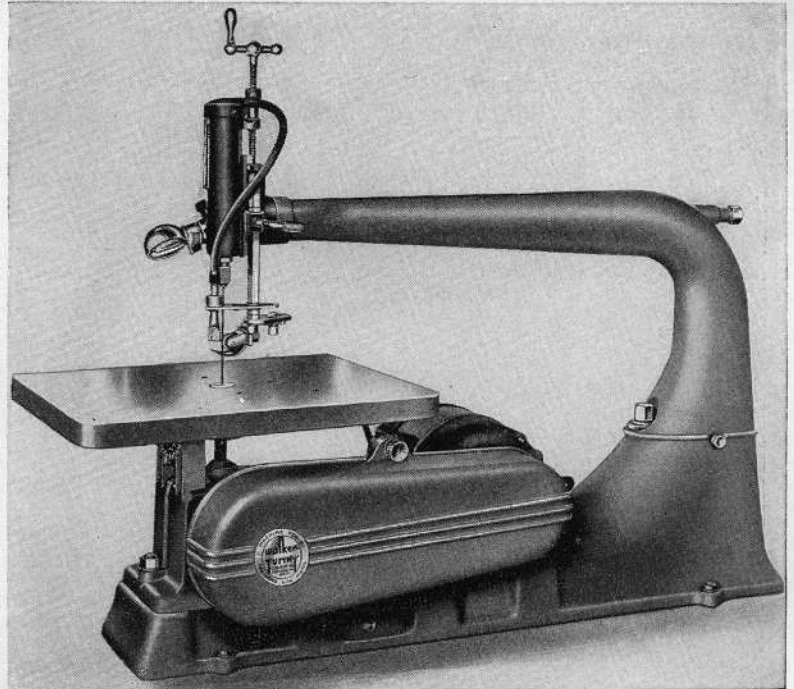
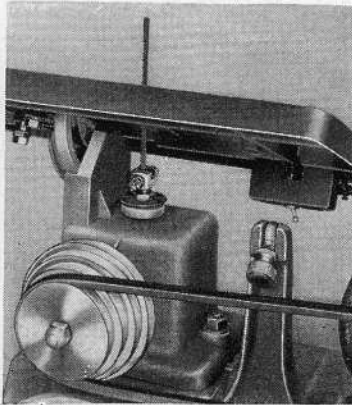

U. S. Pat. No. 2,116,122; 2,116,123; 2,165,002. Other Patents Pending.

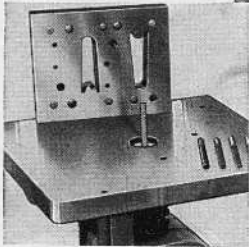

**DIE-FILING**—This machine has the low speeds necessary for die-filing. This photo shows a die that has been filed on the W-T jig saw. Machine files cannot be used on the MJ744 and MJ917 models.

## SPECIFICATIONS

**NEW DRIVE MECHANISM:** Reciprocating type replaces crosshead construction to provide much smoother operation.

**THROAT CAPACITY:** 24", arm may be swung to either side or removed completely for larger work.

**TABLE:** 16" x 12½", machined cast-iron, tilts to 45°, has graduated quadrant.

**PATENTED HEAD:** Same as used on 24" direct-drive models. Capacity vise to table 2¾" with 6" blade.

**BLOWER:** Forces air stream through hose onto work.

**OILING:** Splash system.

**ROLLER GUIDE:** Accommodates all sizes of blades and is fully adjustable.

**VICES:** Large vises, 5J4, are required for sabre sawing and die-filing.

**HEIGHT:** Overall with bench 50½", without bench 25½".

**LENGTH:** 33".

**SHIPPING WEIGHT:** Approximately 192 lbs. with bench, without bench or motor 132 lbs.

**J782**—24" belt drive jig saw, as shown, less motor, belt guard and lamp; including motor pulley and 32" belt.

**7J125**—Belt guard.

**J13**—Lamp with bulb.

**5J4**—Pair of vises for large blades and files.

**J51**—Bench for J782. 33¾" long x 8½" wide x 26¼" high. Weight, 60 lbs.

Motor recommended ¼ or ⅓ H.P., 1740 R.P.M. Do not use a motor of higher speed.

## JIG SAW ACCESSORIES, BLADES AND FILES

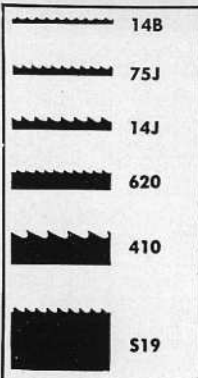

6" FRET AND JIG SAW BLADES					
CAT. NO.	THICKNESS	WIDTH	TEETH PER INCH	USED FOR CUTTING	PRICE
14B	.018	.035	21	Wood, veneer, plywood	
6J	.017	.035	32	Metal, hard substances & wood	
13B	.010	.045	18	Wood, veneer, plywood	
75J	.016	.054	20	Metal, hard substances	
6M	.022	.070	32	Metal only up to ⅛" thick	
14J	.020	.072	15	Metal over ⅛", and wood	
610	.020	.110	10	General purpose, wood, metal	
615	.020	.110	15	General purpose, wood, metal	
620	.020	.110	20	General purpose, wood, metal	
410	.028	.187	10	Thick stock, wood	
519	.022	5/16"	20	Steel	
FB9	.042	5/16"	9	Molded brake lining	
316	.040	3/16"	9	Sabre blade, for wood	
516	.040	5/16"	9	Sabre blade, for wood	



### MACHINE FILES

Machine files are used on the J782 Jig Saw. Vise No. 5J4 is required for holding files. ⅜" diameter of shank.

**MF1**—Three Square File.

**MF2**—Half Round File.

**MF3**—Round File.

**MF4**—Crochet File.

**MF5**—Pillar File.

**MF6**—Square File.

# WALKER-TURNER MACHINE TOOLS

JIG  
SAWS

# W-T CUSTOM-BUILT MOTORS



Motors in the standard frame group include  $\frac{1}{3}$  to 1 H.P. single phase,  $\frac{1}{3}$  and  $\frac{1}{2}$  H.P. split-phase,  $\frac{1}{3}$  to 1 H.P. Capacitor type, and  $\frac{1}{3}$  to 1 H.P. three phase. All motors are designed and built to Walker-Turner specifications, and cannot be obtained under any other brand name.

Highly efficient, cool running. Temperature rise not to exceed  $40^{\circ}$  under full load conditions (unless otherwise noted).

Every motor guaranteed to develop  $2\frac{1}{2}$  to 3 times its horse power rating for intermittent periods.

Motor feet cast integral with end bells. Machined on bottom for uniform height and alignment.

End bells diamond-bored for bearings. Selected precision ball bearings used throughout unless otherwise noted.

Approved switch and 30" extension cord for remote control supplied on practically all models.

All rotors are of copper bar construction. Copper end rings are brazed with silver alloy (not soldered).

Capacitor start motors wound for 110 and 220 volts.

**SERVICE REQUIREMENTS** of motors used with portable and semi-portable power tools are unusually severe. These motors must be rugged, compact and free from excess weight yet they must be able to stand up under severe and continuous overloading.

Because in the past the chief limiting factor in the development of better and more efficient power tools has been the motor, Walker-Turner engineers have worked consistently toward the development of a highly efficient compact motor—one that would develop maximum power for the weight of material employed.

**MOTORS USED** with W-T tools are not general purpose motors but are designed and built expressly for the powering of Walker-Turner machines. By building a motor expressly for the machine on which it is to be used, we have been able to get a much higher over-all efficiency and utility.

Starting with a correct basic design, Walker-Turner motors have been constantly improved and every advantage taken of new methods and materials. By the use of new heat resisting insulation, silver brazed copper rotors, welded connections throughout, a highly efficient ventilating system, and ball bearings which carry sufficient lubrication for months of constant service, Walker-Turner motors will not only develop  $2\frac{1}{2}$  to 3 times their rated H.P. for intermittent periods but will operate continuously under full load conditions with a minimum of care and attention.

**Selection of Motors:** As stated above, Walker-Turner motors are designed for the machines but quite frequently the kind of current available will influence the selection of the motor to be used. Almost without exception, the best type of motor for any machine is a poly-phase (two or three phase) motor. But where two or three-phase current is not always to be had, two types of single phase motors are available.

MOTORS

WALKER-TURNER MACHINE TOOLS

# W-T CUSTOM-BUILT MOTORS

## POLY-PHASE MOTORS

Motors from this group should be used where two or three-phase current is available because of their outstanding efficiency, high torque and quiet operation. They will handle all hard starting loads, regain speed quickly after loading and are exceptionally cool running. Standard motors are 220 volts, three-phase: two-phase and odd voltage and frequency are available on special order. H.P. sizes range from 1/3 to 3 H.P.

## CAPACITOR START MOTORS

These single phase motors should be used for hard starting applications and for use where overloading is apt to be constant. They have more than 300% full load starting torque and will continue to perform under extremely hard use. Circular saws, jointers and band saws will operate at top efficiency when operated with this type motor. The open type fan ventilated construction assures cool operation under all conditions.

All capacitor motors have 10' of approved cord, a rubber covered plug and a control switch mounted on a 2' extension. Direction of rotation may be changed in the terminal box. Made for operation on 110 or 220 volts at 60 cycles: other voltage and cycles obtainable on special order. H.P. sizes from 1/3 to 2 H.P.

## SPLIT PHASE MOTORS

These single phase motors are built for continuous operation and will perform well under any service not requiring more than 200% of full load starting torque.

They may be used on drill presses, lathes or any other machines within their capacity but should not be used where frequent starting is required or where the motor is subject to constant stalling.

Standard split phase motors are available from 1/3 to 1/2 H.P. at 1740 R.P.M. Direction of rotation may be changed in terminal box. Standard motors are wound for 110 volt, 60 cycle current. They are also available in odd voltage and frequency.

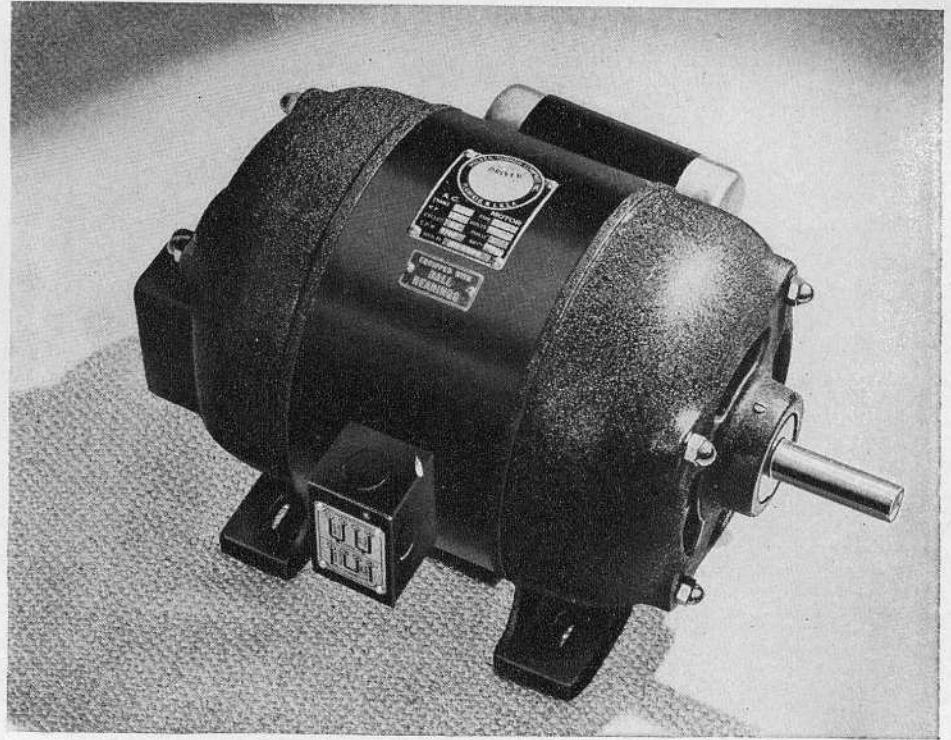

## New Larger Frame Size Motors

Motors in the large frame group include the 1 1/2 and 2 H.P. Capacitor Type and the slow speed and dual 3/4 H.P. 3 phase, the 1 1/2 and 2 H.P. 3 phase motors. Proportionately larger and heavier, they will not fit standard machine motor base without the use of NB23A Adapters.

## W-T MOTOR ACCESSORIES

**T55—Remote control switch with 30" of rubber covered cord.** May be used on any make of single phase motor up to 1 H.P. 220 volts.

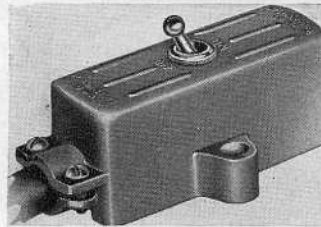

**Location for Lathe—(below)** Installed on the lathe in front of the bed, the remote control switch affords great convenience to the operator.



**Attached to Drill Press—(below)** The remote control switch can quickly be attached to drill press heads as illustrated above, or it can be mounted on the bench if preferred.

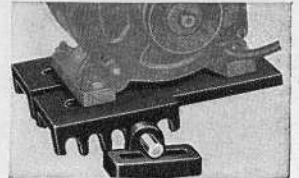

**9P5—ROCKER TYPE BASE—(above)** Used on horizontal drives. Weight of motor keeps belt at proper tension.

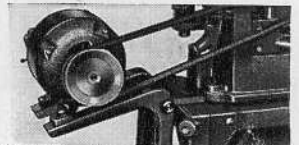

**AD17—HINGED MOTOR BASE—(above)** Ideal mounting with bench saws or jointers.



**MB1—PAIR OF MOTOR RAILS—(above)** Motor rails can be mounted at any required distance apart and used with most motors.

# W-T GEARED MOTORS

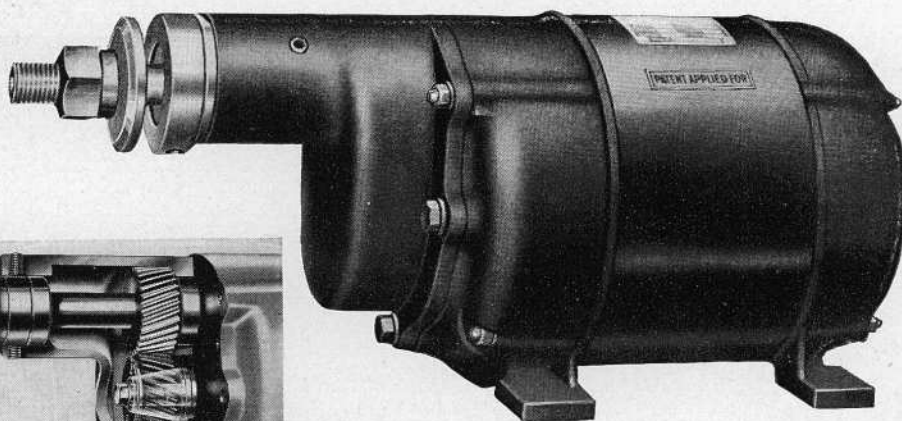

1/2, 3/4, 1 and 1 1/2

HORSEPOWER

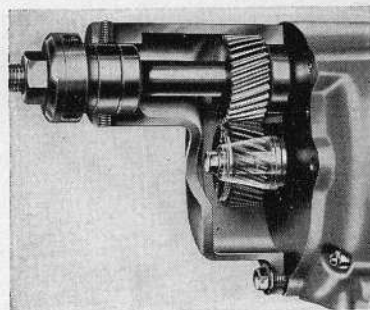

**CORRECT DESIGN.** The drawing shows how every detail of good design has been built into the gear assembly. One gear in each pair is made of fabric impregnated with bakelite, the other is steel. This affords smoothness, quietness and long life. Large precision ball bearings carry motor shaft and gear shaft, four used. Note cut-away gears and cone clutch elements. A special non-fluid lubricant is used in all W-T geared motors.

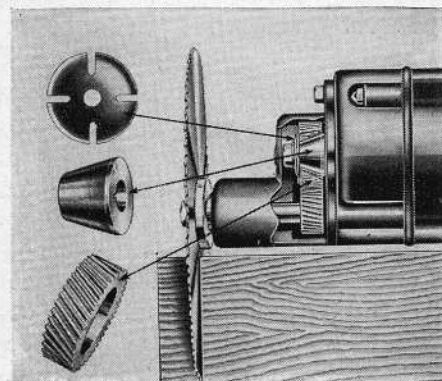

**POSITIVE PROTECTION.** Complete mechanical and electrical protection is afforded motor users thru exclusive features built into W-T geared motors. When a geared motor is suddenly stalled a terrific impact is thrown on the gear teeth resulting from the inertia stored up by the fast revolving rotor. To safeguard their motors under such conditions W-T engineers developed a slip-clutch which is built into one of the gears in each pair. When the shock occurs this gear slips momentarily easing the load on the teeth. No resetting is ever necessary. In the many years this clutch has been in use not a single case of gear breakage has been reported.

Improved ventilation insures maximum temperature rise not to exceed 40° C.

Motors guaranteed to develop 300% of full load H.P. for intermittent service, more than full-rated power for continuous service.

Gears are fabric-impregnated bakelite and steel, protected by a shock-absorbing clutch. Guaranteed for one year.

Selected precision ball-bearings used, 2 on spindle, 2 in motor.

2 and 3 H.P. motors have double row of bearings on spindle.

Magnetic circuit breaker switch protects motors against overloading.

Cast-iron end bells, gear housing diamond bored to take bearings.

High silica, electric sheet steel laminations in rotor and stator annealed after punching. Rotor of copper bar construction with copper end rings brazed with silver alloy.

Air-filtering device supplied on 1 H.P. geared motors for circular saws: for other motors on special order.

A most severe service for fractional and integral horsepower motors is powering relatively small circular saws. Larger machines may be overpowered to a point where motor load is not so severe, but smaller saws, because of portability, must employ motors operating almost constantly under full load. W-T engineers knowing ordinary motors couldn't be expected to give satisfactory results, developed the geared motor. Eliminating belt and pulleys was the greatest step for with gears transmission efficiency of 97-98% was obtained whereas with belt drive losses in transmission often ran as high as 40%.

This power saving was put to work at the tooth of the saw.

By constant research our engineers have improved the efficiency to a point where we believe W-T motors are the most compact and efficient made and will develop greater H.P. per pound of material used than any other motor on the market. Geared motors of 1 to 3 H.P. are guaranteed to have a pull-out torque up to 300%, or, a 1 H.P. motor will develop nearly 3 H.P. before stalling. This is true to a greater extent in the 1 and 3 H.P. three-phase motors.

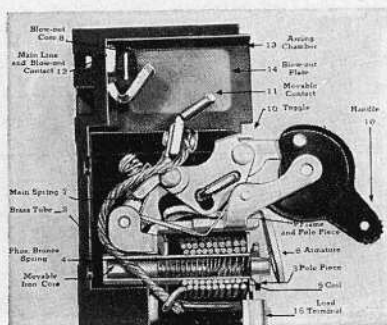

**MAGNETIC CIRCUIT BREAKERS.** Protection for the motor itself against damage due to overloading is supplied by a new type magnetic circuit breaker. This switch permits motor to operate continuously at full load and to carry 2 to 3 times full load for short periods, usually up to 2 or 3 seconds. If the load continues to a point where it would cause dangerous overheating the breaker trips and cuts the motor off the line. The motor may be reconnected immediately.

**MBS5** Circuit breaker for single phase motors of 2 H.P. or less. Specify size and type of motor

**5062** C. B. switch for 1 1/2 and 3 H.P. 3 phase, 200 volt.

**5064** C. B. switch for 1 1/2 and 3 H.P. 440 volts

**F927** Non-fluid oil (3450 R.P.M. motors)

MOTORS

WALKER-TURNER MACHINE TOOLS

# FOR SHAPERS and SAWS

## 2 and 3 HORSEPOWER



Two new additions to the Walker-Turner line of geared motors are a 2 H.P. single phase and a 3 H.P. three-phase motor. These are by far the most powerful motors we have yet produced. They have overload ratings far in excess of those shown on their plates.

While the standard Walker-Turner geared motors have a spindle speed of 3450 R.P.M. with the rotor turning at the same speed the 2 and 3 H.P. models have a spindle speed of 3000. This speed reduction adds greatly to the power delivered at the tooth of the saw blade. Because they are designed to carry 12" blades a spindle speed of 3000 R.P.M. was selected as the best operating speed for that diameter blade. These motors were designed for the Radial Saw and cannot be used on Tilting Arbor Saws. They are also available with a speed of 7600 R.P.M. for use on S975L

Spindle Shaper. Magnetic Circuit Breaker switches listed on opposite page.

### NEW 1/2 H.P. and 3/4 H.P. SLO-SPEED MOTORS

Primarily for powering the slow speed metal-cutting band saws, these motors can be adapted wherever slow constant speed is required. The motor speed of 1740 R.P.M. is reduced at the operating spindle to a speed of 716 R.P.M. Available in 1/2 H.P. single phase and 3/4 H.P. three phase. See page 12.

### TWO-SPEED MOTORS

A further development now makes it possible to supply 1/2 and 2 H.P. three phase Geared Motors in two-speed combinations. Speeds are controlled by an interlocking push-button switch which gives instantaneous speed changes at the touch of a button.

Motor speeds available are:— 1140, 1740 and 3450 R.P.M. Any two speeds may be incorporated in one motor.

By changing the gear ratio the motor RPM may be doubled thereby increasing two-fold the speed range of the two speed motors.

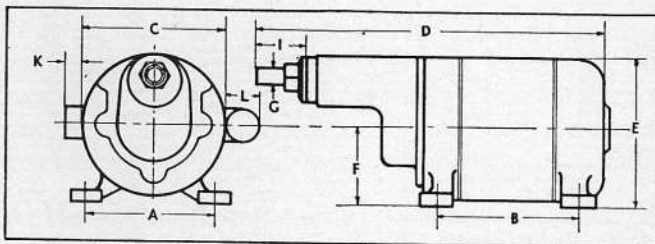

### CAPACITOR and 3 PHASE GEARED MOTORS

(Dimensions in inches)

- △ 3-Phase only.
  - Overload Switch supplied.
  - Drum Reversing Switch supplied.
- 220 to 250 volts extra. 440 volts extra. 3-phase extra. Not available for Direct Current or for 25 and 40 cycles.

Cat. No.	Key	H.P.	Volts	RPM	Frame No.	A	B	C	D	E	F	G	I	K	L	Wgt.
GB-5	□	1/2	110-220	3450	118	5 1/4	5 3/8	6 3/8	14 1/2	6 1/2	3 3/8	5/8	1 5/8	1 3/8	2 1/4	60
GB-5S	□	1/2	110-220	7600	118	5 1/4	5 3/8	6 3/8	14 1/2	6 1/2	3 3/8	—	—	1 3/8	2 1/4	60
GIB-5	△	1/2	110-220	716	118	5 1/4	5 3/8	6	15	7 3/4	3	5/8	1	1	2 1/4	66
GIB-7	△	3/4	220	716	120	5 1/4	5 3/8	6	15	7 3/4	3	5/8	1	1	2 1/4	70
GB-7X	□	3/4	110-220	7600	120	5 1/4	5 3/8	6	15	6 1/2	3 3/8	—	—	—	2 1/4	68
GB-7T	□	3/4	110-220	7600	120	5 1/4	5 3/8	6	15	6 1/2	3 3/8	5/8	1 5/8	1 3/8	2 1/4	68
GB-10	●	1	110-220	3450	120	5 1/4	5 3/8	6	15	6 1/2	3 3/8	5/8	1 5/8	1 3/8	2 1/4	68
GB-10S	□	1	110-220	7600	120	5 1/4	5 3/8	6	15	6 1/2	3 3/8	—	—	1 3/8	2 1/4	68
GB-12	□	1	110-220	3450	120	5 1/4	5 3/8	6	15	6 1/2	3 3/8	3/4	2 1/2	1 3/8	2 1/4	80
GB-15	△	1 1/2	220	3450	120	5 1/4	5 3/8	6	15	6 1/2	3 3/8	3/4	2 1/2	1 3/8	—	80
GB-15A	△	1 1/2	220	3450	120	5 1/4	5 3/8	6	15	6 1/2	3 3/8	—	—	1 3/8	—	80
GB-15S	□	1 1/2	220	7600	120	5 1/4	5 3/8	6	15	6 1/2	3 3/8	5/8	1 5/8	1 3/8	—	80
GB-20	□	2	220	3000	127-B	5 3/4	5 3/4	8	20 3/4	8 3/4	4 3/4	3/4	2 1/2	—	2 1/4	140
GB-20S	□	2	220	7600	127-B	5 3/4	5 3/4	8	20 3/4	8 3/4	4 3/4	—	—	—	2 1/4	140
GB-30	□	3	220	3000	127-B	5 3/4	5 3/4	8	20 3/4	8 3/4	4 3/4	3/4	2 1/2	—	—	165
GB-30S	□	3	220	7600	127-B	5 3/4	5 3/4	8	20 3/4	8 3/4	4 3/4	—	—	—	—	165

**STARTING SWITCH.** An important development is found in the W-T 2 H.P. single phase geared motor. It is the oversize, centrifugal starting switch\*, mounted outside the body of motor... not inside as is common practice.

\*All single phase motors require a starting device which in most instances is a centrifugal switch. Once the motor attains its normal speed the switch cuts out and the motor runs without the use of brushes which require attention and maintenance. Single phase motors have no brushes at all. All capacitor or condenser motors are single phase motors.

# W-T MOTOR DATA

Factors to be considered in the selection of motors for power tool equip-

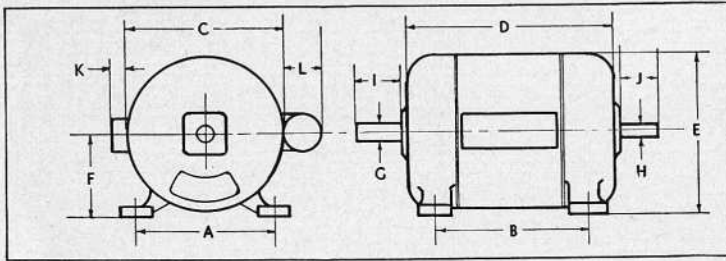

ment are the electric current available, type of service, and initial cost. Three-phase motors are superior to all other types and their use is recommended wherever three-phase power is available.

Next, from the standpoint of service comes the capacitor-start motor, which has a high starting and running torque, low starting current, and is suitable for all types of power drives.

Repulsion-induction motors are recommended in sizes larger than 1 H.P. when three-phase current is not available.

Split-phase motors have a higher starting current inrush and a lower starting torque than any of the above motors. Consequently they are seldom built in sizes larger than 1/3 or 1/2 H.P. Their running torque, however, compares favorably with either the capacitor-start or the repulsion-induction motor, and they are entirely satisfactory where the starting load is relatively light.

## SPLIT PHASE MOTORS (60 CYCLES)

Dimensions in Inches

Cat. No.	H.P.	Volts	RPM	Frame No.	A	B	C	D	E	F	G	H	I	J	K	Keyway			Wgt.	Key to Foot notes	
																Width	Depth	Length			
SAB3	1/3	110	1740	115	5 1/4	4 7/16	6 1/16	7 1/4	6 3/16	3 3/8	1/2	5/8	1 3/8	2	—	—	1 1/8"	3/16"	1 1/2"	28	□
SAB5	1/2	110	1740	118	5 1/4	5 1/16	6 1/16	8	6 3/16	3 3/8	1/2	5/8	1 3/8	2	—	—	1 1/8"	3/16"	1 1/2"	40	□

## THREE-PHASE MOTORS (60 CYCLES)

PAB3	1/3	220	1740	115	5 1/4	4 7/16	6 1/16	7 1/4	6 3/16	3 3/8	1/2	5/8	1 3/8	2	1 3/8	1 1/8"	3/16"	1 1/2"	28	△
POB3	1/3	220	1140	115	5 1/4	4 7/16	6 1/16	7 1/4	6 3/16	3 3/8	1/2	5/8	1 3/8	2	1 3/8	1 1/8"	3/16"	1 1/2"	28	△
PAB5	1/2	220	1740	118	5 1/4	5 1/16	6 1/16	8	6 3/16	3 3/8	1/2	5/8	1 3/8	2	1 3/8	1 1/8"	3/16"	1 1/2"	40	△
PEB5	1/2	220	3450	118	5 1/4	5 1/16	6 1/16	8	6 3/16	3 3/8	1/2	5/8	1 3/8	2	1 3/8	1 1/8"	3/16"	1 1/2"	40	△
POB5	1/2	220	1140	120	5 1/4	5 1/16	6 1/16	8 1/2	6 3/16	3 3/8	1/2	5/8	1 3/8	2	1 3/8	1 1/8"	3/16"	1 1/2"	40	△
LPAEB5	1/2	220	1740	120	5 1/4	5 1/16	6 1/16	8 1/2	6 3/16	3 3/8	1/2	5/8	2	2 1/4	1 3/8	1 1/8"	3/16"	1 1/2"	40	☆
PAB7	3/4	220	1740	120	5 1/4	5 1/16	6 1/16	8 1/2	6 3/16	3 3/8	5/8	5/8	2	2	1 3/4	1 1/8"	3/16"	1 1/2"	62	△
PEB7	3/4	220	3450	120	5 1/4	5 1/16	6 1/16	8 1/2	6 3/16	3 3/8	5/8	5/8	2	2	1 3/4	1 1/8"	3/16"	1 1/2"	44	△
PIB7	3/4	220	865	P.R.204	8	6 1/2	8 1/2	9	8 7/8	4 1/2	3/4	3/4	2 1/2	2 1/2	1 3/4	1 1/8"	3/16"	2 1/8"	76	#
POB7	3/4	220	1140	125	6 1/2	6 1/2	8 1/4	10 7/8	8 3/8	4 1/4	—	3/4	—	2 1/4	1 3/8	1 1/8"	3/16"	1 1/2"	75	☆
PAEB7	3/4	220	1740	125	6 1/2	6 1/2	8 1/4	10 7/8	8 3/8	4 1/4	—	3/4	—	2 1/4	1 3/8	1 1/8"	3/16"	1 1/2"	75	☆
POEB51	1/2-1	220	1140	125	6 1/2	6 1/2	8 1/4	10 7/8	8 3/8	4 1/4	—	3/4	—	2 1/4	1 3/8	1 1/8"	3/16"	1 1/2"	75	☆
PEB10	1	220	3450	120	5 1/4	5 1/16	6 1/16	8 1/2	6 3/16	3 3/8	5/8	5/8	2	2	1 3/4	1 1/8"	3/16"	1 1/2"	62	△
PAB10	1	220	1740	125	6 1/2	6 1/2	8 1/4	10 7/8	8 3/8	4 1/4	—	3/4	—	2 1/4	1 3/8	1 1/8"	3/16"	1 1/2"	75	△
PAB15	1 1/2	220	1740	125	6 1/2	6 1/2	8 1/4	10 7/8	8 3/8	4 1/4	—	3/4	—	2 1/4	1 3/4	1 1/8"	3/16"	1 1/2"	62	△
PEB15	1 1/2	220	3450	120	5 1/4	5 1/16	6 1/16	8 1/2	6 3/16	3 3/8	5/8	5/8	2	2	1 3/4	1 1/8"	3/16"	1 1/2"	75	△
PEB20	2	220	3450	125	6 1/2	6 1/2	8 1/4	10 7/8	8 3/8	4 1/4	—	3/4	—	2 1/4	1 3/8	1 1/8"	3/16"	1 1/2"	95	#
PEB30	3	220	3450	127-B	5 3/4	5 3/4	8	14 1/8	8 5/8	4 5/8	—	3/4	—	2 1/4	—	1 1/8"	3/16"	2 1/8"	95	#

## CAPACITOR START MOTORS (60 CYCLES, SINGLE PHASE) = 1 3/4"

KAB3	1/3	110-220	1740	114	5 1/4	4 7/16	6 1/16	7 1/4	6 3/16	3 3/8	1/2	5/8	1 3/8	2	—	1 1/8"	3/16"	1 1/2"	29	□
KEB5	1/2	110-220	3450	118	5 1/4	5 1/16	6 1/16	8	6 3/16	3 3/8	1/2	5/8	1 3/8	2	1 3/8	1 1/8"	3/16"	1 1/2"	40	□
KAB5-S	1/2	110-220	1740	118	5 1/4	5 1/16	6 1/16	8	6 3/16	3 3/8	—	5/8	—	2	1 3/8	1 1/8"	3/16"	1 1/2"	40	□
KAB5	1/2	110-220	1740	118	5 1/4	5 1/16	6 1/16	8	6 3/16	3 3/8	1/2	5/8	1 3/8	2	1 3/8	1 1/8"	3/16"	1 1/2"	40	□
KEB7	3/4	110-220	3450	120	5 1/4	5 1/16	6 1/16	8 1/2	6 3/16	3 3/8	5/8	5/8	2	2	1 3/8	1 1/8"	3/16"	1 1/2"	41	□
KAB7	3/4	110-220	1740	125	6 1/2	6 1/2	8 1/4	10 7/8	8 3/8	4 1/4	—	3/4	—	2 1/4	1 3/8	1 1/8"	3/16"	1 1/2"	62	□
KEB10	1	110-220	3450	120	5 1/4	5 1/16	6 1/16	8 1/2	6 3/16	3 3/8	5/8	5/8	2	2	1 3/8	1 1/8"	3/16"	1 1/2"	62	#
KEB15	1 1/2	110-220	3450	125	6 1/2	6 1/2	8 1/4	10 7/8	8 3/8	4 1/4	—	3/4	—	2 1/4	1 3/8	1 1/8"	3/16"	1 1/2"	95	#
KEB20	2	220	3450	127-B	5 3/4	5 3/4	8	14 1/8	8 5/8	4 5/8	—	3/4	—	2 1/4	—	1 1/8"	3/16"	2 1/8"	95	#

## DIRECT CURRENT MOTORS

DAB3	1/3	115	1740	5 1/8	3 7/8	6 1/2	6 3/4	7	3 5/8	1/2	1/2	1 1/2	1 1/2	—	1/4"	Flat	1"	32	
DEB5	1/2	115	3450	5 1/8	3 7/8	6 1/2	6 3/4	7	3 5/8	1/2	1/2	1 1/2	1 1/2	—	1/4"	Flat	1"	35	
DEB7	3/4	115	3450	6 1/4	5 1/2	8	8 1/2	8	4 1/4	3/4	3/4	2 1/4	2 1/4	1 1/4	1 1/8"	Flat	1 3/4"	81	#

## REPULSION INDUCTION MOTORS (60 CYCLES, SINGLE PHASE)

RAB3	1/3	110-220	1750	5 3/4	4 1/2	7 1/8	10 1/8	7 1/8	3 1/8	5/8	5/8	1 1/8	1 1/8	1 1/8	1 1/8	1 1/8"	3/16"	1 1/2"	50	#
RAB5	1/2	110-220	1750	7 1/2	3 3/4	8 5/8	10 3/4	8 7/8	4 1/2	3/4	3/4	2 1/2	2 1/2	1 3/4	1 1/8"	3/16"	2"	66	#	
RAB7	3/4	110-220	1750	6 3/8	5 1/4	7 1/8	11 1/8	—	4 1/8	3/4	3/4	2 1/8	2 1/8	—	1 1/8"	3/16"	2"	75	#	
RAB10	1	110-220	1750	7 3/4	4 3/4	8 1/2	9	8 7/8	4 1/2	3/4	3/4	2 1/2	2 1/2	1 3/4	1 1/8"	3/16"	2"	76	#	

All motors, excepting 3-phase, D.C., or those already having dual voltage can be supplied for 220 to 250 volts at extra cost. D.C. available for 230 volts, extra. All motors excepting SOB4 and 3-phase can be supplied in 50 cycles, extra. Three-phase motors except POB3, PIB7, POB7 and POB5 can be supplied for 50 cycles, extra. 25 to 40 cycles not available except as shown in chart. All Capacitor, Repulsion-Induction, D.C. and Split-Phase motors (except SAB35) supplied with Reversing Switch on special order, extra. (Switch not mounted on D.C. motors.) 3-Phase motors supplied with Reversing Switch on special order, extra.

Split-Phase and Capacitor motors supplied with 10 ft. cord, plug and remote control switches (unless otherwise noted). Direct current motors have cord, plug, built-in switches unless otherwise noted. All motors have ball bearings unless noted. △ 3-Phase motors have three wires in terminal box—no switch, cord or plug. ⊕ Bronze bearings. † Reverse switch included. \* Cord, plug and switch not included. □ Reversible in terminal box. ● Manually reversed. ○ Not furnished for 50 cycles. ‡ Available in 440 volts, extra. # Requires NB23A adapter when mounted on W-T machines. † Can be supplied for 25 cycles on special order. ☆ Interlocking push button switch included. Write for specifications and prices.

# TRANSMISSION EQUIPMENT

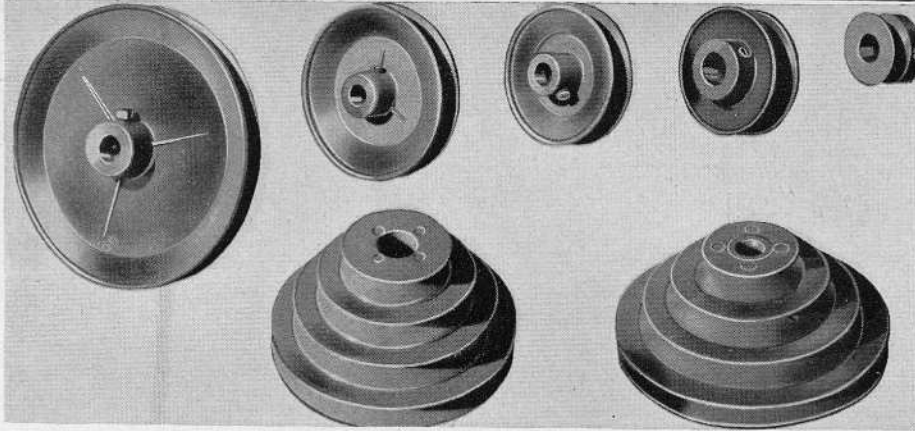

**WIDE SELECTION OF PULLEYS**—Walker-Turner pulleys are available in various diameters and bores to fit practically every need. Each pulley has two set screws for maximum holding power. Pitch of all pulley grooves is 43°.

1/2" BORE				5/8" BORE				3/4" BORE			
No.	Grooves	Inch Size of Steps		No.	Grooves	Inch Size of Steps		No.	Grooves	Inch Size of Steps	
PV175	1	1 3/4		PV158	1	1 3/4		PV275	1	2 1/2	
PV25	1	2 1/2		PV258	1	2 1/2		PV375	1	3	
PV350	1	3		PV365	1	3		PV475	1	4	
PV450	1	4		PV458	1	4		BN18	1	6 1/2	
PV65	1	6 1/2		PV658	1	6 1/2		PV37	3	3 1/4	2 1/2 1 1/4
PV30	3	3 1/4	2 1/2 1 1/4	PV35	3	3 1/4	2 1/2 1 1/4	PV47	4	3 1/4	2 3/4 2 1/4 1 3/4
PV34	4	1 3/4 1 3/4 1 3/4 1 3/4		PV45	4	3 1/4 2 3/4 2 1/4 1 3/4		PV49	4	4 3/4 4 1/4 3 3/4 3 1/4	
PV41	4	3 1/4 2 3/4 2 1/4 1 3/4		PV48	4	4 3/4 4 1/4 3 3/4 3 1/4		PV40	4	4 3/4 3 1/4 2 1/2 1 3/4	
PV43	4	4 3/4 4 1/4 3 3/4 3 1/4		PV625	4	4 3/4 3 1/4 2 1/2 1 3/4		PV575	4	5 3/8 2 1 1 3/4	
PV4	4	4 3/4 3 1/4 2 1/2 1 3/4		PV58	4	5 3/8 2 1 1 3/4		PV750	4	5 1/2 4 3/8 3 1/8 2 1/4	
PV550	4	5 3/8 2 1 1 3/4		PV62	4	5 1/2 4 3/8 3 1/8 2 1/4					
PV500	4	5 1/2 4 3/8 3 1/8 2 1/4									

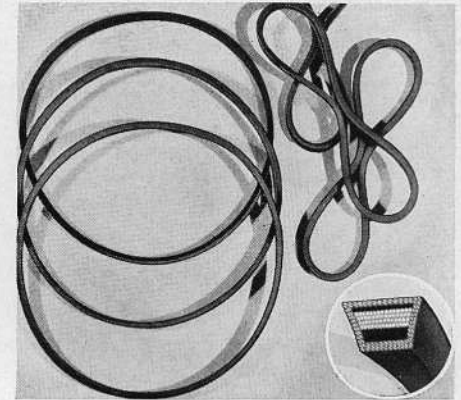

## V-BELT LISTING

VB20-20"	VB32-32"	VB54-54"
VB24-24"	VB34-34"	VB58-58"
VB26-26"	VB36-36"	3600-60"
3270-27"	VB39-39"	VB62-62"
VB29-29"	VB42-42"	VB66-66"
5332-30"	VB44-44"	VB86-86"
3310-31"	VB48-48"	VB92-92"

3VB16—Texrope Belts. Set of three matched.

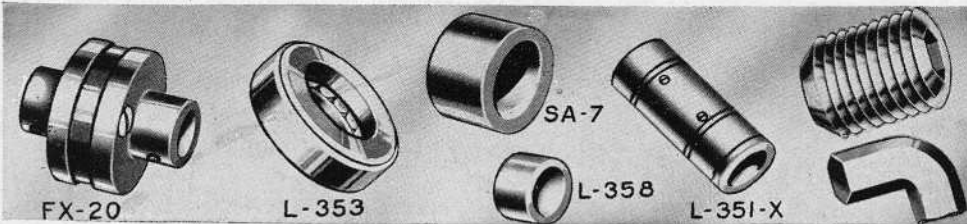

All transmission parts are for light shafting. With them a drive for light machinery can be set up very inexpensively.

**FX20**—Flexible coupling (for 1/2" shafting).  
**L351X**—Rigid coupling (for 1/2" shafting).  
**L351**—1/2" x 24" Ground steel shaft.

**COM.**—1/4" Hollow-head set screws.  
**COM.**—Wrench for above.  
**COM.**—5/8" Hollow-head set screws.  
**COM.**—Wrench for above.

**L358**—1/2" Shaft collar.  
**C58**—5/8" Shaft collar.  
**SA7**—3/4" Shaft collar.  
**L353**—1/2" Ball thrust bearing.  
**58**—5/8" Ball thrust bearing.  
**75**—1/2" Ball thrust bearing.

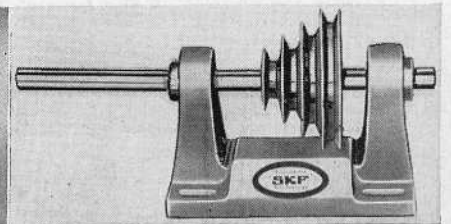

**JACKSHAFT ASSEMBLY**—This unit can be used for increasing or reducing machine speeds. The shaft turns on precision ball-bearings. Base holes are located identically with most W-T motor mountings. Four variations of speeds are provided.

**MD18**—Jackshaft assembly as shown.

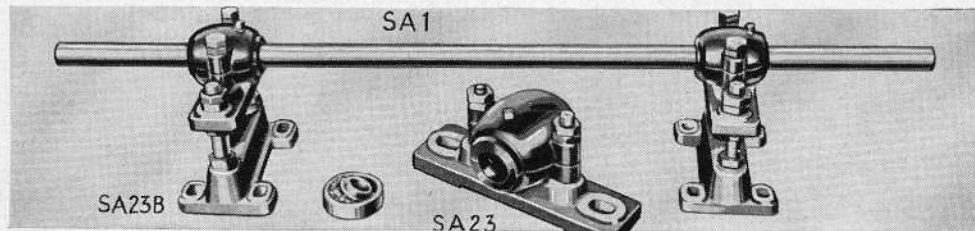

**SELF-ALIGNING BALL-BEARING HANGERS**—Friction or binding due to faulty shaft alignment is eliminated with these hangers which absorb considerable misalignment by their self-aligning feature. These bearings will more than repay the difference in cost over cheap babbit or sleeve bearings through their savings in power and attention.

**SA23B**—3/4" Hanger (with base).  
**SA23**—3/4" Pillow block only.

**SA78**—7/8" Pillow block only.  
**SA1**—3/4" x 48" Ground steel shaft.

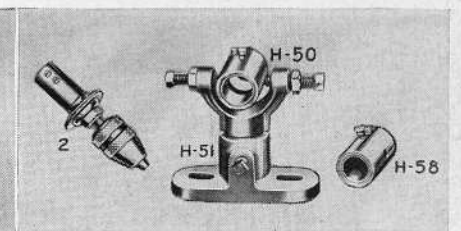

**SHAFT HANGERS FOR WORK ARBOR**—No. 2 Motor Work Arbor (with 1/2" 3 jaw chuck).  
**H51**—Hanger only (less bearing).  
**H50**—1/2" Bronze bushed bearing for H51.  
**H58**—5/8" Bronze bushed bearing for H51.  
**H75**—3/4" Bronze bushed bearing for H51.

# WALKER-TURNER MACHINE TOOLS

TRANSMISSION  
EQUIPMENT

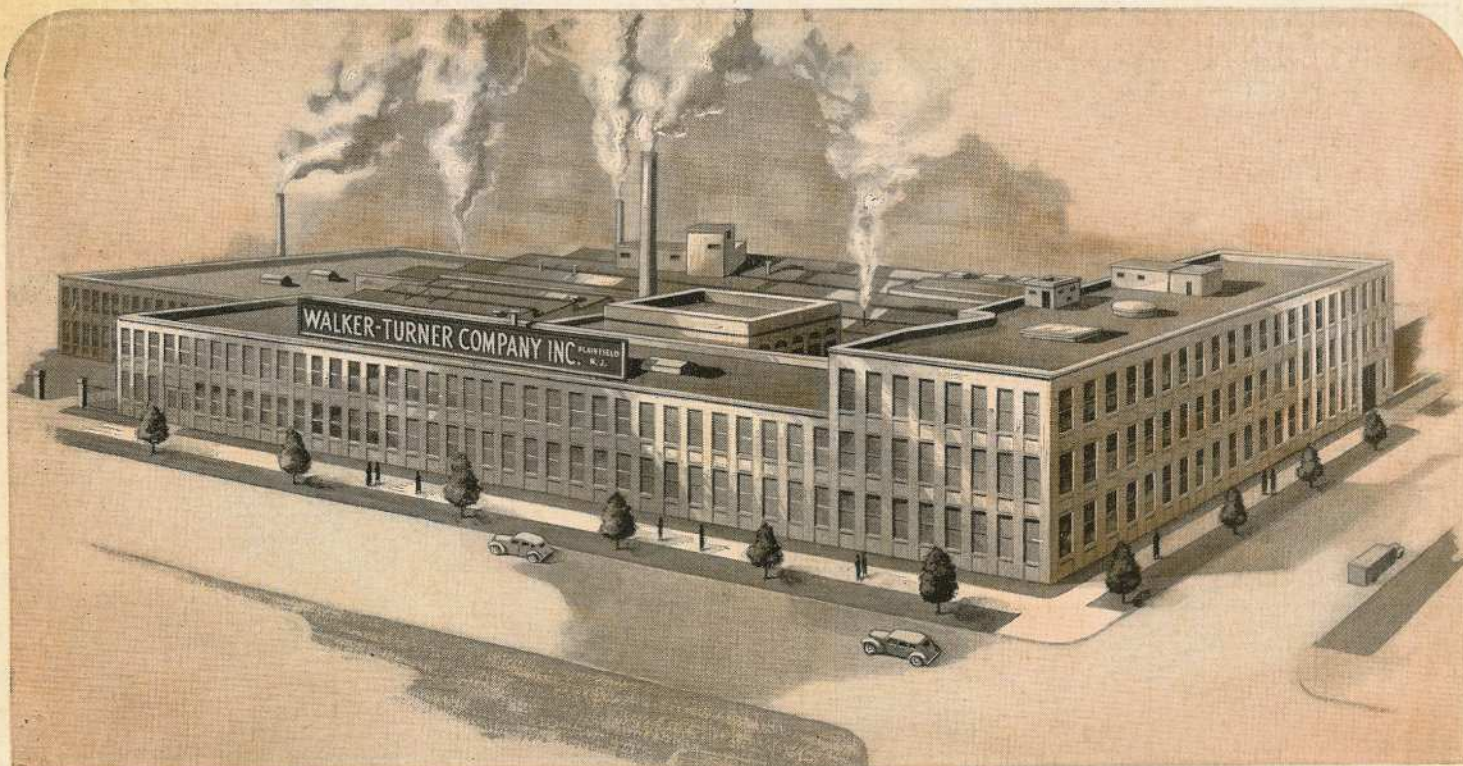

**Twenty-four hours  
a day . . . seven  
days a week . . .**



Twenty four hours a day, seven days a week, Walker-Turner production facilities are being pushed to the limit with one objective:

That is, to supply defense industries with as many machine tools of the type we build as possible, consistent with the high standards of accuracy and dependability demanded by industry.

That Walker-Turner Machine Tools are able to meet high industrial standards is best evidenced by the fact that they are in daily use the world over.

Thousands are helping in the defense of England—many have been transported over the Burma Road to China—while in the United States there are numerous installations of up to several hundred machines operating day and night.

To companies with defense production problems, we suggest: Call in your Walker-Turner Distributor for the latest information on how these machines are helping others to speed production, lower costs and keep maintenance worries at a minimum.

**WALKER-TURNER CO., INC.**  
**PLAINFIELD, NEW JERSEY, U. S. A.**  
**EXPORT OFFICE • 75 WEST ST., NEW YORK CITY**