

THE
HANDYMANS
DREAM BOOK

FEATURING MODERN

POWER-KRAFT

POWER TOOLS

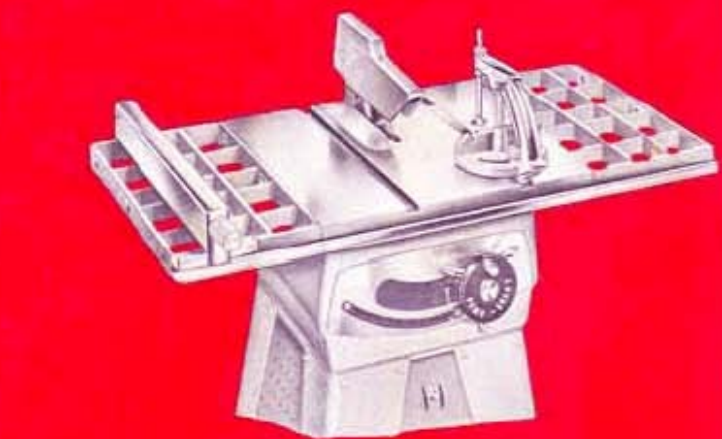

WARDS
MONTGOMERY WARD

AT WARDS

... "Do-It-Yourself-ers" always get the "best buy" on *POWR-KRAFT* tools!

AT HOME

... "Do-It-Yourself-ers" save time, money and enjoy work projects more with *POWR-KRAFT* tools!

POWR-KRAFT stands for *QUALITY*...

... PRECISION-ENGINEERING

All power tools are NOT alike! *POWR-KRAFT* tools are designed to give the most advanced features and design. They're precision-engineered to take full advantage of the newest high-precision manufacturing methods. *POWR-KRAFT* tools are built of today's lighter, stronger materials and metals!

... NEW EXCLUSIVE FEATURES

By designing for you—the customer—Wards has been able to incorporate in every *POWR-KRAFT* tool exclusive features found in no other similarly-priced tools. Features for greater efficiency, safety and longer life! Read about these features in this catalog—see them at your Wards store.

... RUGGEDLY-BUILT FOR LONG LIFE

Every *POWR-KRAFT* tool is ruggedly constructed to provide smoother operation and long, trouble-free service. Heavy-duty cast-iron frames provide greatest strength and rigidity; minimize vibration. *POWR-KRAFT* tools are precision accurate, do neater work, give professional results.

... HIGHER QUALITY—LOWER PRICED

Large-quantity buying, factory-to-Wards-to-you handling provides benefits for you. Wards operates economically; makes savings through long range planning, warehousing, shipping in large quantities. Operating costs are spread over hundreds of retail stores, 9 mail order houses. YOU share in the savings through lower prices, higher quality with *POWR-KRAFT* tools.

... FULL ONE-YEAR GUARANTEE

Buy with confidence. If any *POWR-KRAFT* tool shows defects in workmanship or materials under normal use, Wards will repair it at no charge if returned within one year of purchase-date. Satisfaction guaranteed or your money back.

... SERVICE AND PARTS PROTECTION

There's more to buying a power tool than being sure that the quality is right. YOU want assurance of the availability of parts and service. Buyers of *POWR-KRAFT* tools get this assurance. Parts are available for the life of the tool. Wards services what Wards sells without reservation.

Amateurs and "Pros" prefer *POWR-KRAFT*

WARDS HAS BEEN SERVING BOTH SKILLED AND HOBBYIST WOOD WORKERS FOR 86 YEARS!

- Home owners
 - Hobbyists
 - Builders
 - Handy men
- Machinists
 - Electricians
 - Welders
 - Institutions
- Woodworking instructors
 - Factory owners

Join the millions of smart buyers who shop at Wards for the finest quality tools at the lowest prices. Get into the habit: "Shop Wards First". You'll find everything you need for your workshop. Everything right in all Wards stores or available

promptly through special order. Always look for the name: POWR-KRAFT. It's the name of the leader in fine tools: Wards own brand name for the "best buy" in tools. Come in and see them demonstrated.

TRY OUT *POWR-KRAFT* TOOLS IN YOUR OWN HOME FOR 7 DAYS; NO CHARGE, NO OBLIGATION TO BUY!

Before you buy a POWR-KRAFT stationary tool, Wards invites you to try it out in your own home. We suggest that you give it every test—prove to yourself that it does everything we say it will. Compare it with any power tool at a comparable price. Keep it as long as a week, if you like. Ask about this free 7-day trial offer now. Wards salesman will be glad to give you the details. Just come in and ask him.

Here's how Wards 24-month payment plan stretches your power tool buying power!

**\$5 DOWN
\$5 MONTHLY**
Buys all these POWR-KRAFT tools:

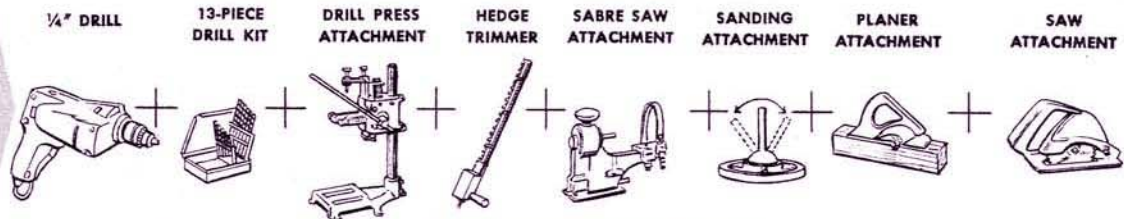

**\$5 DOWN
\$7 MONTHLY**
Buys all these POWR-KRAFT tools:

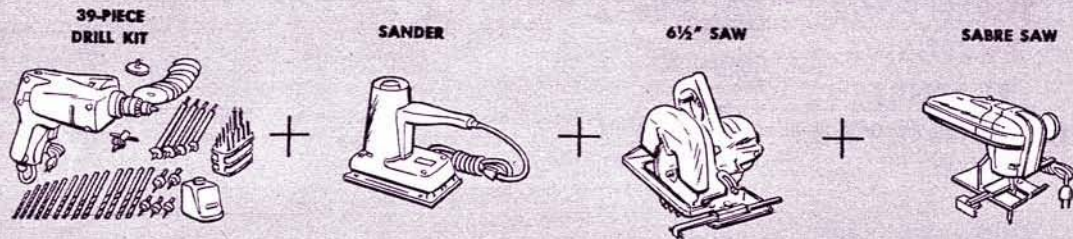

**\$5 DOWN
\$8 MONTHLY**
Buys all these POWR-KRAFT tools:

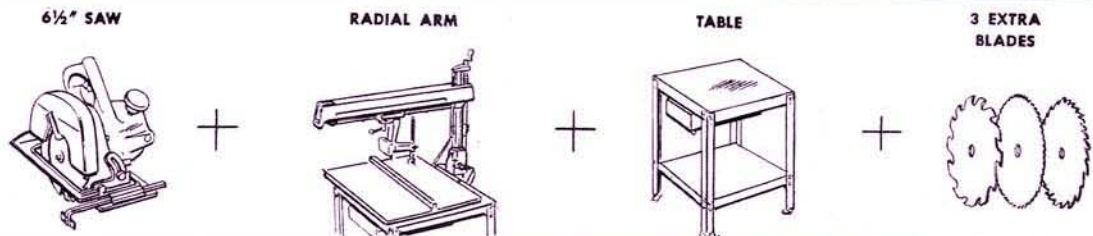

**\$10 DOWN
\$12 MONTHLY**
Buys all these POWR-KRAFT tools:

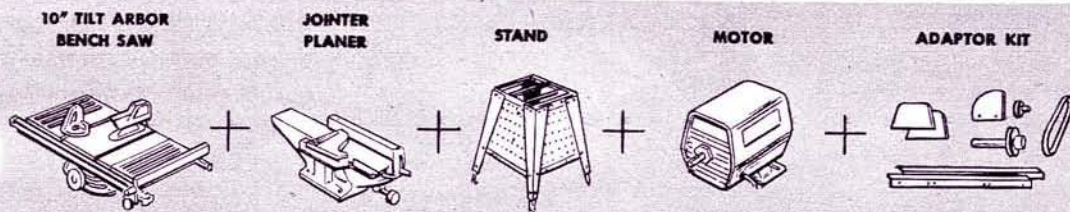

No other saws like *POWR-KRAFT*

POWR-KRAFT 10" tilt arbor bench saw

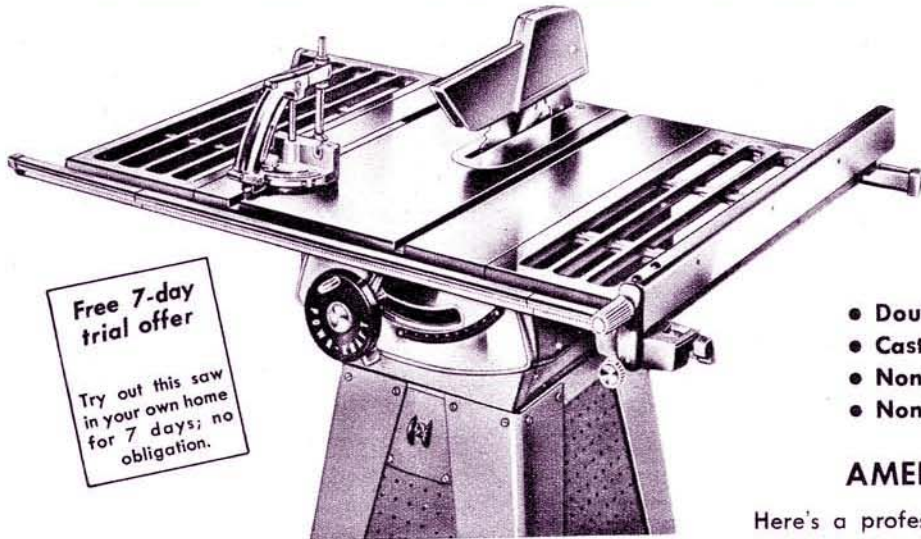

116⁹⁵
SAW ONLY
\$5 DOWN, \$6 A MONTH

Free 7-day trial offer
Try out this saw in your own home for 7 days; no obligation.

- Double-row ball-bearings, grease-sealed
- Cast-iron construction for longer life
- Non-snap table inserts for smooth feeding
- Non-clog tilt-and-raise mechanism

AMERICA'S FINEST 10" SAW

Here's a professional-quality 10" tilting arbor saw with exclusive features—plus features found only in higher-priced models! Plus a full one-year guarantee! Shop and compare! Price includes blade, motor mount, rip fence, miter gauge, double pulley, pair matched belts. 84 PE3333

***POWR-KRAFT* offers more plus features! Compare!**

COMPARISON CHART—10" SAWS	Brand "A"	Brand "B"	WARDS
Maximum depth cut	3 3/8"	3 1/8"	3 1/2"
1-inch depth of cut	1 5/4"	1 3/4"	1 5/8"
Non-Snap Insert	NO	NO	YES
Non-Clog Gears	SEMI	NO	YES
Single-Knob Control	NO	NO	YES

Complete saw outfit includes saw, 3/4 HP 3450 RPM motor, two table extensions, miter gauge pistol grip, saw guard, stand, pegboard panels, on-off switch 84 PE 2253 228.69. Motor only 83 PE 4547 37.95. Table extensions 84 PE 3334 each 13.98. Table insert for dadoes up to 1" thick 84 PE 3336 1.79. Table insert for molding cutters 84 PE 3337 1.79. Saw guard and splitter 84 PE 3335 11.98. Stand 84 PE 2937 14.50. Pegboard panels 84 PE 3390 set of four 4.95. On-off switch 84 PE 3381 4.45. Miter gauge pistol grip 84 PE 3444 9.95. Double groove V pulley with 3/4" arbor hole 84 PE 2879 1.25. Matched V belts 84 PE 2880 3/8 x 32" 1.58. Matched V belts 84 PE 2881 3/8 x 35" 1.65

Due to transportation costs, prices may vary slightly in certain areas.

SEE THESE FOUR EXCLUSIVE FEATURES DEMONSTRATED!



Dual belt drive delivers more HP to blade

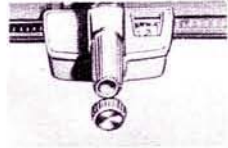

Rip fence locks down to table front and rear

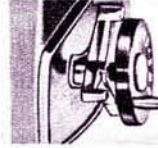

Single knob adjusts blade height and tilt

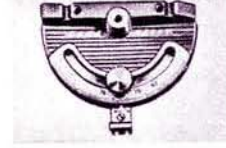

Miter gauge has built-in stop at 0° and 45°

Save time and money on Wards space-saver

255³¹
\$10 DOWN

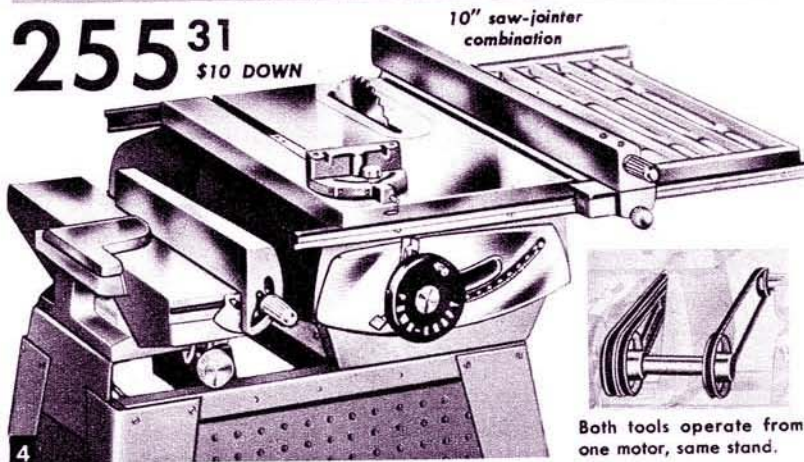

10" saw-jointer combination

A Ward exclusive! Operate both saw and jointer at the same time—use only one motor and one stand. Both tools operate simultaneously at any blade height. Because both tools are operated from the same motor, mounted on the same stand you save the price of an additional stand and motor. You save space and time, too, by having both tools in one compact unit. This new combination provides industrial precision and professional capacities—versatility and compactness so desirable in a home workshop. And it's fully guaranteed for one year, of course.

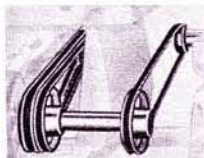

Both tools operate from one motor, same stand.

SEE IT DEMONSTRATED AT WARDS!

Compare features, prices. *POWR-KRAFT*

9" tilt arbor bench saw

79⁵⁰
SAW ONLY
\$5 DOWN

- 18% more cutting depth than other 9" saws
- Cuts to 3 1/4" depth at 90°, to 2 5/16" at 45°
- Double-row ball bearings lubricated for life
- Non-sag table insert for smooth feed of work

9" SAW WITH 10" CAPACITY

POWR-KRAFT 9" tilting arbor saw is built to industrial standards for long life, rugged service in professional or home workshops. Heavy-duty cast-iron construction reduces vibration for more accurate work. Has all the features (except dual belt drive) illustrated under 10" saw on opposite page. Its automotive-type ball bearings are permanently-sealed. Guaranteed one year. Let this POWR-KRAFT saw prove itself in your own home. Just try it yourself for 7 days. Price includes blade, motor mount, rip fence, miter gauge, pulleys, "V" belt. 84 PE 3486

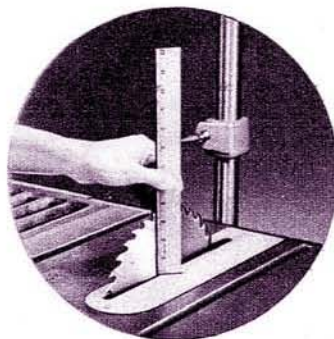

POWR-KRAFT 9" saw has as much cutting capacity as some 10" saws. Picture at left shows big 3 1/4" cut at 90° — will cut 2 5/16" depth at 45°. SEE IT DEMONSTRATED!

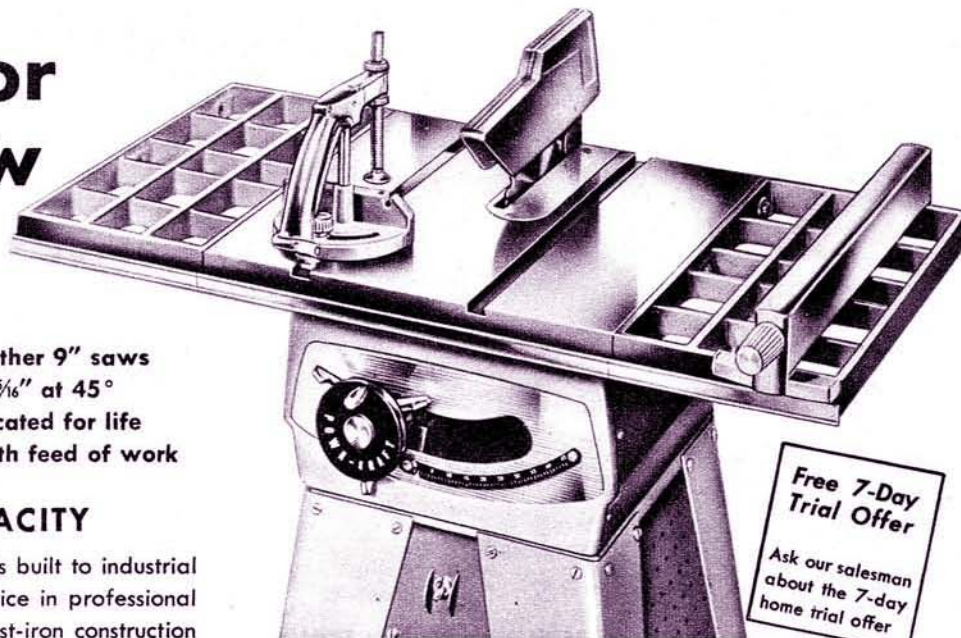

Free 7-Day
Trial Offer

Ask our salesman
about the 7-day
home trial offer

***POWR-KRAFT* offers more plus features! Compare!**

COMPARISON CHART—9" SAWS	Brand "A"	Brand "B"	WARDS
Depth of cut at 90°	3"	2 3/4"	3 1/4"
Depth of cut at 45°	2"	2"	2 5/16"
Non-Sag Insert	NO	NO	YES
Non-Clog Gears	NO	NO	YES
Single-Knob Control	YES	NO	YES

Complete saw outfit includes saw, 3/4" HP 1750 RPM motor, belt, pulleys, saw stand, on-off switch, peg-board panels, two table extensions, saw guard and miter gauge pistol grip 84 PE 3488 182.24. Motor only 83 PE 4543 37.95. Table insert for dadoes up to 1" thick 84 PE 3482 1.45. Table insert for molding cutters 84 PE 3483 1.45. Saw guard and splitter 84 PE 3491 6.98. Miter gauge pistol grip 84 PE 3444 9.95. Table extensions 84 PE 3478 each 11.98. Saw stand 84 PE 2937 14.50. Peg-board panels 84 PE 3390 set of four 4.95. On-off switch 84 PE 3381 4.45

Use your good credit at Wards. Pay as little as \$2 DOWN and \$5 a month.

Exclusive *POWR-KRAFT* saw-jointer combinations

- Choose either 9" or 10" bench saw in combination with 4" planer-jointer
- Save money—one stand, one motor to operate both tools at the same time
- Save space—both tools on one stand frees precious space for other tools
- Save time—tools operate simultaneously, cut wood on saw, finish it on jointer

10" SAW-JOINTER COMBINATION

Here's the only 10" saw-jointer combination that lets you switch power from one tool to the other without the work and delay of moving motor. There's no sacrifice of operational features or capacities of either tool. Includes 10" tilting arbor bench saw, 4" jointer-planer (see page 6); stand, saw-jointer adaptor kit, table extension, 3/4 HP motor 84 PE 3305 255.31. Saw-jointer adaptor kit converts 10" saw and 4" jointer as combination 84 PE 3339 16.98. Peg-board panels. Set of 4 84 PE 3391.....6.95

9" SAW-JOINTER COMBINATION

If the 9" model best suits your needs ask Wards salesman to arrange for a free home-trial demonstration. Prove to yourself that this is the finest tool of its kind. Comes complete with everything you need to start your projects. Includes 9" tilting arbor bench saw, 4" jointer-planer (see page 6); stand, saw-jointer adaptor kit, table extension, 3/4 HP motor 84 PE 3497 214.86. Saw-jointer adaptor kit. Converts 9" saw and 4" jointer as combination 84 PE 3349 15.98. Peg-board panels. Set of 4 84 PE 3391.....6.95 **5**

Outperforms others at this price!

POWR-KRAFT 8" tilting arbor bench saw

55⁵⁰
SAW ONLY
\$5 DOWN

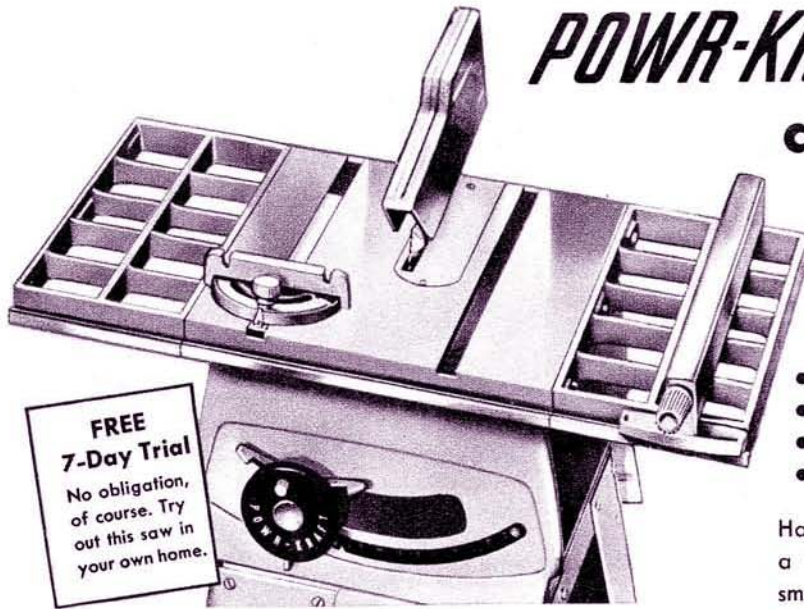

- Positive tilt-lock holds blade rigid
- Double-row ball bearings; grease-sealed
- Self-squaring rip fence; one-knob control
- 14 x 17" table area; adequate for most jobs

Has many expensive features. Extra capacity—cuts a finished 2 x 4. Non-sag table insert provides smooth feeding of workpiece. Motor mount is hinged. Guaranteed one year. Includes motor mount, miter gauge, rip fence. 84 PE 3331

Complete Saw Outfit includes 8" saw, saw stand, 2 table extensions, guard, motor pulley, "V" belt, 1/2-hp motor. 84 PE 2251 127.12. Motor Only 83PE4545 32.95. Table Extension 84PE 3343 each 7.75. Saw Guard and Splitter 84 PE 3342 6.98. Table Insert for dados up to 1" thick 84 PE 3340 1.35. Table Insert for molding cutter head 84 PE 3341 1.35. Saw Stand 84 PE 2937 14.50. 3/8" x 36" "V" Belt 84 PE 2875 74c. Motor Pulley 4" diameter 84 PE 2878 95c. Pegboard Panels for Stand 84 PE 3390 4.95. Safety Switch 84 PE 3381 4.45. Casters 84 PE 3379 Set of two 1.25

FREE 7-Day Trial
No obligation, of course. Try out this saw in your own home.

POWR-KRAFT OFFERS MORE PLUS FEATURES: COMPARE!

COMPARISON—FAMOUS 8" SAWS	Brand "A"	Brand "B"	WARDS
Maximum depth of cut	2 1/2"	2 1/4"	2 1/2"
Table in front of blade	8 1/2"	7 1/8"	8 1/2"
Non-sag insert	No	No	YES
Non-clog gears	No	No	YES
One-knob control	No	No	YES
Cast-iron carriage	No	YES	YES

Professional quality—TWO safety-tapered blades with micro-adjustment insure accuracy

POWR-KRAFT 4" jointer-planer

54⁹⁵
\$5 DOWN

Its safety-tapered blades are micro-adjustable for greater accuracy. Runs smoothly on grease-sealed ball bearings—never need oiling. Rugged cast-iron base minimizes vibration. Rigid fence construction. Guard covers blades—springs back after each cut. Full one-year guarantee. 84 PE 2514

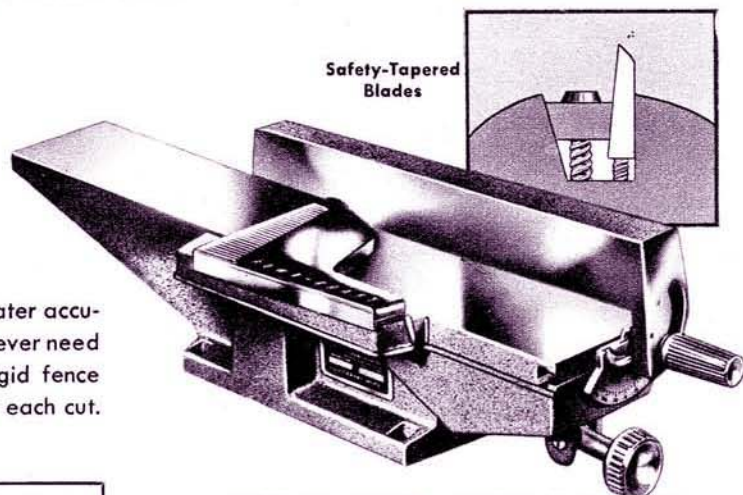

Safety-Tapered Blades

TRY IT FREE—FOR 7 DAYS!

Complete Outfit. Includes Jointer-Planer, 1/2-hp Motor, Belt, Motor Pulley and Stand. 84 PE 2501 98.66. Motor Only 83 PE 4501 21.75. 5" Pulley 84 PE 2878 1.10. 3/8" x 43" "V" Belt 84 PE 2875 88c. Stand 84 PE 2935 19.98. Safety Switch 84 PE 3381 4.45. Casters 84 PE 3379 set of two 1.25. Pegboard Panels for Stand 84 PE 3373 set of 4 5.50. Extra Cutter Blades. Safety-tapered tool steel blades for Jointer 84 PE 2521 set of two 3.98

COMPARISON—FAMOUS 4" JOINTERS	Brand "A"	Brand "B"	WARDS
Cutter head width	4 1/8"	4"	4"
Maximum depth cut	3/8"	1/4"	3/8"
Safety tapered knives	No	No	YES
Micro-adjustment	No	No	YES
1-pc. fence construction	No	No	YES
Grease-sealed ball bearings	No	No	YES

Due to transportation costs, prices may vary in certain areas.

POWER-KRAFT 12½ inch drill press

62⁵⁰
\$5 DOWN

BENCH MODEL

- Precision-sealed ball bearing spindle
- Exclusive safety head support, cannot drop
- Cast-iron head rides on tubular steel column
- Spindle guaranteed accurate to .005 inch

No other drill press in this price range includes so many plus features. Exclusive quick-cam motor mount for faster speed change and automatic belt tension. Permits easy adjustment of four spindle speeds (note view at top, right). Exclusive safety head support. Head swings 360° but cannot drop; allows for floor-type drilling. Big capacity—drills to center of 12½" circle. 3-inch feed with quill lock. 18" chuck to bench. Price includes ½" Jacobs geared chuck; also 4-step machine and motor pulleys. 84 PE 2525.

Complete drill press outfit includes 12½" drill press, ⅓-hp motor, tool stand, motor pulley and belt. 84 PE 2527.....105.02
⅓-hp motor only, 83 PE 4501 21.75. Stand 84 PE 2935 19.98.
4-step motor pulley 84 PE 2895 1.85. V-belt ½" x 37" 84 PE 2876 79c. Pegboard panels for stand 84 PE 3373 5.50. Safety switch 84 PE 3381 4.45. Casters 84 PE 3379 set of two 1.25.

POWER-KRAFT OFFERS MORE PLUS FEATURES SHOP AND COMPARE

COMPARISON FAMOUS DRILL PRESSES	Brand "A"	WARDS
Drills to center of circle	12¼"	12½"
Large 8" x 8" table size	No	YES
Spindle stroke	3"	3"
Safety head support	No	YES
Dial-type indicator and stop	No	YES
Reverse tapered spindle tip	No	YES
Quick-cam motor mount	No	YES
Bearings	Bronze	Ball

Exclusive features! Compare!

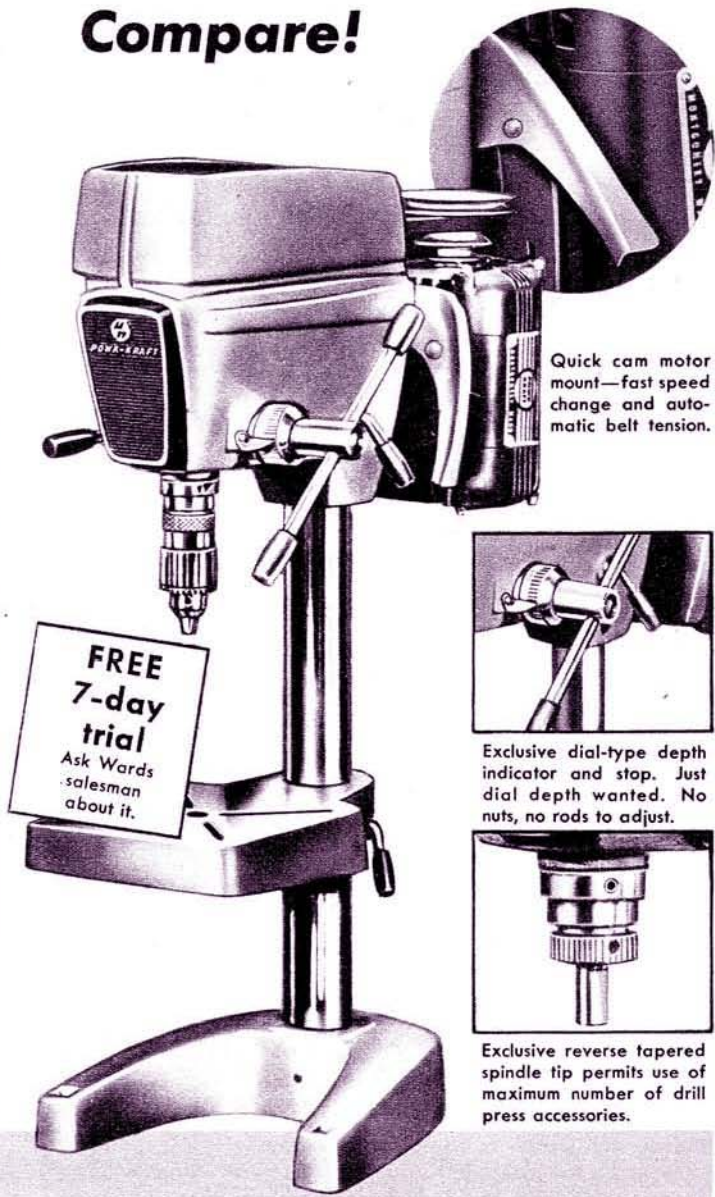

Quick cam motor mount—fast speed change and automatic belt tension.

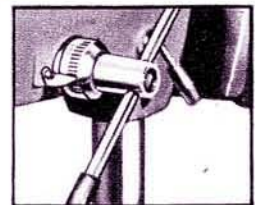

Exclusive dial-type depth indicator and stop. Just dial depth wanted. No nuts, no rods to adjust.



Exclusive reverse tapered spindle tip permits use of maximum number of drill press accessories.

DRILL PRESS ACCESSORIES

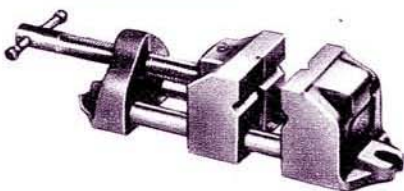

Drill press vise gives quick set-ups without the use of clamps. Holds small articles or pieces when drilling; just bolt to drill press table. Ideal for home workshop. Rugged cast-iron. 84 PE 2563...4.75



Hole cutter accurately cuts round holes ⅞ to 4" dia. in steel, wood, plastic. Fits drill press, bit braces. 84 PE 3656...2.19. **Extra Blade** 84 PE 3657...59c



(A) **Magna shaper cutters.** ½" bore. Use on drill presses, shapers or Shopsmith (views above show profiles available). Proper heel clearance prevents burning; eliminates drag. 1" width cut; 1¾" dia. 84 PE 3138 ea. 2.45

(B) **Magna shaper collars.** ½" bore. Set of 4. Assorted sizes. 84 PE 3139.....2.25

(C) **Magna dropleaf table shaper cutter set.** ½" bore. 1 for dropleaf, 1 for table. 84 PE 3141.....set 4.95

Build while you pay. Pay \$2 to \$5 DOWN, as little as \$5 a month.

Larger capacity than ordinary lathes

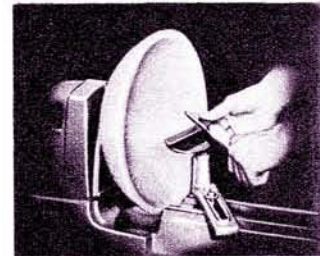

Allows full 12" swing over 4" of gap bed. Lets you turn out big bowls, plates. A plus feature!

POWR-KRAFT 30" wood lathe

Compare with lathes priced \$10 higher! Built to most rigid "specifications" for life-time service. Massive one-piece cast-iron bed. Reverse tapered spindle takes any Magna lathe accessory. Built-in grinding wheel keeps your chisels sharp. One-year guarantee. 84 PE 2020.....42.95

- Ball bearings—grease-sealed
- 12-inch Swing over gap bed
- 9-inch Swing over ways
- Has built-in grinding wheel

Complete lathe, 1/3 HP motor, stand, 4 step pulley, 1/2 x 52" belt. 84 PE 2023....84.93

42⁹⁵
Lathe Only

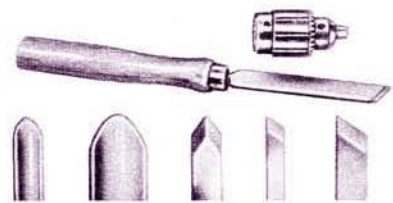

Jacobs chuck to fit POWR-KRAFT lathe 3/4—1/2-in. cap. Fits 3/8" unthreaded spindles. 84 PE 2027.....9.00
Woodturning chisel set 1/2", 3/4" gouges, 1/4", 1/2" skewers; also parting tool. Keen-edged, crucible steel 4" blades. Hard-wood handles, approximately 8" long. 84 PE 2052 5-pc. set.....6.50

Motor 1/3 HP 83 PE 4504 17.98. Stand 84 PE 2936 22.95. 12" Sanding Disc 84 PE 2977 5.95. 12" Sanding Sheets 84 PE 2010 Fine, Med., Coarse or Ass'td grits. Pkg. of 6 1.79. Peg Board Panels 84 PE 3374 Set 6.95. Casters 84 PE 3379 Set 1.25. Switch 84 PE 3381 4.45.

LATHE "COMPARISON"	Brand "A"	WARDS
Priced under \$50	NO	YES
Face-plate capacity	12"	12"
Reverse tapered spindle	NO	YES
Built-in grinding wheel	NO	YES
Wide range of spindle speeds: 800-3800 rpm	NO	YES

Due to transportation costs, prices may vary slightly in certain areas

Handles home workshop jobs quickly, easily

POWR-KRAFT 4" belt sander

- Contour sand on big 2 1/4" diam. drums
- Fence tilts to 45°; removes easily
- Has adjustable sanding belt tension

19⁹⁸

FREE 7-DAY TRIAL
Ask about this free offer at Wards

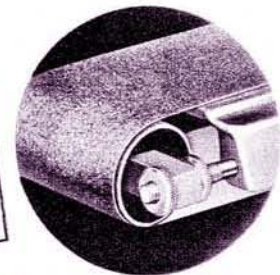

Precision tracking keeps belt from riding off drums. Surface sand large pieces with fence removed. Fence adjusts for angle sanding up to 45°. Rigid cast-iron construction. Full one-year guarantee. With med. grit 4 x 36" sanding belt. 84 PE 2705

Motor 1/3 HP 83 PE 4504 17.98. Stand 84 PE 2935 19.98. Casters 84 PE 3379 1.25. Peg-board panels 84 PE 3373 set of 4, 5.50; Switch 84 PE 3381 4.45

Complete sander outfit includes sander, 1/3 HP motor, stand, 3/8 x 38" belt, 2" diam. motor, pulley. 84 PE 2707 59.32
Endless sanding belt aluminum oxide abrasive on cloth. For wood, metal or plastic. Choice of fine, medium or coarse grit. 4" wide, 36" circumference. Fits sander above. 84 PE 2729.....2 for 1.50

Use your good credit at Wards. Pay as little as \$2 DOWN and \$5 a month.

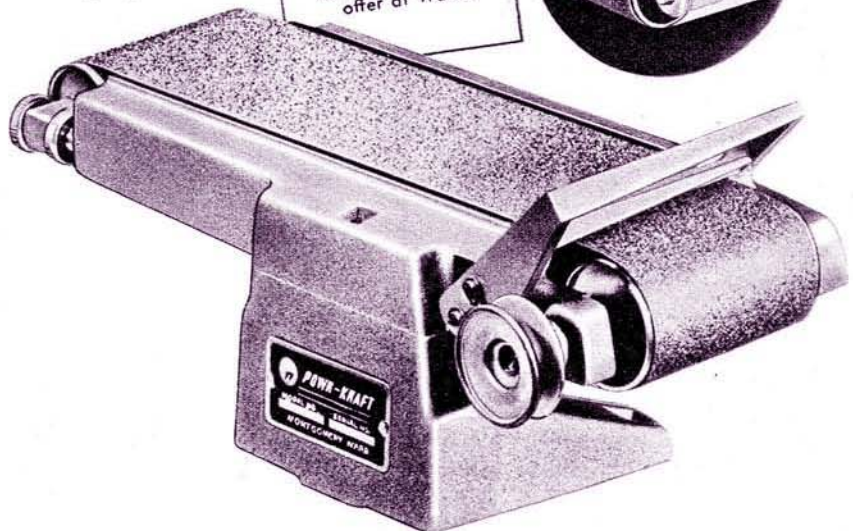

Compare with
\$39 jig saws!

Engineered like
industrial models!



Remove arm; it's a sabre saw!

22⁹⁵
POWR-KRAFT 12 1/2" jig saw

- Roomy 12 1/2" throat, full 1 1/2" depth of cut
- Has rotating chucks (to 90°) for long rips
- Doubles as a machine for filing metal, wood

Has features and quality of \$39 jig saws! Table tilts to 45°. Built-in blower keeps workpiece clear of sawdust. Chucks rotate for side or front sawing. Driving mechanism is lubricated for life. With plain end blade. 84 PE 2392.

Motor 1/4 HP 83 PE 4503 16.49; Stand 84 PE 2935 19.98; Casters 84 PE 3379 1.25; Peg-Board Panels 84 PE 3373 set 5.50; Switch 84 PE 3381 4.45

Complete outfit includes POWR-KRAFT jig saw, 1/4 HP motor, 1 stand, 2" diam. motor pulley, and 3/8 x 42" belt. 84 PE 2394 60.88. **A** Sabre saw blade Ass't. 84 PE 2386 12 for 98c. **B** Plain end jig saw blades 10 or 15 tooth 84 PE 2378 6 for 45c. Plain end jig saw blades for general use. Assortment. 84 PE 2382 12 for 79c

POWR-KRAFT JIG SAW HAS MORE PLUS FEATURES! COMPARE!

	Brand "A" WARDS		Brand "A" WARDS	
Throat depth	12"	12 1/2"	Depth of cut	1" 1 1/2"
Blower on line	NO	YES	Removable Arm	NO YES
Rotating Chucks	NO	YES	Lubricated-for-life	NO YES

**NEW
DREMEL
MOTO-SHOP
33⁹⁵**

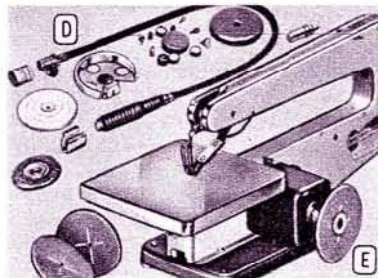

D Accessory Kit for Dremel Moto-Shop — contains grinding wheel, cloth wheel, wire wheel, wheel guard, adaptor, polishing compound, 12-pc. accessory set, flexible shaft. 84 PE 2373.....19.95

E Combination jig saw-disc sander. With ball bearing rotary type enclosed motor. 15" jig saw plus power take-off and disc-sander attachment. With 3 sanding discs, 4 blades. 84 PE 2372.33.95
3" Pin-End blades for above. 84 PE 2399.....12 for 60c



Table Tilts 45°

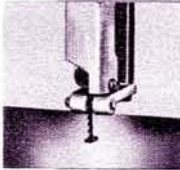

Adjustable Guides

7-DAY FREE TRIAL
Take advantage of this 7-day home-trial offer now!

POWR-KRAFT 9" band saw
ONE-PIECE CAST-IRON FRAME—RUGGED, RIGID **58⁵⁰**

\$5 DOWN

- Permanently-lubricated ball bearings
- One-piece cover for fast, easy blade change
- Cuts through wood up to 4 inches thick
- Cuts to the center of an 18-inch circle

Frame and back cover of cast-iron in one rigid piece to minimize vibration. Has oversize tracking and tensioning knobs for easy adjustment. Table tilts up to 45° on twin slide trunnion—locks in any position. Guaranteed one full year. With 60" x 1/4" blade. 84 PE 2325.....58.50
Motor 1/2 HP 83 PE 4504 17.98; Stand 84 PE 2935 19.98; Casters 84 PE 3379 1.25. Peg-Board Panels 84 PE 3373 set of 4 5.50; Switch 84 PE 3381 4.45. Complete band saw outfit includes band saw, 1/2 HP motor, stand, 3/8" x 45" belt, 2" motor pulley, 84 PE 2327 97.97

C Endless wood-cutting band saw blades. Choice of 1/8, 3/16, 1/4 or 3/8 in. widths. 60" long. Fit above band saw. 84 PE 2330.....each 1.25

Endless band saw blades for Magna band saw (#3357 on page 15) 1/8, 1/4, 3/8" for woodcutting, 1/2" for wood or metal. 84 PE 2334 1/8 x 72" 1.50. 1/4 x 72" 1.50. 3/8 x 72" 1.50. 1/2 x 72" 1.50

Band saw blades by the foot. Woodcutting. Welded and made endless to any length. See Catalog Dept. in the Store for selling prices. 84 PE 2331.

COMPARE POWR-KRAFT SPECIFICATIONS—COMPARE PRICE

Capacity of throat.....	9 inches
Depth of cut.....	4 inches
Table size.....	10" x 10" with 45° tilt
Blade length (one 1/4" width included).....	60 inches
Takes blade width.....	1/8, 3/16, 1/4 and 3/8 inches

Krome-A-Loy blades last longer!

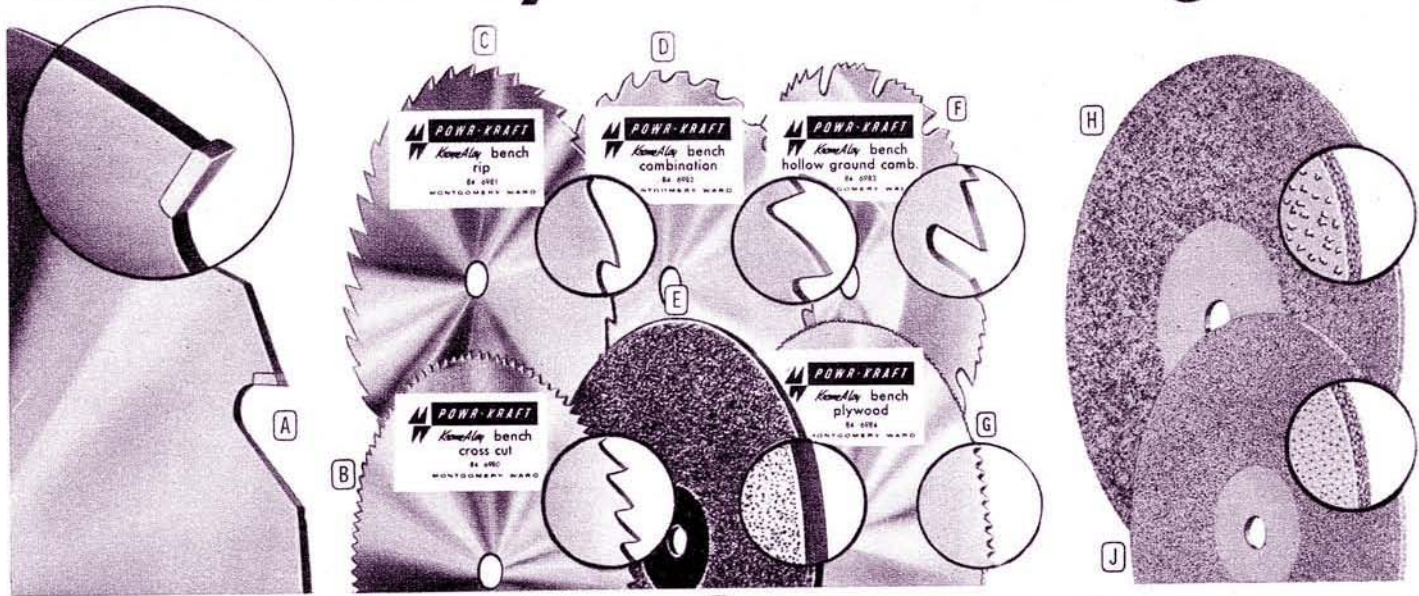

A POWR-KRAFT carbide-tipped blades last 25 times longer than ordinary blades! Hard-chrome plating goes deep into edges of teeth and gullets where cutting is done. Tungsten-carbide tips silver brazed to blades and finish-ground on diamond wheel to exact tolerances for faster, smoother, more efficient cutting. Cut hardwood, plastics, roofing, siding, etc. 1/2" or 3/8" arbor. 84 PE 6986 8" diam. 10.50

B C D POWR-KRAFT flat ground saw blades. New chrome vanadium steel, tempered and hardened. Precision filed, set by hand for perfect blade alignment. Chrome plated finish—won't bind. Choice: 3 types of teeth.

Diam.	Ga.	Fits			84 PE 6982
		Hole Size	(B) Cross cut	(C) Rip	
6"	18	1/2" or 3/8"	—	—	\$1.98
7"	18	1/2" or 3/8"	\$2.25	\$2.25	2.25
8"	18	1/2" or 3/8"	2.39	2.39	2.39
9"	18	1/2" or 3/8"	3.59	3.59	3.59
10"	16	3/8" or 3/4"	3.59	3.59	3.59
12"	14	3/4" or 1"	—	—	4.69

E Steel sanding wheel converts bench saw into disc sander. Fits 1/2 or 3/8-inch diameter arbors. Comes with one medium, one coarse, disc. 84 PE 2285 2.95. Extra discs, assorted grits. 84 PE 2286. Five for 75c

F POWR-KRAFT hollow ground combination blades. There's less friction; blade runs faster, longer without heating. Teeth are not set because blade is tapered (from 17 to 14 gauge) from edge to center to provide clearance at sides. Cuts sharpening time. Narrower kerf means cleaner, more accurate cuts. No after-planing or sanding necessary: Chrome vanadium steel. Fit holes sizes 1/2" or 3/8" except 10" which fits 3/8" or 3/4". 84 PE 6983 7" diam. 3.59. 8" diam. 4.49. 9" diam. 8.50. 10" diam. 8.50

G POWR-KRAFT plywood blades minimize splintering. Use also to cut wallboard, flooring, plastics, fine finish work. 84 PE 6984

Diam.	Gauge	No. Teeth	Fits hole size	Price
7"	20	200	1/2" or 3/8"	\$2.25
8"	20	250	1/2" or 3/8"	2.39
9"	20	250	1/2" or 3/8"	3.59
10"	20	300	3/8" or 3/4"	3.59

H J Carbide-tungsten cutting and sanding blade. Completely new! Versatile! Not only rips and crosscuts, but sands material at the same time! Use also to miter, plough, notch, groove or face sand! No teeth: tungsten carbide particles copper-brazed to edges, sides cut, sand like magic!

H 8" diam., 1/2" and 3/8" arbor for bench saws. 84 PE 4103. 7.50
J 6 1/2" diam. 1/2" round arbor for portable saws. 84 PE 4104. 5.49

Get your power transmission equipment at Wards

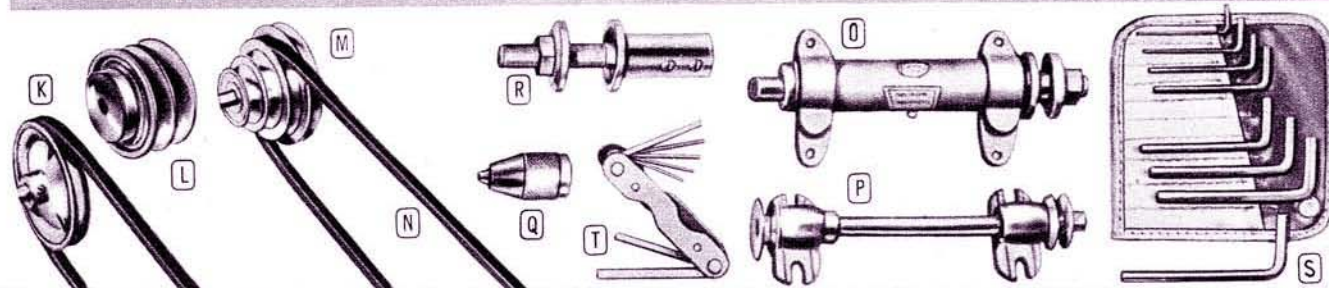

K Single groove die cast "V" Pulleys for 3/8 or 1/2-inch width "V" Belts. 5" and 6" sizes come in spoke design; others, as illustrated. 84 PE 2878

Diam.	Bore, inches	Price	Diam.	Bore, inches	Price
1 1/2"	1/2" or 3/8"	49c	4"	1/2", 3/8" or 3/4"	98c
2"	1/2" or 3/8"	65c	5"	1/2", 3/8" or 3/4"	\$1.15
2 1/2"	1/2", 3/8" or 3/4"	69c	6"	1/2", 3/8" or 3/4"	1.49
3"	1/2", 3/8" or 3/4"	79c			

L Double groove "V" pulley 3/4" arbor hole, for 3/8 or 1/2-in. width "V" belts. (Fits 10" POWR-KRAFT Saw #3333 on page 4). 84 PE 2879 1.25

M Four-step "V" pulley 4 1/8, 3 3/8, 2 3/8, 1 7/8-inch diameter steps. Comes in 1/2 and 3/8-inch diameter bores. 84 PE 2895 1.85

N Rubber "V" belts. "A" section type, 1/2" width. 84 PE 2876

20" .65c	28" .69c	35" .79c	40" .89c	46" \$1.00	53" \$1.09
22" .65c	30" .69c	36" .85c	41" .89c	48" 1.00	54" 1.15
24" .65c	31" .69c	37" .85c	42" .98c	50" 1.00	56" 1.19
25" .65c	32" .79c	38" .85c	44" .98c	51" 1.05	58" 1.25
26" .65c	34" .79c	39" .89c	45" \$1.00	52" 1.05	60" 1.25

O Rubber "V" Belts "O" section type 3/8" width 84 PE 2875
 32".75c 33".75c 34".75c 35".75c 36".79c 38".79c 39".85c
 40".85c 41".85c 42".89c 43".89c 44".89c 45".98c 49".98c

P High speed saw mandrel 84 PE 7005 Shaft diameters: 1/2" by 9 1/2" long. 6.79. 3/8" by 10" long. 7.50. 3/4" by 12" long. 9.50

Q Light duty saw mandrel 84 PE 7010 Shaft diameters 3/8 inches; threaded 1/2", 13" long. 4.39. 3/4", threaded 3/8" 14" long. 5.19

R 3-jaw chucks fit 1/2-in. 24-thread spindles. 84 PE 2764
 1/4-inch capacity. 95c 1/2-inch capacity. 1.35

S Motor arbors 1/2-inch 24-thread spindle. Fits 1/2-inch motor shaft 84 PE 2915. 1.39. Fit 3/8-inch motor shaft. 84 PE 2916. 1.50

T Socket key sets (of 8) Regular length fit Allen type #5 to 1/2" set screws, #4 to 3/16" cap screws. 84 PE 2901. set 75c. Extra long Fits #8 to 3/8" set screws, #3 to 3/16" cap screws. 84 PE 2902 set. 1.15

U Folding socket key set. 7 most-used sizes. 84 PE 2903. 1.25

Due to transportation costs, prices may vary in certain areas.

Get more uses out of your bench saw!

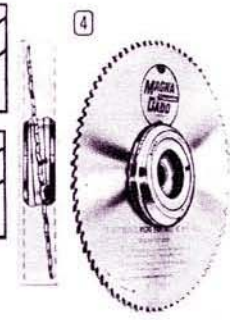
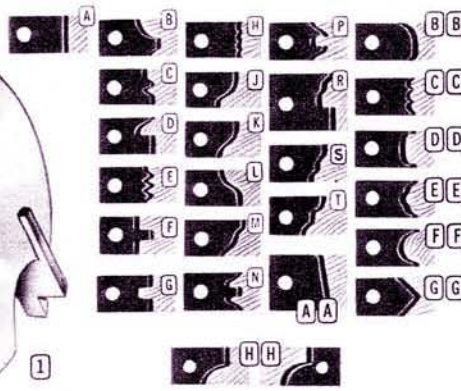

Molding cutter heads for unlimited cuts!

Do the work of a shaper or jointer-planer with the bench saw or Shopsmith you now have. Trim your own stock and save on high lumber costs. Prepare tongue-and-groove flooring, picture frames, building trim.

1 POWR-KRAFT molding cutter head fits most saws with 1/2" or 3/8" diam. arbor. 3 3/8" diam., 7/8" wide. (Use with knives at right.) 84PE2267.....4.95

Magna molding cutter head (not shown). Fits Shopsmith Mark 2 or Mark 5. Alloy steel. 3 3/8" diam., 7/8" wide. 84 PE 3102.....7.95

H H POWR-KRAFT drop leaf table molding cutter set. Fits heads above. Complete with one cutter set for dropleaf, one for table edge. 84 PE 2256.....6.39

A to **GG** POWR-KRAFT knives (listed at right). Use with molding cutter heads described above. High grade tool steel. Have correct angle for true shaving cut. Several sets can cut unlimited variety of shapes. Each set includes 3 blades of one shape. Align perfectly, won't slip. 84 PE 2255

MOLDING HEAD KNIVES

Profile and description	Per Set
A Blank square knives.....	2.98
B 1/4, 1/2, quarter round.....	2.98
C Glue joint, 1/2", up.....	2.98
D Cabinet door lip 3/4".....	2.98
E V flute molding.....	2.98
F Groove.....	2.98
G Tongue.....	2.98
H 4-bead molding.....	2.98
J O. G. molding.....	2.98
K O. G. molding.....	2.98
L O. G. molding.....	2.98
M Reverse O. G.....	2.98
N Panel insert.....	4.39
P Panel insert cope.....	4.39
R 1 3/4" sash.....	4.39
S 1 3/8" sash cope.....	4.39
T Bead, cove molding.....	2.98
AA Panel raiser.....	4.39
BB 1/4, 1/2 cove.....	2.98
CC 3 bead.....	2.98
DD Screen molding.....	2.98
EE Screen molding.....	2.98
FF 3/4" half round.....	2.98
GG 45° vee.....	2.98

Versatile dado heads!

Here's another way to multiply the usefulness of your bench saw at low cost. Do your own dadoing, notching, grooving; make professional-quality joints for cabinets, bookcases, shelves, etc.

2 Professional quality dado heads. Hard chrome-plated outside blades retain cutting edge longer. Tempered alloy steel. Two outside blades 1/8" thick, four chippers (one 1/8, two 1/8", one 1/4 in.) Diam. Arbor Hole Catalog No. Price
6" 3/8" 84 PE 2283 9.95

3 Hobbyists' quality dado head of stamped steel. Set includes two 1/8" outside blades, three 1/8" chippers and one 1/8" chipper. 5" diameter blades have 3/8" arbor hole. 84 PE 2293.....set 5.50

4 Magna heavy-duty dado assembly fits Shopsmith or POWR-KRAFT bench saws. Wobble type. Precision outfit for fast accurate work. Calibrated dial with Allen wrench for desired cut from 1/32" to 7/8" wide, up to 2" deep. 8" blade, 3/8" or 3/4" arbor hole. 84 PE 3300.....15.95

Wards—headquarters for your woodworking needs



5 POWR-KRAFT quick-acting heavy-duty woodworking vise. Width of jaws 9"; depth 3 3/8". Opens to full 10". Cast-iron jaws have resinwood faces. Two stops in front jaw. 84 PE 3186.....15.95

6 POWR-KRAFT medium-duty woodworkers' vise. Continuous 3/8" diam. screw. 7" cast iron jaws; 3 1/4" deep, opens to 7". 84 PE 3185. 8.50

7 Light duty vise with 3/8" diam. continuous screw. Jaws 6 1/2" wide; open to 4 1/2". 84 PE 3159. 4.45

8 Miter vise and corner clamp. Holds work at 60°, 90°, 180°. Opens to 3". 84 PE 3175. 1.39

9 Sawhorse brackets. Use with 2x4s. No miter cuts needed. 84 PE 2970pair 1.89

10 All Steel folding saw horse. Supports up to 450-lbs. 42"x23" high. 84 PE 2974. ea. 5.95

11 Dowel centers for perfectly centered joints without measuring. Accurate and time-savings. Two each of 1/4, 3/8 and 1/2-inch sizes. In plastic box. 84 PE 3177..... set 95c

12 Weldwood powdered resin glue. Mix with water. Stain-free. For wood to wood bonds. 84 PE 3174 8-oz. can.....75c

13 White liquid glue. For bonding paper, ceramics, wood, etc. 84 PE 3170 4-oz.55c

14 Pipe bar gluing clamp. Malleable iron. Use with any length of 3/4" threaded pipe. Hand crank adjusts to 3". 84 PE 3151.....ea. 2.69

15 Jorgenson "extended" clutch-disc bar clamps. Adjustable clamp grips 1/4x3/4-in. bar at any point. Releases easily. Won't slip. Jaw reach of 2 1/2" from edge of bar to center of screw. Maple handle. 84 PE 3155. Opening 6" 2.15 12" Opening.....2.45

16 Malleable iron "C" clamps. Self-adjusting swivel head. 84 PE 3160 1" x 1" deep.....29c 2" x 1" deep.....35c 3" x 2" deep.....98c 4" x 3" deep.....1.45 6" x 3 1/2" deep.....1.85

17 Aluminum alloy "C" clamps. Strong, lightweight, rust-proof. Perfect for model and pattern makers. 84 PE 3167 1" x 1" deep.....39c 2" x 1".....55c. 3" x 2".....1.15. 4" x 3".....1.65

Wards **POWR-KRAFT** electric motors

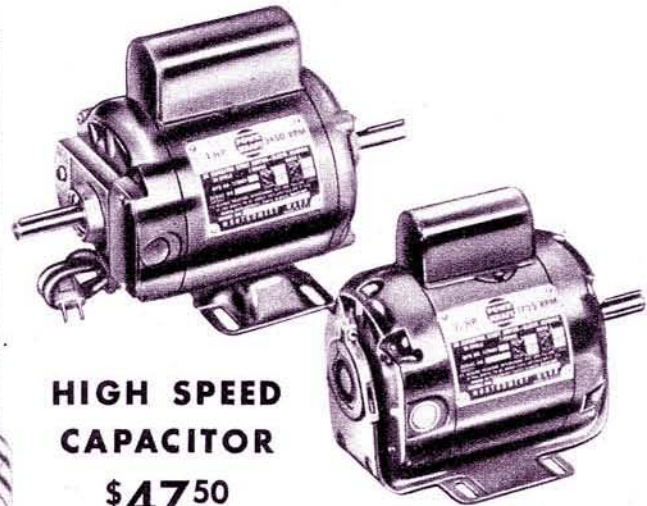
HIGH SPEED CAPACITOR

\$47.50
1-hp

For medium to hard-starting loads in factories, mills, on compressors, large saws, etc. Built-in Thermoguard® manual overload protector and grease-sealed ball bearings. Slotted 3 x 4 7/8" mounting base, 8' cord and plug, 115-230V 60 cycle AC, 3450 RPM. 1-hp 5/8" keyed shaft. 83 PE 4598 . . . **47.50**
1 1/2-HP 3/4" keyed shaft. Mount dimensions 5" x 5 7/8". Like 4580. 83 PE 4599 . . . **68.75**

GENERAL PURPOSE CAPACITOR

\$24.75
1/2-hp

High starting torque for stokers, pumps, refrigerators, power tools. Cradle type base—mounting dimensions 3 x 4 7/8"—mounts at any angle. Precision sleeve bearings and NYLON thrust bearing. 5/8" keyed single shaft, 1750 RPM motor, 115V 60 cycle AC current, 1/2 HP. 83 PE 4567 . . . **24.75**
3/4 HP heavy-duty motor. Rigid base, double shaft. 83 PE 4543 . . . **37.95**

NEWLY-DESIGNED!

MORE COMPACT! LESS WEIGHT!

POWR-KRAFT 100 Capacitors

Smaller in design, yet greater in efficiency—lighter in weight, yet better performing. All because POWR-KRAFT uses the newest materials! 8 times stronger Mylar insulation gives 35 times greater moisture protection. Grease packed and permanently sealed ball bearings never need care! Thermoguard® manual overload protection. Built in starting switch assures instant starting, years of quiet, trouble-free service. Slotted mounting base 2 3/4" x 4 1/4". 5/8" diameter keyed double shaft, 8' cord and plug. Runs cooler, lasts longer because of "straight-through-ventilation". Easily reversed. 115 Volt 60 cycle AC.

1/4-hp—1750 RPM 83 PE 4545	32.95
1/2-hp—3450 RPM 83 PE 4546	32.95
3/4-hp—3450 RPM 83 PE 4547	37.95

Due to transportation costs, prices may vary in certain areas.

POWR-KRAFT split-phase motors run

QUIETER, EASIER TO REVERSE!

- Mylar insulation gives 35 times greater moisture resistance, 8 times stronger than usual insulation
- "Straight-through-ventilation"—cooler-running
- Push-pull leads for instant change of rotation

All new—develops two times rated-power for starting. Heavy-gauge steel frame. Vibrationless micro-ground shaft. Continuous duty. 1-year guarantee. 115V 60 cycle AC. Mounting dimensions 2 3/4 x 4 1/4-in. 8 ft. cord and plug.

Nylon thrust sleeve bearing models with single 1/2"-diameter flat shaft. 1/4-hp 83 PE 4503 **16.49** 1/2-hp 83 PE 4504 **17.98**
1/2-hp Ball Bearing Model grease-packed and 4-way sealed at factory—never needs lubrication. 1/2" flat double shaft. 83 PE 4501 **21.75**

SEE THEM DEMONSTRATED AT WARDS



for top performance and power



POWR-KRAFT heavy-duty repulsion-induction motors

(A) (B) POWR-KRAFT Heavy Duty. For hardest-starting jobs—heavy production tools, freezers, refrigerators, compressors, hammermills, water pumps, etc. Also for severe climates or where heavily-loaded circuits cause low voltage. Low starting current—develops 4 to 5 times rated torque for starting and emergencies. Heavy copper, wound, balanced armature. Four brushes, fan cooling. Reversible. Single keyway shaft. 1725 RPM. Continuous duty.

(A) Motors with oversize steel-backed babbitt sleeve bearings. Diamond-bored. Use in horizontal position only. Large oil reservoir. Brush lifting mechanism. $\frac{3}{4}$ " shaft extends $2\frac{1}{4}$ ". Mounting dimensions: $5 \times 5\frac{7}{8}$ " 83 PE 4612..... $\frac{1}{2}$ -HP..... 49.00. $\frac{3}{4}$ -HP..... 65.00

(B) Motors with pre-lubricated, oversize ball bearings. For extra-quiet operation. Can be used in any position. 83 PE 4640. 1-HP $\frac{7}{8}$ " shaft diameter extends to 2". Mounting dimensions $4\frac{1}{2} \times 7\frac{1}{2}$ "... 92.00. $1\frac{1}{2}$ -HP $\frac{7}{8}$ " shaft diameter extends to 2". Mounting dimensions $5\frac{1}{2} \times 7\frac{1}{2}$ " 121.00. 2-HP $1\frac{1}{8}$ " shaft diameter extends to $2\frac{3}{4}$ ". Mounting dimensions $5\frac{1}{2} \times 8\frac{1}{2}$ " 158.00

6 REASONS WHY POWR-KRAFT MOTORS ARE YOUR BEST BUY!

1. Heavy-gauge frame protects windings, core—prolongs motor life, keeps bearings aligned
2. "Formvar" insulated windings with baked-on varnish protects against heat and moisture
3. Drip-proof end-shields keep out foreign matter
4. Slotted mounting bases; easier belt adjustment
5. Meet or exceed NEMA performance "specs." Built by one of the nation's foremost manufacturers
6. POWR-KRAFT motor guarantee (see below)

POWR-KRAFT motor guarantee

Any POWR-KRAFT Motor, operated according to instructions, that proves defective in materials or workmanship within one year of purchase date will be repaired or replaced free of charge.

POWR-KRAFT heavy-duty mill-type capacitors

(C) $\frac{1}{2}$, $\frac{3}{4}$ and 1-hp motors for extra-hard starting jobs at low prices. Thermoguard® manual overload protector. Far surpass NEMA performance standards. Heavier windings, greater overload capacity. Continuous duty. 115-230V 60 cycle AC. Mounting dimensions $5" \times 5\frac{7}{8}"$.

(C) Use on power tools, compressors in factories, farms, etc. 1750 RPM. Have $\frac{3}{4}$ " diameter keyed single shaft.



\$49.95
 $\frac{1}{2}$ -hp

$\frac{1}{2}$ -HP 83 PE 4580 49.95. $\frac{3}{4}$ -HP

83 PE 54.95. 1-HP 83 PE 4582 58.95

Westinghouse start-stop switch for all motors up to 2-HP 83 PE 4705 4.29

Motor toggle switch for all motors up to $\frac{3}{4}$ -HP. Fits $\frac{1}{2}$ " diameter hole. On-off switch only 83 PE 4702..... 65c
Replacement 3-way; on-off, reverse switch only 83 PE 4703..... 1.19

Power tool stands—built rigid—minimize vibration



Double stand
\$22.95

(D) Double stand will take lathe or any two other power tools except bench saws. Includes 4 tool and 2 motor mounting rails; also motor mounting plate. Dimensions: $24 \times 42"$. 84 PE 2936 22.95



Pegboard panels available for either stand

- Fit most bench-type power tools
- Rigid 12-gauge steel construction
- Height adjusts easily to suit operator use of tool— $24\frac{1}{2}$ to $31\frac{1}{2}"$



Single stand
\$19.98



(E) Single stand for one power tool (not lathe or bench saw). Top: 16-inches square. Bottom: $23\frac{1}{2}$ -inches square. 84 PE 2935. Complete 19.98
Caster set. (not shown) Hard rubber wheels. 84 PE 3379 set of 2 1.25 13

SHOPSMITH — 5 power tools in 1

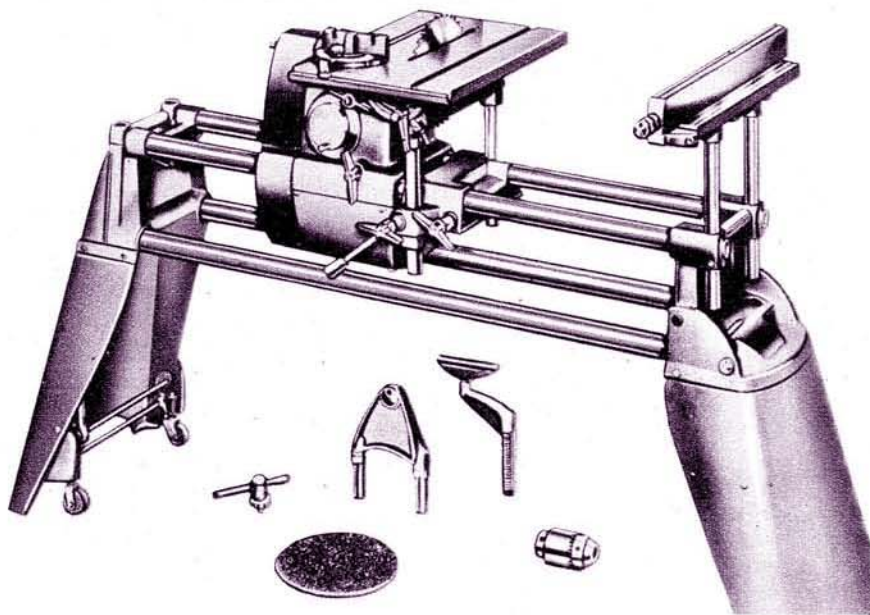

- Work handles all clearly labeled
- Table height control—quick release lever raises and lowers table
- Dual lock rip fence; 1 knob control locks front and rear of fence
- Takes only 19" x 71" floor space

The ultimate in power workshops

Combines 5 major power tools into 1 compact, self-contained unit. Has time and labor saving features found in no other power tool. Utilizes a single spindle, table, motor, and frame. "Speed dial control" lets you dial the exact speed for sawing, jointing, shaping, sanding, etc. No belts or pulleys to change. Guaranteed for 1 full year against defects in materials and workmanship. Complete outfit has built-in 3/4 HP motor with enclosed belt, pulleys, bench, ends, bench tubes, table extension, 9" all-purpose saw blade with 1 1/4" arbor, 12" sanding disc and sheet, drive and cup centers, tool rest, miter gauge, rip fence, 1/2" Jacobs keyed chuck, plus a detailed owner's guide. 84 PE 3469.

Retractable casters 84 PE 3431.. 14.95

The MARK 5 329⁵⁰

Complete with bench and motor

Only \$10 down starts your Shopsmith workshop

- Exclusive "speed dial control"—turn dial to any spindle speed; 700 to 5200 RPM
- Built-in 3/4 HP ball bearing motor
- Power mount for quick, easy mounting of additional tools (see Magna items on next page)
- Depth control dial and lock—all 1 adjustment

Seeing is believing—ask for a demonstration and see for yourself.

MARK 2

The power tool that does the complete job

159⁸⁸
\$5 DOWN
Less motor and stand

- Does over 117 power operations
- "Power mount" lets you add other Magna tools on opposite page
- Choice of six spindle speeds

Get 5 tools in 1—now at one low budget price! Has same fine engineering principles as Mark 5 above but not all its features. Includes lift-off dual locking rip fence, extension table with built-in fence, miter gauge, 8" saw blade, lathe drive and cup centers, tool rest, sanding disc and sheet, Jacobs chuck, plus handy owner's guide. 84 PE 3230.

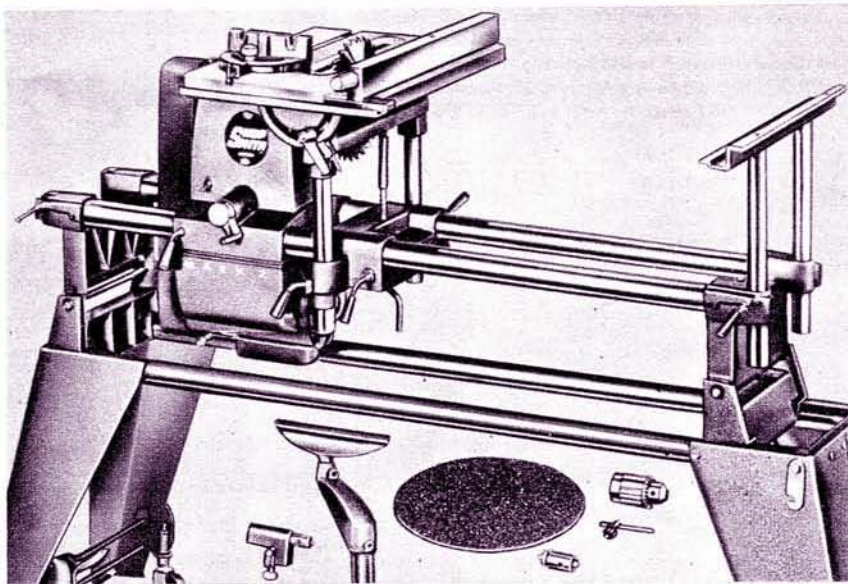

Following accessories fit SHOPSMITH MARK 2 only: 1/2 HP motor 84 PE 3245 29.95. 3/4 HP motor 84 PE 3243 34.95. Bench and bench tubes only 84 PE 3231 19.95. Saw guard 84 PE 3236 7.95.

Retractable casters 2 pair 84 PE 3232 14.95.
Table insert (no slot) 84 PE 3233 1.45.
Table insert (for dado) 84 PE 3234 1.45.
Table insert (molding) 84 PE 3235 1.45.
Table insert (saw slot) 84 PE 3237 1.45.

Most versatile—it's a bench saw, disc-sander, a lathe, vertical drill press, horizontal drill!

5 TOOLS IN 1!

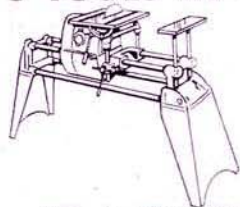

IT'S A 9" SAW

Use it for almost every project: Use to crosscut, rip, bevel, miter, dado. Extra large capacity. Tilting table!

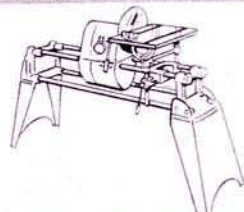

A 12" DISC-SANDER

For sanding to exact length, width; for squaring workpiece; for smooth finish; for jointing wood.

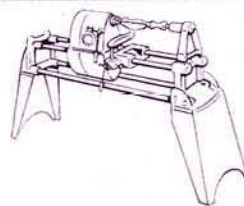

A 34" LATHE

Completes your workshop. The one tool that lets you do "creative" jobs with a minimum of experience!

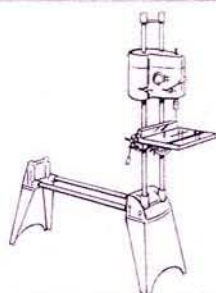

A 16½" DRILL PRESS

You'll use it to drill, bore, rout, mortise, countersink; for hundreds of other operations. Jacobs geared chuck.

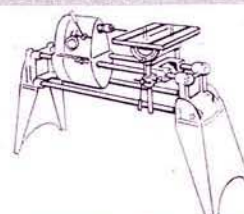

A HORIZONTAL DRILL

Does hundreds of drilling jobs that are too awkward or actually impossible to do on a vertical drill press!

MARK 5

CONVERT SHOPSMITH INTO JIG SAW, JOINTER, BELT SANDER, PAINT SPRAYER, BAND SAW WITH THESE MAGNA ATTACHMENT TOOLS

Build while you pay. Pay \$2 to \$5 DOWN, as little as \$5 a month.

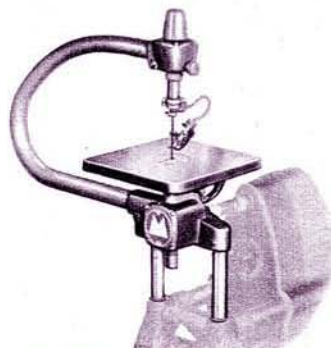

MAGNA 18" JIG SAW

Heavy-duty ball-bearing model. "Doubles" as a sabre saw. 11 x 11" table tilts to 45°. Universal chucks rotate 90°. Adjustable blade guides assure accurate cutting. Has built-in blower. Quick blade tension adjustment for any blade gives better operating control. With 5" plain end blade.

84 PE 3429.....58.50

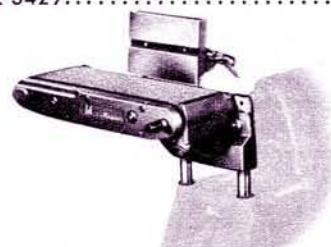

MAGNA 6" BELT SANDER

Operates in any position from horizontal to vertical. Sealed ball-bearing drive-shaft. Belt travels over 6 x 16¼" back-up plate on 3" drums. 6 x 9" table has miter gauge slot, tilts either direction. 6 x 48" belt included.

84 PE 3474.....59.50

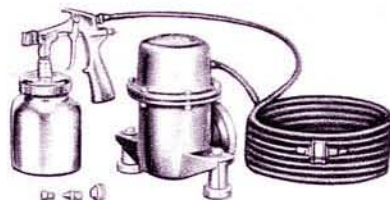

MAGNA PAINT SPRAYER

Diaphragm compressor displaces 4 cubic ft. of oil-free air. At 1750 rpm it delivers 2.4 cu. ft. of air at 30-lbs. External, internal-mix spray-heads. Use heavy enamels, lacquers. With hose, gun, 1-qt. cup, tire inflator.

84 PE 3472.....49.95

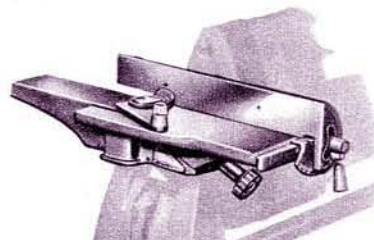

MAGNA 4" JOINTER

Ball-bearing model—heavy cast-iron construction throughout. Width of cut, 4"; maximum depth of cut single pass ¾". Rigid cast-iron fence adjusts to 45° either way with automatic stops. With safety guard that mounts at front or rear. Long 28" table. Cutter head 2¼" diameter. Knives individually adjustable.

84 PE 3449.....58.50

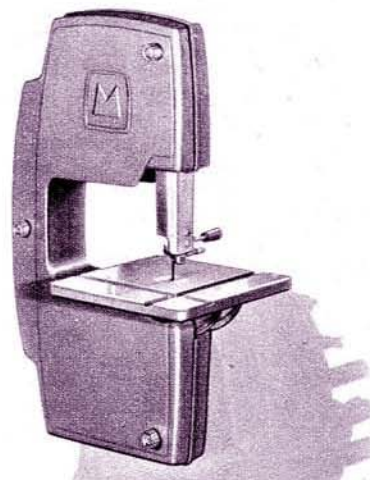

MAGNA 11" BAND SAW

Heavy-duty model. Cuts stock up to 6" thick. Adjustable blade guides. Automatic blade-tracking feature. Large 11¾" x 12-in. table tilts up to 45°. Has sealed-for-life ball and needle bearings. Comes with ¼ x 72-in. blade.

84 PE 3357.....79.95

Magna 5" Plain End Jig Saw Blades

Use For	Catalog Number	Teeth per in.	6 for
Composition.....	84 PE 3110	20	55c
Wood, rubber....	84 PE 3111	14	55c
Plastics, bone....	84 PE 3112	7	55c
Wood, plastics....	84 PE 3113	18	55c
Alum., copper....	84 PE 3114	20	55c
Metals, wood....	84 PE 3115	15	55c
Alum., copper....	84 PE 3116	20	55c

Jig saw file set (not shown) includes triangular, round, square, half-round, pillar and crochet shapes. 84 PE 3118.....5.95

Do hundreds of jobs faster with

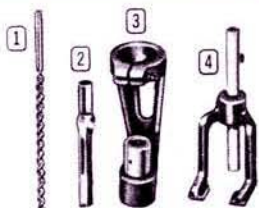
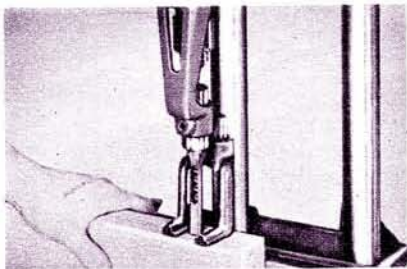

MORTISING ACCESSORIES

(1) to (4) Eliminate tedious hand work and make your power tools more versatile. Fit Shopsmith or POWR-KRAFT drill press (page 7).

(1) **Mortising bits.** Use with chisels below. Choice of 1/4, 3/16, 3/8 or 1/2" sizes. Tempered steel. 84 PE 3135.....each 2.95

(2) **Mortising chisels.** Use with bits above to cut square holes for mortise and tenon joints. 1/4, 3/16, 3/8 or 1/2". 84 PE 3134.....each 4.45

(3) **Mortising attachment** guides chisel and bit for cutting accurate square holes. Use on horizontal or vertical drill press. Cast iron with steel sleeve. 84 PE 3450.....4.45

(4) **Mortising hold-down** adjustable to varying thicknesses. Prevents lifting of workpiece when chisel and bit are withdrawn. Holds work to table securely. Fits Shopsmith Mark 2 and Mark 5 only. 84 PE 3451.....3.45

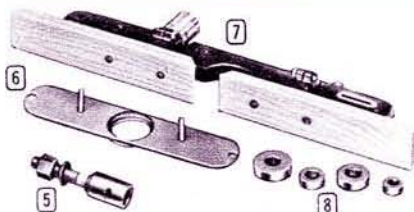
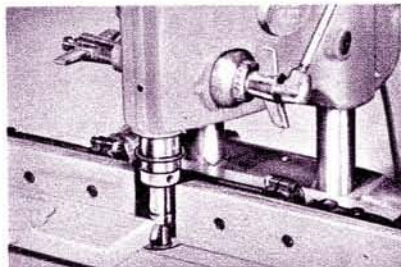

SHAPING ACCESSORIES

(5) to (8). Table Insert (6) fits Shopsmith Mark 5 only. Others fit Shopsmith or POWR-KRAFT drill press #2525 on page 7.

(5) **Shaper adaptor assembly.** Use for mounting of three-lip shaper cutters with 1/2-inch bore. 84 PE 3460.....1.75

(6) **Cast aluminum table insert.** For shaping curved work against collars. Removable fulcrum pins. 84 PE 3443.....2.45

(7) **Shaper fence** controls depth of cut for shaping straight-edged boards. Locks to table. In-feed and outfeed fences adjust for depth of cut. Fits Mark 2 and Mark 5 only. 84 PE 3425.....13.95

(8) **Shaper collars** for controlled depth of cut on curved surfaces. Set of four: 2 3/32 to 1 1/2" outside diameter. Fit 1/2-inch shaper adaptor. 84 PE 3139.....set 2.25

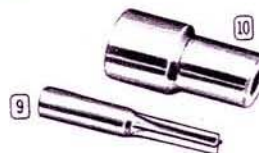
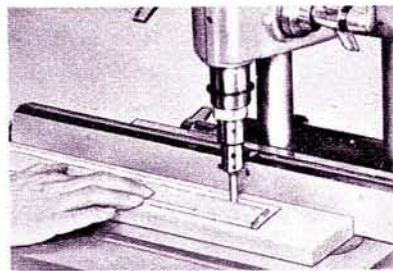

ROUTING ACCESSORIES

(9) (10) Add versatility to Shopsmith or POWR-KRAFT drill press. Cut round end mortise, edge grooves in short or long stock, grooves in curved segments (with guidance of template.) For routing grooves in circular work, use miter gauge as pivot. Also use pivot arrangement to form edge grooves in circular pieces. For pattern routing, pattern on plywood or hardboard is attached to underside of work with short flathead screws. Screws may protrude to provide points onto which work may be pressed and held while routing.

(9) **Router bits** 1/2" diam. shanks. 1/4, 3/16, 3/8 or 1/2" cutting size. Use with router chuck. 84 PE 3136.....each 2.45

(10) **Router chuck** fit 1/2" diam. shanks. For routing and other operations requiring added side thrust. 84 PE 3457.....2.45

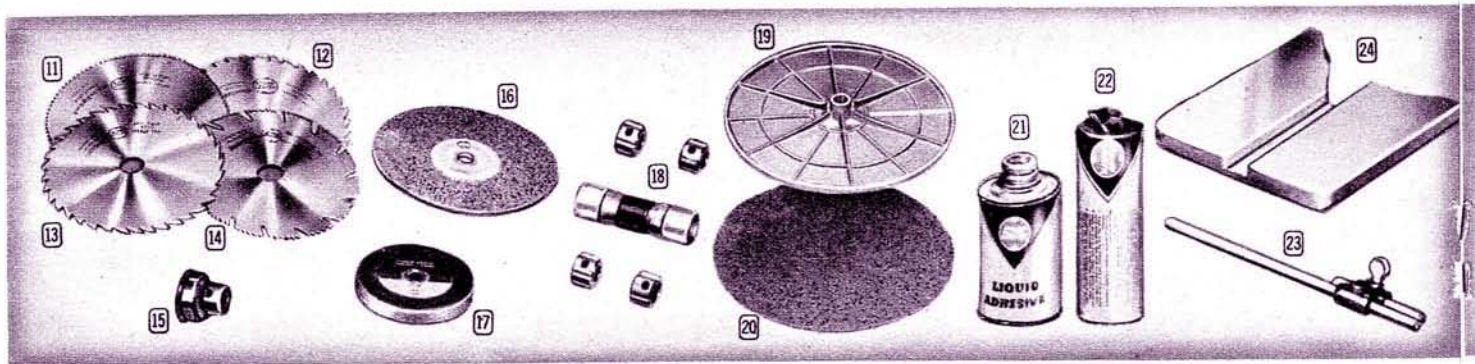

(11) to (14) 9-inch diameter saw blades. Fit Shopsmith Mark 5 only. 1 1/4" arbor hole.

(11) **Crosscut saw blade** for fast, easy cutting across grain. 84 PE 3436.....3.95

(12) **All-purpose saw blade.** Eliminate blade changing. 84 PE 3434.....3.95

(13) **Rip saw blade.** For fast, easy ripping with grain. 84 PE 3437.....3.95

(14) **Combination blade** rip; crosscut; miter. Tapered, hollow-ground teeth for fine mitering work. 84 PE 3435.....6.95

(15) **1 1/4" saw arbor** for blades listed above. An arbor on every blade makes it possible to change blades in seconds. 84 PE 3433.....2.75

(16) **8" flexible cut-off wheel** impregnated with abrasive—cuts all metals. 5/8" arbor hole. Also fits POWR-KRAFT Saws. Wear goggles and do not use for operations exerting side pressure on wheel. 84 PE 3123.....3.95

(17) **Rubber-bonded abrasive wheel** for sharpening tools. 5" diam.; 3/4" thick; 5/8" arbor hole. 84 PE 3448.....5.95

(18) **Power mount coupling kit** adapts Magna Tools (page 15) to fit Shopsmith Mark 2 and Mark 5. 84 PE 3462.....4.95

(19) **Disc for sanding.** 12" diameter, 5/8" arbor hole. 84 PE 2977.....5.95

(20) **POWR-KRAFT sanding sheets.** 12" diam. For wood. Choice of Fine, Medium, Coarse or assorted grits. Fit #2977. 84 PE 2010 6 for 1.79

(21) **Liquid adhesive.** 84 PE 3149.....1.45

(22) **Distic adhesive.** 84 PE 2980......95c

(23) **Miter gauge stop rods.** Use with miter gauge as a jig for crosscutting workpieces to same length. Adjustable from 0 to 18 inches. Fits Shopsmith Mark 5 and 2. Also POWR-KRAFT 9" and 10" bench saws (see pages 4 and 5) 84 PE 2988.....1.65

(24) **14" front table extension** attaches to front of Shopsmith. 84 PE 3439.....4.95

Shopsmith accessories

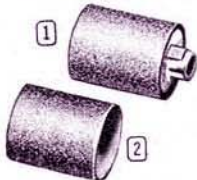
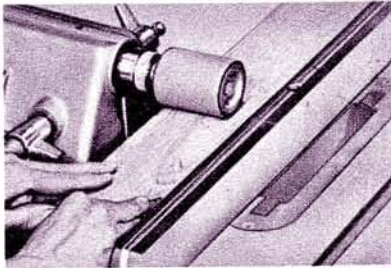

DRUM SANDING ACCESSORIES

(1) to (2). For surface sanding of narrow boards, contour sanding, sanding rabbets to width. Fit Shopsmith or Powr-Kraft lathe on page 8 or POWR-KRAFT drill press on page 7.

(1) **Sanding Drum.** Excellent for fast contour sanding—use in vertical or horizontal position—and on inboard or outboard spindles of Shopsmith. When "edge-sanding" that can be rested on flat surface, it is best to use machine in vertical position. Use also with shaper fence (7) on opposite page. Expanding rubber type drum holds sleeves firmly. 3" wide, 2 1/4" diam. Includes one medium grit sanding sleeve. 84 PE 2975. .3.95
 (2) **Sanding Sleeves.** 2 1/4" diam. Medium, coarse or assorted grits. Fit sanding drum above. 84 PE 3133.Pkg. of 6 1.45

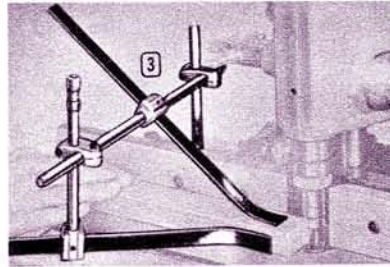

UNIVERSAL HOLD-DOWN

(3) Mounts on miter gauge, rip fence or shaper fence. Holds work securely against fence and table, thereby keeping hands out of danger zone. Prevents chatter by holding work firmly when shaping, routing, sawing, molding, etc. Holds odd-shaped pieces firmly for cutting. Long mounting bars allow maximum adjustment in thickness and width of work. Special clamp included permits mounting on any side of Shopsmith table in horizontal or vertical position. You'll find this set so versatile it's like owning another pair of hands. Fits Shopsmith or POWR-KRAFT drill press. 84 PE 3426.11.95

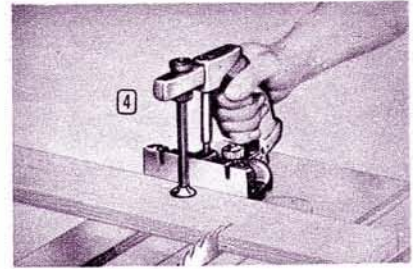

MITER GAUGE PISTOL GRIP

(4) This revolutionary new accessory is another exclusive SHOPSMITH safety feature. Your hands need never come close to the saw blade . . . yet you cut with complete accuracy. Simply grasp pistol grip firmly and it clamps your workpiece securely against table and miter gauge. Pressure grip counteracts tendency of saw-blade to "pull" work, thereby assuring accurate miter cut. Equally useful for bevel-sanding for positive control of work. Fits Shopsmith Mark 5 and Mark 2 on page 14; also POWR-KRAFT 10" bench saw #3333 on p. 4 and POWR-KRAFT 9" bench saw #3486 on p. 5. 84 PE 3444.9.95

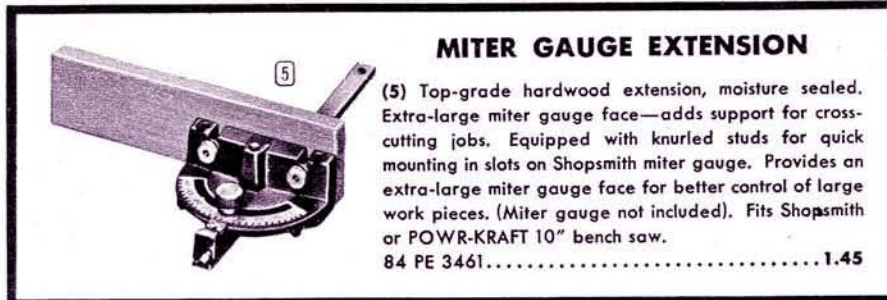

MITER GAUGE EXTENSION

(5) Top-grade hardwood extension, moisture sealed. Extra-large miter gauge face—adds support for cross-cutting jobs. Equipped with knurled studs for quick mounting in slots on Shopsmith miter gauge. Provides an extra-large miter gauge face for better control of large work pieces. (Miter gauge not included). Fits Shopsmith or POWR-KRAFT 10" bench saw. 84 PE 3461.1.45

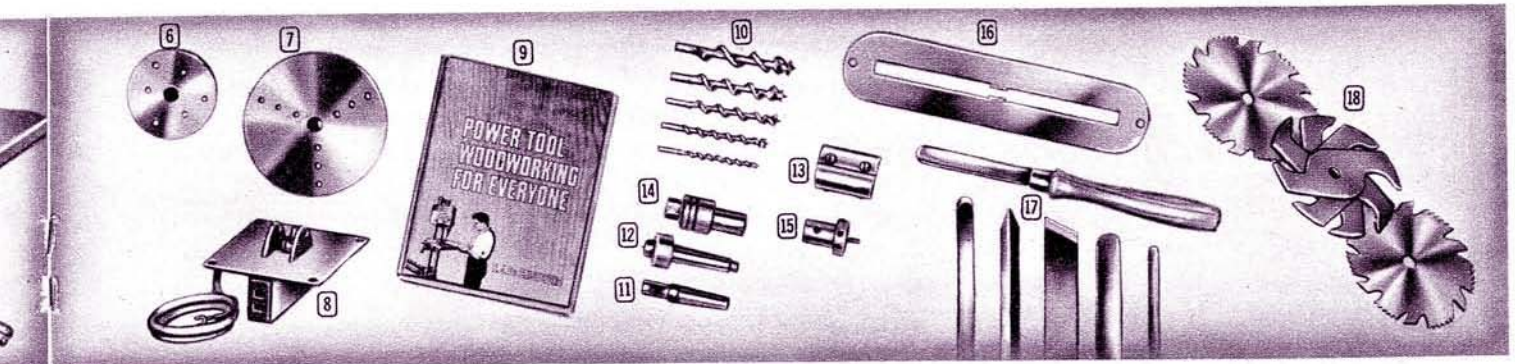

(6) (7) **Face Plates.** Use for turning workpieces which cannot be supported between centers (7) 3 3/4" diam. 84 PE 2982 2.45. (8) 6" diam. 84 PE 2983.3.95
 (8) **Safety Switch** 84 PE 3381.4.45
 (9) "Power Tool Woodworking for Everyone". By R. J. DeChristoforo. Describes, teaches use of power tools. 352 p. 84 PE 3392. . . .4.95
 (10) **5-pc. Auger Bit Set.** Fits 5/8"-1/2" chuck. 1/4, 3/8, 1/2, 5/8 and 3/4-in. sizes. For soft or hard wood. 84 PE 3107set 8.45
 (11) **Tailstock Chuck Arbor.** Holds Jacobs chuck in lathe tailstock. 84 PE 3132.1.45

(12) **Tailstock Live Cup Center.** Ball-bearing action. 84 PE 31093.65
 (13) **Jointer-Cutter.** Use with shaper fence (Item 5) on opposite page.) 3 tool steel blades removable for sharpening and adjustment. 84 PE 3453.9.95
 (14) **Arbors.** Includes special keyed washer to prevent loosening. 84 PE 2998. For 1/2" bore 2.75. 84 PE 2999. For 3/8" bore.2.75
 (15) **Screw Center.** Holds small size workpieces. 84 PE 2990.1.95
 (16) **Table Inserts.** Fit Shopsmith Mark 5 only. Sturdy cast-aluminum alloy.

1/2" saw slot. 84 PE 3441.1.75
 (17) **Lathe Chisel Set.** Includes 1" skew, 1/4" gauge, 3/4" gauge, 1/2" round nose, 1/2" parting tool, to handle most lathe operations. 84 PE 3131set 9.95
 (18) **6" Dado Head.** Includes two outside blades, and four chippers. Maximum width cut 1 1/8". Cut adjusts by changing number and thickness of chippers between blades. Use for dadoing, grooving, rabbeting, tenoning, etc. 84 PE 3126.15.95

Due to transportation costs, prices may vary in certain areas.

POWR-KRAFT ball-bearing grinders

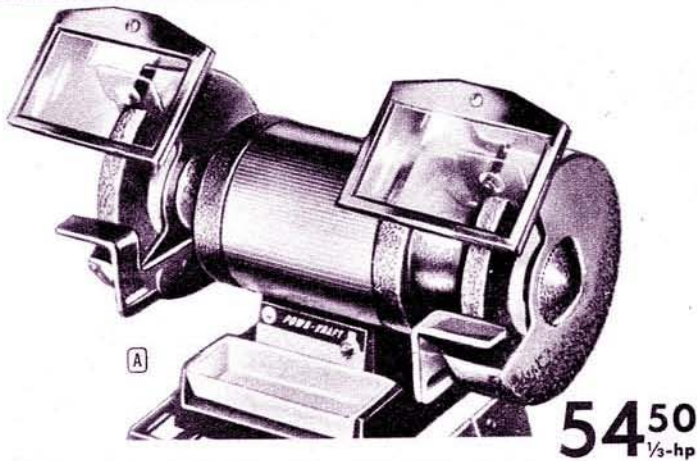

COMPARE WITH GRINDERS SELLING AT \$75!

- Designed for heavy-duty use in factories, shops
- UL approved to rigid industrial standards
- Runs smoothly on grease-sealed ball bearings

(A) POWR-KRAFT 1/3-HP heavy-duty grinder. Designed for production use! Use it to grind, sharpen, finish, polish, deburr, etc. Totally enclosed 1/3-hp motor. Non-rusting water pot. Adjustable tool rests and safety glass shields. Com-

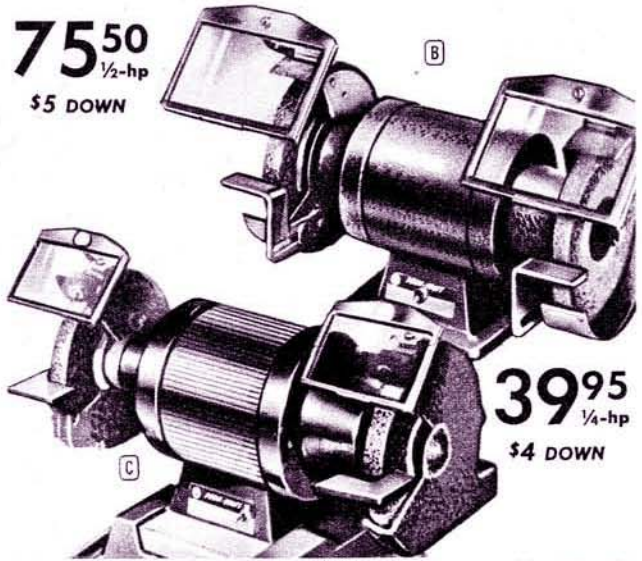

75⁵⁰
1/2-hp
\$5 DOWN

39⁹⁵
1/4-hp
\$4 DOWN

plete with two 6 x 3/4" vitrified aluminum oxide wheels. Guaranteed one year. 84 PE 5141.....**54.50**
(B) POWR-KRAFT 1/2-HP heavy-duty grinder. Has all features listed at left plus: 1/2-HP motor, wheel-guard exhaust ports, 5/8" arbor, 7 x 1" vitrified aluminum oxide wheels. Cast iron base. 84 PE 5142.....**75.50**
(C) POWR-KRAFT 1/4-HP utility grinder. Ideal for home workshop. Completely-enclosed 1/4-HP motor. Two 6 x 1/2" vitrified aluminum-oxide wheels. 84 PE 5140.....**39.95**

POWR-KRAFT belt-driven, ball-bearing models



16⁵⁰
Grinder only

- Wheels project beyond front of housing—grind across wheels, drive from below, behind, any angle
- Heavy cast-iron frames—minimizes all vibration

All models operate on shielded precision ball bearings. Also have steel wheel guards, precision ground shafts, adjustable tool rests.

POWR-KRAFT 6" bench grinder for heavy duty garage and production work.

Has two 6" x 1" grinding wheels, 2" diameter pulley. 84 PE 5154.....**16.50**
POWR-KRAFT 8" bench grinder for heaviest work. Two 8 x 1 1/4" wheels. 2 3/8" diam. pulley. 84 PE 5157....**27.50**
POWR-KRAFT 5" bench grinder. Suitable for home workshop. Two 5 x 1" wheels, 2" diam. pulley. 84 PE 5151 **10.95**

Due to transportation costs, prices may vary slightly in certain areas.

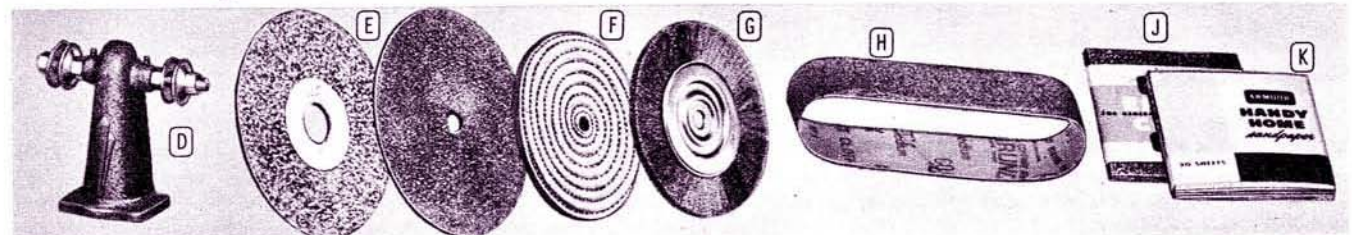

(D) Polishing head takes accessories 1/2" to 3/4" thick. Height to spindle center 5", 1/2" 24-thread, 7 3/4" long. 84 PE 2768.....**3.29**

(E) "MX" Cut off wheels. Extremely safe for high speed cutting of metallic and non-metallic materials. Shatter-proof cotton fabric and abrasive construction allows grinding on side or edge with maximum safety. For metallic cutting. 84 PE 5243. 6" x 3/32".....**2.15**
 For non-metallic cutting. 84 PE 5244. 6" x 3/32".....**2.15**

(F) Cloth buffing wheels. 84 PE 2784 4" diam. 55c. 6" 75c

(G) Wire scratch brushes with 1/2" arbor hole. Fine wire 84 PE 2778 4" **1.15**. 6" **1.65**. Coarse wire 84 PE 2779 4" **79c**. 6" **1.29**

(H) Aluminum oxide sanding belts for belt-type power sanders. Fine, medium or coarse. 3 x 24" 84 PE 8531 **2/98c**. 4 x 36" 84 PE 2729 **2/1.50**. 6 x 48" 84 PE 3388 each **1.75**

(J) Emery cloth. Handy packs of 6 assorted grit sheets. 4 1/2 x 5 1/2", 84 PE 4119.....**25c** each. 9 x 11", 84 PE 4121.....**15c** each sheet.

(K) Sandpaper sheets. 15 assorted grits in handy package of 15. 4 1/2 x 5 1/2", 84 PE 4113.....**19c** Pkg. 9 x 10", 84 PE 4115.....**3** for 10c

Save on *POWR-KRAFT* welders



TWO-STAGE WELDER

- Maintains constant pressure, start to finish
- Welds metal to 2"; cuts to 6" thickness
- Automatic torch—both efficient and economical

POWR-KRAFT two-stage regulator outfit with automatic torch. Made for Wards by Harris Calorific. Finest, most complete outfit ever offered! Provides greater safety, accuracy, dependability. Guaranteed one full year. Includes welding torch, 3 welding tips, cutting attachment, 2 acetylene cutting tips, 2-stage oxygen and acetylene regulators, goggles, torch lighter, instruction books, 25' twin hose. 84 PE 5878.

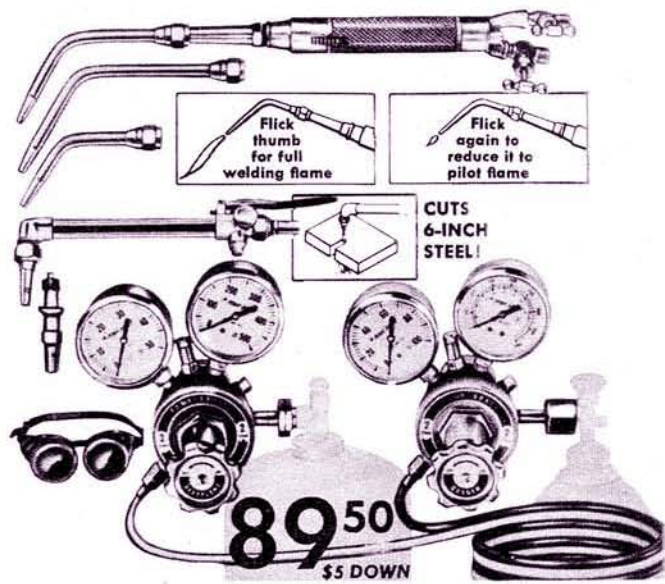

SINGLE-STAGE WELDER

- Best performance and quality at this price
- Equal pressure-type torch; welds metals up to 2"
- Made of finest materials for long service

POWR-KRAFT single-stage gas welding outfit. Manufactured by Harris Calorific. Precision-made for trouble-free operation. Rigidly tested. Approved by Wards Laboratories, also UL. Backed by Wards 1-year guarantee! Includes welding torch, 3 welding tips, oxygen regulator, acetylene regulator, goggles, torch lighter, instructions, 25' welding hose. 84 PE 5875.

Welding and cutting outfit 84 PE 5876.....116.50

Ask for your **FREE** copy of: "Metalworking made easy by Arc Welding."

Complete welder—equal to models at \$200

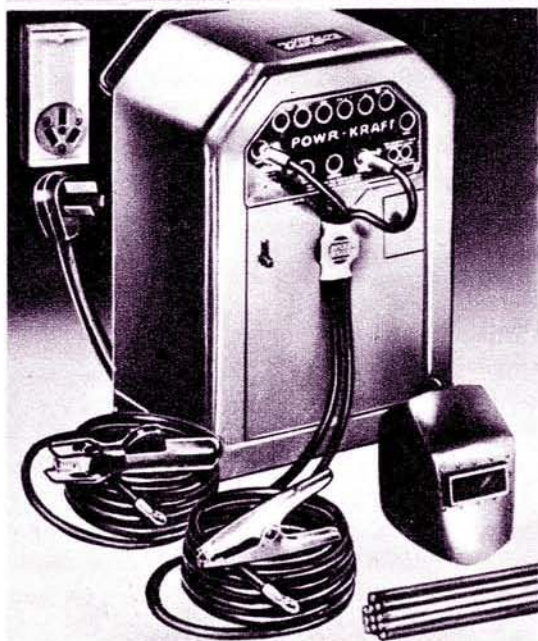

179⁵⁰
\$5 DOWN

- Welds steel from 1/32" thick up to heavy plate
- Guaranteed one full year

POWR-KRAFT 180-Amp., 230 Volt model. UL approved—meets or exceeds REA, NEMA requirements. Provides fastest means of welding—producing an intense heat of 6500° to 7000° F. Makes strong and ductile welds. Complete outfit—ready to use. 84 PE 5938.



A



A Fiber-glass welding helmet. Provides full protection. Lightweight. Lens flips up for work inspection. Utmost in comfort. 84 PE 5900.....10.95
B Asbestos gloves. 14" Underwriters'

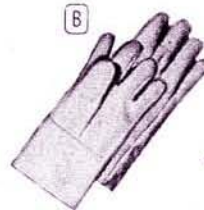

B

C

grade basket weave. Flannel lined. Provide free finger action. Large size only, 84 PE 5959, pair.....3.98
C Cowhide welder's gloves. Wool lined. Large size 84 PE 5960, pair . 2.59

Fast efficient *POWR-KRAFT* sanders

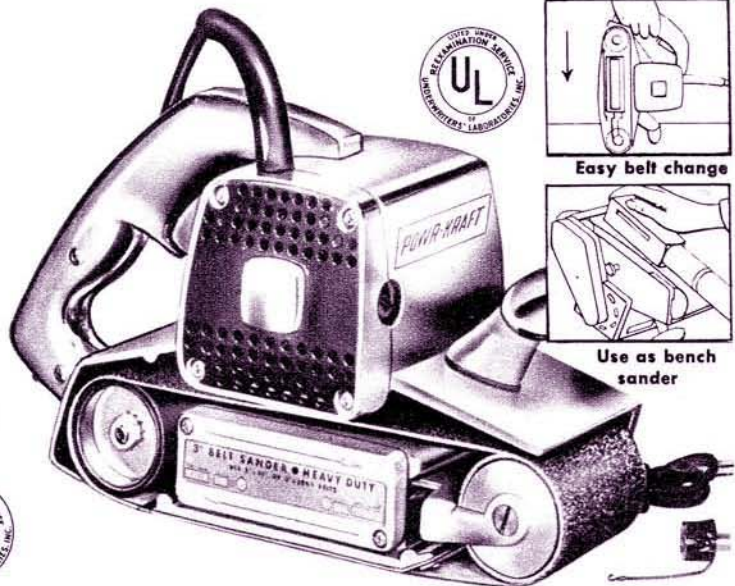

Heavy-duty orbital sander

- Gives fast, smooth finish on wood, plastics or metal
- Perfectly balanced; designed for flush sanding

39⁹⁵
\$4 DOWN

Rugged, man-size tool—sturdy, powerful (can't be stalled) for fast sanding, yet soft and gentle enough to give a satin-smooth finish. Delivers 4500 strokes per minute. Includes sander, 6 assorted sheets. 84 PE 8555.....**39.95**
Aluminum oxide sanding sheets assorted grits. 3²/₃" x 9". Fit 8534, 8520, and 8555. 84 PE 8509.....**10 for 59c**

Heavy-duty belt sander

- Compare with similar sanders selling for \$18 more!
- Sealed ball bearing model for continuous production use!

59⁹⁵
\$5 DOWN

For toughest sanding jobs; ideal for boat maintenance! Free belt speed 1650 feet per minute. Change belts in a jiffy; press to loosen; release, belt locks in place. 8' cord.

84 PE 8560.....**59.95**

Extra sanding belts. 84 PE 8531.....**2 for 98c**

Due to transportation costs, prices may vary in certain areas.



19⁹⁵

POWR-KRAFT utility sander

Larger sanding area and greater power than vibrator sanders. Universal motor provides power for all jobs. Duplicates circular motion of hand finishing—leaves work free from "reversing points." Ideal for home workshop, also as an auto feather-edger. 3500 strokes a minute. Lightweight, aluminum body. 6 ft. cord, rubber sanding pad. Guaranteed one year. 84 PE 8534 **19.95**



12⁹⁵

POWR-KRAFT vibrator sander

Why sand by hand?—this sander is ideal for light sanding, polishing, fine finishing, etc. For only 12.95 you save yourself the tedious work of sanding for hours. Do smoother, more uniform work in 1/4 the time! Large 24 sq.-inch sanding area. Lightweight—not affected by dust, dirt. Low-priced! Includes sander, sanding sheets, polishing cloth, cord. 84 PE 8520.....**12.95**

WHICH SANDER IS BEST?

Vibrator type sander designed for light sanding or use with soft pads for polishing.

Orbital sander. An "all-purpose sander". Used for finishing, fast removal work, and polishing.

Belt sanders. Best for production use and continuous work. Ideal for fast removal on large flat surfaces, floors, boat decks, etc.

POWR-KRAFT 6" sander-polisher



26⁵⁰

\$3 DOWN

POWR-KRAFT rotary model. With 6 sanding sheets, flexible rubber pad polish bonnet. 84 PE 8526. Extra sanding discs. 84 PE 9361.....**5 for 55c**

Does 90% of all woodworking jobs!

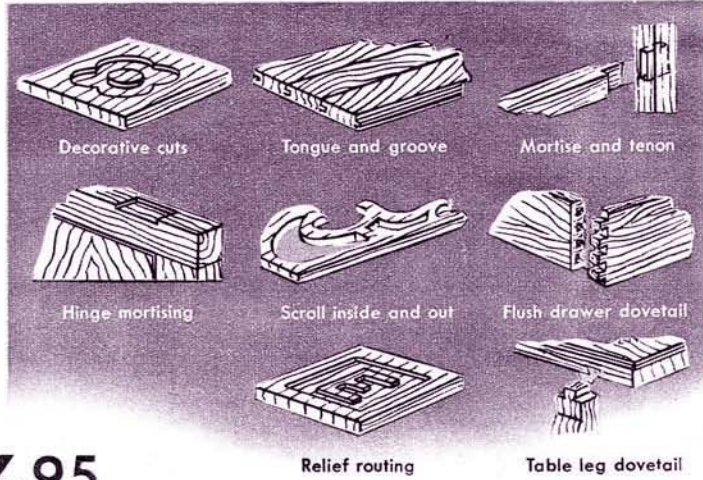
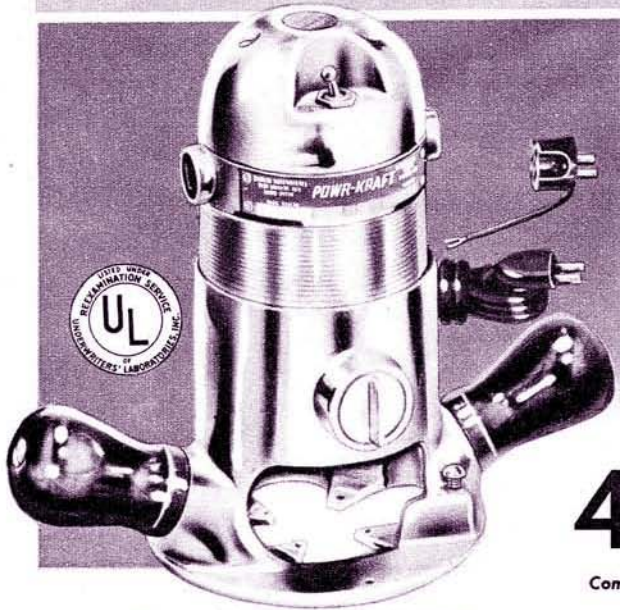

46⁹⁵
\$5
DOWN
Complete with motor

Makes cuts shown above plus beading, inlaying, fluting, rounding over, etc.

POWR-KRAFT 3/4 HP ROUTER FOR INTRICATE JOBS

The most versatile of wood working tools. With it any amateur can handle work that formerly required a master cabinet maker. Rabbit cuts, mortise and tenons, spline joints, all of the most intricate joints are made quickly and with a minimum of practice. This 3/4 HP model has a ball-bearing motor operating at 22,000 rpm. . . an extra high speed that gives smoother cuts with or against the grain, and gives a free-flowing action that makes creative

designing in wood a pleasure for the youngest, most inexperienced wood worker. He can make name plates, plaques, flower boxes, book cases, and many other useful and ornamental household projects. A threaded motor housing provides a micrometer depth adjustment that insures accuracy when it comes to precise inlaying, or beading and fluting. And, it can be converted into a planer for even greater versatility (see below).

Try these tools yourself—come in and ask Wards salesman to demonstrate them.

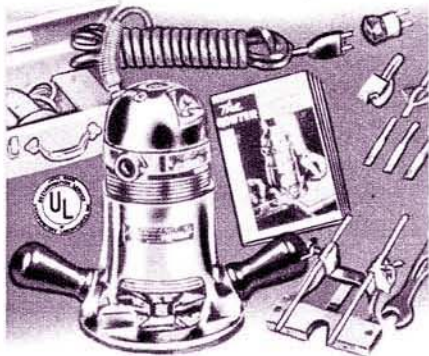

POWR-KRAFT ROUTER KIT

Complete router with 3/4 HP motor, router sub-base, straight and circular guide for maximum control and accuracy. 5 High-speed bits: 1/4" straight, 3/8" straight, 1/8" veining, 3/8" round-over and 1/2" mortising. Chuck, wrench and easy-to-follow instructions. Sturdy steel carry case protects router, keeps everything handy. Fully guaranteed for one full year by Wards.
84 PE 856469.95

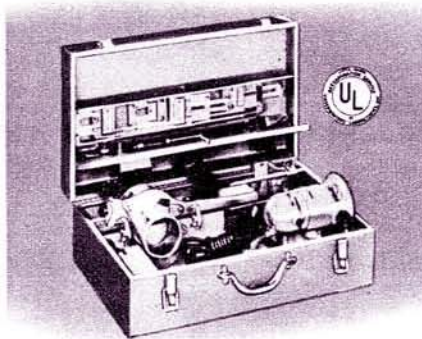

POWR-KRAFT BUILDER'S KIT

Does 101 jobs! Use for hanging doors, other routing, planing jobs. Templet adjusts to mortise 2 or 3 hinges on doors 1 3/8" to 2" thick; guides cutter for uniform size, depth. Includes motor, router attachment, planer attachment, door and jamb butt templet, templet guide, arbor, two mortising bits, straight and circular guide, router sub-base, plus handy carry case.
84 PE 8570139.95

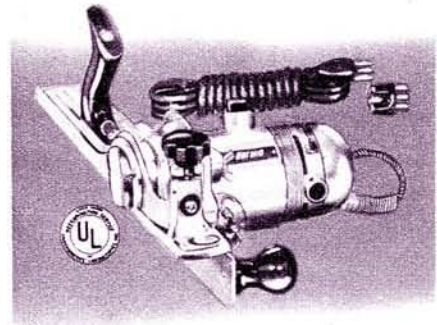

PLANER ATTACHMENT

Large capacity 16" Planer (without motor). Planes doors up to 2 1/4" thick with one pass. Ideal for dressing lumber, storm windows, screens, etc. Leaves smooth, waveless surface. Tilts for angle planing. Includes Plane Arbor, 2 1/8" Blade and Wrench. Fits (A) router above. Add this to your router Kit and have both—a power router and power plane.
84 PE 856639.95



84 PE 8589
\$6.25
3/8-inch
cove



84 PE 8590
\$4.50
9/16-inch
dovetail



84 PE 8591
\$5.95
15/16-inch
rabbeting



84 PE 8592
\$5.50
1/2-inch
rom. ogee



84 PE 8598
\$2.45
1/2-inch
mortise

POWR-KRAFT heavy-duty 2-speed 3/8" drill

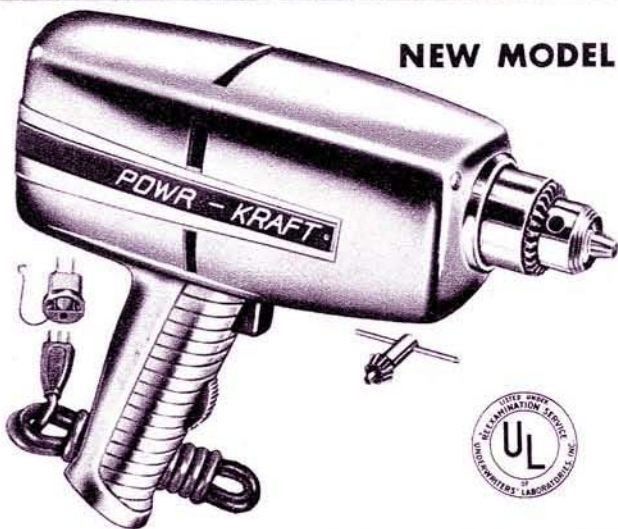

NEW MODEL CHANGES SPEED WITH FLICK OF SWITCH!

- Slow speed for drilling in concrete
- Fast speed for drilling in metal or wood
- No gears to shift, no chucks to change
- 1/4-hp motor. Ball thrust and spindle bearing

Another POWR-KRAFT "first!" Provides range of speeds: HIGH speed for drilling in wood or metal or operating high speed attachments. LOW speed provides twice the power for drilling in concrete, masonry, polishing. 1000 RPM no-load; 600 RPM full-load on "low." 2000 RPM no-load; 1200 RPM full load on "high." Fully guaranteed for 1 year. Has 3/8" Jacobs geared chuck and 10-foot 3-wire safety cord. 84 PE 9306

32⁹⁵

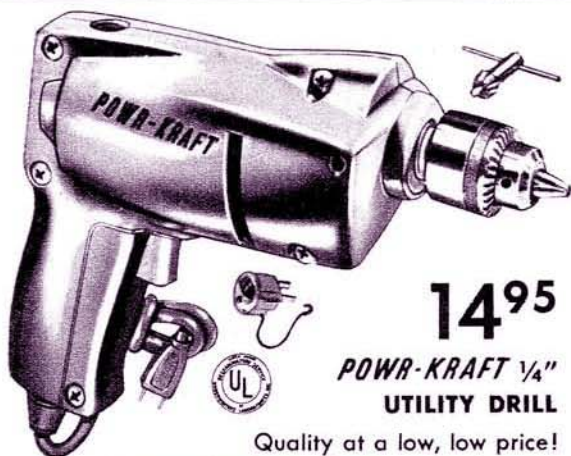

14⁹⁵

POWR-KRAFT 1/4" UTILITY DRILL

Quality at a low, low price! Ideal for home-owner or hobbyist. Sturdy 1/8-HP 2.0 amp motor, 2000 RPM. Locking trigger switch with automatic release. Jacobs geared chuck and key. 84 PE9300

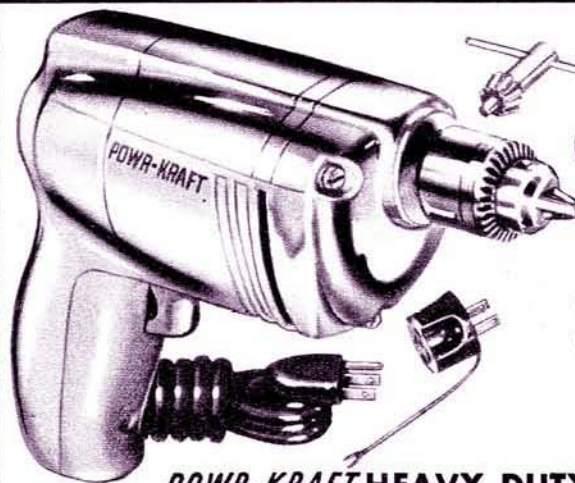

POWR-KRAFT HEAVY-DUTY 1/4" DRILL

- Heavy-duty model for shop, garage, home or farm
- Powerful 1/4-hp 2.4 amp. motor—UL approved
- Fully guaranteed for one year

Our "best buy rated" drill. Ball thrust and spindle bearings assure long trouble-free service! Double reduction gear for maximum power; 1800 RPM. Precision-cut steel gears. Aluminum alloy housing. Jacobs gear chuck and key, 6-ft. 3-wire cord. Guaranteed one year. 84 PE 9301

Full ball thrust and spindle bearing construction throughout to assure years of service

22⁹⁵

Due to transportation costs, prices may vary in certain areas.

Professional quality 1/4" drills



28⁹⁵ POWR-KRAFT 3/8" LOW speed drill

500 RPM speed provides more torque for heavy jobs. No-load speed 1000 RPM. 1/4-HP 2.4 amp motor, ball thrust and spindle bearings, precision-cut gears, 3/8" Jacobs gear chuck.

84 PE 9305



CHOOSE SPADE OR PALM GRIP

- Powerful 1/3-HP 3.0 amp. motor
- Ball and needle bearing construction throughout
- Low-priced for this professional quality

POWR-KRAFT professional—finest 1/4" drill you can buy! Approved to rigid industrial specifications. Double reduction gear train: 1800 RPM. Power for all drilling operations. Runs any accessory. Jacobs gear chuck. 10-ft. 3-wire cord. Choice: Palm grip 84 PE 9303 Spade grip84 PE 9304

34⁹⁵

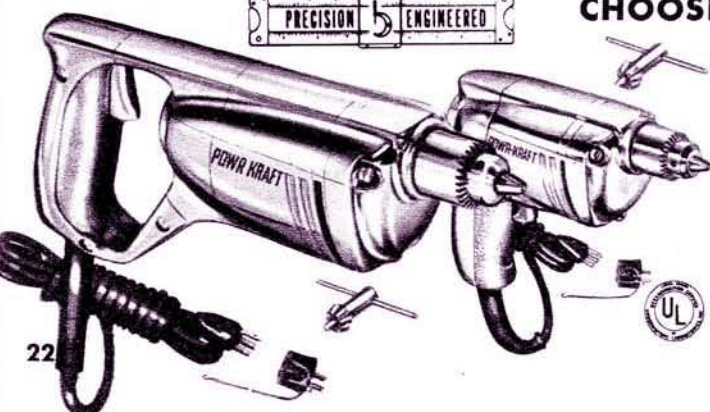

POWR-KRAFT big 39-piece 1/4" drill kit

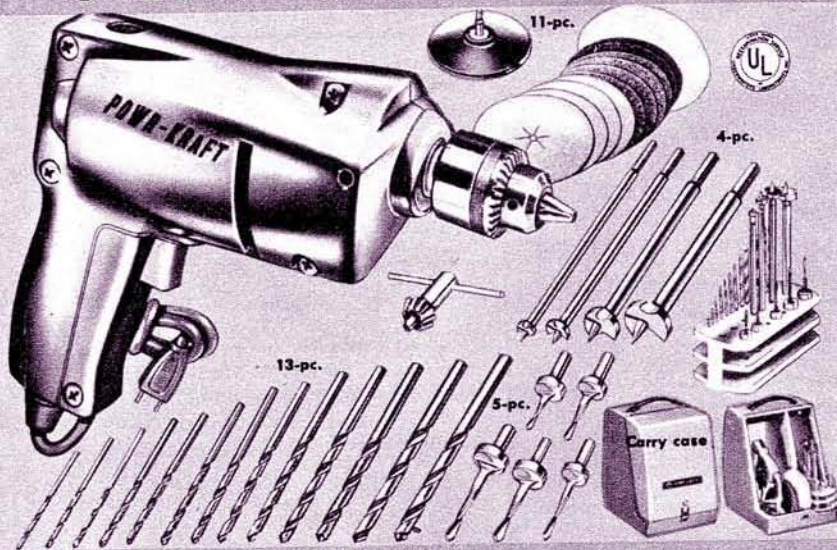

- Never before did so little buy so much
- Includes 1/4" drill and 38 accessories
- Most versatile for home, farm or garage

You'll use this kit for drilling in wood and metal, sanding, polishing, etc. Includes 13 high-speed bits (1/16" to 1/4"), 4 wood boring bits (1/2" to 1"); 5-pc. screw pilot set, polishing bonnet, 10 sanding discs, backing pad, arbor assembly. Complete with handy carrying case and POWR-KRAFT utility drill. The utility drill has double reduction gear and Jacobs chuck. Fully guaranteed for one year. 84 PE 9292

\$3 DOWN
COMPLETE KIT

29⁹⁵

POWR-KRAFT — most complete kit ever sold

- Engineered to do many jobs—give years of trouble-free service
- Drill has 1/4-HP motor; powerful enough to drill in all types of metal or wood and to operate any drill accessory

Designed to perform the greatest variety of jobs. Includes 13 high-speed bits (1/16" to 1/4"); 4 high-speed boring bits (1/2" to 1"); screw pilot drills; power screwdriver (a real work-saver); polishing kit with 10 sanding discs, lambswool bonnet, rubber pad, drill bit stand and convenient steel carrying case. 84PE9293

47⁹⁵

\$5 DOWN
COMPLETE KIT

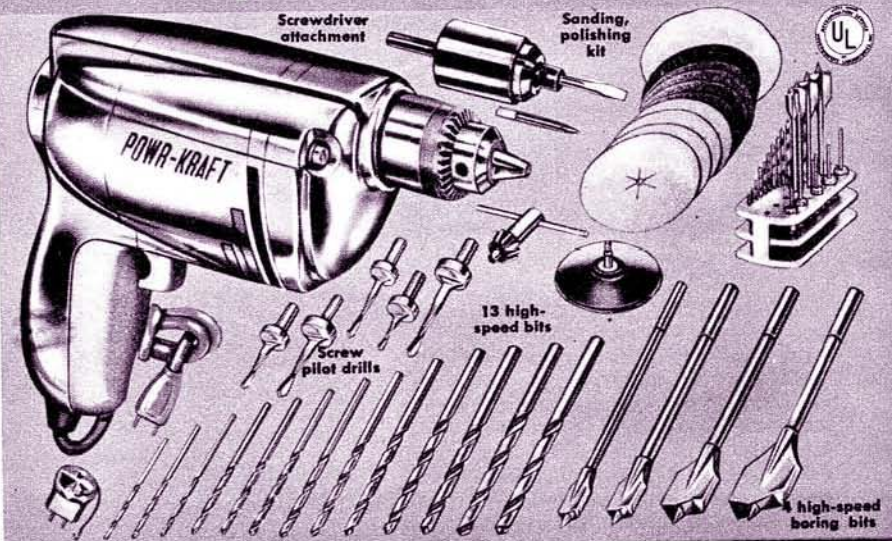

Your best 1/2" drill buy

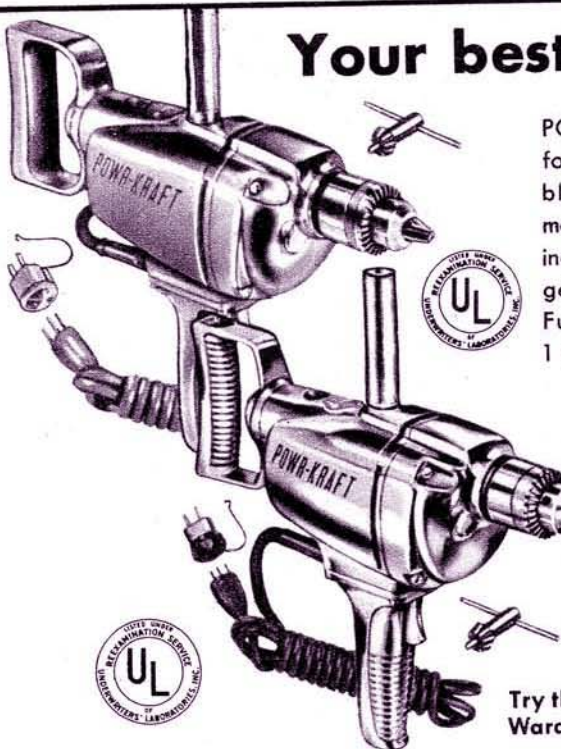

POWR-KRAFT heavy duty model. Ideal for continuous operation. 4-way reversible spade handle. Powerful 3/3-HP motor runs on full-ball and needle bearings: has Cutler-Hammer lock-type trigger switch. No-load speed 600 RPM. Fully guaranteed for 1 year. 84 PE 9273 **44⁹⁵**

POWR-KRAFT 1/2" utility model. Powerful 1/2-HP motor with ball and bronze bearings. Provides extra power, low speed and extra capacity for any operation. No-load speed 550 RPM. Fully guaranteed for 1 year. 84 PE 9272 **32⁹⁵**

Try these tools yourself—come in and ask Wards salesman to demonstrate them.

Drill Accessories



16.95

Right-angle drive attachment for 1/2" drills. Delivers double or half normal speed. Use in close quarters. 84 PE 9315

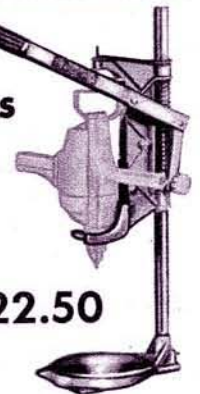

22.50

Drill stand converts any 1/2" drill into drill press. Spindle travels 4 1/2". Drills to center of 6" circle. 84 PE 9274



Get extra uses from your drill

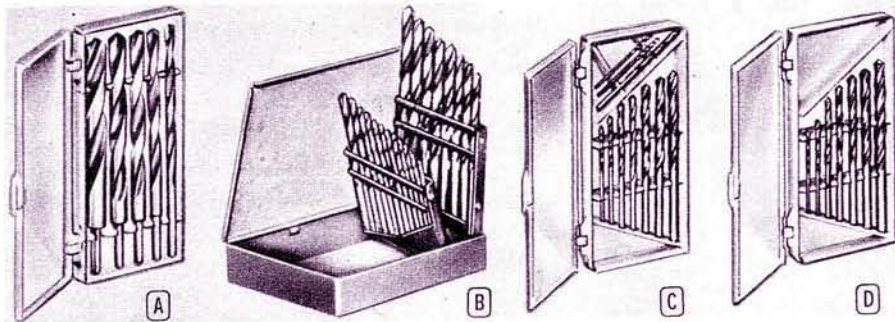

POWR-KRAFT bits drill faster, last longer! No finer quality. Precision ground, high speed drills stay sharp longer. Recommended for steel or wood. Use in any POWR-KRAFT drill. Carbon steel drill bits for use in hand or low speed drills—use for wood or soft metals.

A 5-piece drill bit sets. 1/2" round shanks. Sizes: 1/4" to 1/2" by 16ths. High speed steel 84 PE 4508.....4.98 Carbon steel set. 84 PE 4506.....3.29

B 21-piece high-speed drill set. Sizes from 1/16" to 3/8". 84 PE 4513.....13.95

C 10-piece straight shank sets. 10 most used sizes from 1/16" to 1/4". In plastic box. High speed drills. 84 PE 4549.....3.98 Carbon steel drills. 84 PE 4548.....2.19

D 7-piece straight shank drill sets High speed steel. 84 PE 4503.....2.98 Carbon steel set. 84 PE 4502.....1.59

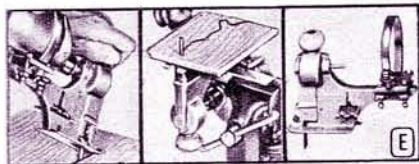

E Jig saw attachment converts your 1/4" or 3/8" drill into portable jig saw. Cuts metal, plastics, or wood up to 2 x 4's; even cuts embedded nails. Cuts curved or straight. Mount in bench vise and use as stationary saw. Makes openings without starting holes (note views above). Saw-dust blower keeps cutting line clear of sawdust. Comes with 6 assorted blades. 84 PE 9317. 9.95 Extra blades for jig saw attachment Wood blades 84 PE 9309.....6 for 1.90 Metal blades 84 PE 9318.....6 for 1.60

F POWR-KRAFT 1/4" Drill stand

Converts 1/4" or 3/8" drill into easy-to-operate, accurate drill press. Fast-acting clamps hold head to column. Drills to center of 8" circle, spindle travels 2". Rack and pinion gear and V-way slide for smooth, easy feed. Depth gauge and stop. Adjustable thrust screw takes load on end of drill. 1 1/4" diameter steel column. Holes in base for easy mounting. Real value! 84 PE 9245.....12.50

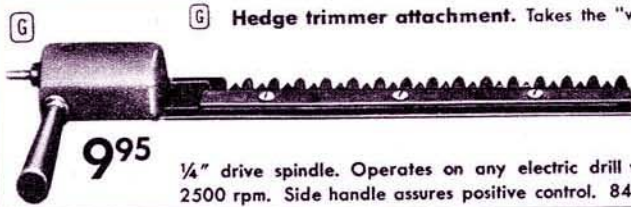
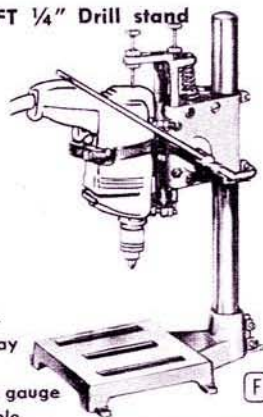

G Hedge trimmer attachment. Takes the "work" out of trimming. Clips shrubs, branches, twigs, quickly, easily. Precision ground 10" tempered alloy steel blade.

1/4" drive spindle. Operates on any electric drill with speed of 800 to 2500 rpm. Side handle assures positive control. 84 PE 9269.....9.95

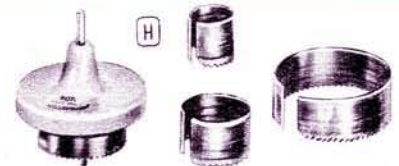

H Hole saw attachment for fast and neat carpentry, plumbing, sheet metal or decorative work. Cuts large circular holes in any kind of stock—wood, plastic, soft metals up to 3/4" in depth. Set consists of 4 high-carbon steel blades—1, 1 1/2, 2 and 2 1/2" diameter. Lightweight—easy to use in any 3/8" or 1" electric drill. 84 PE 9324.....5.49

J 4-piece high speed wood boring bit

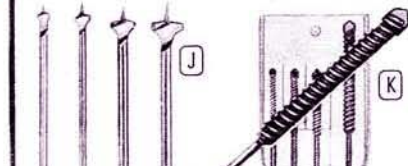

set fits all electric drills. 3/8, 1/2, 3/4 and 1 inch sizes. 84 PE 4520.....set 2.98

Individual wood boring bits. Choice of 3/8, 1/2, 3/4 or 1-in. 84 PE 4521.....ea. 79c

K 4-piece masonry drill set. 1/4, 3/8, 1/2 and 3/4-in. sizes. Carbide-tipped steel. Fast spiral flutes. Use in concrete, plaster, etc.; hand or power drill. 84 PE 4518.....set 2.98

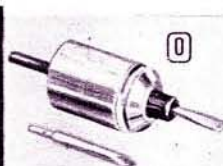

O Screwdriver attachment. Pressure engages friction clutch. Drives screws to 3/16" diam. Phillips and straight bits included. 84 PE 9357.....4.79

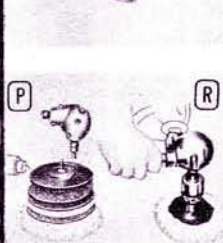

P Right angle drive kit. Has backing pad, 4 discs and sheepwool bonnet. Fits any 1/4" chuck. 84 PE 9312. 6.49

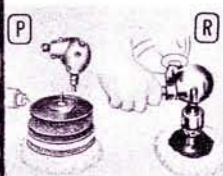

R 5" polishing sander kit. Rubber backing pad, 3 sanding discs, sheepwool polishing, buffing bonnet. Fits 1/2" chuck. 84 PE 9329. 1.39

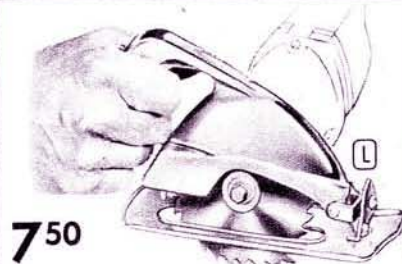

750

L 4" saw attachment converts 1/4" drill to power saw. Tilts to 45° 4" combination—blade adjusts for depth of cut to 1". 84 PE 9232.....7.50 Extra 4" blade. 84 PE 9250.....1.39



1095

M Planer attachment. Use with high RPM drill. Planes soft or hardwood—with or across the grain. Adjust depth from any type cut. Cutting width 1 3/4". Perfectly-balanced, easy to handle. Has spiral flute cutter; won't be deflected by knot, bad grain. 84 PE 9319.....10.95

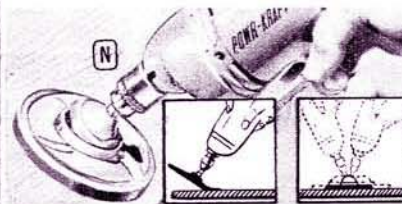

N New swivel disc sander. No more digging or gouging so often found with other sanding attachments. This multiple-use tool for the home workshop has a flexible joint that lets you sand and polish with speed and ease. Produces plane-like smoothness. See it at your nearest Montgomery Ward store. 84 PE 9384.....4.79

KROME-A-LOY blades last 3 to 5 times longer!



Wards has the right blade for every use

A, B, C POWR-KRAFT krome-a-loy blades. Finest chrome vanadium steel—retain cutting edge 3 to 5 times longer. Precision filed, set by hand. Won't bind. Individually tensioned, automatically set and sharpened. Perfectly uniform.

A POWR-KRAFT plywood blades. Finely set teeth to cut plywood, wall-board, etc. No splitting, chipping, ragged edges on any material. 6" blades have 180 teeth.

B POWR-KRAFT all-purpose combination blades. Tensioned for narrow kerf cuts and even edges. Flat ground, heat treated. Hand filed, set teeth.

C POWR-KRAFT nail-cutting saw blades. For cutting lumber having occasional embedded nails and wire. Hard steel, tempered by electric furnaces and tensioned to exacting specifications. Each individually hand set and filed.

D Carborundum "MX" cut-off wheels. Silicon carbon abrasive. #5244 for quick-cutting of brick, tile, etc. #5243 for steel, brass, cast-iron, etc. 3/8" thick, cotton fiber and abrasive grain with resin bond.

E New tungsten carbide cutting and sanding wheels. You can saw, sand, notch, plough, dado, shape without changing blade. Have no teeth; never need to be sharpened. Tungsten carbide particles copper-brazed to edge and sides do the job! Use on wood, plastics, any material except metal.

Cat No.	Diam.	Hole In.	Fit Saws	Each
A	6 in.	1/2 sq.	8950	\$1.89
84 PE 6991	6 1/4 in.	1/2 sq.	8926, 8927, 8940	1.89
Plywood	6 1/2 in.	1/2 rd.	8937, 8938, 8941	2.09
	4 1/4 in.	1/2 rd.	8925, 8935	1.39
	6 in.	1/2 sq.	8950	1.89
B	6 1/4 in.	1/2 sq.	8926, 8927, 8940	1.89
84 PE 6990	6 1/2 in.	1/2 rd.	8937, 8938, 8941	1.89
	7 in.	1/2 sq.	8952	2.19
	8 1/2 in.	1 3/8 sq.	8954, 8956, 8955	2.85
Combination	6 1/2 in.	3/8 rd.	B & D U-63	2.19
	7 1/4 in.	3/8 rd.	B & D U-73	2.29
	8 in.	3/8 rd.	8997, B & D U-83	2.89
C	6 in.	1/2 sq.	8905	2.39
84 PE 6992	6 1/4 in.	1/2 sq.	8926, 8927, 8940	2.39
Nail Cutting	6 1/2 in.	1/2 rd.	8937, 8938, 8941	2.39
	7 in.	1/2 sq.	8952	2.69
D	6 in.	1/2 rd.	8937, 8938, 8941	2.15
84 PE 5244	6 in.	1/2 sq.	8926, 8927, 8940	2.15
or	7 in.	1/2 sq.	8953	2.85
84 PE 5243	7 in.	1 3/8 sq.	8956, 8954	2.85
	8 in.	1 3/8 sq.		3.65
E				
84 PE 4103	8 in.	1/2 and 3/8 rd.		7.50
84 PE 4104	6 1/2 in.	1/2 and 3/8 rd.		5.49

POWR-KRAFT chain saw attachment cuts logs fast, without effort

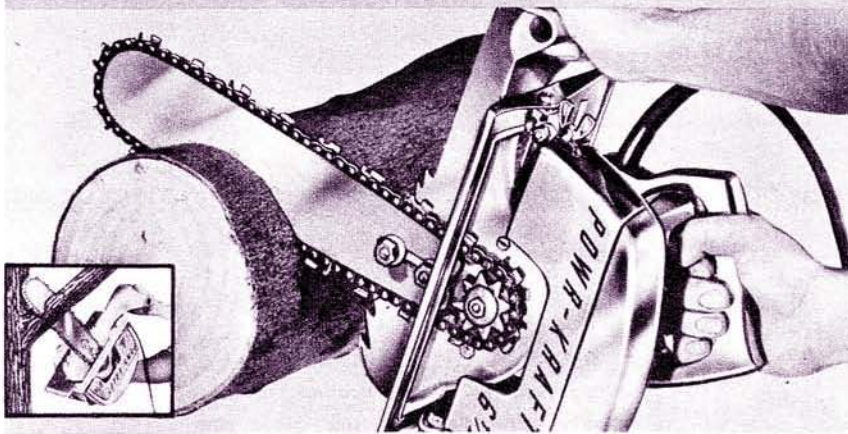

29⁹⁵
\$3
DOWN

- Just a small investment doubles the use of your POWR-KRAFT saw
- Trims trees, cuts logs fast, easy
- Bores through walls and ceilings
- Heavy duty construction throughout
- Built for rough, constant usage

Due to transportation costs, prices may vary in certain areas.

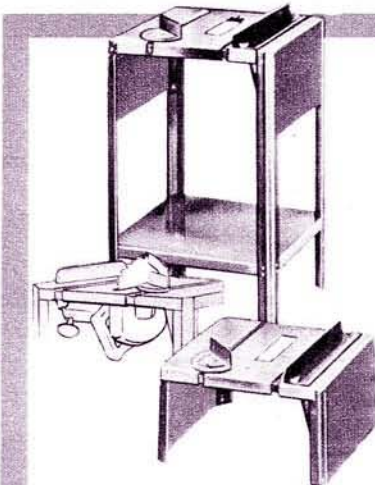

STEEL TABLES FOR SAWS

Here's the cheapest way to own both a bench saw and a portable saw. Converts POWR-KRAFT saws #8937 and #8941 into tilting arbor bench saw! Saw bolts easily to big 16 x 21 1/4" table surface. Has miter gauge and adjustable rip fence. Built-in receptacle and on-off switch.

Floor model saw table
84 PE 8968.....19.95

Bench model saw table. Bolts to work table. 84 PE 8967...14.95

Attach this unit to your POWR-KRAFT 6 1/2" saw and you have a chain saw that will "size for size" compare with any regular chain saw. Easy-to-handle for felling trees in wood-lots, cutting cordwood, fence posts; for building construction, industrial or maintenance jobs. 9" case hardened cutter bar. Standard chipper type chain cuts toughest wood with ease. Takes only a few minutes to remove attachment from 6 1/2" saw and to replace circular saw blade. Complete, ready to install. Fits only POWR-KRAFT saw models #8937, 8938, 8941.

84 PE 8970.....**29.95**

Replacement chain for above POWR-KRAFT saw attachment. 84 PE 8971.....**12.50**

Compare with other saws priced at over \$60!

POWR-KRAFT 6½" FOR PROFESSIONALS

Same capacity as
most 7" saws

\$44⁹⁵
\$5
DOWN

- Your best buy—more features, more savings
- Full ball and needle bearing construction
- "Safety clutch" protects both you and saw
- Full 1-hp motor power for toughest jobs

POWR-KRAFT 6½" heavy duty saw. Wards finest heavy-duty 6½" model. The RIGHT saw for professional builder or home craftsman. Rugged and powerful for fastest, smoothest cutting ever! Big 6½" blade provides capacity of most 7" saws—cuts 2" raw lumber easily—even at 45° angle. Cuts 2 x 4" easily. Has bevel index for accurate cut-off; precision-cut spur gears—forced air cooling. Telescoping blade guard. Blower keeps cutting line free of sawdust. "Safety Clutch" allows blade to stall if saw is overloaded; motor continues to run at full speed—won't burn out. Includes adjustable rip fence, 6½" combination blade, 10-ft., 3-wire cord. Full one-year guarantee. 84PE8941.

Try these tools yourself—come in and ask Wards salesman to demonstrate them.

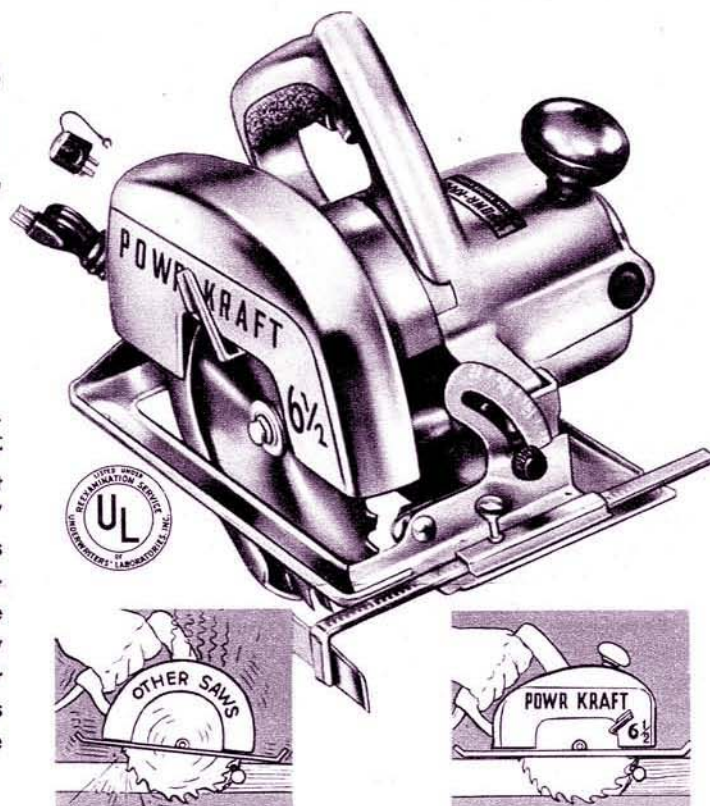

When blade on conventional saws are suddenly stopped, motor often burns out.



POWR-KRAFT safety clutch prevents motor burn-out, protects you from kick-backs.

Slices through boards 28 times faster than by hand

SPECIALLY DESIGNED FOR HOME WORKSHOPS

Compare with others
at higher prices

\$34⁹⁵
\$5
DOWN

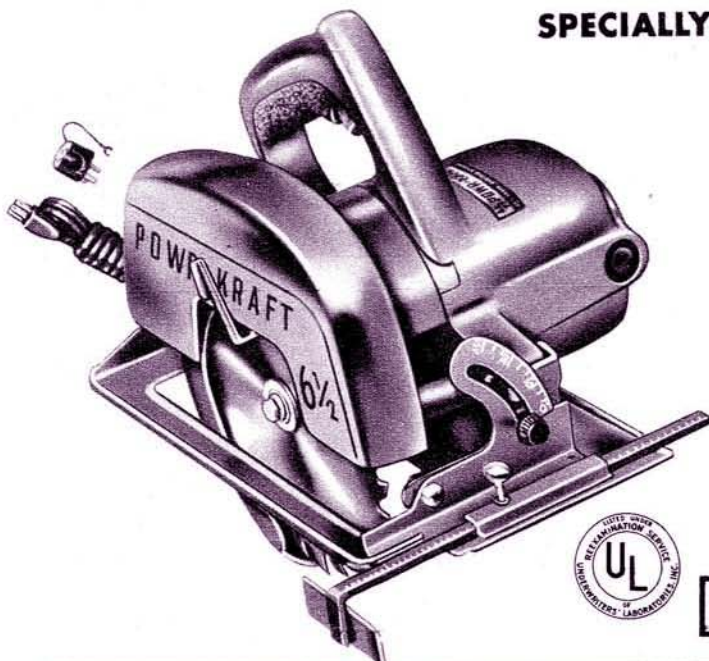

POWR-KRAFT 6½" utility saw. Just right to handle all the requirements of jobs around the house. Compare size, capacity and price with any other saw on the market. POWR-KRAFT 6½" saw offers more to the home owner at a really low price! Powerful, yet lightweight—weighs only 11-lbs. Has extra cutting capacity—up to 2¼" at 90°; 1⅞" at 45°. Will cut 2 x 4 rafters even at 45°! UL approved ¾-hp motor. No-load speed 4700 rpm; full-load 3200 rpm. Self-oiling precision bronze bearing construction throughout. Complete with 10-ft. 3-wire cord and 6½" combination blade and rip fence. Guaranteed one year against defects in material and workmanship. 84 PE 8937.

Due to transportation costs, prices may vary in certain areas.

Build while you pay.
Only \$2 to \$5 down
and as little as \$5 a
month.



Handy steel carry case protects your saw. Room for rip fence and extra blades. Fits all POWR-KRAFT 6½" saws. 84 PE 8949.....6.95

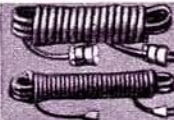

Rubber-covered extension cords.
15-ft., 16-ga. 3 wire 83 PE 1279 3.98
25-ft., 14-ga. 3 wire 83 PE 1270 6.98
25-ft., 16-ga. 2 wire 83 PE 1271 2.49

New **POWR-KRAFT** 7½" professional saw

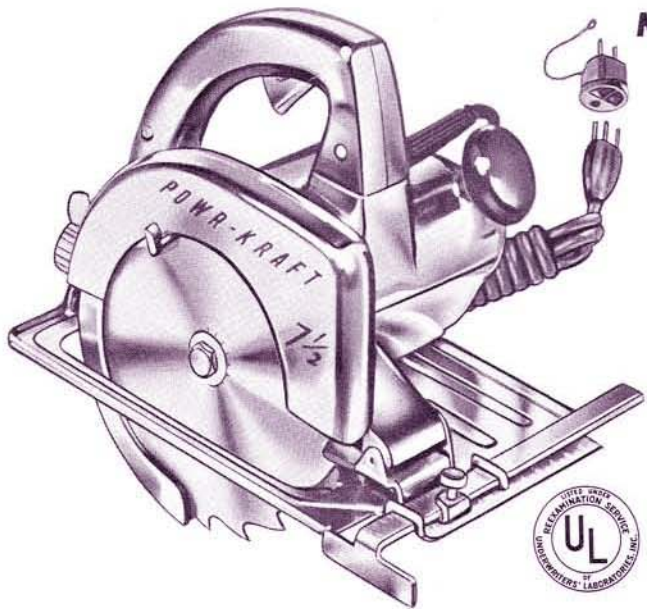

MEETS RUGGED INDUSTRIAL REQUIREMENTS

Compare with other
saws at \$84!

64⁵⁰
\$5 DOWN

- Wards extra heavy-duty big capacity model
- Precision ball and needle bearing construction
- UL approved. Guaranteed for one full year

For the carpenter or contractor . . . easily handles all professional building requirements. Cuts to 2⅞" at 90°, up to 2⅛" at 45°. 1¼-HP motor actually develops over 2 HP—provides all the power needed for the toughest jobs—assures years of trouble-free performance. Extra large steel base plate. Aluminum-alloy frame perfectly-balanced. Blower keeps line free of sawdust. With 10-ft. 3-wire cord and 7½" POWR-KRAFT combination blade. Graduated rip guide. 84 PE 8939

Fast-cutting **POWR-KRAFT** heavy-duty jig saw



42⁹⁵
\$5 DOWN

- Longer blade provides 25% greater blade-life
- Fast-cutting—3500 long ⅝" strokes per minute
- Two-position shoe permits cuts to sheer walls

Compare with saws selling for \$10 more! Most versatile—cuts wood, plastic, metals—circles, scrolls, openings—rips large sheets, even 2x4 lumber! Ball bearing construction. Includes rip and circular guide, 3 blades. Full 1 year guarantee. 84 PE 8933

Blades for cutting metal 84 PE 8944. 4 for 1.98. For coarse wood 84 PE 8945 4 for 2.25. For fine wood. 84 PE 8946 4 for 1.65



Self-starting cuts



Pattern cuts

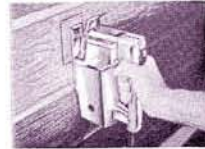

Box cutting

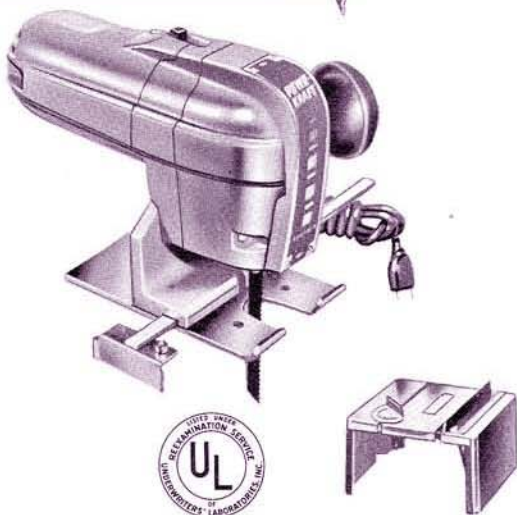

POWR-KRAFT utility sabre saw

- Rip and circle guide sawdust blower—UL approved
- Fast cutting — 2650 ⅝" strokes per minute
- Use as portable saw or bench model (see table below)

Specially designed for the home workshop—will handle all requirements around the home. Has large 2" cutting capacity. Cuts holes, patterns, straight or curved lines. Adjustable shoe for cutting 45° angles. Guaranteed 1 full year. Complete with 3 blades. 84 PE 8930

Wood cutting blades 84 PE 8909.. 5 for 1.39
Scroll blades 84 PE 8910..... 5 for 1.39
Metal cutting blades 84 PE 8911.. 3 for 1.39

25⁹⁵

POWR-KRAFT sabre-saw table converts above saw into a versatile bench model sabre saw in a jiffy. 84 PE 8908.....**9.95**

Why pay more than \$200?

AT WARDS
ONLY

119⁵⁰
55
DOWN

FOR RADIAL-ARM SAW
AND PORTABLE SAW



Does more than 100 operations

Portable—carry it to the job

Crosscut

Rip

Bevel

Compound miter

Dado

Miter

Drum sand

Sand

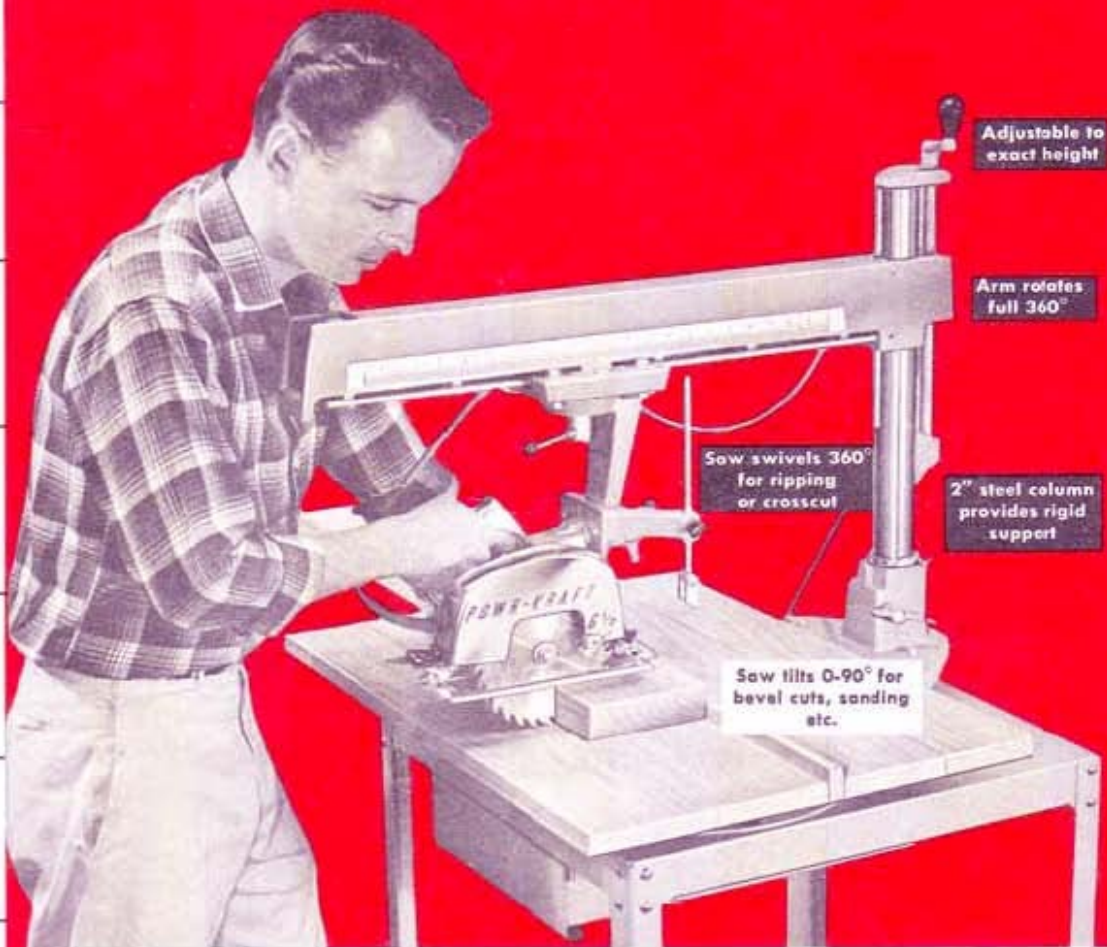

Adjustable to exact height

Arm rotates full 360°

Saw swivels 360° for ripping or crosscut

2" steel column provides rigid support

Saw tilts 0-90° for bevel cuts, sanding etc.

NEWEST, MOST-VERSATILE TOOL EVER!

POWR-KRAFT 2-Tools-in-1—at a sensationally-low price! Gives you a "shopful" of tools in a single compact machine! You have both a precision built radial arm saw—plus a heavy duty portable saw. Precision-built for professional or home use. Cuts 2" lumber, even at 45° angle. Rugged, powerful 1-hp motor. Radial Arm unit has heavy-welded steel base with 30x20x1-in. wood table. Ad-

justable rip fence. Arm rotates 360°; locks in any position. Carriage rides on precision-sealed ball bearings. Equipped with 6 1/2" POWR-KRAFT heavy-duty saw. Rips to center of 48" plywood. 84 PE 8906.

Radial arm only 84 PE 8906.....84.50

Steel stand 84 PE 8907.....24.95

Cut-off—sanding wheel 84 PE 4104..5.49

Sanding drum 84 PE 8912.....1.95

Visit Wards store and see this amazing addition to the *POWR-KRAFT* line



DM 9469—9/11/61