

Atlas

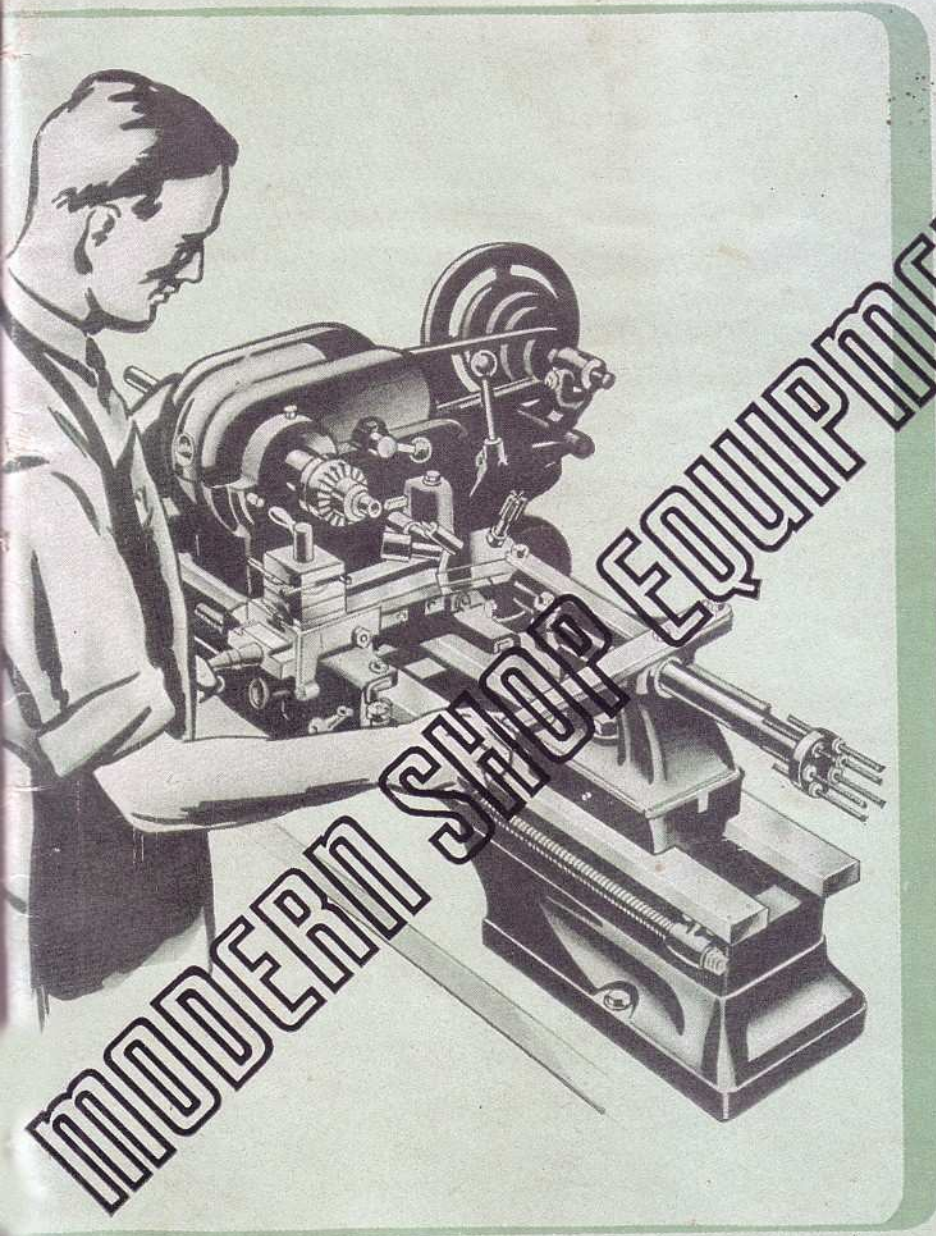

LATHES

PAGES 2-26

SHAPERS

PAGES 27-32

MILLING MACHINES

PAGES 33-42

DRILL PRESSES

PAGES 43-58

COOLANT SYSTEMS

PAGES 22-42-54-62

CATALOG NO. 45

MAY, 1945



Small-Parts Problems Solved

REDUCE COSTS AND BOOST

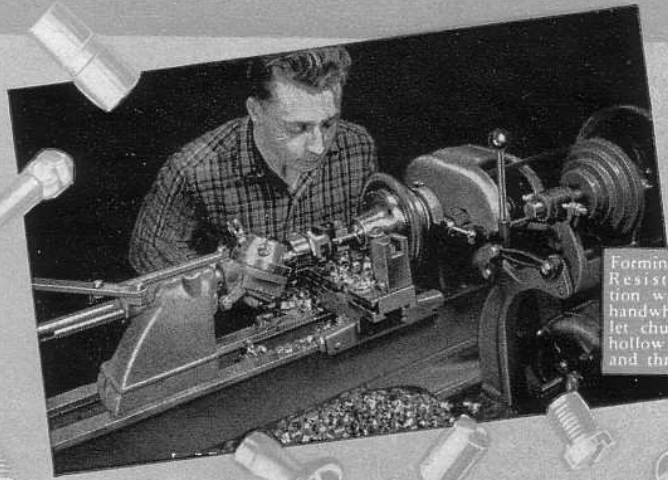

Forming special nuts at Resistoflex Corporation with stock held in hand-wheel operated collet chuck. Piece also hollow milled, tapped and threaded.

IN literally thousands of plants, Atlas lathes are cutting costs and boosting production on millions of small parts. The Atlas lathes were the first of modern design and low cost to be engineered with precision small parts production in mind. Today, their power and stamina stand tested and approved by the continuous grind of grueling production schedules. Hundreds of firms have found that Atlas lathes cut tool costs without sacrificing accuracy or dependable performance. If you have a small parts problem, check its specifications with the capacities of the Atlas lathes on the pages that follow. Selecting Atlas to match your requirements will bring you new production speed and economy.

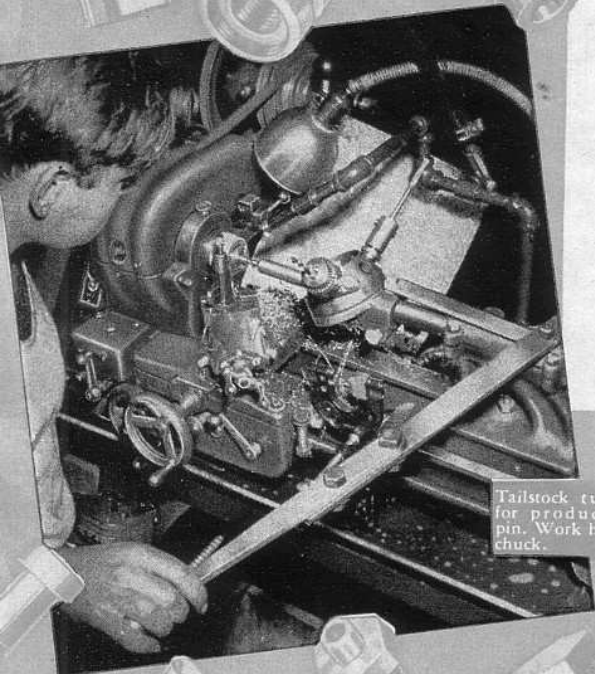

Tailstock turret set-up for producing special pin. Work held in collet chuck.

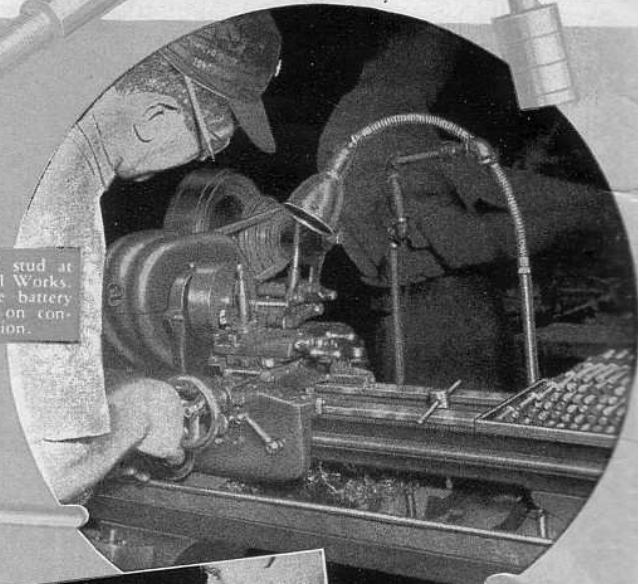

Turning special stud at Progressive Tool Works. One of a large battery of Atlas lathes on continuous production.



Reaming precision bronze fitting after facing and boring. Note special box fixture held in chuck.

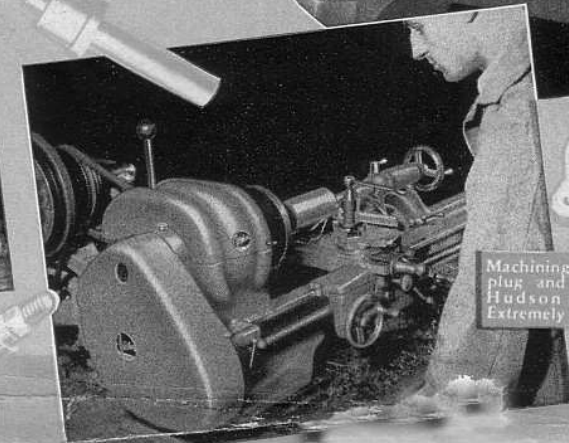

Machining combination plug and ring gage at Hudson Tool Works. Extremely close limits.

OUTPUT WITH COMPACT *Atlas* LATHES



Brewster Aeronautical Corporation has installed many Atlas lathes for accurate, efficient machining of small parts. Above, drilling small fittings.

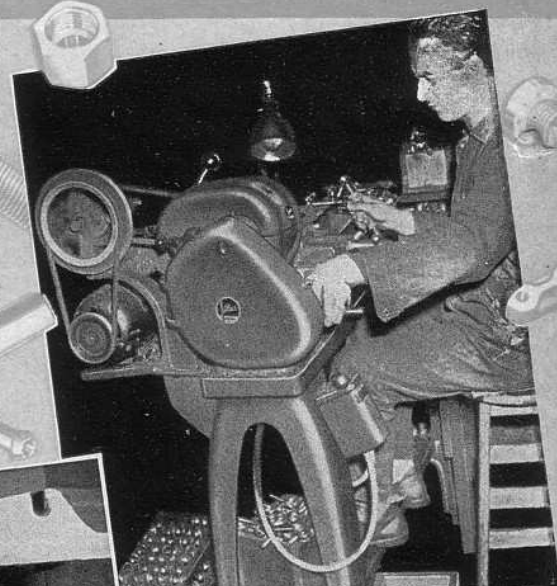

Machining forged terminals for aircraft, a continuous close-tolerance facing operation on economical basis.

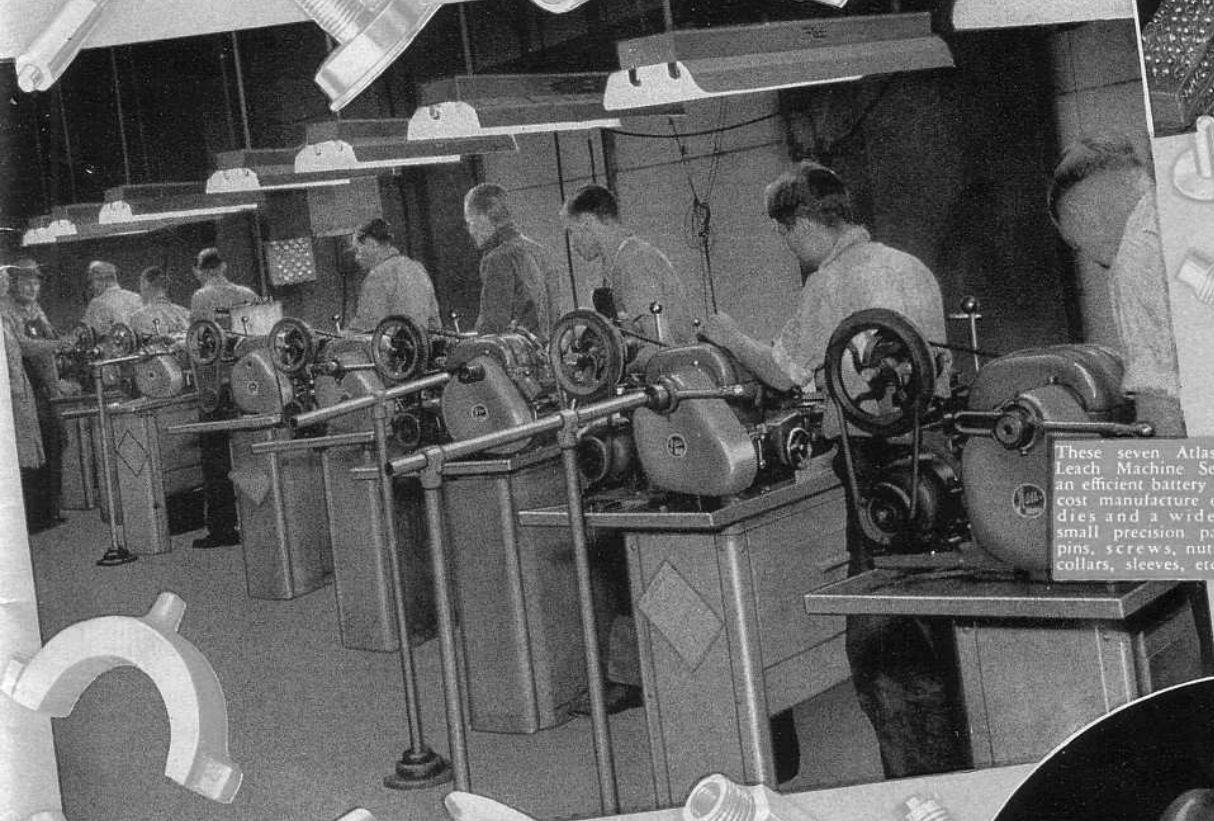

These seven Atlas lathes at Leach Machine Service form an efficient battery for the low cost manufacture of special dies and a wide range of small precision parts: studs, pins, screws, nuts, bearings, collars, sleeves, etc.

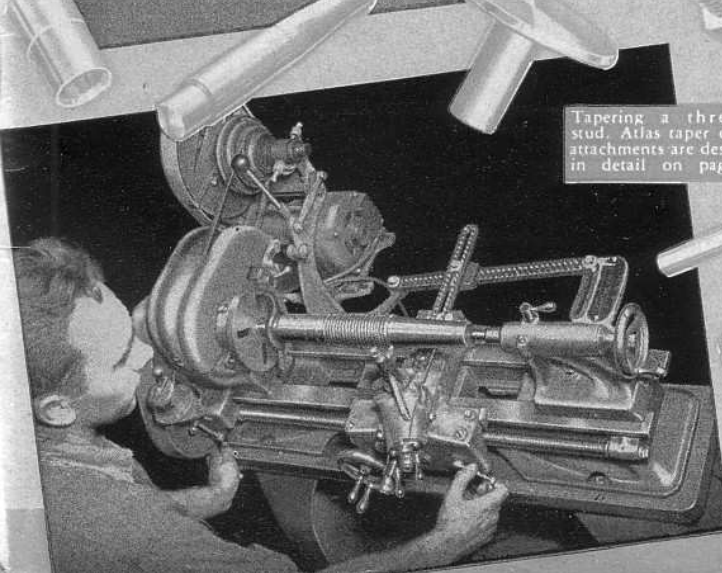

Tapering a threaded stud. Atlas taper cutting attachments are described in detail on page 18.

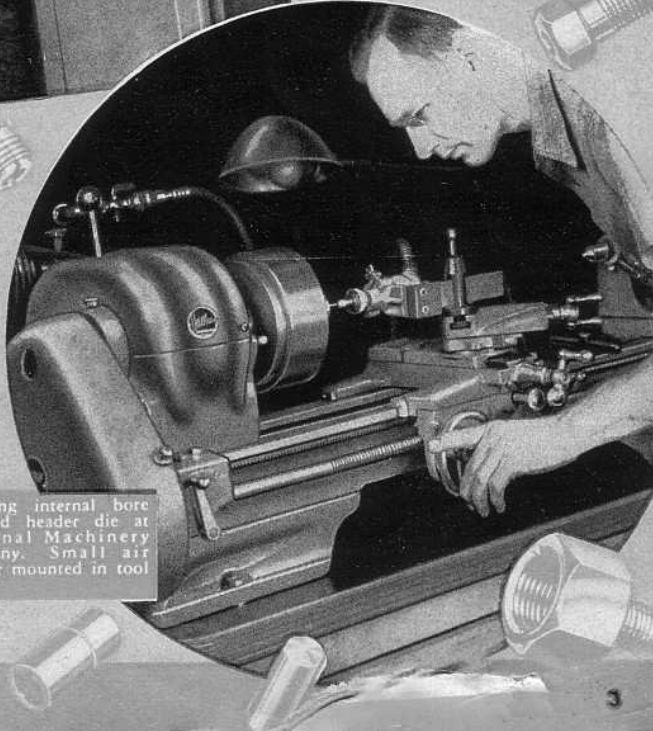

Grinding internal bore of cold header die at National Machinery Company. Small air grinder mounted in tool post.

RIGIDITY, ACCURACY and EFFICIENCY

- Reversible Automatic Power Cross and Longitudinal Feeds
- Precision Ground Bed Ways
- Custom-Built Spindle Bearings
- Complete V-Belt Drive — 16 Speeds
- Quick-Change Countershafts
- Extra Power for Heavy Jobs
- Wide Thread Cutting Range

THE rigidity and strength of Atlas lathes are the result of careful selection of materials and their scientific design. These pages show why the Atlas lathe is a production favorite in thousands of efficient plants. Each part for an Atlas lathe is machined on precision equipment of the latest design. All machining processes are checked with precision instruments and gauges to insure accuracy and uniformity. Further tests are made in each stage of assembly, and the completed lathe must pass actual working tests for precision. The rugged strength, long service life, and guaranteed accuracy necessary for modern production work are built into each Atlas lathe.

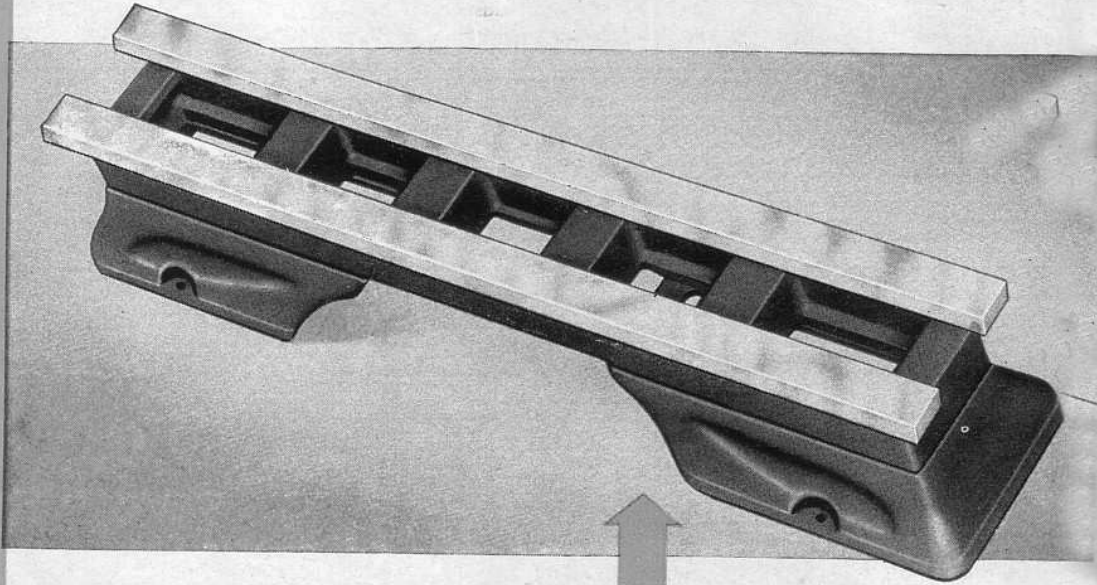
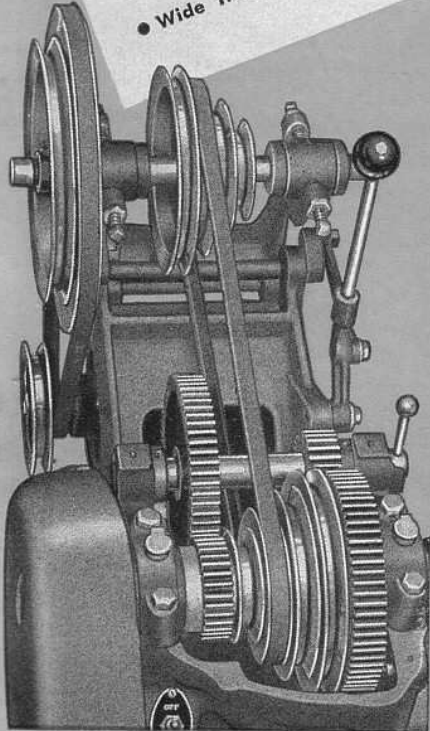

16 SPINDLE SPEEDS COMPLETE V-BELT DRIVE BACKGEARED POWER

Two-step pulleys from motor to countershaft and four-step pulleys from countershaft to spindle give 16 speeds between 28 and 2072 RPM with standard 1725 RPM motor — correct speeds for all modern lathe work: 8 speeds direct, 8 backgeared. Complete V-belt drive furnished. Combination of V-belts, V-pulleys, and adjustable countershaft delivers maximum power to spindle. Heavy oversized back gears reduce spindle speed, delivering power for heavy cuts and providing correct surface speeds for large diameter work. Back gear ratio is about 6 to 1. Backgear shaft runs on oilite bronze bearings. Iron safety guard covers back gears.

PRECISION GROUND BED

The foundation of long-lived accuracy in the Atlas lathe is the heavy precision-ground bed. The entire bed is a single heavy, massive, close-grained semi-steel casting. Box ribs every four inches brace the ways against torque. The wide, thick flat-type ways at top and inner ribs at bottom maintain rigid alignment under heavy loads. The ways are rough-milled, seasoned thoroughly and finish-milled, then given their final precision finish by special built precision grinding machines. Tops, bottoms and sides of the ways are ground and trued until all eight surfaces are aligned to within .001" in all planes.

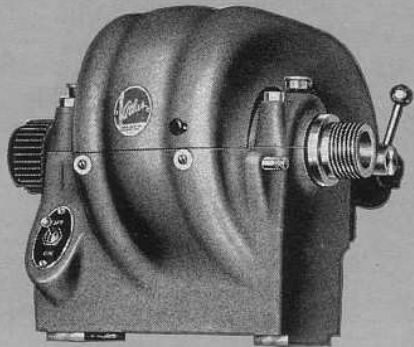

HEADSTOCK

is a heavy casting, ribbed and reinforced for permanent rigidity and strength. Accurately machined base fitted to bed ways, anchored solidly by clamp. 10 ampere motor switch built into casting.



HEADSTOCK SPINDLE

is machined from a solid bar of fine-grained steel, accurately ground to provide a perfect surface for the bearings. 1 1/2" diameter, 8 pitch NF threads, 25/32" hole through entire length.

WIDE SCREW CUTTING RANGE

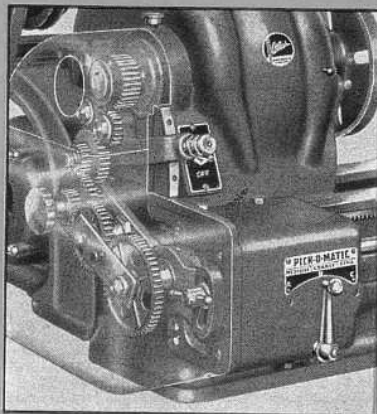

(Left) Phantom view of new "Pick-O-Matic" change gears, fully described on pages 8 and 9. The Pick-O-Matic gears save time on all threading and cutting operations by providing an extremely simplified method of making up the gear train.

(Right) Standard change gears for cutting all threads, right or left, from 4 to 96 per inch (NC, NF, Acme, square, Whitworth), standard metric threads from .5 to 7 mm. Hundreds of additional feeds available.

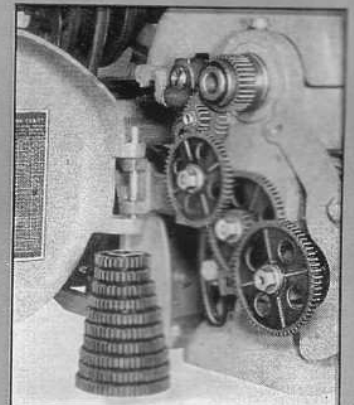

MAKE THE *Atlas* AN OUTSTANDING PRODUCER

CARRIAGE and COMPOUND REST

The carriage of the Atlas lathe consists of two heavy castings—the saddle, a broad base and rigid mounting for the compound rest—and the apron, a rugged housing for the power feed mechanisms. The saddle has six accurately machined full-length bearing surfaces on the bed ways, each $9\frac{1}{2}$ " long—two on the top bed ways, two on the side ways, and two on the bottom surfaces. Bottom bearing plates have laminated shims with four .002" and two .001" laminations, and the side bearing on the rear way has an adjustable gib. These adjustments allow accurate alignment of carriage with headstock and tailstock . . . even after long, hard duty. A heavy plate on each side of the saddle bears on bottom bed ways to prevent lift and twist.

Large handwheel on the apron controls reduction gears meshing with rack for hand-feeding carriage longitudinally. Carriage travels full length of bed. Four bed wipers, one at each corner of carriage. Dovetails of cross slide and carriage saddle are accurately machined and hand-fitted to insure accuracy on facing, milling, face-plate grinding, etc. Compound rest has $5\frac{1}{2}$ " bearing on cross slide—a rigid tool post support. Turns in complete circle and locks easily in any position. Top of cross slide machine-graduated through 180° . Cross slide travel is $6\frac{1}{2}$ ", tool post slide travel is $2\frac{1}{4}$ ". Milled T-slot holds drop forged tool post assembly—tool post slot takes $\frac{3}{8}$ " tool bits or holder for $\frac{1}{4}$ " bits.

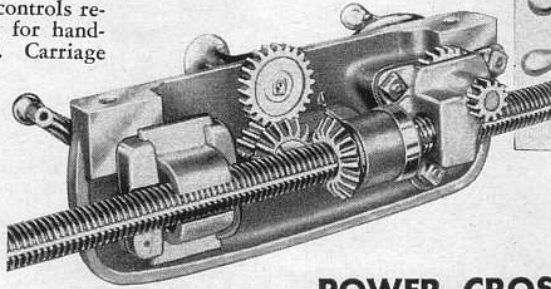

POWER CROSS and LONGITUDINAL FEED

Power cross feed speeds up all facing operations. A sliding spur gear controlled by a knob engages bevel-gear drive from the keyway in the lead screw with a gear on the cross slide feed screw. Power longitudinal feeds make quick, easy work of turning operations and simplify cutting right or left hand threads. The precision lead screw is $\frac{3}{4}$ " in diameter, 8 Acme threads per inch. Lead screw is driven by gear train from spindle gear.

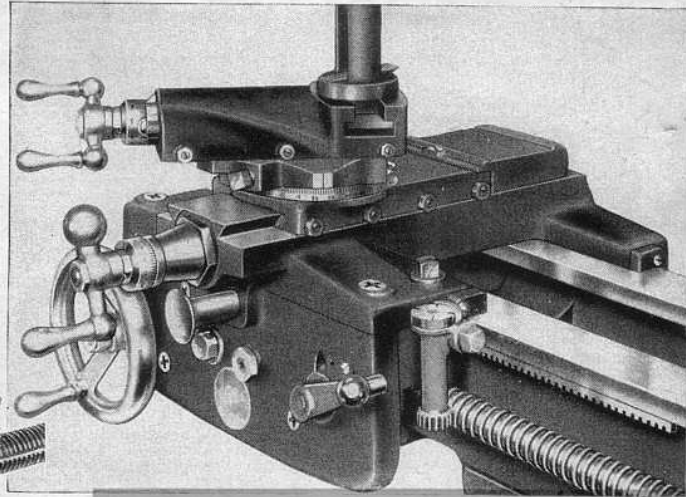

TAILSTOCK is accurately machined and fitted to bed ways to align accurately at any position. Inside bearing gibbed for take-up. Strong, rigid support for work.

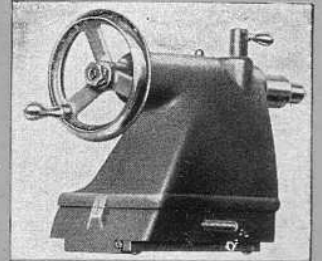

RAM is accurately ground, graduated from 0 to 3" by 16ths, bored for No. 2 Morse taper center. Has $2\frac{3}{4}$ " travel, 5" bearing on barrel, self-ejecting center.

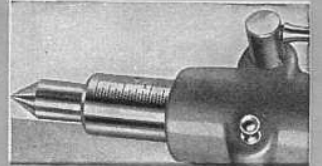

INDEXING MECHANISM. Face of the front spindle back gear has 60 evenly spaced indexing holes for such dividing operations as fluting, reeding, serrating, sprocket- and spoke-spacing.

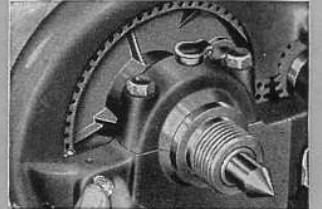

FEED SCREW COLLARS for cross and compound feed screws are micrometer graduated in .001ths. Set screw permits setting 0 at witness mark for accurate gauging of feed depth.



QUICK-CHANGE COUNTERSHAFTS

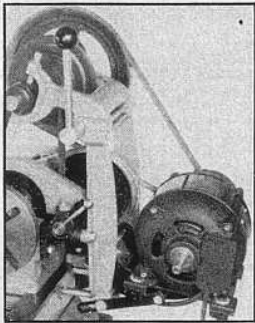

Atlas F-series lathes are available with the horizontal bench-mounted countershaft (right), or the vertical built-in countershaft (left) attached to headstock and bed. Both are "quick-change," with belt-tension lever easily reached for changes. Lever moves forward to release belts, back to engage. Countershaft spindle turns on Hyatt roller bearings. Two-step pulleys from motor to countershaft and 4-step pulleys from countershaft to spindle provide 16 speeds between 28 and 2072 RPM.

(Left) Vertical countershaft attached directly to headstock and bed.

(Right) Horizontal bench-mounted countershaft.

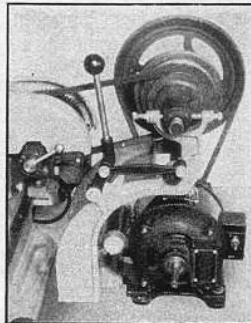

TWO TYPES of MODERN SPINDLE BEARINGS

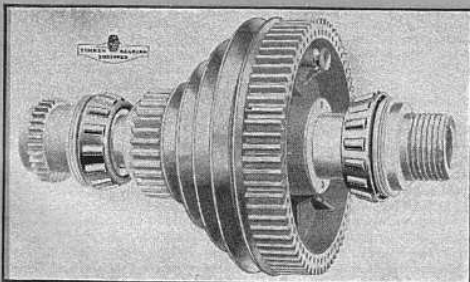

**TIMKEN
TAPERED ROLLER
BEARINGS**
(Page 6)

Recommended when Atlas F-Series lathes are to be used on production work demanding high spindle speeds over long periods. The tapered design of these modern anti-friction bearings, with their positively aligned rolls, maintains spindle alignment and carries both radial and thrust loads with minimum of friction.

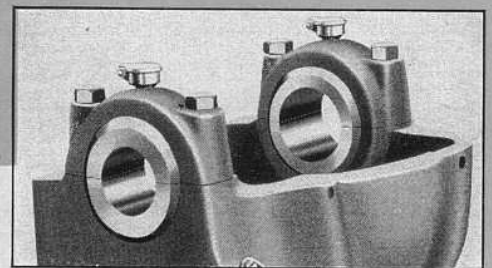

**BABBITT
SPINDLE
BEARINGS**
(Page 7)

Standard for Atlas F-Series 10" Lathes where sustained high speeds are unnecessary. These fine bearings, custom-bored for each lathe after headstock has been fitted to bed, are of the two-piece split-cap type used in larger machine tools and automobile engines. They assure a smooth running spindle and long, accurate life.

Atlas

F-SERIES

**COMPLETE
DESCRIPTION
PAGES 4-5**

RUGGED ★ ACCURATE

BOOST small-parts production, efficiently and economically, with these Atlas lathes, the first low-cost lathes to incorporate all of the modern construction features described on pages 4 and 5.

An Atlas meets every requirement of today's production shop—accuracy for the finest work, strength and power for



COMPLETE SPECIFICATIONS, PAGE 12

TIMKEN-BEARING F-Series Lathes WITH STANDARD CHANGE GEARS

The Atlas F-Series 10" lathes listed below are equipped with Timken tapered roller bearings for the headstock spindle. These modern anti-friction bearings have been specified for continuous production work by hundreds of the most efficient industrial plants. They are recommended whenever the spindle speed must be exceptionally high for long intervals—ideal for metal spinning, plastics machining, and woodturning as well as the usual work at normal speeds. Construction features, pages 4 and 5; complete specifications, page 12.

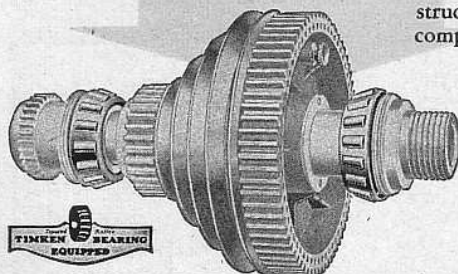

TIMKEN TAPERED ROLLER BEARINGS

Spindle with outer races removed to show how Timken tapered roller bearings maintain spindle alignment and carry both radial and thrust loads with minimum friction. Bearing bosses are custom bored.

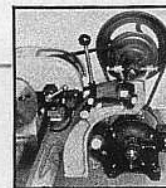

WITH HORIZONTAL COUNTERSHAFT



WITH VERTICAL COUNTERSHAFT

Length of Bed	Between Centers	Overall Length	Order No.	Shipping Weight less motor	Code Word	Order No.	Shipping Weight less motor	Code Word
36"	18"	40"	TH36	259 lb.	YEPEN	TV36	249 lb.	YENON
42"	24"	46"	TH42	271 lb.	YEPLA	TV42	261 lb.	YENUP
48"	30"	52"	TH48	279 lb.	YEPME	TV48	269 lb.	YEOXY
54"	36"	58"	TH54	284 lb.	YEPPOP	TV54	274 lb.	YEPAL
Complete Specifications — Page 12			Overall Depth — 26" Overall Height — 19"			Overall Depth — 21" Overall Height — 24"		

★ INSTANTLY REVERSIBLE AUTOMATIC POWER
CROSS FEED AND LONGITUDINAL FEED

★ CUSTOM BUILT SPINDLE BEARINGS
★ COMPLETE V-BELT DRIVE — 16 SPEEDS

10 inch BACKGEARED SCREW CUTTING LATHES

POWERFUL ★ EFFICIENT

heavy jobs, and many modern features essential for simple, efficient operation. For steady work on production jobs, the Timken-equipped F-series lathes (page 6) are recommended. For tool rooms and general utility, the babbitt-bearing models (page 7) are highly satisfactory.

Equipment suggestions for handling industrial turret lathe and screw machine work are shown on pages 10 and 11 — complete specifications, page 12.

with STANDARD CHANGE GEARS

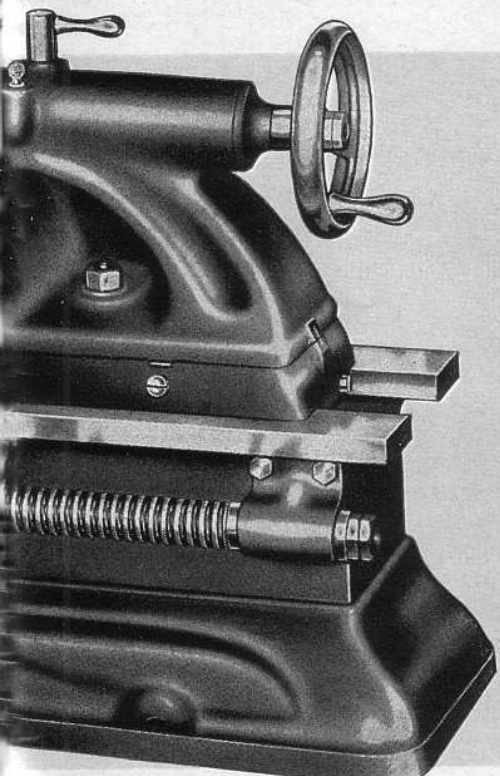

Left end of lathe with iron safety guard open, showing standard change gears, gear train, edge of threading chart.

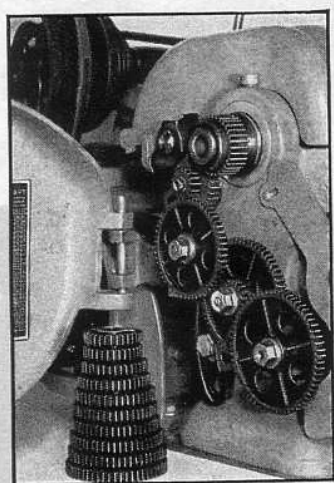

Threading chart for cutting all standard threads between .4 and 96 per inch and standard metric threads between .5 and 7 mm. (Actual chart is 7½" high.)

THREADING CHART

A-B-C-D ARE GEAR STUD POSITIONS
 # BACK POSITION (TOWARD HEADSTOCK)
 # FRONT POSITION (AWAY FROM HEADSTOCK)
 # D-DLX GEAR # 9'S SPACER # BLANK
 # 12 10TH GEAR IN BACK POSITION (24 TOOTH REVOLUTION SPACER)

STANDARD SCREWS	Pitch																																																						
3.175	1.25	1.5	1.75	2	2.25	2.5	2.75	3	3.25	3.5	3.75	4	4.5	5	5.5	6	6.5	7	7.5	8	8.5	9	9.5	10	11	12	13	14	15	16	17	18	19	20	22	24	26	28	30	32	34	36	38	40	45	50	55	60	65	70	75	80	85	90	96
METRIC SCREWS	Pitch																																																						
1.5	1.75	2	2.25	2.5	2.75	3	3.25	3.5	3.75	4	4.5	5	5.5	6	6.5	7	7.5	8	8.5	9	9.5	10	11	12	13	14	15	16	17	18	19	20	22	24	26	28	30	32	34	36	38	40	45	50	55	60	65	70	75	80	85	90	96		

FEEDS PER REVOLUTION OF SPINDLE

MECHANICAL FEEDS

MANUAL FEEDS

COIL WINDING FEEDS

THESE Atlas F-series lathes are equipped with standard-type change gears and threading dial for cutting all threads, either right or left hand, from 4 to 96 per inch, in the following standards: National Coarse (USS), National Fine (SAE), Acme, Square, and Whitworth. All standard metric threads from .5 to 7 mm. can be cut with the standard change gears furnished. Gear set-ups for these threads are shown on the pictorial threading chart on the inside of the gear train guard. Hundreds of additional feeds are available for screw cutting, coil winding, and special work. Slotted bracket and stud assemblies support the gear train as shown above. Complete instructions for gear train set-ups are described and illustrated in the Atlas "Manual of Lathe Operation" (see page 8).

BABBITT-BEARING F-Series Lathes WITH STANDARD CHANGE GEARS

The Atlas F-Series lathes listed below are equipped with headstock spindle bearings of high-speed babbitt. To assure positive alignment, these heavy duty bearings are accurately custom-bored by a special machine mounted in position on the bed ways after the headstock has been fitted to the bed. Laminated shims on each side of the bearings have five .002" laminations for take-up. Front bearing is 1½"; rear bearing, 1¾" long. Large capped felt-wick oil cups connect to oil grooves. These fine bearings insure a smooth-running spindle and long, accurate life.

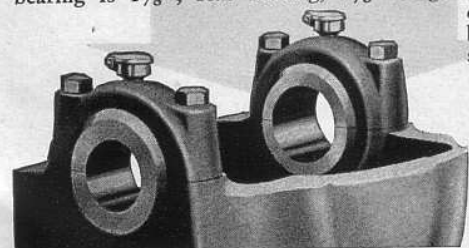

Custom-Bored High-Speed Babbitt HEADSTOCK SPINDLE BEARINGS

High-speed babbitt bearings of the two-piece split cap type used in larger machine tools and auto engines maintain accuracy and alignment under heavy loads. Custom bored after headstock has been fitted to bed.

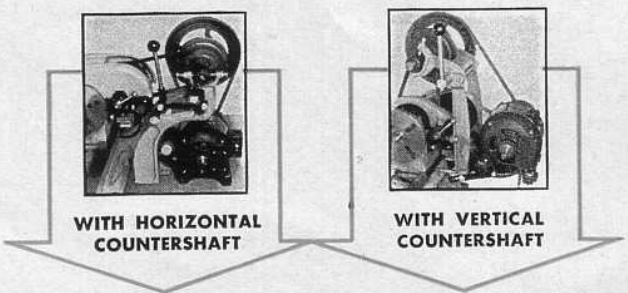

Length of Bed	Between Centers	Overall Length	Order No.	Shipping Weight less motor	Code Word	Order No.	Shipping Weight less motor	Code Word
36"	18"	40"	H36	259 lb.	YEKUL	V36	249 lb.	YEKIJ
42"	24"	46"	H42	271 lb.	YELAH	V42	261 lb.	YEKKO
48"	30"	52"	H48	279 lb.	YELHA	V48	269 lb.	YEKMY
54"	36"	58"	H54	284 lb.	YELIK	V54	274 lb.	YEKOK

Complete Specifications — Page 12	Overall Depth — 26" Overall Height — 19"	Overall Depth — 21" Overall Height — 24"
-----------------------------------	---------------------------------------------	---------------------------------------------

★ PRECISION GROUND BED WAYS
 ★ EXTRA POWER FOR HEAVY JOBS

★ WIDE THREAD CUTTING RANGE
 ★ 60-HOLE INDEXING MECHANISM

THE NEW PICK-O-MATIC CHANGE

NEW PICK-OFF GEAR MECHANISM PROVIDES FOR SIX FEEDS OR THREADS WITH EACH GEAR SET-UP

THE new Pick-O-Matic is an improved semi-quick change device which provides six different feeds or threads for each set-up of the gear train. Where the ordinary semi-unit provides only three different feeds, Atlas Pick-O-Matic makes available three additional feeds by merely shifting the position of the sliding gear to In or Out — all six without changing the gears on the gear train.

The Pick-O-Matic mechanism consists of a gear bracket and two-position sliding gear, a ratio-change gear box with shift lever, and a large, easy-to-read selector chart that automatically gives the information required for the thread or feed selected. (See Below) A tumbler gear lever controls the direction of carriage travel, and a two-piece iron guard with a spring-clip catch provides a close-fitting safety cover.

Easily Installed on Any "F" or "D" Series Lathe

This new time saving device can be installed on any "F" or "D" series Atlas Lathe now in use. Changeover can be made in less than an hour by any skilled mechanic; no special tools are necessary. Pick-O-Matic can also be ordered installed on any model "F" series Atlas Lathe at the factory.

Less Than 1 Minute For Set-Up

Pick-O-Matic *cuts to less than a minute* the time required to set up the gear train for standard threads between 4 and 240 per inch. No wrenches or tools are

required; no gear meshing — gear positions are automatically fixed. The Pick-O-Matic selector chart and the Pick-A-Gear rack eliminate the possibility of set-up mistakes.

With Pick-O-Matic, it is possible to change from any thread between 4 and 240 threads per inch to a fine feed *without* changing the gear train. The ratio change gear box provides three feeds or threads for each In or Out position of the sliding gear. Ratios are 2 to 1; 1 to 1; and, $\frac{1}{2}$ and $\frac{1}{4}$; $\frac{1}{8}$ and $\frac{1}{16}$. Thus, when the gear train is set up for any of the above threads, a proper feed is available without changing the gear train.

More Than 2500 Threads and Feeds Available

Pick-O-Matic does not in any way limit the odd thread with feed range capacity of an Atlas Lathe. More than 2500 different threads and feeds can be obtained by using the compound gear bracket on Atlas Lathes equipped with Pick-O-Matic. Threads between .7812 and 819.200 per inch, including metric threads between .25 and 7 mm.; feeds between 1.2800" and .0012 per spindle revolution — the greatest range available on any lathe.

The Pick-O-Matic manual furnished with each unit lists the set-up data for all these feeds and threads, and in addition, gives information on gear train arrangements for winding ten different types and 300 sizes of steel wire, magnet wire, and others.



EXAMPLE OF WORK RANGE OF PICK-O-MATIC CHANGE GEARS

Selected Instantly Without Changing Gear Train

Threads Per Inch	Feed Equivalent	Position of Sliding Gear	Ratio-Change Lever at	Gear at Position E	Gear at Position D
6	.1670"	OUT	B	48	48
12	.0830"	OUT	A	48	48
24	.0420"	OUT	C	48	48
48	.0210"	IN	B	48	48
96	.0104"	IN	A	48	48
192	.0052"	IN	C	48	48

NO CHANGE IN GEAR TRAIN

WIDE WORK RANGE FROM ONE GEAR TRAIN

The table at the left shows how Pick-O-Matic change gears multiply lathe efficiency by providing six different quick-change threads for each gear train, each instantly available by simply shifting the ratio-change lever and sliding gear positions (see page 9, Figures 3 and 4).

Notice in the example (left) that all of the six threads listed are obtained from the same gear train (48 tooth gear at Position E, and 48 tooth gear at Position D). With the sliding gear at "Out" position, any one of three threads (6, 12 or 24 per inch) may be selected instantly by shifting the ratio-change lever to B, A, or C. After changing sliding gear to "In", the three ratio-lever positions provide 48, 96 and 192 threads per inch.

Thus, six different quick-change threads and feeds may be selected from any Pick-O-Matic gear train by simply shifting the sliding gear and ratio-change lever. This sharply reduces time on job changeovers and, combined with an extremely wide odd-thread range, makes the Pick-O-Matic change gears an ideal solution for many of today's lathe production problems.

GEARS FOR *Atlas* TEN-INCH LATHES

ORDERING INFORMATION

No. 1200 PICK-O-MATIC CHANGE GEARS for Atlas F-series 10" lathes ($\frac{3}{4}$ " diam. lead screw). Furnished as shown with gear bracket, two-piece guard, fifteen gears, selector chart, Pick-A-Gear rack, and Hand Book for thousands of odd threads and feeds. When ordered with F-series lathe, Pick-O-Matic gears are installed at factory. Instructions for installing to F-series lathes in field are included in Hand Book. Code word YICOH, weight 66 lb.....

No. 1270 PICK-O-MATIC CHANGE GEARS for Atlas 10-inch lathes with $\frac{5}{8}$ " diam. lead screw. Furnished as shown with gear bracket, two-piece guard, fifteen gears, selector chart, Pick-A-Gear rack, Hand Book for odd threads and feeds, complete instructions for installation. Code word YICYK, weight 66 lb.....



(Left) Hand Book furnished with Pick-O-Matic gears gives data for thousands of odd threads and feeds.

(Right) Pick-A-Gear rack has slots for change gears. Furnished with Pick-O-Matic change gears.

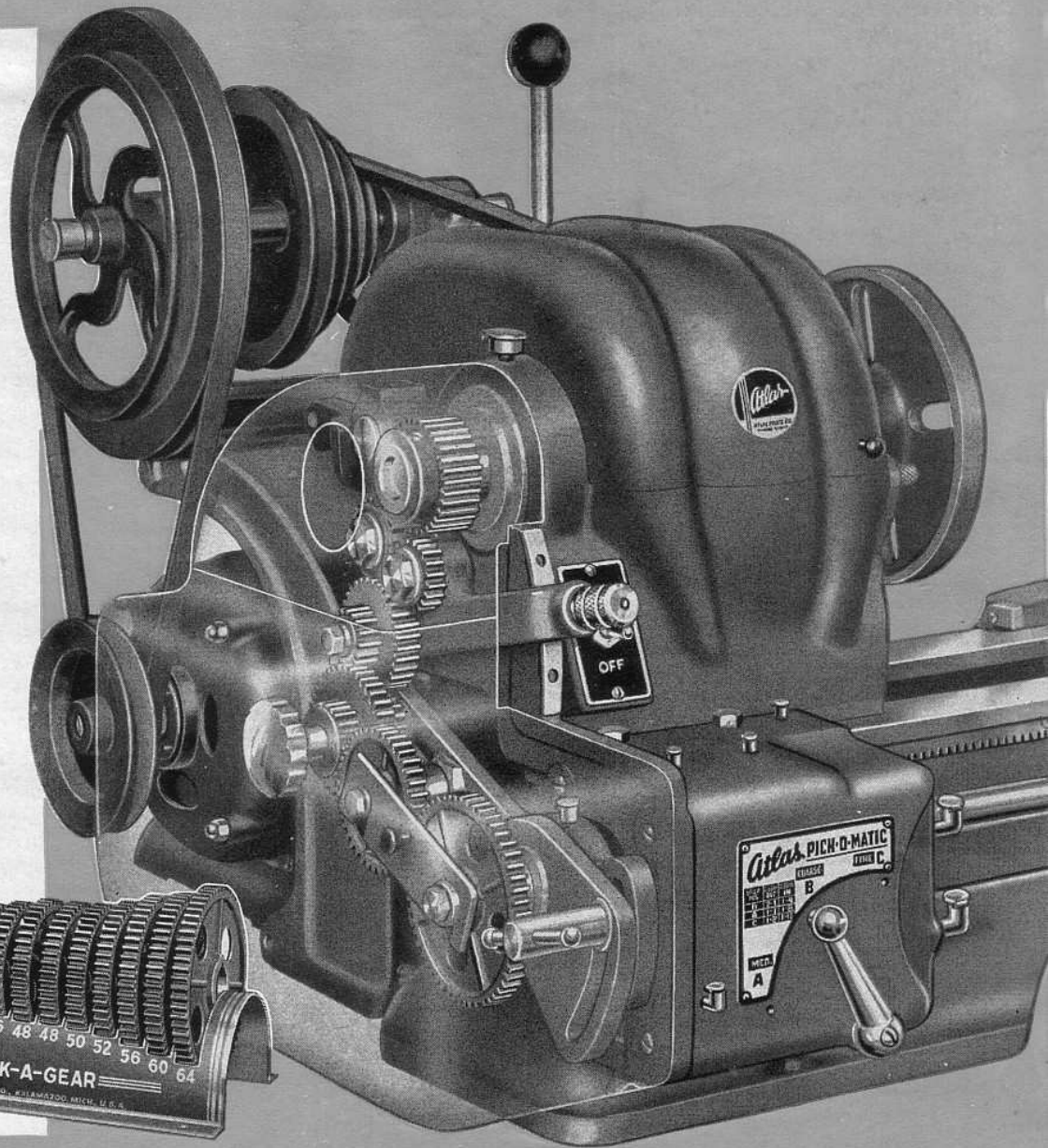

THE SIMPLIFIED PICK-O-MATIC METHOD OF MAKING UP THE GEAR TRAIN

For most common threads and feeds turn knob of selector chart to correct data. Refer to Hand Book for odd threads.

1

Take two gears from Pick-A-Gear rack and place on bracket positions E and D. Place yoke over gears. Complete set-up made without wrenches or tools.

2

Check position of sliding gear — in or out as shown on selector chart. Mesh gears and raise bracket to engage train. Tighten T clamp.

3

Shift ratio-change lever to position shown on selector chart: A (medium), B (coarse), or C (fine). Lathe is ready for threading operation.

4

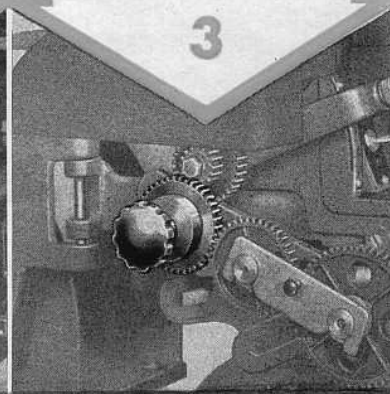
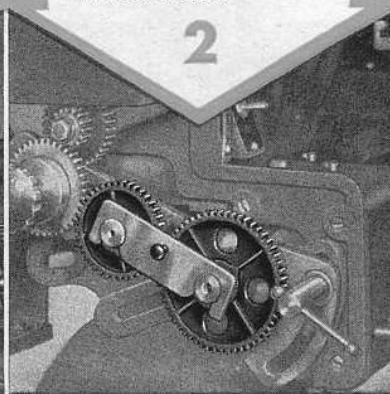

Atlas ACCESSORY RECOMMENDATIONS



WHENEVER duplicate operations are required on small parts, when runs are not long enough to warrant automatic tooling, and when production requires quick changeovers from piece to piece . . . *match the machine to the job!* Install compact profit-making Atlas lathes equipped with these assortments of rapid-production accessories.

GENERAL-PURPOSE ASSORTMENT HAS WIDE WORK RANGE

This Recommendation No. 1 for basic manufacturing is typical of many Atlas turret lathe-screw machines producing millions of small parts quickly, accurately and profitably. Careful selection of production accessories multiplies lathe efficiency and returns investment very soon by reducing unit costs.

Accessories in this group have been selected for versatility, all-around efficiency and accuracy control. The "Pick-O-Matic" (pages 8-9) speeds up all threading and automatic carriage feeding operations by simplifying make-up of gear train and permitting instant selection of one of six threads and feeds. Eleven different duplicate operations may be set up on carriage and tailstock turrets, each controlled by a separate stop gauge. Timken tapered roller bearings for lathe headstock spindle carry radial and thrust loads with minimum of friction.

Notice the extreme flexibility of Recommendation No. 1. Addition of lever-type collet chuck (page 11) converts the installation into an efficient hand-type screw machine for the rapid production of parts from bar stock up to 1/2" diameter. Or install an independent or universal chuck (page 19) and the result is a bench-type turret lathe for producing larger parts. Coolant equipment, floor stand or cabinet, and motor may be selected as required:

- Coolant Pumps.....Page 22
- Floor Stands and Cabinets.....Page 13
- Motors.....Page 13

RECOMMENDATION No. 1

No.	Description	Page
TH42	Atlas F-Series 10" Lathe with horizontal countershaft, Timken tapered roller bearings for headstock spindle.....	6
1200	Pick-O-Matic Change Gears.....	8-9
420HD	Heavy-Duty Reversing Switch.....	13
670	Plain-Type Carriage Turret.....	15
690	Multi-Stop Attachment.....	15
600	Tailstock Turret.....	15

Maximum Distance, face of tailstock turret to lathe spindle.....	20"
Longitudinal travel of cross slide:	
with Multi-Stop.....	19-3/4"
without Multi-Stop.....	21-5/8"
Overall length:	
with tailstock turret at extreme right.....	56-1/2"
with tailstock turret removed.....	47"
Swing over carriage turret slide.....	4-3/4"
Travel of tailstock turret.....	3-7/16"
Cross travel of carriage turret.....	6-1/2"
Tailstock turret ram, diameter.....	1-1/8"

Examples of turret lathe and screw machine work being handled efficiently and economically with Atlas lathes and equipment recommended on these pages.

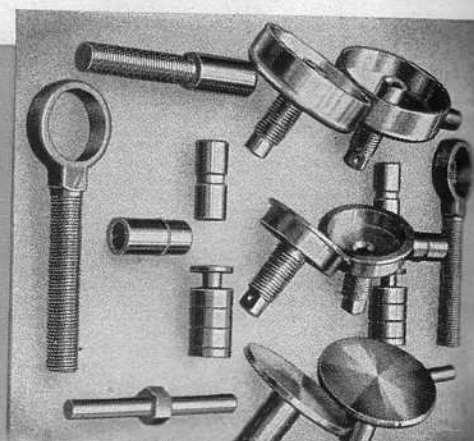
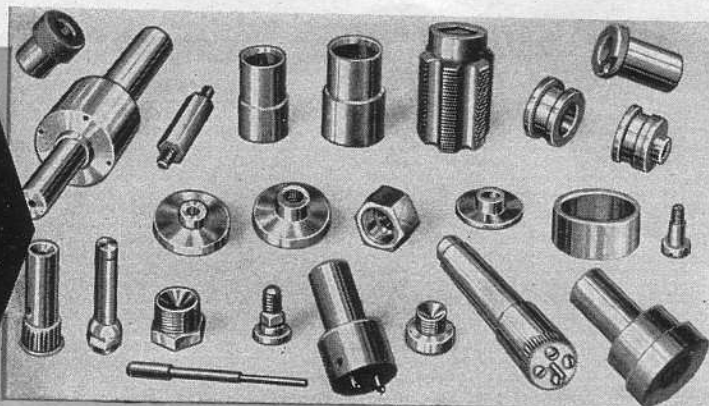

FOR TURRET LATHE-SCREW MACHINE WORK

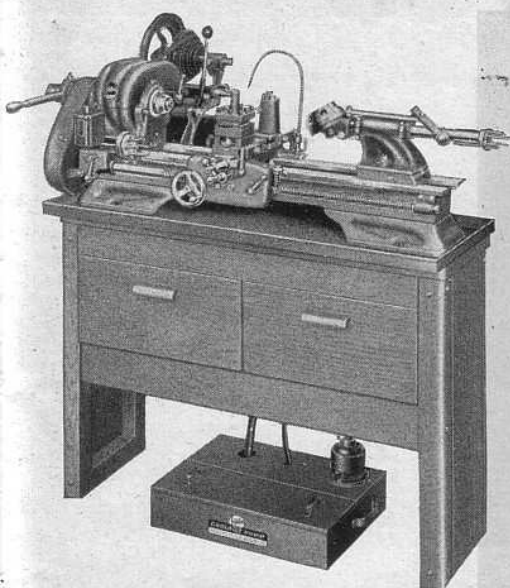

Atlas F-Series 10" lathe equipped as hand-type screw machine for rapid continuous small parts production with bar stock. Addition of chuck (page 19) provides also for turret lathe work.

No.	Description	Page
TH42	Atlas F-Series 10" Lathe with horizontal countershaft, Timken tapered roller bearings for headstock spindle.....	6
W101	Hardwood Floor Cabinet.....	13
10-775A	Oil Pan.....	22
420HD	Heavy-Duty Reversing Switch.....	13
900B	Lever-Type Collet Chuck.....	14
751	Holding Collets (specify diam.).....	14
548	Spindle Nose Cap.....	14
670	Plain-Type Carriage Turret.....	15
690	Multi-Stop Attachment.....	15
600	Tailstock Turret.....	15
W89	Universal Coolant Pump and Tank.....	22
W96	Coolant Feed and Return Lines.....	22
Hole through Spindle, diameter.....		25/32"
Capacity:		
round stock.....		3/4"
hexagon stock.....		5/8" across flats
square stock.....		1/2" across flats
Collet Capacity.....		1/2"
Overall Dimensions with Tailstock Turret at Extreme Right.....		
.....59" wide x 20" deep x 50-1/2" high		

RECOMMENDATION No. 2

CORRECT TOOLING insures profitable operation. These pages show Atlas lathe-and-accessory installations as specified for small parts production by many efficient manufacturing shops. The recommendations listed are adapted easily to meet individual requirements.

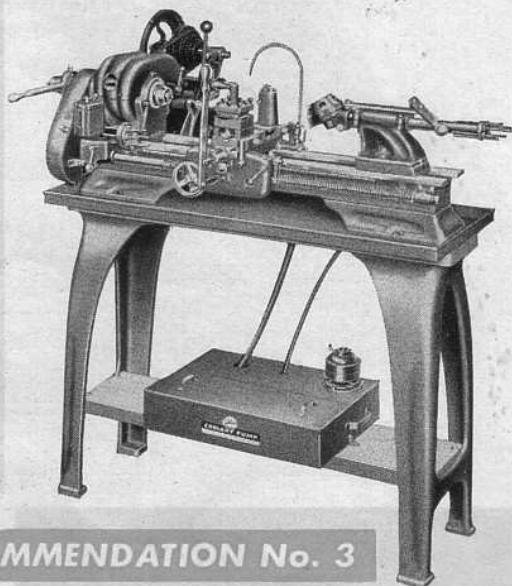

RECOMMENDATION No. 3

This turret lathe group has been selected especially to permit quick changeovers from job to job. The Atlas "Pick-O-Matic" change gears increase versatility by permitting operator to choose instantly one of several threads and feeds (pages 8-9). Universal and independent chucks hold large pieces and may be supplemented with draw-in or lever-type collet chucks for bar stock (page 14).

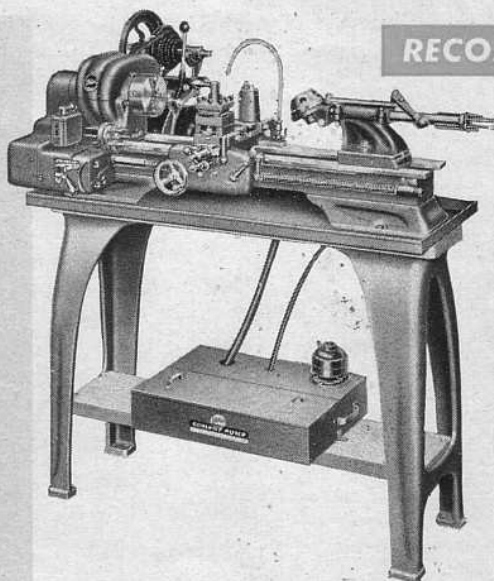

An ideal installation for the manufacture of screw machine parts requiring fast feeding across bar stock. Chucks available for turret lathe work (see page 19), also new "Pick-O-Matic" change gears for thread cutting (pages 8-9).

No.	Description	Page
TH42	Atlas F-Series 10" Lathe with horizontal countershaft, Timken tapered roller bearings for headstock spindle.....	6
1200	Pick-O-Matic Change Gears.....	8-9
10F-442B	Floor Stand.....	13
10-775A	Oil Pan.....	22
420HD	Heavy-Duty Reversing Switch.....	13
670	Plain-Type Carriage Turret.....	15
690	Multi-Stop Attachment.....	15
600	Tailstock Turret.....	15
U-770B or U-765B	6" Heavy-Duty Universal or Independent Chuck.....	19
W89	Universal Coolant Pump and Tank.....	22
W96	Coolant Feed and Return Lines.....	22

No.	Description	Page
TH42	Atlas F-Series 10" Lathe with horizontal countershaft, Timken tapered roller bearings for headstock spindle.....	6
10F-442B	Floor Stand.....	13
10-775A	Oil Pan.....	22
420HD	Heavy-Duty Reversing Switch.....	13
900B	Lever-Type Collet Chuck.....	14
751	Holding Collets (specify diameters required).....	14
548	Spindle Nose Cap.....	14
800	Lever-Type Carriage Turret.....	15
690	Multi-Stop Attachment.....	15
600	Tailstock Turret.....	15
W89	Universal Coolant Pump.....	22
W96	Coolant Feed and Return Lines.....	22
Swing over Carriage Turret Slide.....		4-3/4"
Cross Travel of Carriage Turret.....		6-1/2"
Overall with Tailstock Turret at Extreme Right.....		59" x 21" x 52-5/8" high

RECOMMENDATION No. 4

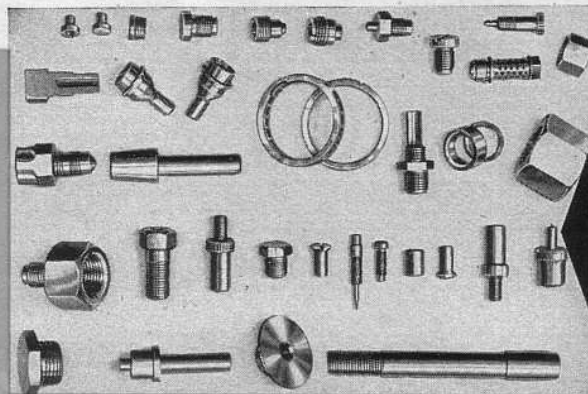
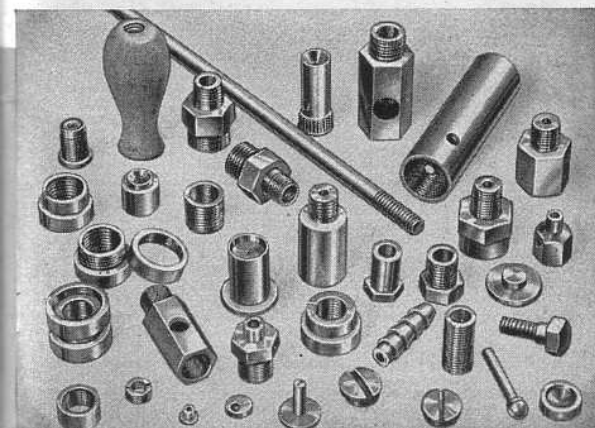

Other Atlas-lathe-produced parts. When requesting specific tooling information, please send sample parts or sketches and principal specifications.

COMPLETE SPECIFICATIONS

Atlas F-SERIES 10" LATHES

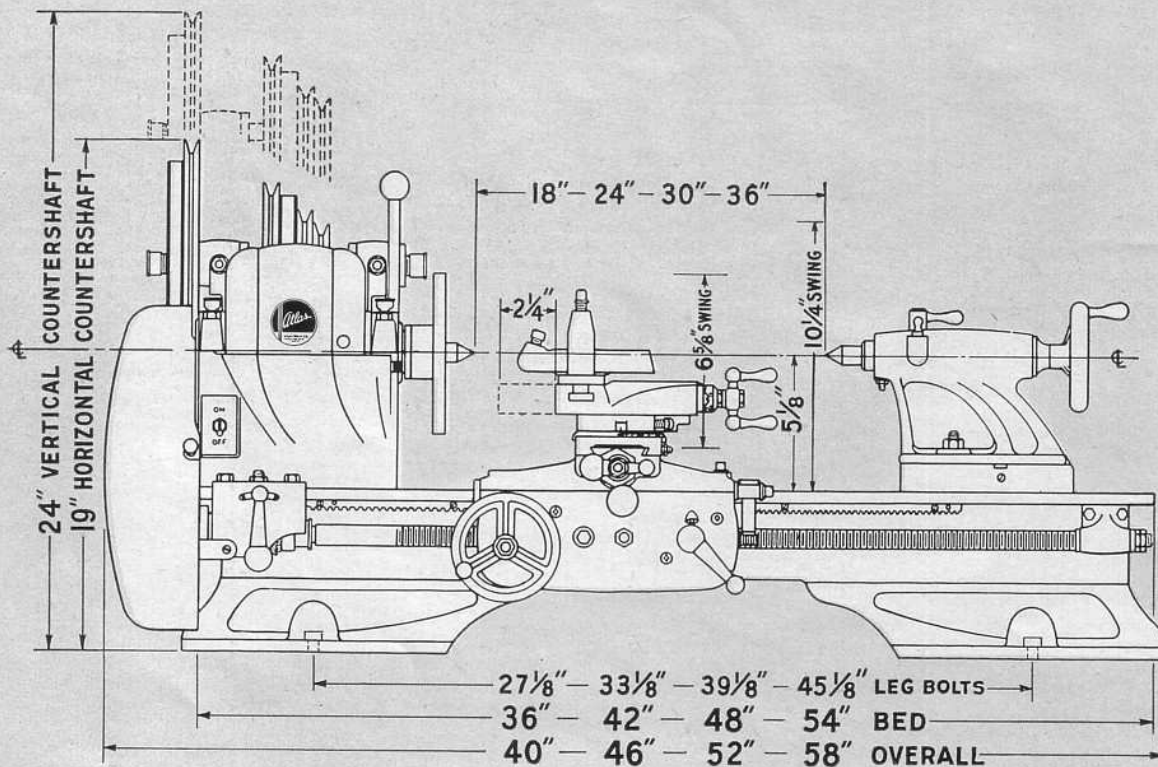

COMPLETE SPECIFICATIONS AND EQUIPMENT FURNISHED — ATLAS F-SERIES 10" LATHES

CAPACITY

Swing Over Bed.....10-1/4"
 Swing Over Carriage.....6-5/8"
 Threading Range, 4 to 96 Standard, Right or Left
 Hand — Metric, .5 to 7 mm. Standard
 Collet Capacity.....1/2" (see page 14)

SPEEDS AND FEEDS

No. of Spindle Speeds—16 (8 Direct, 8 Backgeared)
 8 Direct Spindle Speeds.....164, 266, 418, 500, 685,
 805, 1270, 2072 R.P.M.
 8 Backgeared Spindle Speeds.....28, 45, 70, 83, 112,
 134, 211, 345 R.P.M.
 Feeds (Left or Right) per Revolution of Spindle.....
 .0104", .0087", .0070", .0060",
 .0050", .0035", or .001877" (Equivalent in threads
 per inch: 96, 115, 143, 167, 200, 289 or 533
 Lead Screw.....3/4" Diam., 8 Acme Threads per inch
 Change Gears Furnished.....16

HEADSTOCK

Spindle Nose.....1-1/2" Diameter
 8 pitch National Form Threads
 Spindle Nose Taper.....Bored for No. 3 Morse Taper
 with reducing sleeve to take No. 2 Morse Taper
 Hole Through Spindle.....25/32"
 Back Gears.....12 Pitch, 7/8" Wide
 Backgear Shaft Bearings.....Oilite Bronze
 Backgear Ratio (approximate).....6 to 1
 Spindle Gear.....16 Pitch, 32 Teeth, 7/8" Wide

TAILSTOCK

Tailstock Ram.....1-1/8" Diameter
 Tailstock Ram Travel.....2-3/4"
 Tailstock Ram Graduations.....0 to 3" by 1/16ths
 Tailstock Set-Over, Forward or Back.....3/4"

CARRIAGE

Cross Feed Travel.....6-1/2"
 Cross Feed Screw.....1/2" Diameter, Acme Threads
 Feed Screw Collar Graduations.....0 to 0.1" by .001"
 Tool Post Slide Travel.....2-1/4"
 Tool Post.....3/8" x 7/8" slot to take 3/8" Tool Bits
 or Tool Holder for 1/4" Tool Bits
 Tool Post Swivel.....Graduated 0 to 90° right and left
 Motor Recommended.....1/3 or 1/2 H.P., 1725 R.P.M.
 Motor Mounting.....Adjustable Base
 Hole Through Motor Pulley.....1/2" Diameter
 Built-In Motor Control Switch.....10 Ampere
 Switch is for single phase current only
 — 3-phase switch is No. S7-300 (page 13)
 Countershaft Spindle.....Roller Bearings
 V-Belts for Complete Drive.....1/2" Wide
 Motor Pulleys.....2-step
 Drive Pulleys.....4-step

DRIVE UNIT

Reversible Automatic Power Cross Feed and Longitudinal Feed, Quick-Change Countershaft, Complete V-Belt Drive, 60-Hole Indexing Mechanism, Chrome Plated Control Handles. Finish, Gray.

EQUIPMENT FURNISHED — F-SERIES 10" LATHES

Reversible Automatic Power Cross Feed; Reversible Automatic Power Longitudinal Feed; Graduated Compound Rest; Tool Post, Ring, and Rocker; Complete Set of Change Gears to Cut Standard Threads from 4 to 96 per inch and standard metric threads from .5 to 7 mm.; Threading Chart, Threading Dial; Quick-Change Countershaft with Motor Mounting Bracket; Belts and Pulleys for Complete V-Belt Drive; Motor pulley furnished is for 1/2" diameter motor shaft — prices of pulleys for other motor shafts on request; 10-Ampere Motor Control Switch and Cord — switch is for single phase current only, 3-phase switch is No. S7-300 (page 13); 60-Hole Indexing Mechanism; 6" Face Plate; Two 60° Lathe Centers; Reducing Sleeve for Headstock Center; Combination Multi-Purpose Wrench, Wrenches for Socket-head Screws; Instruction Book — Atlas "Manual of Lathe Operation" (page 18).

- ★ PRECISION GROUND BED WAYS
- ★ EXTRA POWER FOR HEAVY JOBS
- ★ INSTANTLY REVERSIBLE AUTOMATIC POWER CROSS FEED AND LONGITUDINAL FEED

- ★ CUSTOM BUILT SPINDLE BEARINGS
- ★ COMPLETE V-BELT DRIVE — 16 SPEEDS
- ★ WIDE THREAD CUTTING RANGE
- ★ 60-HOLE INDEXING MECHANISM

MOTORS and ACCESSORIES for 10" LATHES

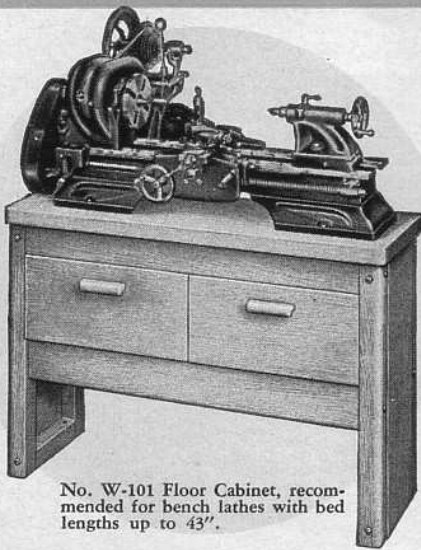

No. W-101 Floor Cabinet, recommended for bench lathes with bed lengths up to 43".

HARDWOOD MACHINE CABINETS

Atlas hardwood floor cabinets Nos. W-101 and W-102 provide rigid support for bench lathes, screw machines, etc. These cabinets are patterned after modern heavy-duty scientific laboratory furniture. Massive solid-hardwood construction with frame joints glued, screwed and bolt reinforced. Overall height 31 1/2". Table board 1 5/8" thick. Roomy drawer, 7 1/2" deep, and cupboard with pull-down drawer, 8 1/4" high. Flush-type drawers, door. Natural finish.

Order No.	For Bed Length	SPECIFICATIONS		Code Word
		Table Dimensions	Weight	
W-101	36" and 42"	45" x 14"	160 lb.	YIBCA
W-102	48" and 54"	57" x 14"	186 lb.	YIBDE

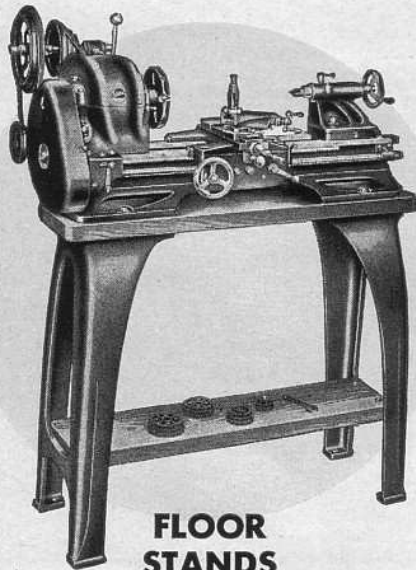

FLOOR STANDS

A rigid foundation for accurate lathe work. Legs are heavy iron castings ribbed and cross-braced for rigidity. Legs alone weigh 95 pounds. Lathe mounts with each leg directly over a floor leg, anchoring securely. Height 33 5/8". (Height 29 5/8" also available for vocational education work.) Bottom board handy for tools and accessories.

Floor Stands for 10" Lathes WITH VERTICAL COUNTERSHAFT			
No.	For Bed Length	Weight	Code
10D-442A	36"	150 lb.	YADYO
10D-442B	42"	155 lb.	YAEBS
10D-442C	48"	160 lb.	YAECT
10D-442D	54"	165 lb.	YAEGY
No. 10D-441 FLOOR LEGS ONLY. Code YADVE, wt. 110 lb.			

When ordering, please give lathe serial number or year purchased — serial number is stamped on right end of front bed way.

Floor Stands for F-Series 10" Lathes WITH HORIZONTAL COUNTERSHAFT			
No.	For Bed Length	Weight	Code
10F-442A	36"	161 lb.	YEPP0
10F-442B	42"	166 lb.	YEPY0
10F-442C	48"	171 lb.	YEPYR
10F-442D	54"	176 lb.	YERAN
No. 10F-441 FLOOR LEGS ONLY. Code YEVAR, wt. 110 lb.			

HEAVY-DUTY MOTORS

ATLAS CAPACITOR-START motors are built especially for the tough job. They have high starting and pull-out torque, developing full power instantly under load without drawing excess current. They perform the same function as repulsion-induction motors, with lower initial and operating costs.

Atlas capacitor-start motors are equipped with large SKF ball bearings — may be operated in any position: horizontal, vertical or inverted. Combination 110-220 volt 60 cycle, 10-foot approved SJ extension cord and plug furnished.

ATLAS THREE PHASE Motors are 60 cycle — with large SKF ball bearings and 1/2" single-end shaft. Furnished with BX connector in terminal box — do not have switch, cord, or plug.



ATLAS MOTORS — COMPLETE SPECIFICATIONS

Order No.	Horse Power	Voltage	RPM	Bearings	Phase, Type	Cord and Plug	Switch	Weight	Code
2520B	1/3	110-220	1725	SKF Ball	Single Phase Capacitor Start	Yes	No	33 lb.	ZEWOR
2530A	1/2	110-220	1725	SKF Ball	Single Phase Capacitor Start	Yes	No	40 lb.	WYZIC
2620	1/2	220	1725	SKF Ball	Three	No	No	35 lb.	ZEWRO
2630	1/3	220	1725	SKF Ball	Three	No	No	28 lb.	ZEWPE
2625	1/2	440	1725	SKF Ball	Three	No	No	35 lb.	ZEWUS
2635	1/3	440	1725	SKF Ball	Three	No	No	30 lb.	ZEWYT

ALL MOTORS LISTED ARE 60 CYCLE — ALL HAVE 1/2" SINGLE-END SHAFT

REVERSING SWITCHES



THE No. 420HD is a heavy duty 1 HP drum-type reversing switch for voltages up to 600 AC. Has large diameter arc shields, snappy star wheel indexing, forged copper-tipped fingers. Operates on single phase, capacitor, and 3-lead repulsion-induction motors (not 4-lead) — also both shunt-wound and compound-wound DC. Mounts on reverse gear box, a handy, easy-to-reach position.

No. 420HD HEAVY-DUTY REVERSING SWITCH complete with mounting bracket, 6 ft. heavy cord and plug, installation diagram. Code YICAD, wt. 3 1/2 lb.

THE No. 10-420 Reversing Switch (right) is a drum-type switch with knobbed lever control easily shifted to forward, off, or reverse position. Durable contacts are hard rolled copper. Operates on single phase, capacitor, and 3-lead repulsion-induction motors (not 4-lead) — also both shunt-wound and compound-wound DC. Mounts on reverse gear box.

No. 10-420 REVERSING SWITCH complete with mounting bracket, cable connections, installation diagram. YELJE, 3 1/2 lb.

No. 420D THREE PHASE REVERSING SWITCH complete with mounting bracket cable connections, installation diagram (a heavy-duty 1 HP drum-type switch for voltages up to 440 AC). Code YEMYP, wt. 4 lb.



THREE PHASE MOTOR CONTROL SWITCH

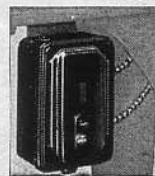

Required with a three phase motor. A thermal overload 3-pole manual starter for 3-phase circuits. Bracket for bench mounting, flexible cable-covered motor connection cord furnished.

No. 57-300 THREE PHASE CONTROL SWITCH with bench mounting bracket, connections. Code ZEBAR, weight 6 lb.

COLLET CHUCK ATTACHMENTS FOR 10" LATHES

LEVER-TYPE Collet Chuck Attachment

Chucks and Releases Work with Lathe Running

This lever-release collet attachment is the ideal chucking method for fast, accurate duplicate work on bar stock between 1/32" and 1/2" diameter. Teamed with turret attachments (page 15), it converts the Atlas ten-inch lathe into a high-speed hand-type production screw machine.

Work may be fed through the hollow torque tube of the lever-type attachment, chucked, machined and released *without stopping the lathe*. Moving hand lever to the left tightens collet on work — collet is released by moving lever to right. Adjustment of collet tension is made with knurled collar at left end of torque tube. Tapered collet sleeve is ground inside and outside to insure concentric closing of collet. Spindle nose cap protects lathe spindle threads.

The No. 900B attachment is easy to install — there are no holes to drill or tap.

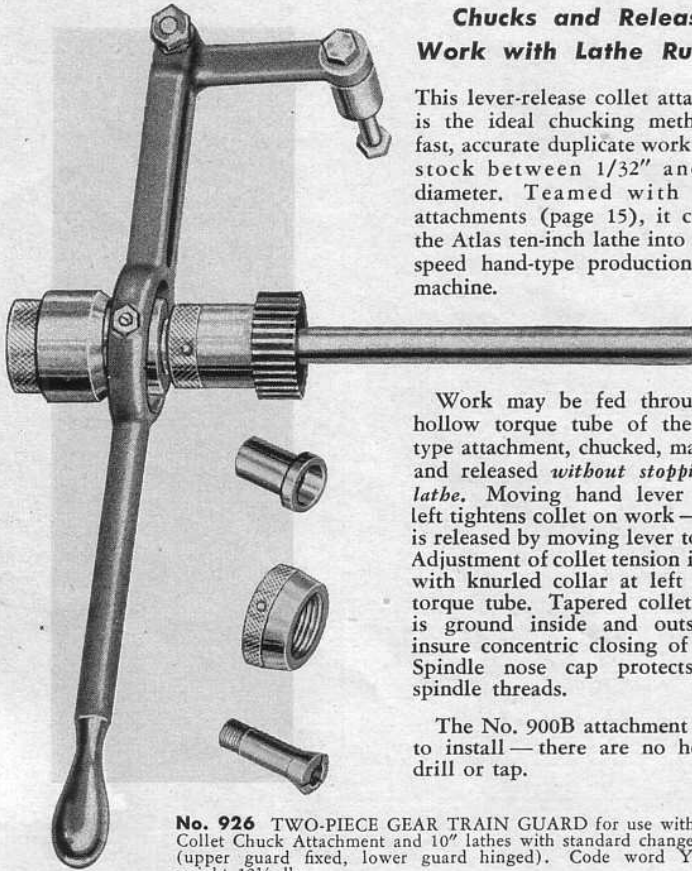

No. 926 TWO-PIECE GEAR TRAIN GUARD for use with 900B Collet Chuck Attachment and 10" lathes with standard change gears (upper guard fixed, lower guard hinged). Code word YICU, weight 12½ lbs.

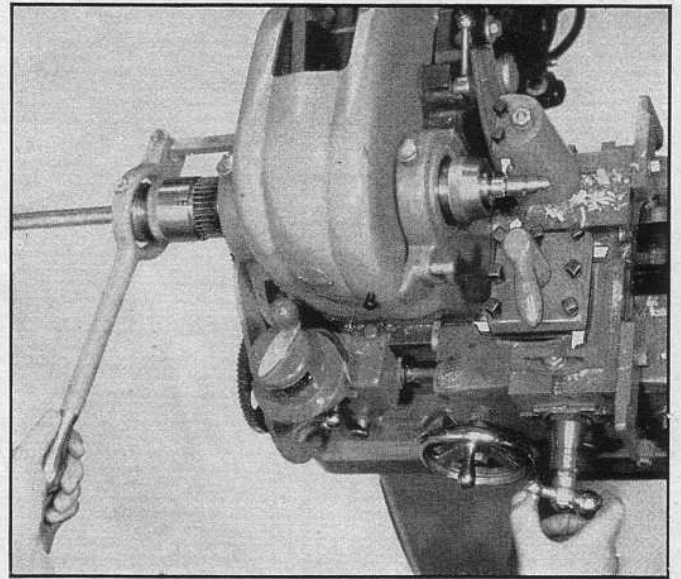

No. 900B Lever-Type Collet Chuck Attachment handling production work with turret attachments.

No. 900B LEVER-TYPE COLLET CHUCK ATTACHMENT for Atlas F-series 10" Lathes. Furnished complete as shown with one split holding collet listed below — specify diameter. Code word YIBAC, weight 6 lb.

FURNISHED COMPLETE

The 900B Lever-Type Collet Chuck Attachment is furnished complete with hollow torque tube, hand lever control, tapered closing sleeve, spindle nose cap, support bracket, mounting instructions, and one split holding collet listed below — *specify diameter desired*.

DRAW-IN COLLET CHUCK ATTACHMENT



The draw-in collet chuck attachment is the most accurate method for chucking work between 1/32" and 1/2" in diameter. It is used in making precision tools, instruments, gauges, and in the production of small parts when extreme accuracy is demanded. The complete attachment consists of a hollow draw-in spindle with handwheel control, tapered closing sleeve, and split holding collet.

The hollow draw-in spindle extends through the lathe headstock spindle and is threaded at the spindle nose end to hold the collets in the tapered sleeve. The hollow construction permits rods to be passed through the lathe spindle — the handwheel releases and tightens the collet on work. Tapered sleeve is ground inside and outside to insure extreme accuracy. Lathe must be stopped to open and close collet.

No. 750 DRAW-IN COLLET CHUCK ATTACHMENT complete. Includes draw-in spindle, tapered closing sleeve, and one split holding collet listed below — specify diameter. Code word YAIRL, weight 3 lb.

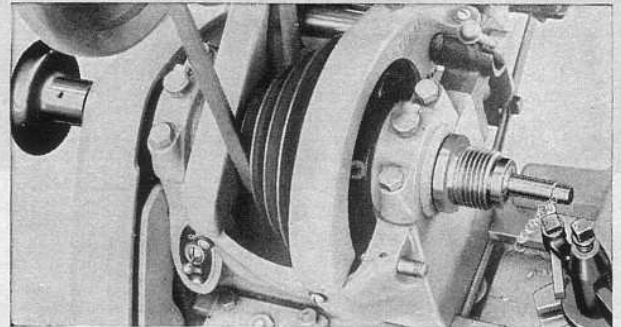

No. 750 Draw-In Collet Chuck Attachment in Operation.

No. 751 SPLIT HOLDING COLLET for round work — specify diameter. Available in 32nds between 1/32" and 1/2" as follows: 1/32", 1/16", 3/32", 1/8", 5/32", 3/16", 7/32", 1/4", 9/32", 5/16", 11/32", 3/8", 13/32", 7/16, 15/32" and 1/2". Code word YAJAZ, weight 4 ounces each.

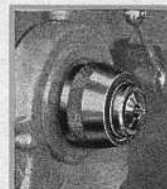
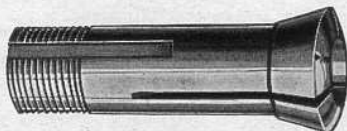

SPINDLE NOSE CAP

No. 548 SPINDLE NOSE CAP protects lathe spindle threads. Code word YETRE, weight 12 ounces.

SPLIT HOLDING COLLETS

Collet tool steel, heat treated and ground inside and outside for precision work. One end of the collet is threaded to fit the draw-in spindle or torque tube and the other end is ground to fit the tapered closing sleeve. Keyway prevents collet turning while in operation. These collets handle round work with diameters between 1/32" and 1/2" by 32nds (left). One collet, any fractional size as listed at left, is furnished with the No. 750 or No. 900B collet chuck attachment. Collets available for hexagonal, square, special work; details on request.

TURRET ATTACHMENTS

FOR PRODUCTION WORK
ON 10" LATHES

LEVER-TYPE CARRIAGE TURRET

The carriage turret converts the Atlas ten-inch lathe into an efficient turret lathe-screw machine for the manufacture of small parts on a production basis. Pages 10 and 11 show assortments of typical parts being produced quickly and economically with this equipment. Work range includes such operations as forming, roughing, finishing, chamfering, cutting off.

The No. 800 lever-type carriage turret (right) consists of a feed lever for fast cross feeding of carriage, four-way tool post turret, back-slide tool post, and double tool cross slide. Lathe must be equipped with the double tool cross slide, which replaces the standard compound rest assembly and adapts the turret to the carriage cross slide dovetails.

The feed lever, simply installed in place of the standard screw feed, cuts operating costs by speeding up all cross-carriage turret action. High leverage ratio permits sensitive feeding. Feed lever may be purchased separately and installed on Atlas plain-type carriage turrets (No. 710, right).

The four-way tool post turret head may be released by the convenient lock handle and rotated quickly to any one of four operating positions, automatically indexed. The back-slide tool post permits a fifth operation, usually cutting off. Power feed of Atlas lathes speeds up all longitudinal cutting operations. Tool posts take $\frac{3}{8}$ " cutter bits. Adjustable stops at front and back of double tool cross slide may be set to indicate correct depths of cut. No. 690 "Multi-stop" (below) is recommended for quickly gauging length of cut.

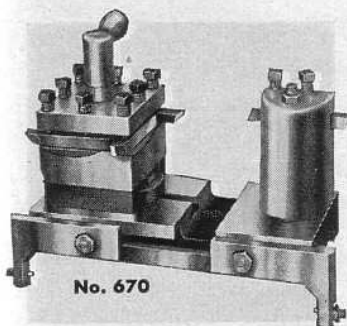

PLAIN-TYPE CARRIAGE TURRET

No. 670 plain-type carriage turret (left) consists of the double tool cross slide, four-way tool post turret, and back-slide tool post. The lathe must be equipped with the double tool cross slide, which adapts turret to carriage cross slide dovetails. Turret heads position each tool instantly. Adjustable stops gauge depth of cuts. Power cross and longitudinal feeds of Atlas lathe may be used to speed up all operations with the plain-type carriage turret. Detailed descriptions above.

RECOMMENDATIONS FOR
TURRET LATHE-
SCREW MACHINE WORK
See Pages 10-11

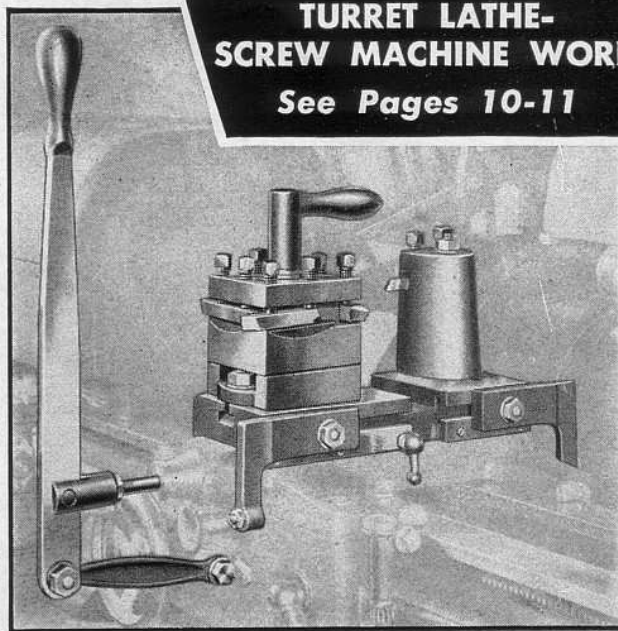

No. 800 LEVER-TYPE CARRIAGE TURRET complete as shown above—Feed lever, double-tool cross slide, 4-way turret, and back slide tool post. Code YIBIF, wt. 28 lb.

No. 710 FEED LEVER ONLY for Carriage Turret, with connections. Code word YIBJY, weight 8 lb.

No. 670 PLAIN-TYPE CARRIAGE TURRET, complete as shown at left—double tool cross slide; 4-way turret, and back slide tool post. Code YAJOD, wt. 22 lb.

No. 671A DOUBLE TOOL CROSS SLIDE only. Code word YAJUF, weight 10 lb.

No. 673A FOUR-WAY TURRET only. Code word YAJYG, weight 9 pounds.

No. 676A BACK SLIDE TOOL POST only. Code word YAJZA, weight 5 pounds.
Cutter Bits Not Furnished.

No. 385S SET OF 6 UNGROUND $\frac{3}{8}$ " CUTTER BITS. Code word YARPY, weight 1 lb.

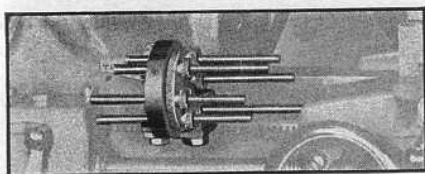

The "MULTI-STOP"

Six adjustable stop screws accurately gauge length of each cut. Each position stamped to identify operation. Position set by hand-operated ball-and-spring indexing mechanism. Mounts on front bed way near headstock.

No. 690 MULTI-STOP ATTACHMENT with mounting bracket. Code word YEHFE, weight 3 pounds.

LEVER-TYPE TAILSTOCK

Speeds up any single production operation from the tailstock—drilling, reaming, tapping, countersinking, setting length of stock, etc. Feed lever advances ram to work in an instant. Stop collar may be adjusted to gauge depth of cut.

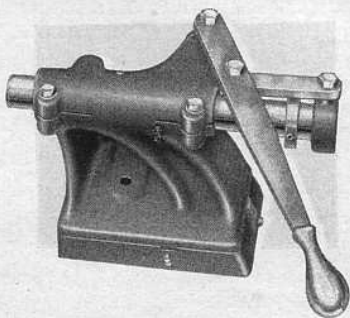

SPECIFICATIONS
Travel of Ram..... $\frac{35}{8}$ "
Ram Diameter..... $\frac{1}{8}$ "
Ram.....Bored for No. 2 Morse taper
Ram Graduations...0 to 3" by $\frac{1}{16}$ ths
Setover, Forward or Back..... $\frac{3}{4}$ "

No. 695 LEVER-TYPE TAILSTOCK as shown. Code word YIBGO, wt. 29 lb.

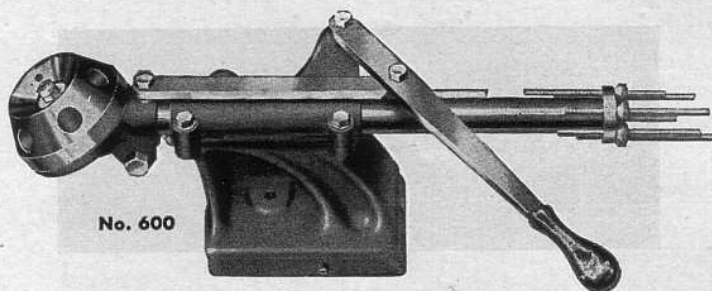

TAILSTOCK TURRET

The tailstock turret includes the indexing head and an extra long feed ram with hand-lever control and depth stop screws mounted in a special turret tailstock. The semi-automatic indexing head has six $\frac{3}{4}$ " bored holes for tool holders, each permitting a separate operation. Moving quick-acting hand-feed lever to extreme right unlocks turret head so next tool may be positioned; advancing feed lever locks head in position. Six adjustable stop screws at end of feed ram are automatically indexed with head, and accurately gauge depth of each operation. To assure accurate spindle and tool alignment, holes for tool holders should be bored by lathe on which turret is to be operated. Turret travel, 3-7/16".

No. 600 TAILSTOCK TURRET with head finish bored. Complete with special tailstock, lever feed, stops. Code word YAJIC, weight 39 pounds.

No. 600A TAILSTOCK TURRET with head unbored. Complete with special tailstock, lever feed, and stops. Code word YAJEB, weight 39 pounds.

The Atlas Engineering Department is prepared to recommend proper tools and attachments for industrial turret and screw machine jobs. When requesting information, please send sample parts, or sketches and principal specifications.

MILLING ATTACHMENT FOR 10" LATHES

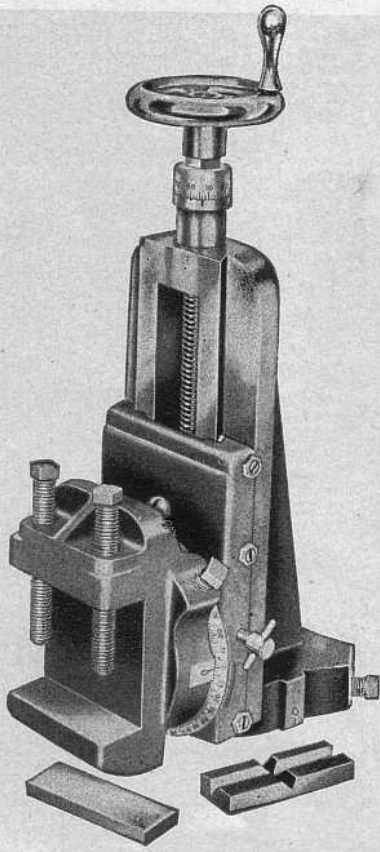

THIS attachment equips the Atlas 10-inch lathe for face milling, cutting keyways and slots, milling dovetails, squaring shafts, making dies and moulds and a wide variety of other important operations. The change is made quickly and easily by removing the compound rest and clamping the base of the milling attachment in its place.

The milling attachment can be swivelled completely to hold work at any angle. Extra heavy castings reduce vibration — gib take-up assures permanent accuracy. The position of the vise is controlled by a feed screw with micrometer graduated collar. Two positive clamping screws lock the vise to hold the work firmly in position. Vise slide is graduated, and vise can be swivelled to any desired angle. For handling extra large work, clamping plate may be fastened in place of the vise (see above, right).

No. 500A MILLING ATTACHMENT for Atlas 10-inch lathes. Code word YAKBA, weight 19 lb.....

Vertical Feed..... $3\frac{3}{4}$ " Vise Capacity..... $2\frac{3}{8}$ "
 Cross Feed.....5" Jaw Depth..... $\frac{7}{8}$ "
 Overall Height13" Jaw Width..... $2\frac{1}{2}$ "

FURNISHED: Complete as shown including graduated swivel vise, vertical feed screw with graduated collar, flat block, V-block for round work.

CLAMPING PLATE For Extra Large Work.

Clamps in place of vise — capacity $2\frac{3}{4}$ " diameter. Grey iron casting with machined working surfaces and T-slot for bolt. Drop-forged clamp, bolt furnished.

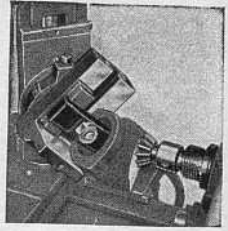

(Above) Handling Milling operation on large piece. (Left) Handling boring operation with work held in clamping plate, boring bar mounted between centers. Blueprint for making boring bar — No. BP-101. Code word YEREP.....

No. 502B Clamping Plate Code YEZOZ, wt. 5 lb. **IMPORTANT!** Give lathe serial no. and date purchased.

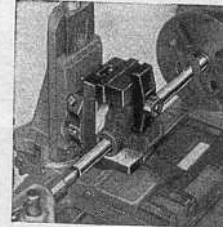

GEAR CUTTING

A blueprint is available for building the gear cutting attachment shown at right. Mounted in the milling vise, it holds blank gear at one end and indexing gear at the other. Outer shank of index shaft can be adapted to hold any indexing gear.

No. BP-102 BLUEPRINT of Gear Cutting Attachment. Code YERNA.....

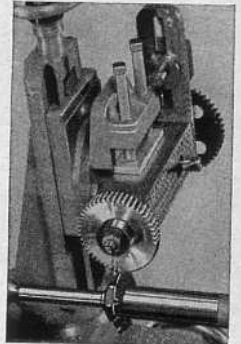

This set holds the milling cutter in headstock spindle. Consists of draw bar, sleeve, and one arbor for $\frac{1}{2}$ " straight shank cutters.



CUTTER HOLDING SET

No. 945 CUTTER HOLDING SET. Complete: draw bar, sleeve and arbor. Code YEYAT, wt. 3 lb.

ANGULAR CUTTERS WITH THREADED HOLE

For face-milling, dovetailing, and cutting angles less than 90° . Included angle is 60° . Adapted to holding set with arbors listed below. Weight 6 oz. each.

No.	Thick	Diameter	Hole	Thread	Code
574A	$\frac{7}{16}$ "	$1\frac{1}{4}$ "	$\frac{3}{8}$ "	24	YALIF
574B	$\frac{9}{16}$ "	$1\frac{1}{8}$ "	$\frac{1}{2}$ "	20	YALJY

ARBORS FOR ANGULAR CUTTERS

Required to adapt 574 angular cutters to No. 945 holding set. Weight 8 oz. each.

No.	For No.	Code
572	574A	YEWTE
567	574B	YEWUX



R. H. SPIRAL STRAIGHT SHANK END MILLS

For general milling operations — slots, facing and routing, squaring and splining shafts, cutting straight keyways. Adapted to holding set with collet bushings below. 4 oz. each.

No.	Length of Flute	Diameter	Code Word
576A	$\frac{5}{8}$ "	$\frac{1}{4}$ "	YAKCE
576B	$\frac{11}{16}$ "	$\frac{5}{16}$ "	YAKEC
576C	$\frac{3}{4}$ "	$\frac{3}{8}$ "	YAKFO
576D	$\frac{7}{8}$ "	$\frac{7}{16}$ "	YAKID
576E	$\frac{15}{16}$ "	$\frac{1}{2}$ "	YAKOF



COLLET BUSHINGS

Required to adapt 576 straight shank end mills to No. 945 holding set. Not required for 576E end mill.

No. 563E FOUR COLLET BUSHINGS. Code YALED, weight 6 oz.....

STRAIGHT SHANK WOODRUFF KEYWAY CUTTERS

Designed especially for cutting Woodruff keyways — also used for milling slots, grooves, T-slots, etc. Held directly in arbor of No. 945 holding set. Weight 6 oz. each.

No.	Diameter	Thickness	Diam. Shank	Code
575A	$\frac{1}{2}$ "	$\frac{1}{8}$ "	$\frac{1}{2}$ "	YALUH
575B	$\frac{3}{4}$ "	$\frac{3}{16}$ "	$\frac{1}{2}$ "	YALYJ
575C	1"	$\frac{1}{4}$ "	$\frac{1}{2}$ "	YAMAD
575D	$1\frac{1}{8}$ "	$\frac{5}{16}$ "	$\frac{1}{2}$ "	YAMDA
575E	$1\frac{1}{4}$ "	$\frac{3}{8}$ "	$\frac{1}{2}$ "	YAMEF



10" LATHE ACCESSORIES

BORING TABLE and VISE

This fixture permits boring and threading long holes with maximum accuracy — holds work rigidly while cut is taken with boring bar. It replaces the lathe compound rest. The table working surface is machine ground. Two socket-head cap-screws lock table to lathe cross slide. Four T-slots for positioning and locking vise jaws extend from center of table to edges. Each vise jaw is locked by a socket-head cap-screw. One jaw can be swiveled to grip irregular work — the other has a movable face which is tightened on the work after both jaws have been clamped to the table.

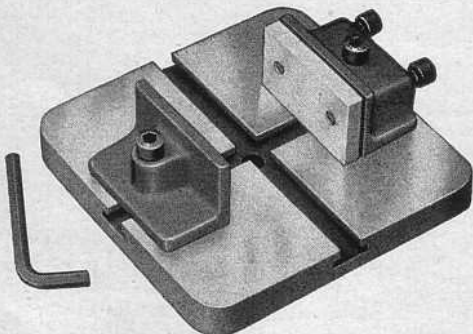

No. W68-2A BORING TABLE for 10" lathes, complete with vise and wrench. Code word ZEFZO, wt. 12 lb.....

Size of Table..... 7 " x 7 " Jaw Opening..... $\frac{45}{8}$ "
 Jaw Width..... 3 " Jaw Height..... $1\frac{1}{8}$ "

No. W8V V-Block Jaw for holding round work in vise jaws. Code word ZADSO, weight 10 oz.....

No. BP-101 Blueprint Guide for making Boring Bar shown at right. Code word YEREP.....

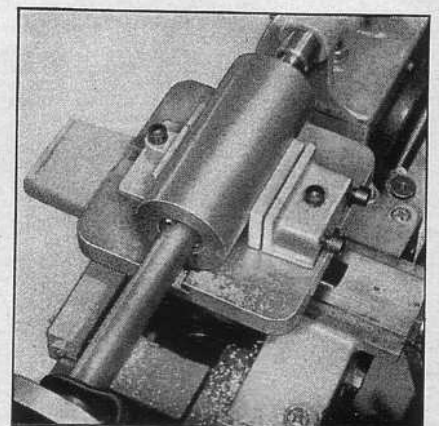

HEAVY-DUTY GRINDER FOR 10" LATHES

No. 10-450

THE 10-450 is a lathe grinder with extra weight, strength and power for large heavy jobs plus the accuracy and all-round efficiency required to handle the finest internal and external grinding operations on a production basis.

The main frame is a heavy casting which furnishes maximum strength and rigidity. Spindle housing is accurately machined to take bearings. One end of the frame supports the motor mounted on tilting bracket adjustable for belt tension. Frame is bored for mounting post. Post is 1-3/16" diameter and has support plate and device for clamping in tool post slot of lathe compound rest. Coordinate-type clamp locks grinder securely in any vertical or radial position on mounting post. Vertical position is adjusted by raising screw with knob control.

Two lubricated-and-sealed-for-life ball bearings, properly preloaded, carry the grinder spindle. These bearings are spaced 3 1/8" apart, and the front bearing is 3/4" from the grinding wheel — this design maintains permanent spindle rigidity. The heavy-duty spindle is 5/8" diameter, accurately ground and fitted to the bearings. Spindle takes 4" external wheel and has socket machined to take taper and screw of quill for holding internal grinding wheels. External wheel is enclosed by iron guard, easily removed for mounting internal quill. Diamond dresser for keeping wheels true and sharp is furnished.

The 10-450 grinder is powered by a 1/4 HP 3450 RPM ball bearing motor. This fine motor furnishes a smooth, even flow of power and maintains constant spindle speed. Operates on 110 volt 60 cycle AC current. Two-step balanced pulleys provide grinding spindle speeds of 4900 and 9100 RPM at full load. Belt is completely covered by safety shield.



View of 10-450 heavy-duty grinder with belt guard removed, showing two-step pulleys, built-in switch, and belt-tensioning screws.

SPECIFICATIONS — No. 10-450 HEAVY-DUTY 10" LATHE GRINDER

Maximum Distance from Center of Wheel to Center of Work (with Grinder Perpendicular to Work).....	4 1/8"
Grinds External Diameters up to.....	4 1/4"
Grinds Internal Diameters from.....	1/4" to 9 1/4"
Internal Wheels Grind to Depth of.....	2 3/8"
Base Swivels for Angular Grinding.....	0 to 90°
Spindle.....	5/8" Diameter, Lubricated-and-Sealed-for-Life Ball Bearings
Height above Bed when Mounted for Operation.....	15"
Motor.....	1/4 HP 3450 RPM Single Phase, 110 Volt, 60 Cycle AC, Single-End Ball Bearing Shaft, Built-in Switch
Spindle Speeds.....	4900 and 9100 RPM, Full Load

GRINDING WHEELS

Medium Grit. No. 10-475 external wheel and No. 477 1/2 internal wheel are furnished as standard equipment with the 10-450 lathe grinder.

No.	Description	Diam.	Weight	Code
10-475	External Wheel for Steel, 3/8" thick.....	4"	1 lb.	YENKA
10-476	External Wheel for Cast Iron, 3/8" thick.....	4"	1 lb.	YENLE
477 1/4	Internal Wheel	1 1/4"	2 oz.	YANJO
477 1/2	Internal Wheel	1 1/2"	3 oz.	YANLY
477 3/4	Internal Wheel	1 3/4"	3 oz.	YANOJ
477-1	Internal Wheel	1"	3 oz.	YANUK
10-478	Special Cup Wheel for O.D. of Reamers.....	2 3/4"	8 oz.	YEVIT
479	Special Saucer Wheel for Face of Solid Reamers.....	3/4"	3 oz.	YAODY

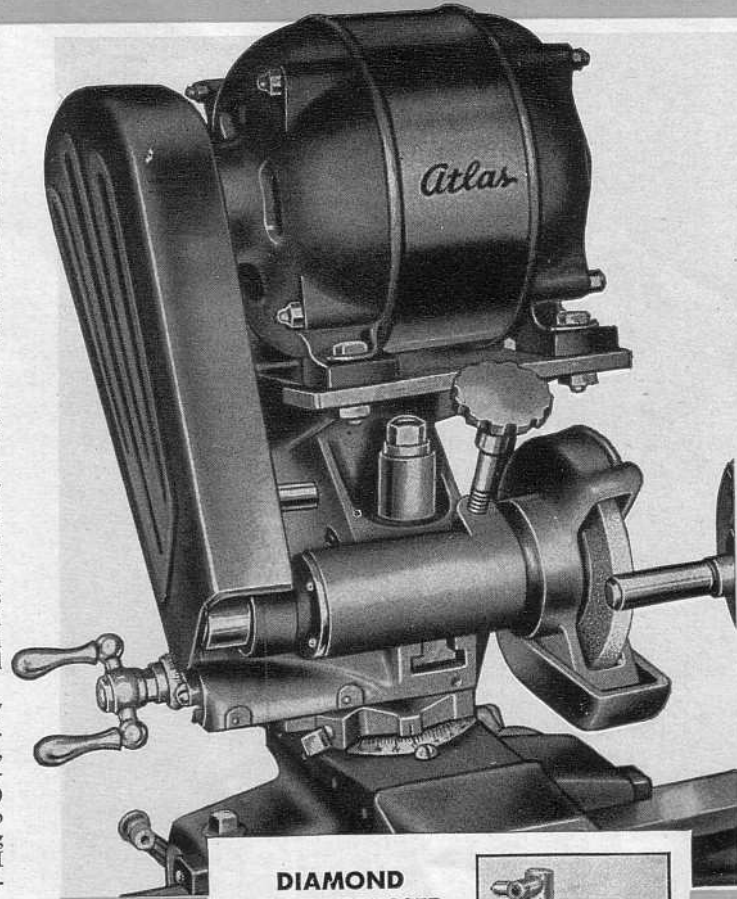

DIAMOND WHEEL DRESSER

Furnished with No. 10-450 lathe grinder. Clamps to bed ways and dresses wheel in exactly the position in which it will be used. Illustration also shows internal grinding quill and No. 477 1/2 wheel furnished with No. 10-450 grinder.



★
REVERSING SWITCH BELOW

No. 10-450 HEAVY-DUTY GRINDER for Atlas 10" lathes. Code word YENEL, weight 60 lb.

EQUIPPED with belt and No. 10-475 external grinding wheel mounted on spindle, quill for internal work, No. 477 1/2 internal grinding wheel, diamond wheel dresser. Motor has switch, cord and plug.

ATTACHMENTS FOR No. 10-450 LATHE GRINDER

REAMER-GRINDING ATTACHMENT

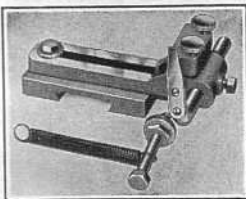

Required for sharpening spiral, tapered or straight reamers and side teeth of spiral or straight end mills. Includes a holding fixture, index finger guide, and spring tension clamp.

No. 535 REAMER GRINDING ATTACHMENT for No. 10-450 grinder. Code word YAOLG, weight 4 lb.....

VALVE STEM and CUTTER GRINDING ATTACHMENT

Required for grinding valve stems, tappet screws, and valve reseating cutters. Consists of V-block for valve stems, cutter clearance gauge, index finger, and cutter arbor with centering pin for grinding reseating cutters.

No. 550 VALVE STEM AND CUTTER GRINDING ATTACHMENT for No. 10-450 grinder. YAONJ, 3 lb.



HEAVY-DUTY REVERSING SWITCH

Required for Grinding Operations

No. 420HD heavy-duty switch quickly changes the rotation of the lathe spindle by reversing the motor. It is a 1 HP drum-type switch for voltages up to 600 AC. Has large arc shields, star wheel indexing, forged copper-tipped finders. Operates on single phase, capacitor, and 3-lead repulsion-induction motors (not 4-lead) — also both shunt-wound and compound-wound DC.

Furnished with bracket for mounting on reverse gear box, a handy, easy-to-reach position. For other switches, refer to page 13.

No. 420HD HEAVY-DUTY REVERSING SWITCH complete with mounting bracket, 6 ft. heavy cord, plug, installation diagram. Code YICAD, wt. 3 1/2 lb.....



TAPER ATTACHMENTS FOR 10" LATHES

No. 700 TOOL ROOM TAPER ATTACHMENT

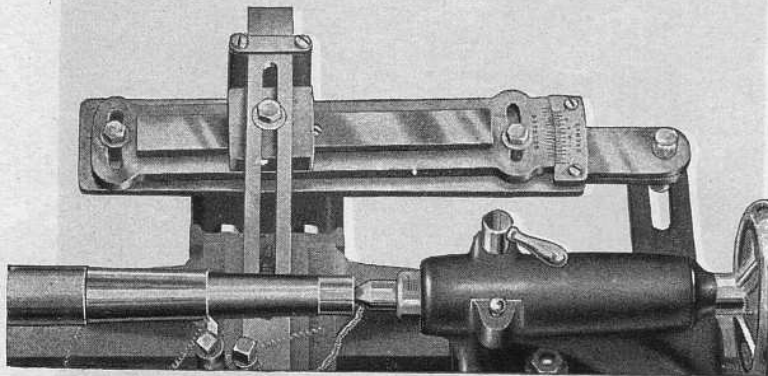

The Atlas No. 700 taper attachment is designed and recommended for tool rooms and production shops. It has the extra weight and rigidity required for extreme accuracy in production taper work. The dovetail slide bar, installed parallel to the bed way, is accurately machined and has gib adjustment to maintain accuracy. Two sets of graduations show taper both sides of center line, one in degrees and one in inches per foot. Tool is fed by slotted draw bar attached to carriage cross slide. Sturdy clamp arm assures rigid mounting.

No. 700 TOOL ROOM TAPER ATTACHMENT for Atlas 10-inch Lathes. Code word YAJDO, weight 15 pounds.
 Maximum Travel, One Setting.....6½"
 Range, Right or Left.....7° 10' (3" per foot)

No. 760 TAPER ATTACHMENT

(Right) The No. 760 is an accurate, reasonably priced taper attachment developed by Atlas engineers to meet the demand of hundreds of shops. Its sensationally low price puts this important accessory within the reach of any lathe owner. The No. 760 Atlas taper attachment is quickly installed, simple to operate, and makes accurate taper work a fast, easy job. The rectangular slide bar has two rigid grey-iron support brackets. A slotted draw bar connects to the carriage cross slide and feeds tool at desired taper. Easy-to-read index plate is graduated 7° and 3" both sides of center line.

No. 760 TAPER ATTACHMENT for Atlas 10-inch Lathes. Code word YAJBE, weight 11 pounds.....
 Maximum Travel, One Setting.....6"
 Range, Right or Left.....7° (2-15/16" per foot)

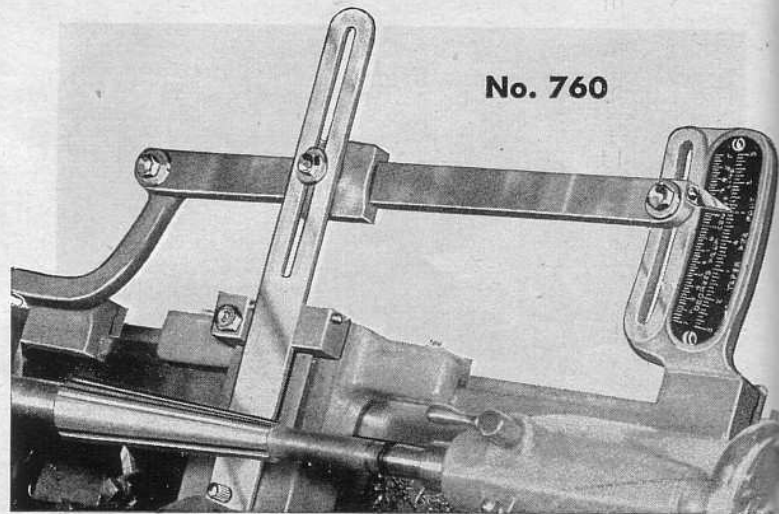

No. 760

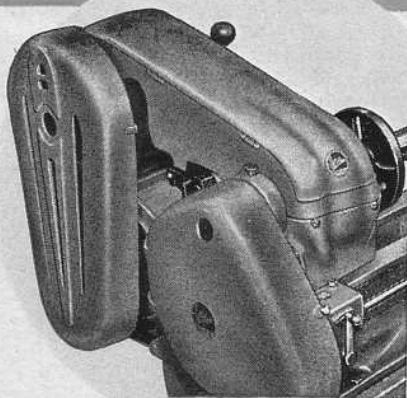

SAFETY BELT GUARDS

Atlas belt guards eliminate the hazards of exposed belting by providing a safety cover for all lathe belts as required by industrial and vocational safety codes in many states. These sturdy attractive shields may be installed on any Atlas 10-inch lathe.

Both guards are light, durable castings with pin hinges for quick raising and speed changes. It is not necessary to remove guards to change belts. The left guard

covers the motor-to-countershaft belt and has a special inner guard for the pulley on the countershaft. The right guard covers belt from countershaft to lathe spindle. The entire assembly is ready-tapped for easy installation.

The complete transmission—pulleys, feed gears, countershaft and belting — of the Atlas lathe is fully enclosed after these safety belt guards are installed.

No. 10F-720 SAFETY BELT GUARDS for Atlas 10" lathes with horizontal countershaft. Code YEYSE, weight 22 lb. Per set.....

No. 10-720 SAFETY BELT GUARDS for Atlas 10" lathes with vertical countershaft. Code YADUZ, weight 16 lb. Per set.....

"MANUAL OF LATHE OPERATION"



Opens Easily
Lies Flat

"LATHE OPERATION" has earned a place as an authentic reference source for all shop men, both experienced and beginners. Its pages illustrate and describe in easy-to-understand language the care and operation of modern screw-cutting lathes. It includes the latest technical data for machining the new metal alloys and plastics—tool grinding, cutting speeds, lubricants, tables and charts.

The Atlas Manual is logically arranged and accurately indexed for quick reference. Divisional tabs make each chapter instantly available—the special binding allows the book to lie open flat at any page.

"MANUAL OF LATHE OPERATION," 6"x9";
 272 pages; 366 pictures; 89 charts and tables.
 Postpaid per copy.....
 (Furnished free with Atlas 10" lathes)

CHUCKS FOR 10" LATHES

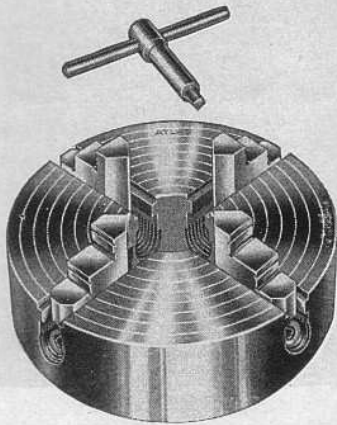

MEDIUM DUTY INDEPENDENT CHUCKS

Atlas medium duty lathe chucks are designed to handle the chucking requirements of the average shop. High strength semi-steel bodies are scientifically proportioned and exceptionally strong. Alloy steel jaws are heat treated — have raised and ground steps. Accuracy is guaranteed within standard chuck tolerances.

Rugged and accurately built for holding work of all shapes. One-piece body is high strength semi-steel casting — entire face and outer edge are ground. Hand fitted jaws are heat-treated alloy steel — deep shoulders have raised and ground steps for full, firm inside or outside grip. Jaws are reversible for large diameters. Screws are heat-treated alloy steel — have socket head for wrench. Chuck bodies are threaded for 10" lathe spindle — no adapter required.

- No. U-370** 6" MEDIUM DUTY INDEPENDENT CHUCK complete with wrench. Body threaded for 10" lathe spindle. Code word YIAGH, weight 10 lb.
- No. U-370-8** 8" MEDIUM DUTY INDEPENDENT CHUCK complete with wrench. Body threaded for 10" lathe spindle. Code word YIAHJ, weight 13½ lb.

MEDIUM DUTY UNIVERSAL CHUCK

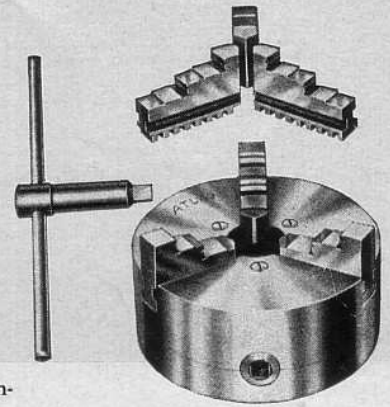

Has self-centering jaws controlled by turning one screw — ideal for quickly centering round and hexagon stock. Body is high-strength semi-steel. Scroll is special alloy metal — pinion is special alloy steel. Jaws are alloy steel heat-treated — have raised and ground steps. Furnished with two sets of jaws (inside and outside) and wrench. This chuck handles rods through headstock. Body is threaded for Atlas 10" lathe spindle — no adapter required.

- No. U-435** 5" MEDIUM DUTY UNIVERSAL CHUCK complete with 2 sets of jaws (inside and outside) and wrench. Body threaded for 10" lathe spindle. Code word YEZZO, weight 8 lb.

HEAVY DUTY INDEPENDENT CHUCK

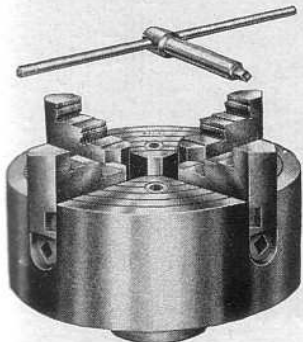

These chucks have the same general design and construction as the medium duty chucks — with the extra weight and strength required for heavy-duty jobs and production work.

Heavy, rugged one-piece high-strength semi-steel body is reinforced and braced. Jaws are special alloy machinery steel, heat treated to withstand shock, strain, and wear. Jaws are hand-fitted to body and are reversible for large diameter work. Screws are heat treated alloy steel, carefully fitted to bearings and operate the jaws smoothly. Screws have mortised heads to take square-end wrench. Thrust bearings are heat treated steel tightly fitted to body.

- No. U-765B** 6" HEAVY DUTY INDEPENDENT CHUCK complete with adapter fitted for 10" lathe spindle. Code YEZVA, wt. 13 lb.
- No. U-765** 6" HEAVY DUTY INDEPENDENT CHUCK only less adapter. Code YIAMN, weight 9½ lb.
- No. U-765A** ADAPTER PLATE for 6" heavy duty independent chuck, threaded for 10" lathe spindle, face semi-finished. Code word YIANP, weight 3½ lb.

HEAVY DUTY UNIVERSAL CHUCK

Accurate self-centering jaws are controlled by bevel gear-driven scroll. Scroll is special alloy metal. A spiral thread, with which the jaw teeth mesh, is cut on the upper side of the scroll. On the under side is the bevel gearing which meshes with the operating pinions. Pinions are special alloy steel. Hand-fitted jaws are special alloy machinery steel, heat treated to withstand shock, strain and wear. Two sets of jaws are furnished (inside and outside). Heavy rugged body is high-strength semi-steel, reinforced and braced.

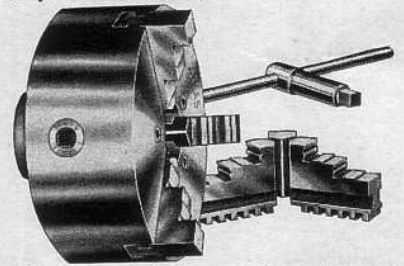

- No. U-770B** 6" HEAVY DUTY UNIVERSAL CHUCK complete with 2 sets of jaws and adapter fitted for 10" lathe spindle. Code word YEZWE, weight 16 lb.
- No. U-770** 6" HEAVY DUTY UNIVERSAL CHUCK only less adapter. Code YIARS, wt. 12½ lb.
- No. U-770A** ADAPTER PLATE ONLY. Diameter 3-13/16", threaded for 10" lathe spindle, face semi-finished. Code YIAST, wt. 3½ lb.

JACOBS CHUCKS

For 10-Inch Lathes Only. 6" Lathe Chucks Are Described on Page 25—Armature Chuck Kits, Page 21.

HEADSTOCK CHUCKS

These Jacobs chucks are accurate and convenient for holding small-diameter work. Hollow construction permits handling long shafts through 10" lathe headstock spindle. Heat-treated steel jaws and body. Both sizes thread directly on 10" lathe spindle — No. 375 can be used in tailstock with 377 arbor (below, right).



- No. 375** JACOBS HEADSTOCK CHUCK, capacity 1/8" to 5/8" complete with key-type wrench. Can be used in tailstock with 377 arbor. Code word YAGYE, weight 4 lb.
- No. 377** ARBOR for 375 chuck only. Code word YAHUD, wt. 8 oz.
- No. 375B** JACOBS HEADSTOCK CHUCK, capacity 3/16" to 3/4" complete with key-type wrench. Code word YAHCO, wt. 5 lb.

CENTER REST CHUCK

The Jacobs center rest chuck supports armatures and shafts in the lathe tailstock. Adjustable durable bronze jaws form accurate bearing in which shaft rotates in exact position. No. 377 arbor is required to adopt chuck to 10" lathe tailstock.



- No. 445** JACOBS CENTER REST CHUCK, capacity 1/4" to 3/4". Code word YAHOC, weight 3 lb.
- No. 377** ARBOR required. Code word YAHUD, weight 8 oz.



CHUCK ARBORS

- No. 377** ARBOR to adapt 375 or 445 chuck to 10" lathe tailstock. Code YAHUD, weight 8 ounces.

DRILL CHUCK

Rugged Jacobs chuck for accurate drilling and countersinking. Heat-treated steel jaws and body. Adapted to 10" lathe headstock and tailstock spindles with No. 378 arbor (below).

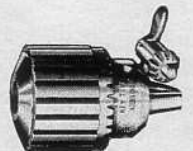

- No. 40-60** JACOBS DRILL CHUCK, capacity No. 70 drill to 1/2", complete with key-type wrench. Code YAHIB, weight 2 lb.



- No. 378** ARBOR to adapt No. 40-60 chuck to 10" lathe headstock or tailstock. Code word YAHYA, wt. 8 oz.

ACCESSORIES and TOOLS for 10" LATHES

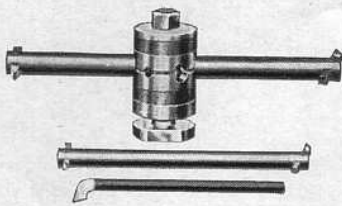

TURRET TYPE BORING SET

Provides maximum rigidity. Steel turret head has heavy clamp screw for locking bars in rigid position — replaces standard lathe tool post. $\frac{3}{8}$ " bar is solid high-speed steel — $\frac{1}{2}$ " and $\frac{3}{4}$ " bars have $\frac{3}{8}$ " and $\frac{1}{4}$ " high-speed cutters.

No. 970 TURRET TYPE BORING SET complete as shown. Code word YIBED, weight 8 lb.

FURNISHED: Turret head, $\frac{3}{4}$ " x 11" boring bar with two $\frac{1}{4}$ " high-speed cutters, $\frac{1}{2}$ " x 8" boring bar with two $\frac{3}{16}$ " high-speed cutters, $\frac{3}{8}$ " x 6" solid high-speed boring tool.

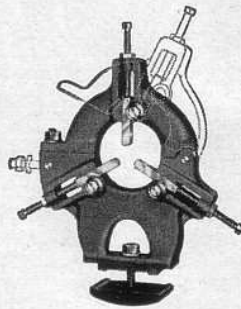

STEADY REST

Rigid support for accurately machining long pieces. Clamps to bed ways. Frame, base are strong iron castings; bronze jaws prevent scoring. Top hinged so that work may be inserted and removed without disturbing jaw settings.

No. 10-325A STEADY REST for 10" lathes, $2\frac{7}{8}$ " capacity. Code YIAWY, wt. 5 lb.



FOLLOWER REST

Insures accurate work on long slender rods. Quickly mounted on back of carriage dovetail slide. Ruggedly built — hardened steel jaws quickly adjusted and locked.

No. 425 FOLLOWER REST for 10" lathes. Code YAVNE, wt. 3 lb.

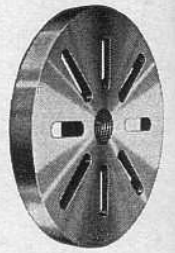

FACE PLATES

No. 365 is $8\frac{1}{2}$ " diameter for holding large work. Threaded to fit spindle nose of Atlas 10" lathes. Accurately machined grey iron casting, 8 slots for clamping work firmly in position.

No. 365 $8\frac{1}{2}$ " FACE PLATE. Code YAVSY, wt. 7 lb.

No. 15 6" FACE PLATE as furnished with Atlas 10" lathe. Code YEYMP, 3 lb.



CROTCH CENTER

Automatically centers round work in tailstock ram for accurate cross-drilling. V-slot carefully machined. Ground steel shank is No. 2 Morse taper. 2" diameter, 1" slot.

No. 356 CROTCH CENTER. Code YATRY, wt. 1 lb.

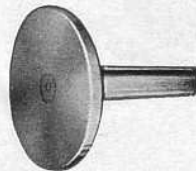

DRILL PAD

Mounts in tailstock ram as rigid brace for drilling flat or square work with drill in headstock. Shank is No. 2 Morse taper. Diam. face $3\frac{1}{8}$ ".

No. 360 DRILL PAD. Code YATOP, wt. $1\frac{1}{2}$ lb.



LATHE CENTER

Hardened, ground high-carbon tool steel with No. 2 Morse taper shank for headstock or tailstock.

No. 9-88 60° LATHE CENTER. Code word YAVAM, weight 8 oz.

No. 138 REDUCING SLEEVE. No. 3 to No. 2 Morse Taper. Code YEYLN, wt. 6 oz.

No. 790 CENTER EJECTOR BAR, length $13\frac{1}{2}$ ". Removes center without burring center or sleeve. Code word YEMPY, wt. 2 pounds.



BALL BEARING TAILSTOCK CENTER

Center point rotates on enclosed ball bearing — recommended for high-speed operations. Ideal for the average shop.

No. 348 BALL BEARING CENTER, No. 2 Morse taper shank. Code YEMMO, wt. 1 lb.



HEAVY-DUTY BALL BEARING TAILSTOCK CENTER

Center point turns with work — permits faster turning and deeper cuts on heavier work. Thrust load is carried by Timken tapered roller bearing; radial load by sealed precision ball bearing. Bearings are held by hardened and ground one-piece housing, packed with grease and sealed.

No. 348A BALL BEARING TAILSTOCK CENTER, No. 2 Morse taper shank. Code YIBYJ, weight $1\frac{1}{2}$ lb.

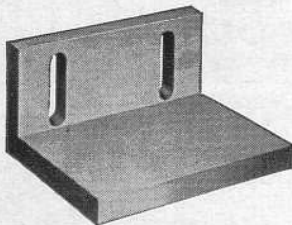

ANGLE PLATE

Simplifies off-center work and machining of odd-shaped pieces. Heavy casting machined to right angle. May be bolted to any point on face plate.

Horizontal Face — $6" \times 4\frac{3}{8}" \times \frac{5}{8}"$. Vertical Face — $6" \times 2\frac{3}{8}" \times \frac{5}{8}"$. Two Slots — $1\frac{1}{2}"$ (cc) x $\frac{1}{2}" \times \frac{3}{8}"$ thick.

No. 740 ANGLE PLATE. Code YAVYS, weight 10 lb.

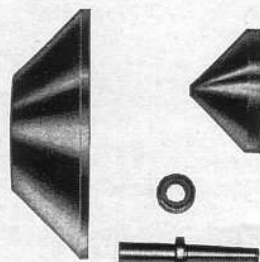

PIPE CENTERS

For supporting pipe in tailstock. Centering cones turn with work and are supported by tailstock arbor. Ball bearing absorbs thrust.

No. 755 SET OF PIPE CENTERS complete as shown. Code YAWAN, wt. 12 lb.

No. 757 PIPE CENTERING CONE, capacity 4" to 8". Code YEYTA, 9 lb.

No. 756 PIPE CENTERING CONE, capacity $\frac{1}{4}$ " to 4". Code YEYUZ, 3 lb.

No. 758A TAILSTOCK ARBOR, No. 2 MT shank. YEYVE, 2 lb.

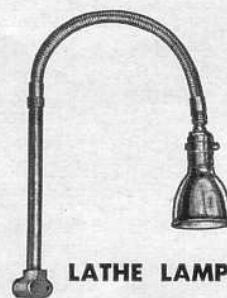

LATHE LAMP

The Atlas lathe lamp improves vision by throwing plenty of light directly on the work — eliminates eye glare by proper deflection. 15" flexible cable allows bulb and shade to be moved to any position. 11" rigid post clamps by mounting brackets to base of bed. Ball-joint in shade, push-thru switch.

No. 745 LATHE LAMP, cord, plug furnished. Code YAIKD, wt. 3 lb.

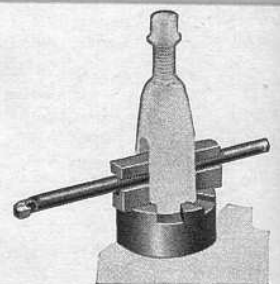

BORING TOOL HOLDER

Rigid support for boring tools. Clamp ring fits over tool post, has three slots at different heights to hold boring tools of $\frac{3}{16}$ ", $\frac{1}{4}$ ", $5/16$ " and $\frac{3}{8}$ " diameter in tool post slot. Tool post screw tightens V-block and plain block on boring tool.

No. 990 BORING TOOL HOLDER with clamp ring, V-block, plain block and one $\frac{1}{4}$ " high speed boring tool. Code YIBOG, wt. 1 lb.

ACCESSORIES and TOOLS for 10" LATHES



MOTOR DRIVEN MICA UNDERCUTTER

For servicing armatures. Attaches to back of carriage cross slide where it can be put in action in a second or moved out of way when not in use. Saw is fed through mica by turning lathe carriage hand-wheel — the new grooves are always clean, square, parallel, and uniform in depth. Height of cutter arbor is adjusted by elevation screw with hand-wheel control. Saw arbor driven by Dumore motor. Capacity under arbor, 5".

No. 510 MICA UNDERCUTTING ATTACHMENT for Atlas 10" lathes, complete as shown. Dumore motor, 105-125 volt, 25-60 cycle AC, 105-125 volt DC. Furnished: Set of 5 high speed under-cutting saws (.015", .020", .025", .030" and .035"), extension cord, switch, plug. Code word YAMFE, wt. 11 lb.

No. 523A SET OF 10 HIGH SPEED SAWS (two each: .015", .020", .025", .030", .035"). Code YETUV, wt. 2 oz. Per set of ten.



ARMATURE CHUCK KIT

Contains two Jacobs chucks: center rest bearing chuck to support armature shaft in tailstock, and headstock chuck for driving. Key-type wrench, recessed-type arbors, attractive case.

No. 9-441 CHUCK KIT. Arbors for No. 2 Morse taper spindles. Code YEJOJ, wt. 8 lb.



COIL WINDING ATTACHMENT

Simplifies accurate coil winding. Replaces tool post — has fibre wire-guide and spring adjustment on spool for correct tension. Quickly mounted and removed.

No. 780 COIL WINDING ATTACHMENT. Code word YAWEP, weight 2 lb.

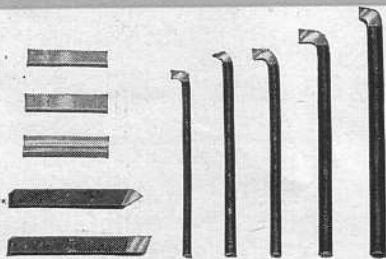

TOOL-POST TOOL SET

High speed, ready-ground boring and turning tools. Solid, one-piece construction . . . held directly in tool post. Ideal for accurate jobs requiring rigid tool mounting.

No. 380 TOOL-POST TOOL SET complete; 5 internal tools, 2 heavy-duty external tools, V-block, 2 height spacers. Code word YARYP, weight 2 lb.



1/4" CUTTER BITS

High speed 1/4" x 1/4" cutter bits, ready-ground for use in Atlas tool holders. Set of 6 permits wide range of operations. 3/8" unground bits for use in tool post also listed.

No. 386 SET OF 6 FORMED CUTTER BITS 1/4" x 1/4". Includes bits shown. Code word YARJA, weight 1 lb.

No.	Description	Code
3865	Set of 6 Unground 1/4" cutter bits	YARKE
386T	Set of 12 Unground 1/4" cutter bits	YARMO
3855	Set of 6 Unground 3/8" cutter bits	YARPY



TOOL HOLDERS

Drop-forged special steel, accurately machined, heat-treated. Alloy steel set-screws heat treated. Slot is accurately machined for 1/4" cutter bits — 3/8" shank fits tool post slot. Set of 3 handles all turning, facing operations.

No. 139L LH TOOL HOLDER. Code YAUDZ, wt. 1 lb.

No. 139R RH TOOL HOLDER. Code YAUHD, wt. 1 lb.

No. 139 STRAIGHT TOOL HOLDER. Code YAUCY, wt. 1 lb.



KNURLING TOOL

Floating construction makes rollers self-centering. Hardened tool steel rollers form gripping surface for handles, nuts, markers, etc.

No. 340 KNURLING TOOL, medium diamond-shape knurls. Code YAUSP, wt. 1 lb.

No. 343 EXTRA KNURLS, medium-diamond. Code YEGYJ, wt. 2 oz. Per pair.



CUT-OFF TOOL

Quick, clean cut-offs. Drop-forged RH holder with 3 1/2" high speed replaceable blade, ready-ground. Sharpen front edge only.

No. 590 CUT-OFF TOOL with blade. Code word YAUJF, weight 1 lb.

No. 592 EXTRA BLADE. Code YAURN, 4 oz.

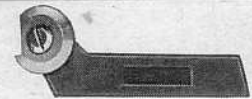

THREADING TOOL

Ground to cut 60° threads. Resharpener easily, accurately by grinding top edge only. RH holder. Clamp screw holds tool rigidly.

No. 430 THREADING TOOL. Code word YAUXT, weight 1 lb.

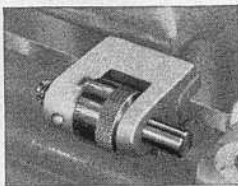

STOPS

MICROMETER CARRIAGE STOP simplifies accurate duplicate work on turning, boring, facing. Clamps on front bed way. Will not automatically stop carriage.

No. 10-315 CARRIAGE STOP. Code YIAZB, wt. 2 lb.

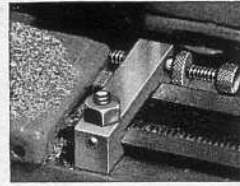

CROSS SLIDE STOP shows depth to stop cross feed. Clamps to cross slide dovetail. Will not automatically stop cross feed.

No. 725 CROSS SLIDE STOP. Code YAIBT, wt. 8 oz.

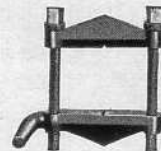

CLAMP DOG

For holding square, rectangular, hexagonal, or round work. Clamp bars forged steel, screws heat treated.

No. 741 CLAMP-TYPE DOG. Opens 2 1/4". Code word YAPGA, wt. 1 lb.



DOGS

No. 142A SET OF 4 LATHE DOGS to handle diameters up to 1 1/2". Code word YAPAG, wt. 2 lb.

No.	Opening	Weight	Code
142	1/2"	4 oz.	YAOPK
143	3/4"	5 oz.	YAORM
144	1"	7 oz.	YAOWR
145	1 1/2"	10 oz.	YAOZT

LATHE COOLANT SYSTEMS

Fitting every type of bench lathe, turret lathe or screw machine, an Atlas coolant system now makes it possible to boost production, cut tool wear, and improve work finish at very low cost. The complete, compact system can be installed on any machine in a few minutes, and switched from one machine to another if desirable.

Powerful new-type gearless coolant pumps of centrifugal design are engineered for long, trouble-free service. Single moving part, no metal-to-metal contact, and a hydraulically balanced shaft and impeller give smooth, quiet operation under tough operating schedules.

Heavy-gauge steel, leakproof welded tanks have removable covers. Feed and return tubing is of tough extruded plastic, non-kinking and impervious to oil, caustic, disinfectant, etc.

Induction or Universal motors are completely enclosed, turn on oilite bronze bearings.

Everything necessary for quick installation and full operation is included in the packaged units described below.



PLASTIC RETURN HOSE

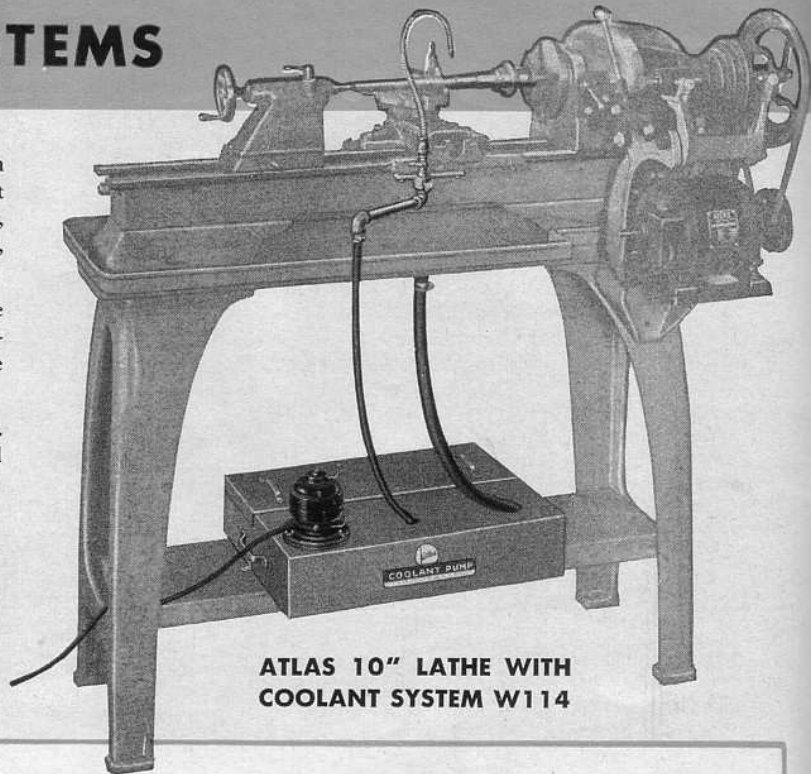

ATLAS 10" LATHE WITH COOLANT SYSTEM W114

COMPLETE PACKAGED UNITS . . . READY TO INSTALL QUICKLY

PUMPS and TANKS

(Select capacity desired from chart below)

No. W89
UNIVERSAL PUMP



5 GALLON TANK
14 1/8" x 20 3/8" x 4 1/4",
Universal Motor: 110-120 volt AC-DC, 6000 RPM.

FEED and RETURN SYSTEMS

(Two Selections)

No. W96
for
ATLAS
LATHES

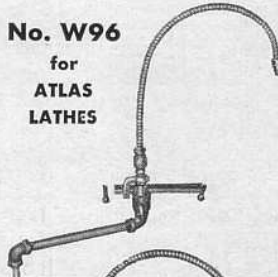

W114

No. W89 universal coolant pump, tank and No. W96 feed and return unit with lines.

W115

No. W89 universal coolant pump, tank and No. W97 feed and return unit with lines.

Either system available with motor for 220-230 volt AC-DC current at small extra cost.

No. W88

INDUCTION PUMP



2 1/2 GALLON TANK
12 1/8" x 12 3/8" x 4 1/4",
Induction type Motor:
110-120 volt, 50-60 cycle AC, 3450 RPM.

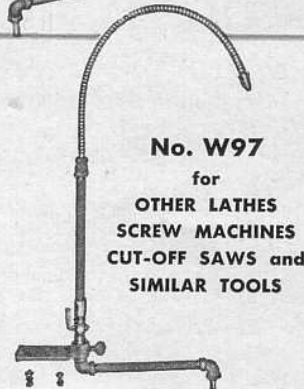

No. W97

for
OTHER LATHES
SCREW MACHINES
CUT-OFF SAWS and
SIMILAR TOOLS

ORDER No.

INCLUDES

W111

No. W88 induction coolant pump, tank and No. W96 feed and return unit with lines.

W112

No. W88 induction coolant pump, tank and No. W97 feed and return unit with lines.

Either system available with motor for 220-230 volt 60 cycle single phase current at small extra cost.

PUMPING CAPACITIES

No.	Outlet Elevation Above Motor	Gallons per Hour	
		Soluble Oil (50% Solution)	Lard Oil (70° F.)
W89	Level	450	150
	1 ft.	360	108
	2 ft.	300	90
	3 ft.	252	66
	4 ft.	240	60
	5 ft.	216	54
W88	Level	225	90
	1 ft.	198	78
	2 ft.	180	54
	3 ft.	162	38
	4 ft.	126	23
	5 ft.	114	10

OIL PANS FOR ATLAS 10" LATHES



No.	For Bed Lengths:	Overall	Code	Wt.
10-775A	36" & 42"	45" x 18" x 1 1/4"	ZEKAB	17 lb.
10-775C	48" & 54"	57" x 18" x 1 1/4"	ZEJZA	24 lb.

Heavy-gauge, leakproof-welded, especially designed to accommodate Atlas 10" lathes. Reduced width at left to accommodate countershaft. Welded outlet nipple for 3/4" ID return hose, 4 oilproof gaskets furnished. Two sizes. Note: We do not manufacture special pans.

Atlas 6" BACKGEARED SCREW-CUTTING LATHE

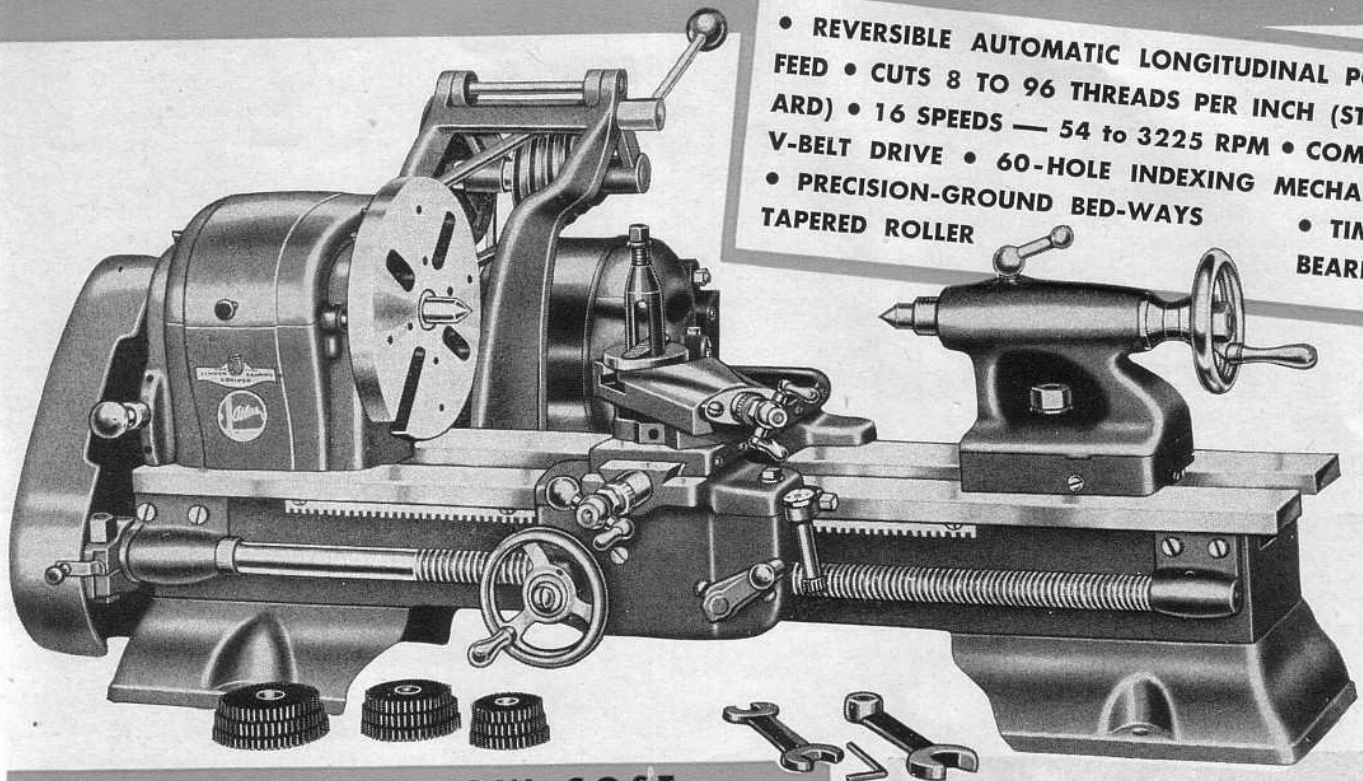

THE FIRST LOW-COST PRECISION-BUILT SMALL LATHE

The exceptional value of this rugged Atlas machine tool is a tribute to modern manufacturing methods. Included in its modern, compact design are these features: Timken-equipped backgeared headstock, V-belt drive, precision-ground bed, 16 spindle speeds, reversible automatic longitudinal power feed, wide thread-cutting range.

Using special-built machinery, rigid inspections at each stage of part-machining, efficient line production assembly, and thorough performance tests of the completed lathe, Atlas is able to produce this 6" lathe with a guaranteed accurate alignment of spindle, tailstock, carriage, and bed ways to within .001 inch in all horizontal and vertical planes.

ACCURACY BUILT IN STEP BY STEP

Beginning with the heavy bed, accuracy is built into the 6" lathe step by step. The entire bed is a heavy massive casting of close-grained semi-steel iron. Ways and leg pads are first rough-milled, then the casting is seasoned and finish-milled until all eight surfaces align within .001 inch in all planes.

Headstock, tailstock, and carriage are hand-fitted to the bed ways. The carriage has six full-length bearings on the bed, each 5" long. The tailstock has four full-length bearing surfaces, each 3 5/8" long. Both headstock and tailstock have take-up adjustments. The large way-bearings plus take-up adjustments guarantee long-lived accuracy under heavy loads.

Timken roller bearings in the headstock carry all spindle loads with minimum friction and permit a wide range of sixteen speeds between 54 and 3225 RPM.

The backgeared drive, powered completely by V-belts, delivers a smooth, even flow of power. Adjustable countershaft is mounted on bench within easy reach for speed changes. Sixty holes in front spindle gear provide indexing mechanism for dividing operations. Threading dial, gears, and chart are furnished for cutting all standard threads between 8 and 96 per inch.

No. 618 6" BACK-GEARED SCREW-CUTTING LATHE. Complete as shown, less motor, with equipment listed at right. Code word YEDUF, shipping wt. 100 lb.

No. 2520B SINGLE PHASE MOTOR. 1/2 H.P., 1725 R.P.M., Capacitor-Start Ball Bearings, 110/220 volt, 60 cycle, 1/2" single end shaft, 10-ft. SJ approved cord and plug. Code word ZEWOR, wt. 33 lb.

SPECIFICATIONS

CAPACITY

Swing Over Bed.....	6"
Swing Over Carriage.....	4 7/8"
Capacity between Centers.....	18"
Threading Range.....	8 to 96 Standard, Right or Left Hand — Metric, 5 to 3 mm. Standard
Collet Capacity.....	.9/32" (see page 25)
Overall Dimensions.....	33 1/2" x 27" x 12" high

SPEEDS AND FEEDS

Sixteen Speeds.....	54, 82, 122, 140, 187, 287, 317, 365, 481, 550, 820, 940, 1250, 1925, 2125, 3225 RPM
Feeds (Left or Right) per Revolution of Spindle.....	.0104", .0078", .0048", .0039" or .0024"
Lead Screw.....	1/2" Diam., 16 Acme Threads per inch

DRIVE UNIT

Motor Recommended.....	1/3 H.P., 1725 R.P.M.
Motor Mounting.....	Bench
Countershaft Spindle Bearings.....	Oilite Bronze

HEADSTOCK

Spindle Bearings.....	Timken Tapered Roller Bearings with Thrust Take-up Collar and Nut
Spindle Nose.....	1" Diameter, 10 Pitch NF Threads
Spindle Nose Taper.....	No. 2 Morse Taper
Hole Through Spindle.....	.17/32"
Back Gears.....	20 Pitch, 3/8" Wide
Backgear Shaft Bearings.....	Oilite Bronze
Spindle Gear.....	24 Pitch, 32 Teeth, 7/16" Wide

CARRIAGE

Cross Feed Travel.....	4 3/4"
Cross Feed Screw.....	3/8" Diameter, Acme Thread
Tool Post Slide Travel.....	1 3/4"
Tool Post.....	3/8" x 3/4" slot to take 3/8" bits or tool holder for 3/16" bits

TAILSTOCK

Tailstock Ram.....	3/4" Diam. Bored for No. 1 Morse Taper
Tailstock Ram Travel.....	1 1/4"
Tailstock Set-Over, Forward or Back.....	9/16"

EQUIPMENT FURNISHED

Reversible Automatic Power Longitudinal Feed; Graduated Compound Rest; Tool Post, Ring and Rocker, 3/8" Tool Bit; Complete Set of Change Gears to cut standard threads between 8 and 96 per inch; Threading Chart, Threading Dial; Quick-Change Countershaft; Complete V-Belt Drive; Motor Pulley furnished is for 1/2" diameter motor shaft — prices for other size motor shafts on request; 60-Hole Indexing Mechanism; 5 1/2" Combination Metal and Woodworking Face Plate; Two 60° Lathe Centers — No. 2 Morse Taper for headstock, No. 1 Morse Taper for tailstock; 3 Wrenches; Instruction Booklet. Finish, gray.

6-INCH LATHE ATTACHMENTS (1)

FOR 6-INCH LATHES ONLY
10' Lathe Attachments are Described on Pages 13-22



STEADY REST

Clamps to the bed ways and serves as rigid work support to insure accuracy in turning, boring, and threading long pieces. Frame and base are strong grey iron castings. Bronze jaws prevent scoring work. Each jaw can be adjusted easily and locked in exact position for proper work bearing.

No. M6-325 STEADY REST for Atlas 6" lathes, capacity 2 3/8" diameter. Code word YEFHY, wt. 3 lb.



FOLLOWER REST

Insures accurate work on long slender rods. Mounted quickly and easily on the back of the carriage dovetail slide and follows the cutting tool, holding the work in rigid position. Ruggedly built—hardened steel jaws quickly adjusted and locked.

No. M6-395 FOLLOWER REST for Atlas 6" lathes. Code YEFID, 2 lb.

TAPER ATTACHMENT

A typical Atlas development—the first accurate, sensibly priced taper attachment. It is quickly installed, simple to operate, and makes accurate taper work a fast, easy job. The rectangular slide bar has rigid grey-iron bracket supports. A slotted draw bar connects to carriage cross slide and feeds tool at desired taper. Easy-to-read index plate is graduated 7° and 3" both sides of center line.

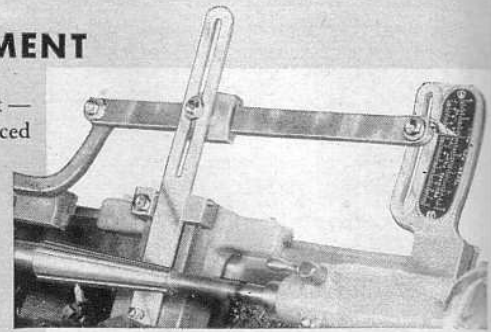

No. M6-700 TAPER ATTACHMENT for Atlas 6" lathes. Code word YEITS, weight 4 1/2 lb.

Maximum travel, one setting.....7 1/4"
Range, right or left.....7° (2-15/16" per ft.)

MILLING ATTACHMENT

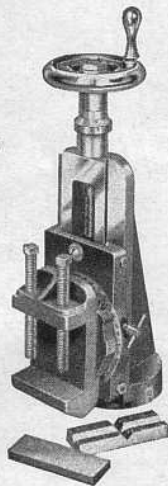

Clamps in place of compound rest for face-milling, routing, cutting keyways and slots, milling dovetails, squaring and spinning shafts, making dies, molds, etc. Vise slide is graduated in degrees, and vise swivels to hold work at any angle.

No. M6-500 MILLING ATTACHMENT. Complete as shown with flat block, V-block. Code YEILK, wt. 10 lb.
Vertical Feed 1 3/4" Vise Capacity..... 2"
Cross Feed..... 3 3/8" Jaw Depth..... 3/4"
Overall Ht..... 11 1/2" Jaw Width..... 2"



CUTTER HOLDING SET

Holds milling cutter in headstock spindle.
No. M6-945 CUTTER HOLDING SET. Includes draw bar, sleeve, arbor for 1/2" shank cutters. Code YEYBD, wt. 2 lb.



R. H. SPIRAL END MILLS

For general milling. Straight shank—adapted to holding set with collet bushings below. Wt. 4 oz. each.

No.	Lgth.	Flute	Diam.	Code
576A	5/8"	1/4"	1/4"	YAKCE
576B	1 1/16"	5/16"	5/16"	YAKEC
576C	3/4"	3/8"	3/8"	YAKFO
576D	7/8"	7/16"	7/16"	YAKID
576E	1 5/16"	1/2"	1/2"	YAKOF



COLLET BUSHINGS

Required to adapt 576 end mills to M6-945 holding set. Not required for 576E end mill.

No. 563E FOUR COLLET BUSHINGS. Code YALED, wt. 6 oz.

ANGULAR CUTTERS

For face-milling, dovetailing, and cutting angles less than 90°. Threaded hole—adapted to M6-945 set with arbors listed below. Wt. 6 oz. each.

No.	Thick	Diam.	Hole	Thread	Code
574A	7/16"	1 1/4"	3/8"	24	YALIF
574B	9/16"	1 3/8"	1/2"	20	YALJY

ADAPTER ARBORS required to adapt 574 cutters to M6-945 set.

No.	For No.	Wt.	Code
572	574A	8 oz.	YEWTE
567	574B	8 oz.	YEWUX

WOODRUFF KEYWAY CUTTERS

For Woodruff keyways, slots, grooves, T-slots. 1/2" straight shank—held in arbor of M6-945 set.

No.	Diam.	Thick	Code
575A	1/2"	1/8"	YALUH
575B	3/4"	3/16"	YALYJ
575C	1"	1/4"	YAMAD
575D	1 1/8"	5/16"	YAMDA
575E	1 1/4"	3/8"	YAMEF

Wt. 6 oz. each.

MOTORS

No. 2520B 1/3 HP 1725 RPM SINGLE PHASE CAPACITOR-START BALL BEARING MOTOR: 110/220 volt, 60 cycle 1/2" single-end shaft, 10 ft. SJ approved cord and plug. (Develops full power instantly under load without drawing excess current.) Code ZEWOR, wt. 33 lb.

THREE PHASE MOTORS

Nos. 2630 and 2635 are designed for use with three phase current. Both are 1/3 HP, 1725 RPM. 60 cycle—have SKF ball bearings, 1/2" single-end shaft. Furnished with BX connector in terminal box—do not have switch, cord or plug.

No.	HP	Volt	Wt.	Code Word
2630	1/3	220	28 lb.	ZEWPE
2635	1/3	440	30 lb.	ZEWYT

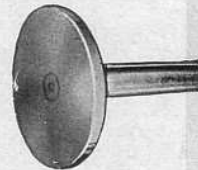

DRILL PAD

Mounted in the tailstock ram, serves as a rigid support for drilling flat or square work with drill held in headstock. Ground steel shank is No. 1 Morse taper.

No. L2-360 DRILL PAD, No. 1 Morse taper shank, 3 3/8" diam. face. Code word YATPO, wt. 12 oz.

CROTCH CENTER

Automatically centers round work in tailstock ram for accurate cross-drilling. V-slot is accurately machined—ground steel shank is No. 1 Morse taper.

No. L2-356 CROTCH CENTER, No. 1 Morse taper shank, 2" diameter, 1" slot. Code YATYR, wt. 12 oz.



DOGS

Drop-forged steel. Hold work firmly, transmit maximum power.

No. 142A SET OF 4 DOGS for diameters up to 1 1/2". Code word YAPAG, wt. 2 lb.

No.	Opening	Wt.	Code
142	1/2"	4 oz.	YAOPK
143	3/4"	5 oz.	YAORM
144	1"	7 oz.	YAOWR
145	1 1/2"	10 oz.	YAOZT



CLAMP DOG

Holds rectangular, hexagonal, round work. Mounts without removing work from lathe centers.

No. 741 CLAMP DOG. Opens 2 3/4". Code YAPGA, wt. 1 lb.



CARRIAGE STOP

Clamps to bed way, indicates accurate carriage stopping point.

No. 10-315 Code YIAZB, wt. 1 lb.



CROSS SLIDE STOP

Clamps to cross slide dovetail, sets depth of duplicate cuts.

No. M6-725 Code YEMKE, wt. 8 oz.

REVERSING SWITCH

Essential for grinding, tapping, nut-setting, finishing. The M6-420 is a dependable drum-type switch with durable contacts of hard-rolled copper. It is furnished with mounting bracket which places knobbed lever control in handy position.

Operates on single phase, capacitor and 3-lead repulsion-induction motors (not 4-lead)—also both shunt-wound and compound-wound DC. Prices for 3-phase on request.

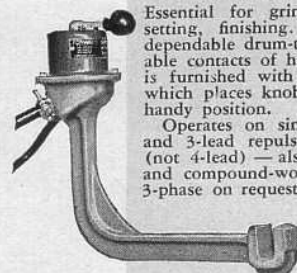

No. M6-420 REVERSING SWITCH complete with mounting bracket, cable connections and installation diagram. Code word YEYOY, wt. 5 lb.

FOR 6-INCH LATHES ONLY
10" Lathe Attachments are Described on Pages 13-22

6-INCH LATHE ATTACHMENTS (2)

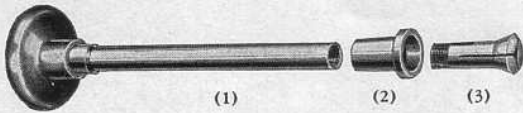

DRAW-IN COLLET CHUCK ATTACHMENT

For chucking diameters between 1/32" and 9/32" when maximum accuracy is required. Consists of (1) hollow draw-in spindle which extends through the lathe spindle, (2) tapered closing sleeve, and (3) split holding collets.

Draw-in spindle is threaded to hold collet in tapered sleeve. Hollow construction permits rods to be passed through lathe spindle — handwheel control releases and tightens collet on work. Closing sleeve is ground inside and outside to insure maximum accuracy. Lathe must be stopped to open and close collet.

Atlas split collets are collet tool steel, heat-treated and ground inside and outside. One end threads on draw-in spindle, and other end is ground to fit tapered sleeve. Keyway prevents collet from turning. Collets are available in 1/32nds between 1/32" and 9/32" — one collet is furnished with collet attachment (any size in 1/32nds between 1/32" and 9/32").

No. M6-750 DRAW-IN COLLET CHUCK ATTACHMENT Complete: draw-in spindle, tapered closing sleeve, and one split holding collet listed below — specify diameter. Code word YEHYK, wt. 2 lb.

No. M6-751 SPLIT HOLDING COLLET — Specify diameter. Available in 32nds between 1/32" and 9/32" as follows: 1/32", 1/16", 3/32", 1/8", 5/32", 3/16", 7/32", 1/4" and 9/32". Code word YEIBZ, wt. 4 oz. each.

No. M6-548 SPINDLE NOSE CAP to protect lathe spindle threads (6" lathes). Code word YELLO, weight 8 oz.

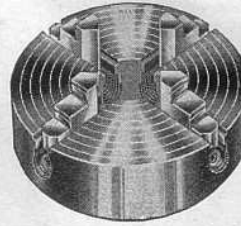

4" INDEPENDENT CHUCK

For work of all shapes. Body is high-strength semi-steel casting. Special alloy machinery steel hand-fitted jaws have raised, ground steps. Screws heat-treated alloy steel.

No. U6-439 4-JAW INDEPENDENT CHUCK 4" diam. Threaded for Atlas 6" lathe spindle. Wrench furnished. Code YIALM, wt. 6 lb.

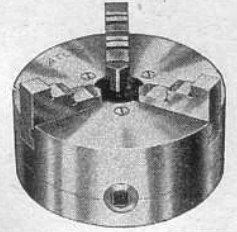

4" UNIVERSAL CHUCK

Self-centering jaws controlled by single screw for quickly centering round and hexagonal work. Handles 1/2" rods through the headstock. Body is high-strength semi-steel.

No. U6-437 4" 3-JAW UNIVERSAL CHUCK complete with inside and outside jaws and wrench. Threaded for 6" lathe spindle. Code word YIAJK, weight 5 lb.



ARMATURE CHUCK KIT

Jacobs center rest (bearing) chuck to support shaft in tailstock, Jacobs headstock (driving) chuck. Recessed arbors, metal case.

No. M6-441 CHUCK KIT for Atlas 6" lathes — headstock chuck with No. 2 MT arbor, center rest chuck with No. 1 MT arbor. Code word YEJLY, weight 8 lb.

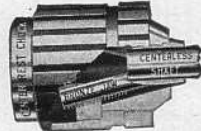

CENTER REST CHUCK

Supports shafts in tailstock.

No. 445 JACOBS CENTER REST CHUCK, capacity 1/4" to 3/4". Code word YAHOC, wt. 3 lb.

No. M6-377 ARBOR (required). Code word YEELJ, wt. 8 oz.

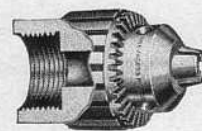

HEADSTOCK CHUCK

For holding small work.

No. M6-375 JACOBS HEADSTOCK CHUCK, capacity No. 70 drill to 17/32", complete with key-type wrench. Code YEEBY, wt. 3 lb.

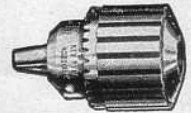

DRILL CHUCK

For accurate drilling and countersinking.

No. 40-60 JACOBS DRILL CHUCK, capacity No. 70 drill to 1/2", with key-type wrench. Code YAHIB, 2 lb.

No.	Arbor for	Wt.	Code
L2-378	Tailstock	8 oz.	YECOC
378	Headstock	8 oz.	YAHYA

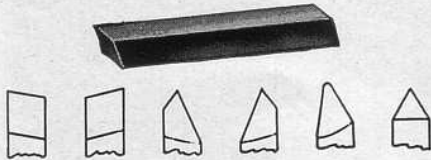

3/16" CUTTER BITS

Six high-speed cutters, ready ground to shapes shown: R. H. turning, L. H. turning, R. H. facing, L. H. facing, round nose, 60° V-threading. 3/8" and 3/16" unground cutter bits are also listed below.

No. M6-386 SET OF 6 FORMED CUTTER BITS 3/16" x 3/16". Includes bits shown above. Code YEGCA, wt. 1 lb.

No.	Description	Wt.	Code
M6-386S	Six 3/16" Ungrd. Bits	1 lb.	YEZAV
M6-386T	Twelve 3/16" Ungrd. Bits	1 1/2 lb.	YEZIX
385S	Six 3/8" Ungrd. Bits	1 1/2 lb.	YARPY

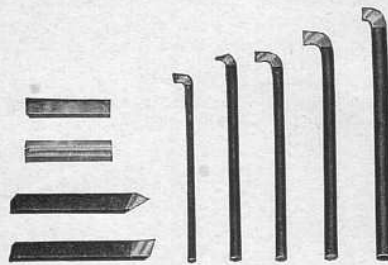

TOOL-POST TOOL SET

Seven high-speed boring and turning tools ground as shown: 3/8" external 60° V-threading, 3/8" external turning, 3/16" boring, 1/4" internal threading, 1/4" boring, 5/16" boring, 3/8" boring, spacer and V-block.

No. M6-380 TOOL-POST TOOL SET complete: 5 internal tools, 2 heavy-duty external tools, V-block, height spacer. Code word YEFYH, wt. 2 lb.

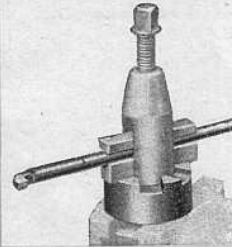

BORING TOOL HOLDER

Clamp ring fits over tool post, has three slots to hold boring tools of 3/16", 1/4", 5/16" and 3/8" diameter. Tool post screw tightens V-block and plain block on tool.

No. M6-990

BORING TOOL HOLDER with clamp ring, V-block, plain block and one 1/4" high speed boring tool. Code YIBUH, wt. 1 lb.

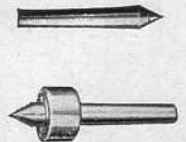

60° CENTERS

No.	Morse Taper	Code
L2-80	No. 1	YAVEN
9-88	No. 2	YAVAM
M6-138	No. 2 to 1 Sleeve	YEHHO

Wt. 8 oz. each.

No. M6-348

BALL BEARING TAILSTOCK CENTER, No. 1 Morse taper. (Center point rotates on ball bearing.) Code YEJJO, wt. 8 oz.



TOOL HOLDERS

Shank fits tool post, head broached for 3/16" cutter bits shown above. Wt. 4 oz. each.

No.	Description	Code
M6-139L	L. H.	YEFAB
M6-139R	R. H.	YEFBA
M6-139S	Straight	YEEWT



CUT-OFF TOOL

Drop-forged holder with 3/4" high speed replaceable blade for quick, clean cut-offs.

No. M6-590 CUT-OFF TOOL with blade. Code word YEFCE, weight 8 oz.

No. M6-592 Extra Blade. Code word YEHDA, wt. 4 oz.



THREADING TOOL

Drop-forged L. H. holder with blade ground to cut 60° threads. Resharpen top edge only.

No. M6-430 THREADING TOOL. Code word YEFFO, wt. 8 oz.



KNURLING TOOL

Self-centering floating construction — heavy steel shank.

No. M6-340 KNURLING TOOL with medium diamond-shaped knurls. Code YEFEC, wt. 8 oz.

No. 343 Extra Knurls, medium diamond. Code word YEGYJ, weight 2 oz. Per pair.

6-INCH LATHE ATTACHMENTS (3)

FOR 6-INCH LATHES ONLY
10-Inch Lathe Attachments are Described on Pages 13-22

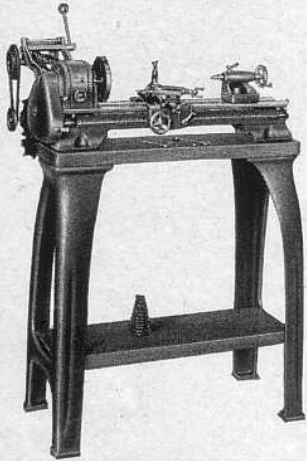

FLOOR STAND

Permanently rigid lathe support—saves valuable floor space. Legs are heavy grey iron castings, thickly ribbed and cross braced. Table boards are 1 7/8" thick, thoroughly seasoned, shellacked, varnished, and ready-drilled for quick assembly. Large bottom board is convenient for holding chucks, wrenches, gears, and other tools and accessories. Motor mounting bracket and counter-shaft support are furnished.

No. M6-800A FLOOR STAND for No. 618 lathe. Code YELYN, wt. 140 lb.

LATHE LAMP

For 6-Inch Lathes

Throws plenty of light on work. Has 14" flexible cable and ball joint at shade. Mounting bracket clamps at base of bed. 6-ft. rubber cord and plug furnished.

No. M6-745 6" LATHE LAMP. Code word YEERP, weight 2 lb.

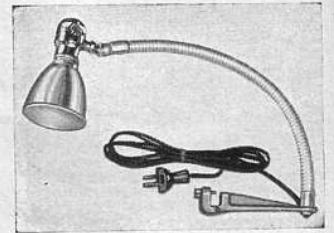

MICA UNDERCUTTER

The Atlas 618 lathe can be equipped for armature reconditioning at reasonable cost—write for details. Armature chuck kit, page 25.

The No. M6-510 motor-driven undercutting attachment makes short work of mica undercutting and puts real profit in armature jobs. It is mounted quickly on the carriage cross slide and moved easily out of the way when not in use.

No. M6-510 MICA UNDERCUTTER for 6" lathes. Code YEEVS, weight 9 lb. Maximum working diameter.....4"

FURNISHED: Dumore motor 105-130 volt A.C. or D.C. 25-60 cycle. Set of 5 high speed saws (.015", .020", .025", .030", .035"), extension cord, switch and plug.

No. 523A SET OF 10 HIGH SPEED SAWS (2 each of following thicknesses: .015", .020", .025", .030", and .035"). Code YETUV, wt. 2 oz.

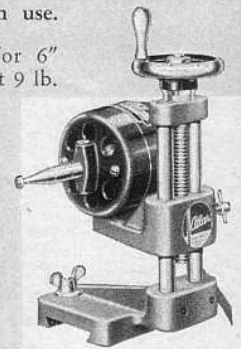

CENTER EJECTOR BAR

Removes center from spindle without burring center or sleeve. Steel shaft has knurled ball grip—brass head cannot damage center sleeve, or spindle.

No. M6-790 CENTER EJECTOR BAR. Length 10". Code word YETWY, wt. 1 1/2 lb.



COIL WINDER

Si-mp-lifies accurate coil winding. Replaces tool post—has fibre wire guide and spring adjustment on spool for correct tension. Quickly mounted and removed.

No. M6-780 COIL WINDER. Code YEMIL, wt. 1 1/2 lb.

WOODWORKING ATTACHMENTS

FOR ATLAS 6-INCH AND 10-INCH LATHES

Sturdy, rigid construction and an exceptionally wide range of spindle speeds make the Atlas lathes ideal machines for woodworking as well as machining all types of metals and plastics.

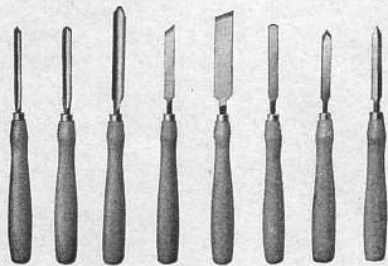

WOODTURNING CHISELS

Professional-type chisels with tool steel blades scientifically heat treated. Extra long handles are polished maple with strong brass ferrules. Approximate length, 14 inches.

No. W13A SET OF 8 CHISELS as shown. Code word YAZWY, weight 6 pounds

Chisel	No.	Code
1/4" Gouge	W13-1	YAYPA
1/2" Gouge	W13-2	YAYSO
1" Gouge	W13-3	YAYUT
1/2" Skew	W13-4	YAYVY
1" Skew	W13-5	YAZER
1/2" Round Nose	W13-6	YAZRE
1/2" Spear Point	W13-7	YAZTO
1/2" Parting	W13-8	YAZUV

Weight 1 lb. each

COMBINATION FACE PLATE

For 10-Inch Lathes

An 8 1/2" diameter face plate for wood and metal operations. Threads on 10" lathe spindle; has holes for wood screws and four 1/2" slots for metal work.

No. L5-365 COMBINATION FACE PLATE for 10" lathe. Code word YAVUR, weight 8 lb.



SPUR CENTERS

For driving work mounted between centers. Ground and hardened steel with replaceable center point. Morse taper shanks.

No.	Shank	Wt.	Code
350	No. 2 Morse Taper	1 lb.	YAWTY
L2-16	No. 1 Morse Taper	8 oz.	YEAHZ
M6-138	No. 2 to No. 1 Sleeve	6 oz.	YEHHO
L3-147	Extra Point for No. 350	2 oz.	YEWIV
147	Extra Point for No. L2-16	2 oz.	YEWSA

CUP CENTERS

Supports work in tailstock. Ground and hardened steel with replaceable center point. Morse taper shanks.

No.	Shank	Wt.	Code
351	No. 2 Morse taper	1 lb.	YAWUS
L2-17	No. 1 Morse taper	8 oz.	YEACY
L3-147	Extra Point for No. 351	2 oz.	YEWIV
147	Extra Point for No. L2-17	2 oz.	YEWSA



SCREW CENTERS

For facing and hollowing operations. Alloy steel with replaceable center. Morse taper shank. Diameter 2".

No.	Shank	Wt.	Code
352	No. 2 Morse Taper	1 lb.	YAWYT
L2 352	No. 1 Morse Taper	8 oz.	YEAHD
M6-138	No. 2 to No. 1 Sleeve	6 oz.	YEHHO
355	Extra Center Point	2 oz.	YEYEV

SMALL FACE PLATE

For 10-Inch Lathes

No. L4T-15 is a 3 1/2" face plate for woodworking. Threads directly on 10" lathe spindle nose and has three holes for wood screws.

No. L4T-15 WOODWORKING FACE PLATE. Code word YELOL, wt. 2 lb.

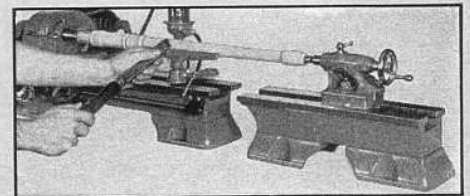

EXTENSION BEDS

For handling extra long wood work. Machined and finished to same specifications as lathe bed.

No.	For	Length	Wt.	Code
L-13	10" Lathes	18"	40 lb.	YATLF
M6-1E	6" Lathes	16 1/2"	24 lb.	YEMEK

HAND REST

Clamps to bed and furnishes rigid support for chisel. Has sliding clamp plate to protect bed. T-rest can be swivelled to any position and locked securely with hand clamp. Two T-rests are furnished.

No.	For	Wt.	Code
330	10" Lathes	6 lb.	YAWOR
M6-330	6" Lathes	3 lb.	YEFOF



HAND REST SWIVEL

For 10-Inch Lathes

Clamps to carriage in place of compound rest—can be turned and locked at any angle. Furnished complete with 4", 8", and 12" T-rests. When ordering, please give lathe serial number or year purchased.

No. W27A HAND REST SWIVEL for 10" lathes, complete with 4", 8", and 12" T-rests. Code YAWRO, wt. 4 lb.

YOU'LL SAVE ON DOZENS OF SMALL JOBS WITH AN

Atlas

SHAPER

ARE you operating a large shaper for small jobs — tying up a big investment and paying high costs for set-up and operation — when the greater portion of your work requires a stroke of 7 inches or less?

The Atlas handles such jobs quickly, easily, and economically. It's compact, it's easy to set up and get in motion — it's fast, powerful, and accurate. Initial investment is extremely low and the 1/2 HP motor keeps operating costs at a minimum.

Here is a machine tool with all the accuracy, power, strength, and versatility of larger shapers built down to scale for machining small work. The record of efficiency and durability of the Atlas shaper in thousands of shops is the result of careful selection of materials, modern machining methods, and thorough inspection at every stage of construction.

We believe you will find many ways to put this economical shaper profitably at work in your plant, either in the tool room or on production work where shaping is indicated. The following pages present complete construction details and specifications.

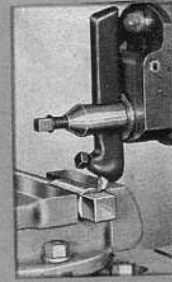

SQUARING SHAFTS



DOVETAILING



VERTICAL CUTS
(Work in Vise)

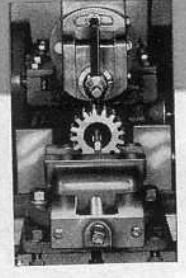

KEYSEATING

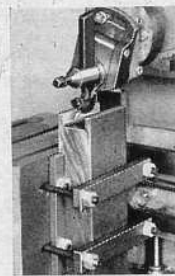

VERTICAL CUTS
(Work Bolted to
Table Side)

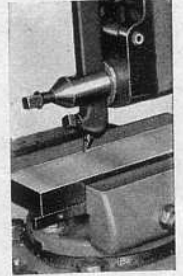

HORIZONTAL CUTS
(Work in Vise)

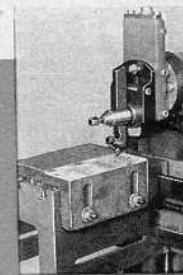

HORIZONTAL CUTS
(Work Bolted to
Table Side)

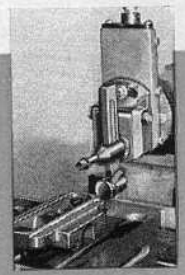

HORIZONTAL CUTS
(Work Bolted to
Table Top)

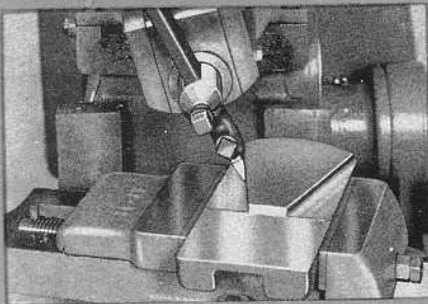

ANGULAR CUTS

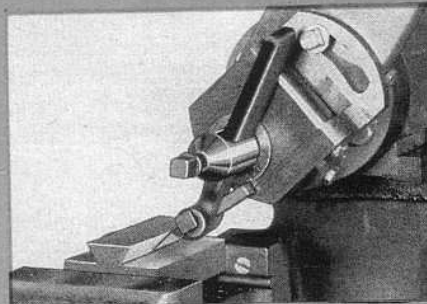

DOVETAILING

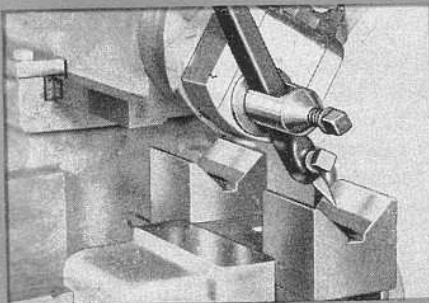

V-CUTS

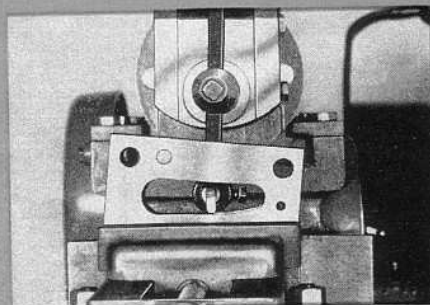

INTERNAL WORK

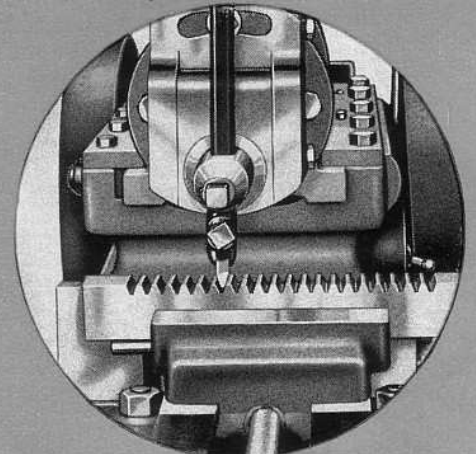

CUTTING RACK TEETH

Atlas

7-INCH SHAPER

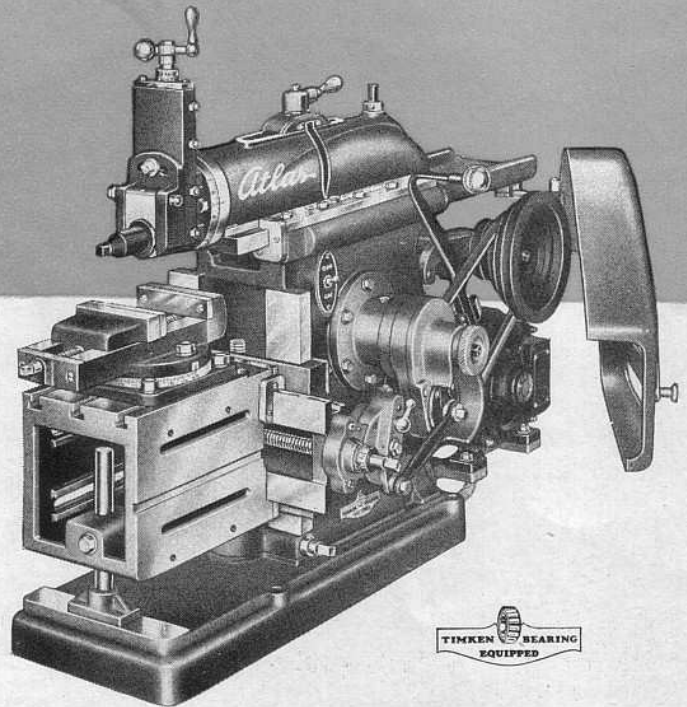
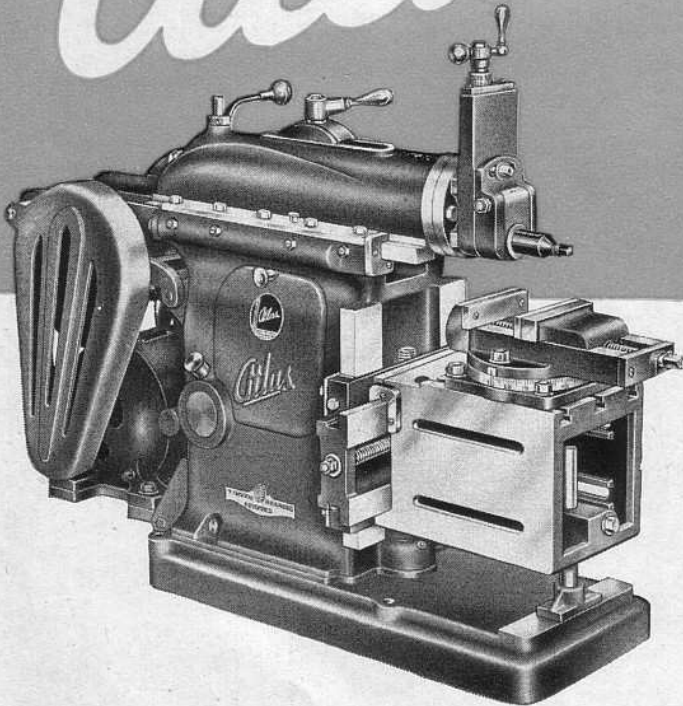

The Atlas Shaper incorporates the fundamental requirements of modern shaper design and construction — rigidity, accuracy, and power — and includes many features which insure working efficiency and ease of operation. The following description explains construction features.

Notice that bearing surfaces are unusually large with full provision for thorough lubrication and complete adjustment, and that carefully selected bearings are provided for all shafts. These fine bearings mean efficient, accurate performance, and long service life.

RIGIDITY To provide rigidity, the first shaper fundamental, heavy semi-steel iron castings are used for column, base, ram, tool head, cross rail, table and vise. Each part is designed with adequate bracing, proper weight distribution and extremely large bearing surfaces. This construction gives the Atlas shaper the rigidity and strength essential for durability and smooth performance.

ACCURACY The accuracy of the Atlas shaper is the result of modern Atlas methods of machining, assembling, and testing. Each part is machined on precision equipment of the latest design. Jigs and fixtures hold the part in exact position during machining, and each operation is inspected for uniformity and accuracy with precision tools and master gauges.

The ram bearing surfaces on the column guides and the cross rail ways bearing on the table are precision-ground and hand-fitted. The unusually large dimensions of these bearings plus provision for thorough lubrication serve to minimize wear. To maintain accuracy and rigidity these bearings have adjustable gibs, and bearing plates have shims with four .002" and two .001" laminations.

Careful inspection at every stage of assembly and thorough working tests of the completed shaper assure accuracy in handling the full range of shaper work.

POWER The crank-type ram-driving mechanism, powered completely by V-belts from motor to bull gear pinion shaft, transmits maximum power to the ram with a smooth even action at all speeds. All shafts are provided with heavy duty bearings. This modern design permits use of a 1/2 HP motor with resultant savings in operating costs.

EASE OF OPERATION The adjustable countershaft, attached directly to the column within easy reach, saves time in selecting and changing speeds. Four speeds are available . . . 45-78-122-186 strokes per minute. The combination belt tension lever and brake permits stopping the ram without stopping the motor.

The stroke-length adjusting mechanism is operated easily with the hand crank and set with a grip-lock. The stroke-positioning control is conveniently located at the top of the ram. Length of stroke in inches is shown by an indicator on a graduated index plate. Direction of the automatic cross feed is shifted with a toggle pawl — five feeds between .005" and .025" per stroke are available in either direction. The crank handle furnished operates all controls.

CONSTRUCTION FEATURES

COLUMN

The massive box-type column of the Atlas shaper is heavily ribbed and braced. Cross rail ways and guides for ram ways are cast integral with column. Heavy base casting is ribbed and reinforced, has ground bearing for table support unit. Cross rail ways are precision ground. Bearing bosses for bull-gear pinion and crank-lever link shafts are bored and line-reamed. The panel in right side of column makes the ram driving mechanism easily accessible for lubrication. Wipers at the front of column keep ram ways clean at all times.

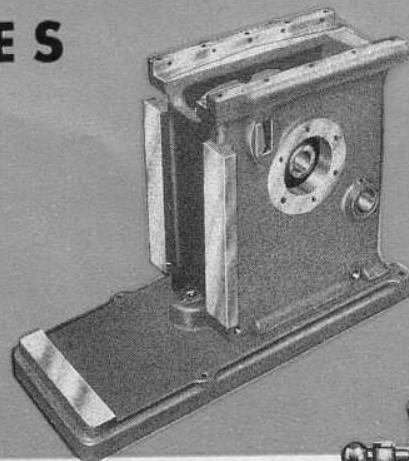

RAM

The streamlined ram is unusually heavy. Ram ways are wide and thick, bearing on tops, sides, and bottoms of guides. Ways are precision ground and hand-fitted. Oil grooves in column guides form a reservoir assuring thorough lubrication of the ram ways—an oil pan is provided to catch drippings. The length of stroke in inches is shown by an indicator on a graduated plate. Stroke-positioning control at top of ram operates screw through two mitre gears—a thrust collar provides full take-up. Lock handle and clamp secure ram to crank-lever yoke.

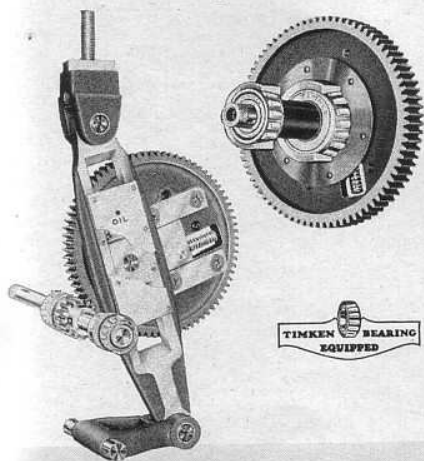
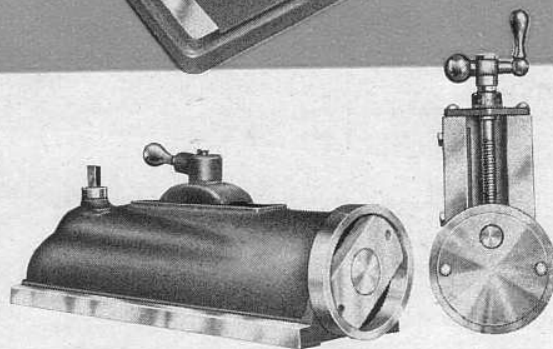

RAM DRIVING MECHANISM

Leverage design assures maximum power. The bull-gear is semi-steel iron with 10 pitch teeth and 1-inch face. Crank arm is special nickel-chrome-vanadium alloy steel, parallel-ground on outer surfaces and milled and lapped on inner "slide." Crank pins run on oilite bronze bearings. Block is wear-resisting super-oilite.

Bull-gear is supported by two heavy-duty Timken tapered roller bearings, one housed in the cast iron flange adjacent to the bull-gear and the other at outer end of bull-gear sleeve. These fine bearings take extremely heavy radial loads and absorb all end thrust.

The large housing for the bull-gear spindle is accurately machined—six large cap screws hold it securely to column. Bull-gear pinion shaft runs on Timken tapered roller bearings. Crank-lever link shaft has oilite bronze bearing.

COUNTERSHAFT. Adjustable V-belt countershaft and motor base are attached directly to column, making the Atlas shaper a single compact unit. Countershaft bracket is slotted for belt stretch adjustment. Hardened, ground countershaft spindle turns on roller bearings.

An extra V-drum on countershaft spindle and a brake shoe at end of adjusting lever convert this lever into a brake that stops the ram without stopping the motor. Belts and pulleys have modern safety guards. Pulleys are balanced.

V-BELT DRIVE. Complete V-belt drive from motor to pinion shaft. 4-step countershaft and pinion-shaft pulleys provide four speeds . . . 45, 78, 122, 186 strokes per minute.

STROKE-LENGTH ADJUSTMENT. Hand crank controls the tobin bronze 45° helical gears operating stroke-adjusting screw (Acme thread). A tobin bronze nut on this screw adjusts position of crank throw-block. Grip-lock sets the mechanism.

TOOL HEAD. Tool head is locked rigidly to accurately machined ram head. Base of tool post is graduated 0 to 50° both ways. Tool post slide has dovetail ways with full gib adjustment. Vertical feed screw has Acme threads, ball crank control, and micrometer-graduated collar with take-up adjustment. Clapper head can be swivelled both ways to provide proper tool clearance—tapered mounting pin simplifies take-up for wear.

CROSS RAIL. Large cross-rail way guides bearing on column are accurately machined and hand-fitted. Ways bearing on table are precision ground and hand-fitted. Both bearing surfaces have gibs and laminated shims for full take-up adjustment.

TABLE AND VISE. Box-type table is supported rigidly by the large cross rail ways and a brace at outer end. Brace can be adjusted and locked securely to support table at any height—a ground "runner pad" on the base provides a smooth bearing surface when table is fed horizontally. Table has three T-slots in its top for the vise or work, a keyway on right side for aligning vise and two slots in each side for bolting work. Top of table is given its final finish cut by shaper itself—table sides are precision ground. Table elevating screw, operated by crank control, has Acme thread, tobin bronze helical gears, and tobin bronze nut. Two wipers, one at each side of table, clean and lubricate ways.

Base of vise is machined for accurate alignment with ram ways—has key for center T-slot in top and keyway in side of table. Vise can be swivelled and locked at any angle and is graduated 0 to 90° both ways. Jaws have steel insert plates. Screw has Acme threads, tobin bronze nut, and take-up adjustment. Vise is furnished as standard equipment.

AUTOMATIC CROSS FEED. The automatic cross feed is engaged by a toggle pawl controlling a fully enclosed steel ratchet gear. Five feeds are available in either direction: .005, .010, .015, .020, and .025 inches per stroke. Complete cross feed mechanism consists of a feed gear on the bull-gear spindle, a slotted gear for adjusting feed per stroke, and a ratchet gear connected to cross slide feed gear by two pitman rods. Feed screw has Acme threads, micrometer graduated collar, and runs on oilite bearings.

The Atlas shaper is designed to be run from a 1/2 HP 1725 RPM motor. (Page 32)

The Atlas

7 INCH SHAPER

COMPLETE SPECIFICATIONS

Length of Ram Stroke..... $\frac{1}{2}$ " to 7"
 Strokes per Minute.....45-78-122-186
 Cutting Speeds, Feet per Minute..... $3\frac{1}{2}$ to 116
 Table Travel..... $9\frac{3}{8}$ " horizontal, 5" vertical
 Maximum Distance Table to Ram..... $5\frac{1}{2}$ "
 Minimum Distance Table to Ram..... $\frac{1}{2}$ "
 Overall Dimensions.....17" x 36" x 26" high

RAM Length, less Tool Head.....17"
 Bearing in Column, total length.....24"
 Bearing in Column, total width..... $3\frac{3}{4}$ "
 Position Range.....4"

TOOL HEAD Diameter.....4"
 Length Feed.....3"
 Tool Post..... $7/16$ " x $1\frac{1}{8}$ " slot to take $3/8$ " tool bits
 or holder for $1/4$ " tool bits, page 32.
 Graduated 0 to 50° right and left—Collar
 graduated in .001ths—Swivel Clapper.

V-BELT DRIVE UNIT Gear Ratio..... $5\frac{1}{3}$ to 1—1" Face
 Pinion Shaft and Countershaft Pulleys.....4-step, V-type
 Switch Built in Column.....15 ampere at 110 volts
 Switch is for single-phase current only—3-phase
 current requires No. S7-300 switch, see page 32.

CROSS FEED Reversible—Power and Hand.
 Feeds Available, Both Directions......005, .010, .015,
 .020, .025 inches per stroke
 Crank Slot Adjustment for Setting Feeds.

CROSS RAIL Table Bearing, total length.....12"
 Table Bearing, total width..... $4\frac{1}{2}$ "
 Bearing on Column, total length.....12"
 Bearing on Column, total width.....6"

TABLE Travel..... $9\frac{3}{8}$ " horizontal, 5" vertical
 Overall Dimensions..... $8\frac{3}{4}$ " x 6" x 6" deep
 Finished Surface, length.....7"
 3 T-Slots on Top..... $3/8$ " x $5/8$ " x 7"
 2 Clamping Slots on each side..... $13/32$ " x $5\frac{1}{2}$ "

WISE Jaw.....4" x $7/8$ "; opens 4"
 Screw Diameter..... $\frac{1}{2}$ "
 Swivel Base Graduated 0 to 90° Right and Left.

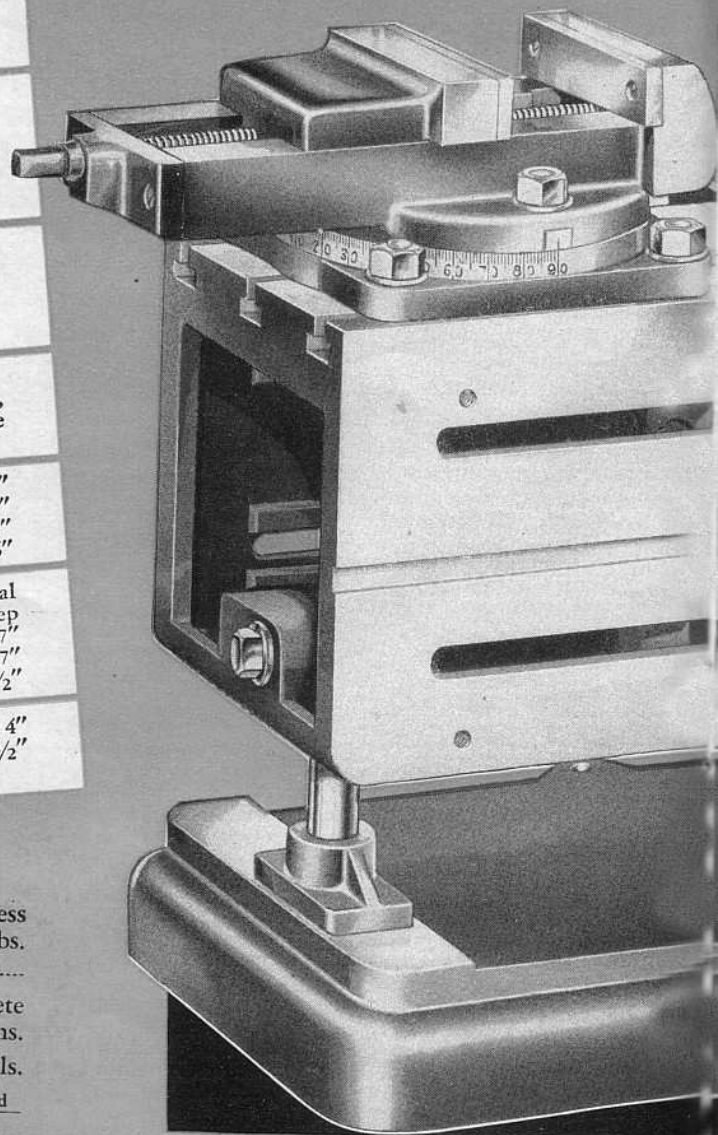
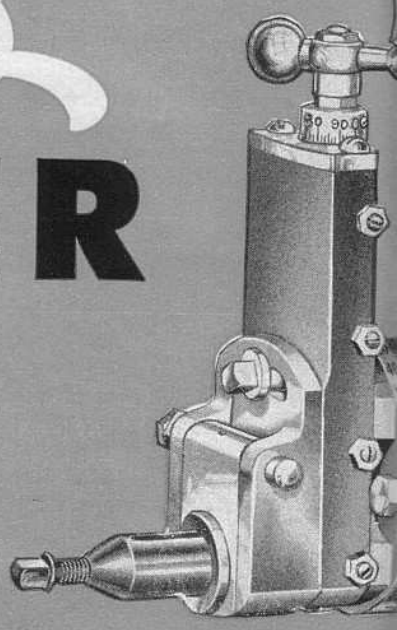

No. 7B ATLAS SHAPER Complete with Safety Guards less
 Motor. Shipping weight 345 lbs. Net weight 270 lbs.
 Code word ZEIBT.....

FURNISHED with Atlas Shaper: Vise, Countershaft, Complete
 V-belt Drive, Crank Handle, Wrenches, Operating Instructions.

MOTORS recommended are listed below. See page 32 for details.

No.	Phase	R.P.M.	H.P.	Volt	Wt.	Code Word
2530A	single	1725	$\frac{1}{2}$	110/220	40	WYZIC
2620	three	1725	$\frac{1}{2}$	220	35	ZEWRO
2625	three	1725	$\frac{1}{2}$	440	35	ZEWUS

**7 inch Stroke • 4 Speeds • 5 Automatic Cross Feeds
Complete V-Belt Drive • Crank Type Ram Drive**

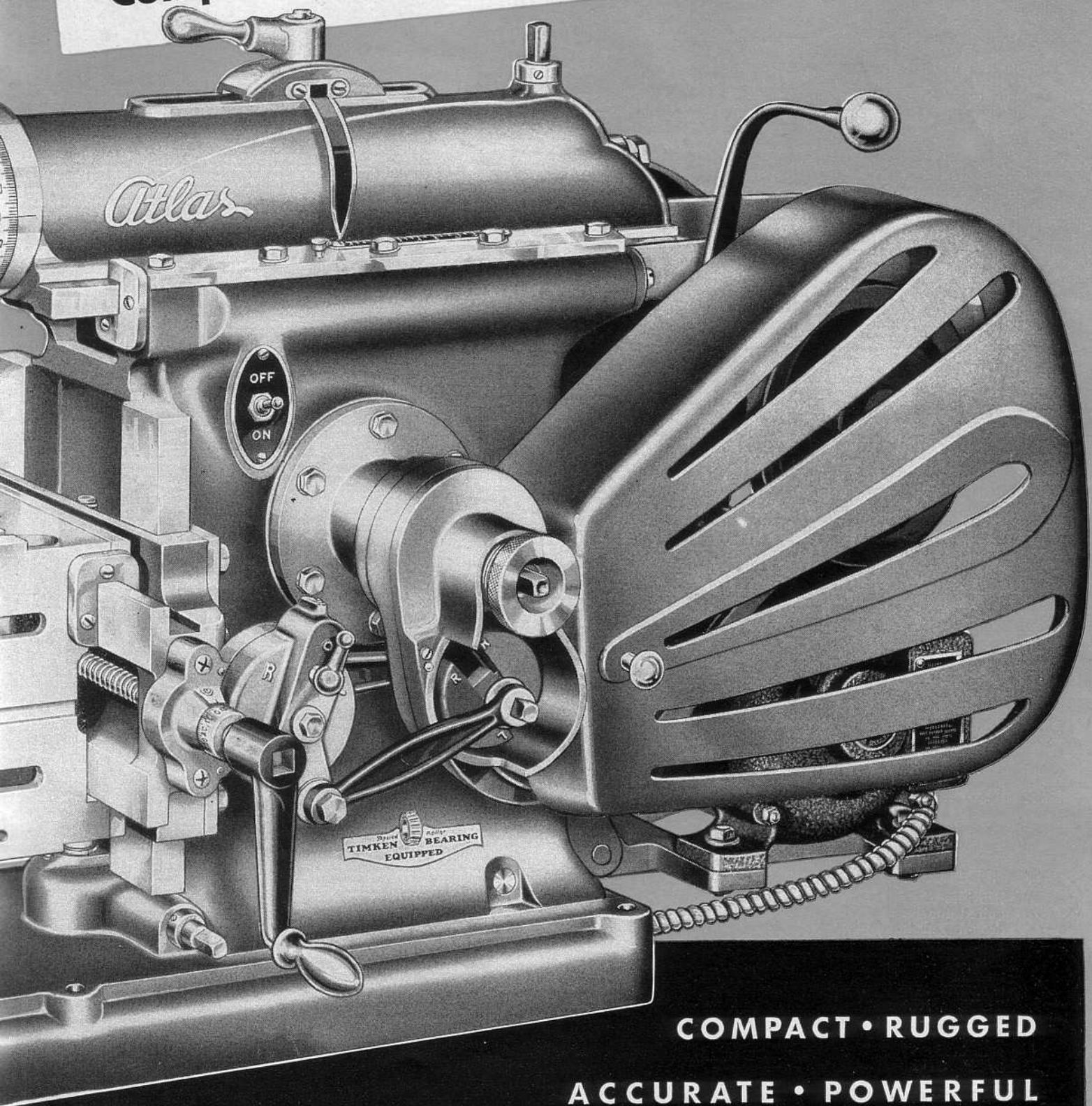

**COMPACT • RUGGED
ACCURATE • POWERFUL**

SHAPER ATTACHMENTS AND ACCESSORIES

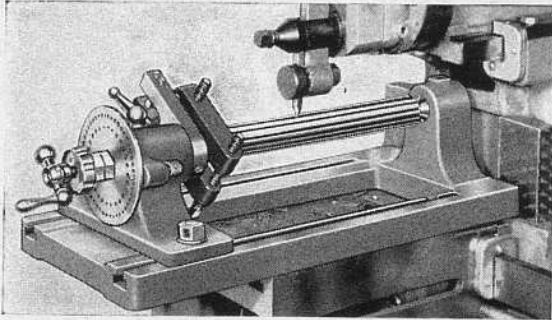

ROTARY INDEX TABLE

(Below) For quick, accurate spacing and dividing operations. Table is precision ground, has three T-slots for positioning and locking work—can be locked at any angle. Holes in side permit indexing the table every 30°. The swivel base is graduated 0 to 90° left and right.

No. S7-420 ROTARY INDEX TABLE for Atlas shaper, with four base-clamping bolts and wrench. Code word ZEHOC, wt. 14 lbs.

Table Diameter.....5 1/2"
Height to Top of Table.....1 7/8"

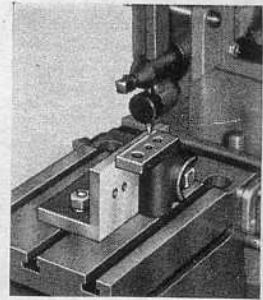

INDEX CENTERS

For dividing operations required in splining, fluting, gear cutting, squaring shafts. Heavy base casting is held to T-slots in shaper table by cap screws. Support for inner center is cast with base—outer center support may be positioned for work up to 8 inches long. Adjustable center is operated by screw with ball crank. Two index plates are furnished, each with two circles of indexing holes engaged by a lock pin through the center support.

No. S7-400 INDEX CENTERS for Atlas shaper. Code word ZEHIB, wt. 21 pounds.

Maximum distance between centers.....8"
Maximum swing.....5 1/2"
Base dimensions.....14 1/4" x 6" x 7/8" thick

FURNISHED: Two index plates (30 and 36 holes, 28 and 48 holes); 1 3/4" clamp dog, dog driver, bolts.

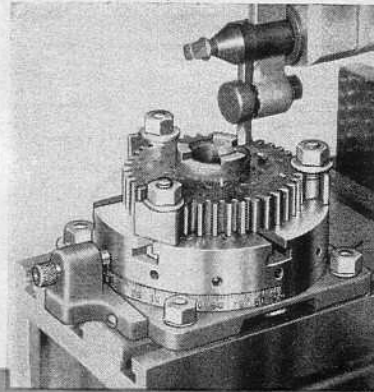

ANGLE PLATE

A solid well-braced iron casting, precision ground on outer faces. Has four holes for bolting work. Two holes for bolting to table T-slots. Base and face each measure 2 1/2" x 4" x 7/16".

No. S7-430 ANGLE PLATE with bolts. Code ZEHUD, wt. 3 lbs.

MOTORS

The 1/2 HP 1725 RPM motors listed below are recommended for the Atlas shaper.

SINGLE PHASE MOTOR

No. 2530A is a capacitor start motor for single phase current. 1/2 HP 1725 RPM, 110/220 Volt, 60 cycle—has SKF ball bearings, 1/2" single-end shaft, 10 ft. SJ approved cord and plug. Code WYZIC, weight 40 pounds.

THREE PHASE MOTORS

Nos. 2620 and 2625 are designed for three phase current. Both are 1/2 HP 1725 RPM, 60 cycle—have SKF ball bearings, 1/2" single-end shaft, BX connector in terminal box. Do not have switch, cord or plug.

No.	H.P.	Volt	Wt.	Code Word
2620	1/2	220	35 lb.	ZEWRO
2625	1/2	440	35 lb.	ZEWUS

THREE PHASE SWITCH

No. S7-300 thermal overload 3-pole manual starter switch is required for 3-phase circuits. Bracket for bench mounting and flexible cable-covered motor cord furnished.

No. S7-300 THREE PHASE SWITCH. Code ZEBAR. Weight 6 pounds.

For complete data on Atlas motors and control switches see pages 59 and 60.

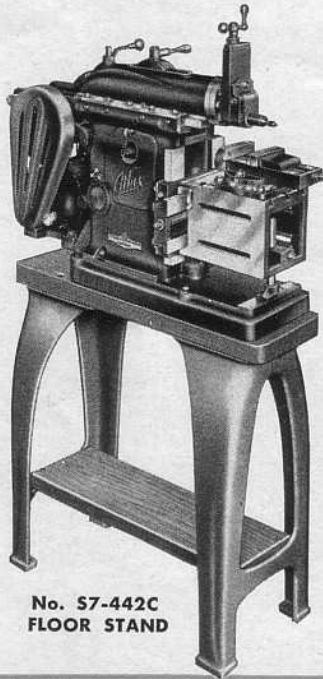

No. S7-442C
FLOOR STAND

FLOOR STAND

The No. S7-442C Floor Stand is a rigid foundation for accurate shaper work. Legs are massive iron castings. Table and shelf are 1 5/8", thoroughly seasoned wood. Overall: 14" x 31" x 33 1/2" high.

No. S7-442C FLOOR STAND for Atlas Shaper. Code word ZEHEZ. Wt. 138 lbs.

FLOOR CABINET

No. M1-750 Floor Cabinet is a rigid shaper support with convenient covered compartments for tools and accessories. Has massive solid-hardwood reinforced construction. Overall height, 31 3/4". Measures 30" x 18" x 1 7/8".

No. M1-750 HARDWOOD FLOOR CABINET for Atlas shaper. Code ZEWEP. Wt. 140 lbs.

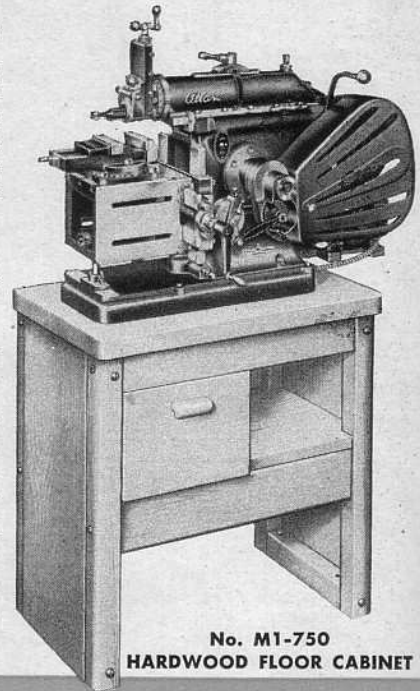

No. M1-750
HARDWOOD FLOOR CABINET

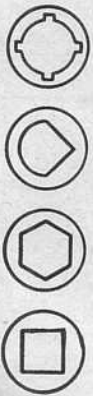

EXTENSION TOOL

Provides extra clearance required for internal work. Has drop-forged holder, 1/2" x 7 1/2" polished steel bar with broached hole for 3/16" high-speed cutter bit.

No. S7-315 EXTENSION TOOL with cutter bit and wrench. Code WYZZA. Wt. 2 lbs.

No. M6-3865 SIX EXTRA 3/16" CUTTER BITS unground. Code word YEZAV, wt. 1 pound.

Cuts Many Shapes

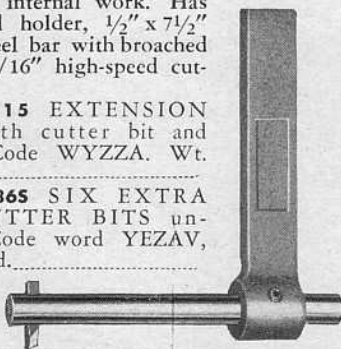

TOOL HOLDER

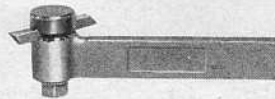

For All Angles

A rigid holder for working at all angles. The head can be swiveled and locked at any one of eight positions. 1/4" high speed cutter bit furnished.

No. S7-139 SHAPER TOOL HOLDER with 1/4" tool bit. Code WYVZO, wt. 2 lbs.

CUTTER BITS



High speed steel 1/4" x 1/4" cutter bits ready-ground for use in S7-139 tool holder.

No. S7-386 SET of 7 FORMED CUTTER BITS shown above. 1/4" x 1/4". ZEDEV, 1 lb. Unground Cutter Bits

No.	Size	No. in set	Wt. (set)	Code
3865	1/4"	6	8 oz.	YARKE
386T	1/4"	12	1 lb.	YARMO
3855	3/8"	6	12 oz.	YARPY

BOOST SMALL PARTS PRODUCTION

Atlas

MILLING MACHINES

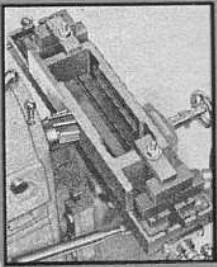

FACING

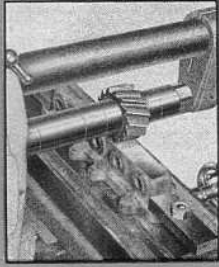

SLABBING

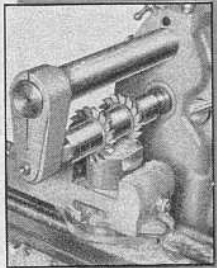

STRADDLE



SLOTING

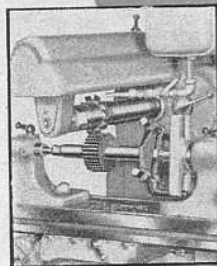

GEAR CUTTING

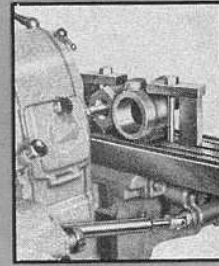

BORING

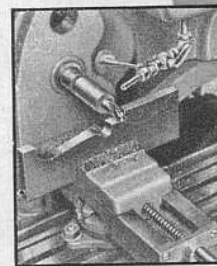

PROFILING

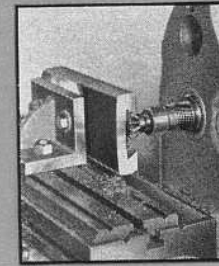

DOVETAILING

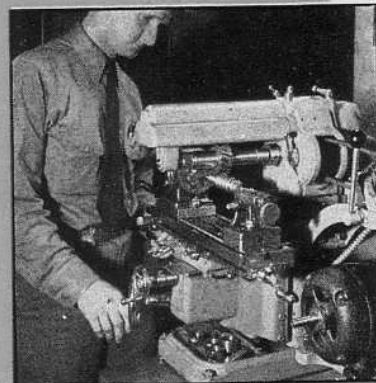

SQUARING

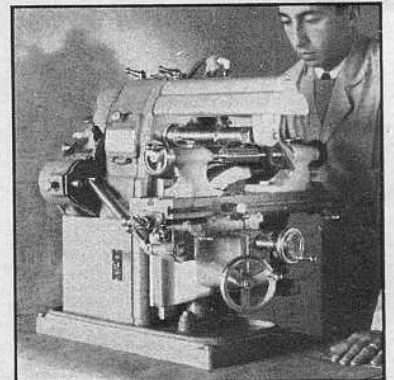

SPLINING

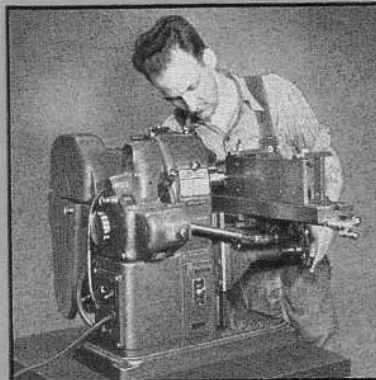

DRILLING — LAYOUT

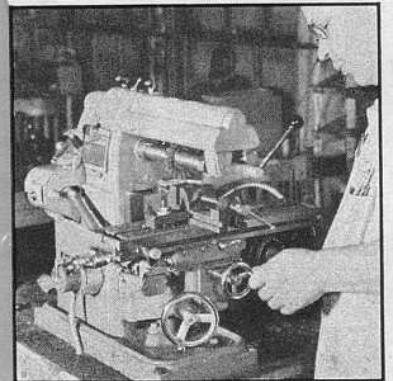

STEP MILLING

THERE are spots for this compact milling machine in every shop and tool room. In thousands of plants, it is boosting production by eliminating the time and effort wasted in setting up and operating a large miller for small parts work.

The Atlas Milling Machine will cut your costs on the full range of milling — it performs all operations with dependable precision. It is rugged, accurate and efficient — economical in investment costs and economical in operation.

Complete details are presented in the following pages.



CONSTRUCTION FEATURES of

THES E descriptions explain how every construction detail of the Atlas Milling Machine has been designed to meet these modern machine tool requirements: *rigidity* and rugged strength essential for the firm support of cutter and work — *accuracy* of construction for accuracy in operation, plus provisions to maintain that accuracy — *power* for heavy cuts, a wide range of spindle speeds for all types of cutters and work — *operating efficiency* to reduce set-up and machining time.

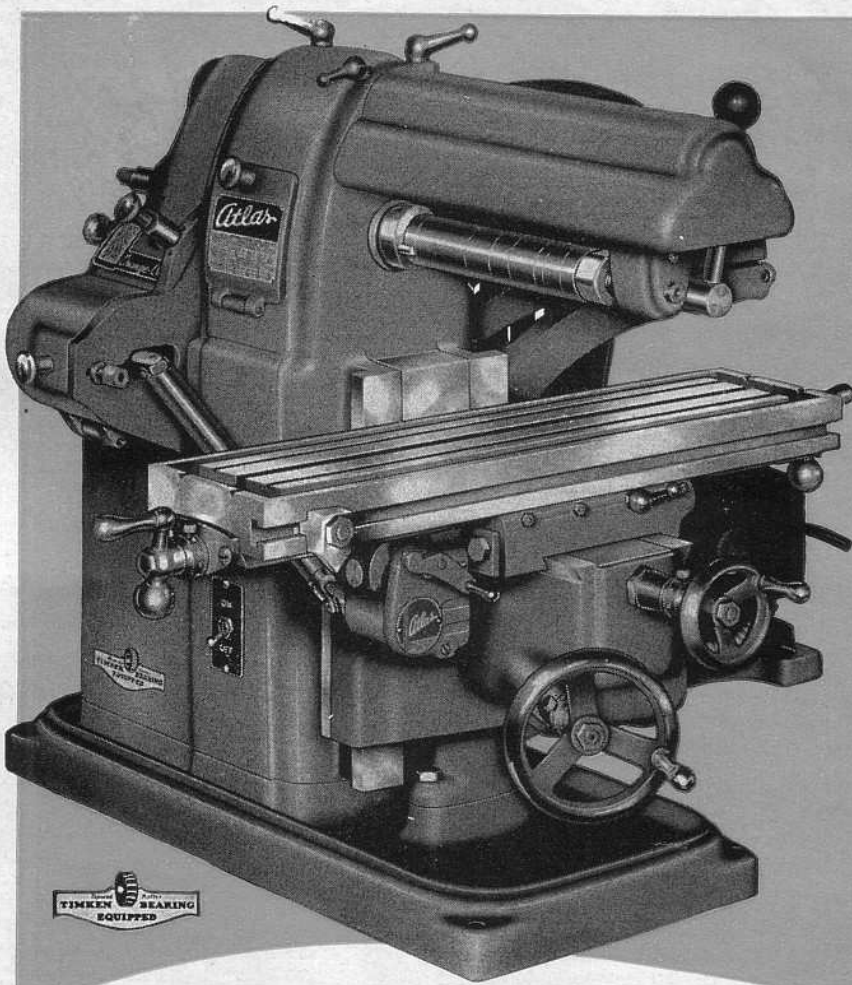

SPINDLE HEAD — A heavy well-braced iron casting anchored rigidly to the column by four large cap screws. Accurate line boring of bearing bosses for spindle bearings, backgear shaft, and overarm insures positive alignment. Spindle head houses the spindle, bearings, pulley and backgears and provides a rugged support for overarm and cutter guard. An iron guard at the rear of the spindle head covers the spindle gear and has an opening for operating the draw-in bar.

COLUMN — A massive thick-walled grey iron casting, ribbed and reinforced to provide a rigid support for spindle head, knee,

and countershaft. Ways for the knee bearings, each $1\frac{1}{2}$ " wide and $\frac{1}{2}$ " thick and cast integrally with the column, are precision ground for smooth, accurate knee and table action. Four large cap screws and two dowel pins hold the column securely to the base casting, a broad and heavy foundation for the entire machine. Front of base is shaped to retain oil, and portion below column forms a reservoir for automatic coolant system (page 42). Column bearing surfaces for base, spindle head, and countershaft are all accurately machined. A single phase on-off switch (10 amperes at 110 volts) is built into the column casting. Three phase switch is listed on page 42.

★ **RIGIDITY** — Heavy semi-steel iron castings are used for the column, base, spindle head, knee, saddle, table, and arbor supports. These castings are scientifically proportioned, rib-braced and reinforced, and have large bearing surfaces. Overarm is a solid bar of stress-proof steel, $1\frac{1}{2}$ " in diameter. The extra weight of all of these parts is the foundation for smooth, accurate cutting action and long service life.

★ **ACCURACY** — The Atlas miller is *entirely precision-machined*. Jigs and fixtures hold each part in exact position during machining, and each operation is inspected for uniformity and accuracy with precision tools and master gauges.

The wide, thick column ways for the knee bearings are precision-ground for smooth, accurate movement of knee and table. Dovetail slides of knee, saddle, and table are accurately machined and hand fitted. Table top and sides are precision ground. Bearing bosses for the spindle bearings, backgear shaft, and overarm are accurately line bored for positive alignment. Precision ground spindle turns on Timken tapered roller bearings. Full provision is made for thorough lubrication of all bearings.

Careful inspection at every stage of assembly and thorough working tests of the completed machine insure accuracy in handling the full range of milling operations.

★ **POWER** — The Atlas backgeared drive, powered completely by V-belts, plus the Timken bearing equipped spindle, transmits maximum power to the cutter with a smooth, even action. This modern design permits the use of an economically operated 1/3 HP motor.

★ **OPERATING EFFICIENCY** — All controls are within easy reach. Eight spindle speeds between 62 and 2870 RPM provide correct surface speeds for all types of work and cutters. Correct spindle speed is obtained quickly by referring to easy-to-read chart for belt positions. Turning a socket-head screw releases arbor support for changing cutters, and the overarm can be easily removed when mounting cutter on spindle. A convenient 10 ampere 110 volt on-off switch is built into the column.

Three types of table controls are available: hand-operated screw feed (page 38), rapid-production lever feed (page 39), and the Atlas "Change-O-Matic" for instant selection of reversible automatic longitudinal table feeds between 0.186" and 11.250" per minute (see pages 36 and 37).



View of column and spindle head showing elevation screw for knee and table.

the Atlas MILLING MACHINES

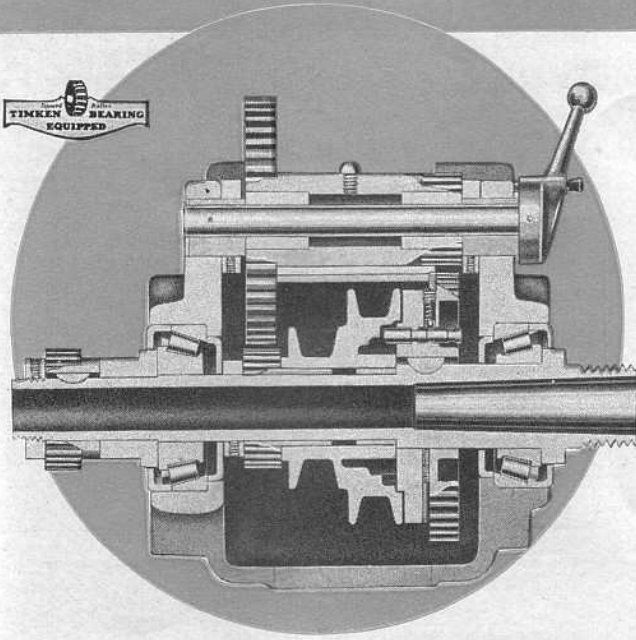

SPINDLE AND BEARINGS — The spindle is machined from a solid bar of special fine-grained steel, accurately ground. It is 1" diameter, has 10-pitch National Form threads and 17/32" hole through entire length. Spindle nose is bored for No. 2 Morse taper.

Timken tapered roller bearings maintain accurate spindle alignment and carry both radial and thrust loads with a minimum of friction. Each bearing is lubricated through a large capped felt-wick oil cup. Simple take-up adjustment is provided. These fine bearings permit the wide range of spindle and surface speeds essential for all types of work and cutters.

BACKGEARED POWER — The Atlas backgeared drive, powered completely by V-belts, reduces the spindle speed for slabbing and facing, and work requiring large diameter cutters. The back gears, completely housed by the spindle head, are engaged by advancing eccentric lever and shifting pulley lock pin. Pulley and gears are accessible through a door in the left side of the spindle head. Backgears are 3/8" wide, 20 pitch, and have ratio of about 6 1/2 to 1. Backgear shaft turns on oilite bronze bearings.

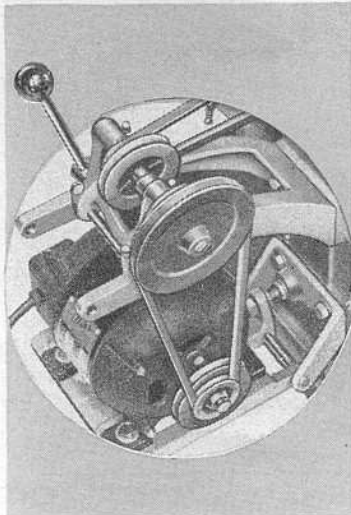

Side view of Atlas milling machine showing V-belt countershaft attached to column. Two-step pulleys from motor to countershaft and two-step pulleys from countershaft to spindle. Notice convenient position of the countershaft lever.

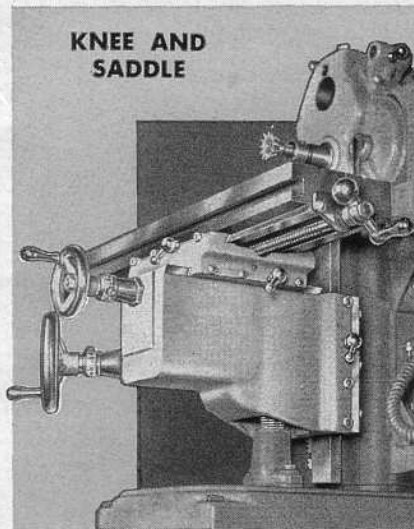

KNEE AND SADDLE

The heavy knee casting travels vertically on the ground column ways and is supported rigidly by full 5 1/2"-long bearings on the ways and by the telescoping elevation screw. Top of knee has an accurately machined dovetail for the saddle. Column bearing plate with laminated shims and an adjustable gib maintain a firm fit between knee and column ways — gib screws have lock nuts. Gib lock permits setting knee rigidly at any height.

The thick heavy saddle casting has dovetail bearings 5" long on the knee and 6" long on the table — forms a rigid table support. Dovetail ways are accurately machined and carefully fitted for smooth table travel. Bearings are equipped with adjustable gibs — gib screws have lock nuts. Gib lock permits setting saddle securely at any point on knee.

The overarm is a solid bar of stress-proof steel, 1 1/2" in diameter — a rugged brace for the arbor support at its outer end. It insures accurate work by maintaining the rigid horizontal position of the arbor and cutters. Bearing bosses for the overarm, on each end of the spindle head casting, are accurately line bored for positive alignment with the spindle. Two coordinate-type clamps lock the overarm rigidly in the spindle head. Arbor is described on page 40.

The grey iron arbor support has a split compression-type bearing which clamps tightly to the overarm — socket-head screw releases bearing for changing cutters. Arbor bearing is oilite bronze, lubricated through a ball oiler. Overarm, arbor support, and arbor are covered by an iron safety guard. Overarm and guard can be removed easily.



OVERARM AND ARBOR SUPPORT

INTEGRAL V-BELT COUNTERSHAFT — Support brackets for the countershaft and motor base are attached directly to the column, making the Atlas milling machine a compact, self-contained unit. Countershaft is "quick-change" type with belt tension lever in easy reach for speed changes. Lever has two positions — forward to release belts, and back to engage them. Countershaft spindle turns on oilite bearings.

The modern V-belt drive from motor to countershaft to spindle transmits maximum power to the spindle with a smooth, even action at all speeds. Eight spindle speeds are available between 62 and 2870 RPM — an easy-to-read chart is furnished listing spindle speeds for the various belt positions (see page 37).

TABLE — The table is a solid grey iron casting 18" long, 4 1/2" wide and 1 3/8" thick — a massive work support with the extra weight essential for maximum rigidity.

All table surfaces are accurately machined, and the top and sides are precision ground. The table top has a T-slot in the center for bolting work and attachments — a V-groove on each side of this T-slot simplifies the firm gripping of bar stock. An adjustable dog-type stop in the front table T-slot can be set to stop longitudinal table travel at any point.

Table dovetail bearing on the saddle is accurately machined and carefully fitted. This bearing is equipped with an adjustable gib — gib screws have lock nuts. A gib lock sets the table rigidly at any point on the saddle. A sloping recess around the table working surface removes oil and cutting compound.

TABLE CONTROLS — The table feed screw for longitudinal travel has a ball crank at each end for hand-feeding the table — screw is supported at each end by an oilite bearing. Vertical travel of the knee and table is controlled by the large front handwheel which operates a telescoping screw with acme threads — ball bearing absorbs end thrust. [Note: MHB Model (page 39) has hand lever controls for rapid movement of table vertically and longitudinally.] Table cross feed screw is controlled by the small handwheel in front — cover keeps screw free from dirt and chips. All table feed screws have acme threads. Steel feed screw collars are micrometer-graduated in .001ths and have a knurled screw which permits setting the 0 position at the witness mark for accurately gauging feed.

Three types of table controls are available: hand-operated screw feed, rapid-production lever feed, and the Atlas "Change-O Matic" for instant selection of reversible automatic longitudinal table feeds between 0.186" and 11.250" per minute. These controls are described between pages 36 and 39.

MOTOR DATA — Atlas milling machines are designed to be operated from a 1/3 HP 1725 RPM motor (see page 42). Motor bracket support is attached directly to column. On-off switch built into left side of column is 10 amperes at 110 volts, single phase only (3 phase motor and switch, page 42). A flexible conduit is furnished to cover portion of switch-to-motor cord between machine and motor.

MFB *Atlas* MILLING MACHINES with

THE *Change-O-Matic* U. S. Patent 2285743

THE MFB Atlas milling machines are equipped with the Atlas "Change-O-Matic" mechanism for instant selection of reversible automatic table feeds between 0.186" and 11.250" per minute. This modern efficiency feature, exclusive with Atlas, speeds up all operations requiring longitudinal movement of the milling machine table.

The Atlas Change-O-Matic controls are pictured at the right. Four automatic feeds are available for each of five spindle speeds — twenty table feeds in all. The desired feed is selected by simply rotating the large knob at the left end of the milling machine. As this knob is turned, a chart appears through the small window, showing the table feed selected (.003", .006", .0125" or .025" per revolution of spindle) and listing the equivalent in inches per minute for each of five spindle speeds. The table at the right summarizes the data appearing on the four sections of the Atlas Change-O-Matic chart.

Direction of the table feed is reversed instantly by shifting the tumbler lever at the right of the Change-O-Matic chart window. This lever has a neutral position to disengage the power feed, so that table may be fed by hand if desired. A dog in the side T-slot of the table can be set to stop the power feed automatically at any point by tripping a lever on the table feed-gear case. This lever can also be disengaged by hand.

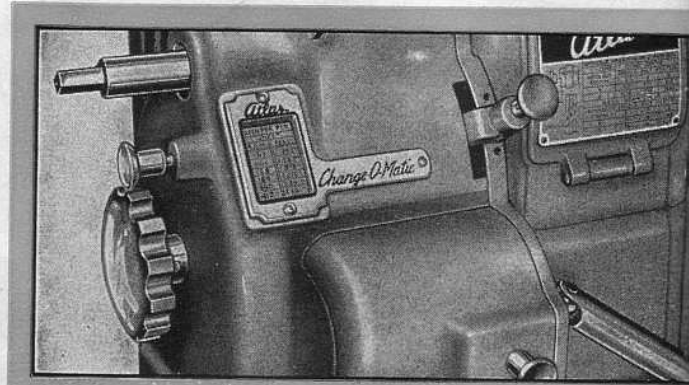

Close-up view of MFB Atlas milling machine showing Change-O-Matic controls. Notice (1) large notched knob and index plunger for selecting feed; (2) chart window showing feed selected; (3) tumbler lever controlling direction of table travel; (4) feed gear case; and (5) portion of telescoping drive bar to the table feed screw.

Change-O-Matic TABLE FEEDS (Inches per Minute)

SPINDLE SPEED R. P. M.	FEED PER REVOLUTION OF SPINDLE			
	.003"	.006"	.0125"	.025"
62	.186"	.372"	.775"	1.550"
130	.390"	.780"	1.625"	3.250"
212	.636"	1.272"	2.650"	5.300"
440	1.320"	2.640"	5.500"	11.000"
450	1.350"	2.700"	5.625"	11.250"

This table summarizes data appearing on the Change-O-Matic chart, listing 20 different table feeds in inches per minute.

COMPLETE DESCRIPTION — PAGES 34-35

COMPLETE SPECIFICATIONS: MFB *Atlas* MILLING MACHINES

FEED RANGE	Longitudinal Table Travel.....	10"
	Reversible Automatic Longitudinal Power Feeds with "Change-O-Matic": Per Revolution of Spindle.....	0.003", .006", .0125", or .025"
	Range.....	0.186" to 11.250" per minute
	Cross Table Travel, Hand-Operated.....	3 1/2"
	Vertical Table Travel, Hand-Operated.....	6"
TABLE	Center of Spindle to Table in Lowest Position.....	6"
	Working Surface, Precision Ground.....	4 1/2" x 18"
	Overall Table Dimensions.....	4 1/2" x 18" x 1 3/8" thick
	T-Slot, Top of Table.....	3/8" x 5/8" x 16"
	T-Slot, Side of Table.....	3/8" x 5/8" x 18"
SPINDLE AND ARBOR	Longitudinal Table Feed Screw.....	1/2" diameter, 10-pitch Acme threads
	Telescoping Table Elevation Screw.....	5/8" and 1" diameter, 10-pitch Acme threads
	Eight Spindle Speeds between.....	62 and 2870 RPM (see chart, page 37)
	Spindle Bearings.....	Timken Tapered Roller Bearings with thrust take-up nut and collar
	Spindle.....	1" diameter, 10-pitch National Form threads, 17/32" hole through entire length, nose bored for No. 2 Morse Taper
V-BELT DRIVE UNIT	Arbor Diameter.....	7/8" or 1" (see page 40)
	Center of Arbor to Underside of Overarm.....	2 1/8"
	Back Gears.....	20-pitch, 3/8" wide
	Backgear Ratio (approximate).....	6 1/2 to 1
	Backgear Shaft Bearings.....	oilite bronze
EQUIPMENT FURNISHED	Countershaft and Spindle Pulleys.....	2-step, V-type
	Countershaft Spindle Bearings.....	oilite bronze
	Motor Recommended.....	1/3 HP 1725 RPM (page 42)
	Overall Dimensions.....	25 1/2" x 32 1/2" x 22" high.

Base Dimensions (Bench Space Required), including motor bracket 20 1/2" x 18 1/2"

EQUIPMENT FURNISHED

Atlas "Change-O-Matic" Controls for Instant Selection of Reversible Automatic Table Feeds; Integral V-belt Countershaft; Belts and Pulleys for Complete V-belt Drive; Motor pulley furnished is for 1/2" diameter motor shaft — prices of pulleys for other motor shafts on request; Motor Mounting Bracket; 10-Ampere Motor Control Switch and Cord with 18" Flexible Conduit Covering — switch is for single phase current only, 3-phase switch is No. S7-300 (page 42); Operating Instructions.

Change-O-Matic TABLE CONTROL

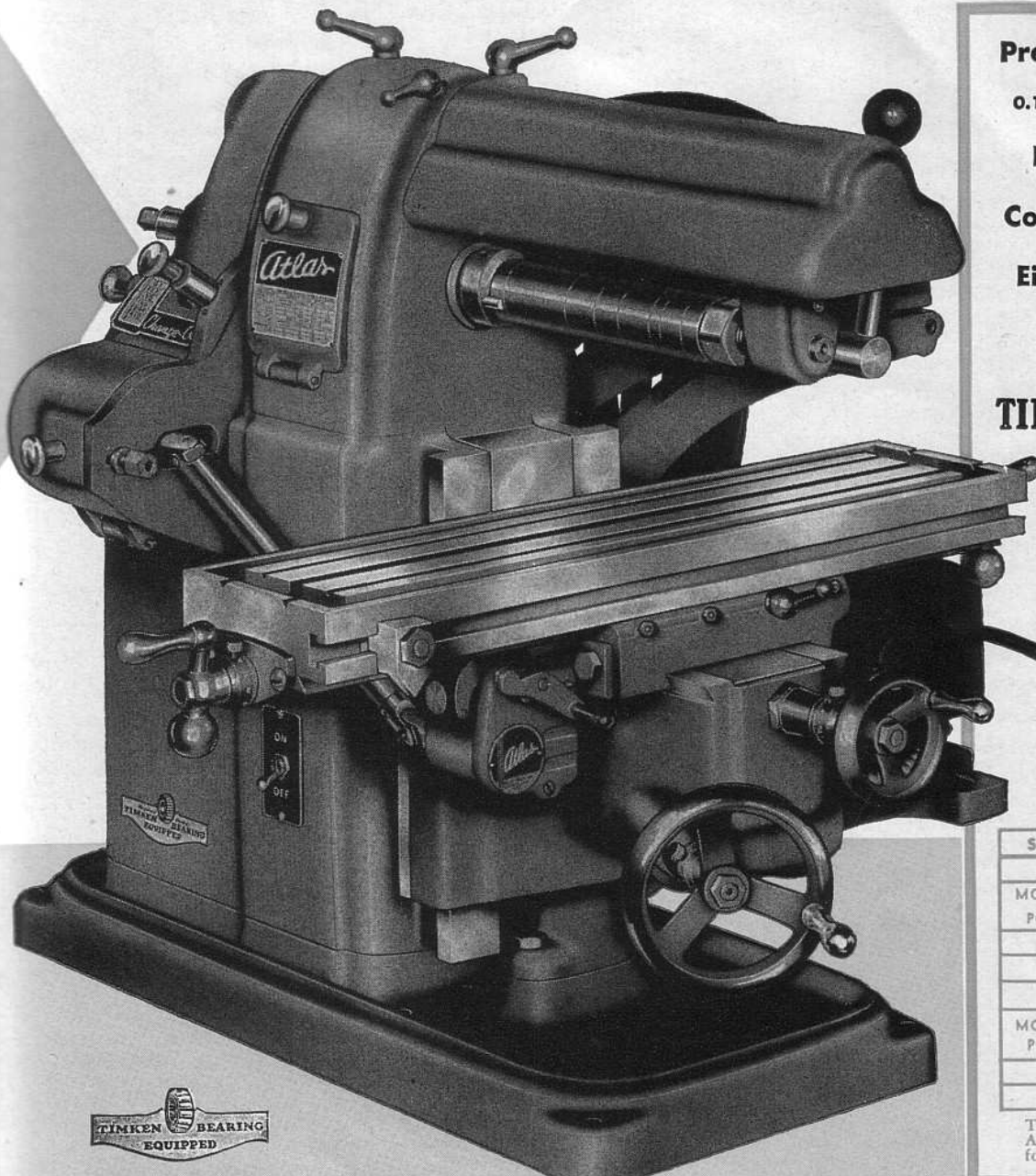

Precision-Ground Table

20 Power Feeds between
0.186" and 11.250" per minute

Backgeared Power

Complete V-Belt Drive

Eight Spindle Speeds
62 to 2870 RPM

EQUIPPED WITH

TIMKEN TAPERED ROLLER BEARINGS

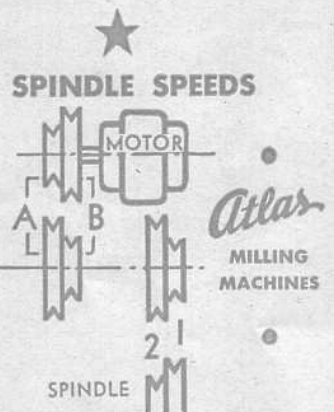

SPINDLE SPEED IN REV. PER MIN.		
DIRECT CONE DRIVE		
MOTOR BELT POSITION	SPINDLE BELT POSITION	
	1	2
A	450	870
B	1400	2870
BACK GEAR DRIVE		
MOTOR BELT POSITION	SPINDLE BELT POSITION	
	1	2
A	62	130
B	212	440

This chart, located on the left side of the Atlas milling machine, shows belt set-ups for eight spindle speeds.



No. MFB ATLAS MILLING MACHINE complete with safety belt guards and Change-O-Matic power feeds, less arbor and motor. Code ZEVSY, net weight 205 pounds, shipping weight 278 pounds.....

CUTTER ARBOR (Page 40)

No. M1-560 CUTTER ARBOR for Atlas milling machine, complete with nut, 6 collars and driver. Code ZETYR. Wt. 5 lb.....
Diam. Arbor.....7/8" Shank.....No. 2 Morse Taper
Diam. Collars. 1 3/8" Length Shoulder to Nut...6 1/4"
Collars furnished: two 2", one 1", one 3/4", one 1/2", one 1/4". (1" diam. cutter arbor is No. M1-560L, page 40.)

No. M1-576 DRAW-IN BAR. Code word ZEVAM, weight 1 1/2 lb.....

No. 57-100 CRANK HANDLE for No. M1-576. Code ZEVYS, wt. 1 1/2 lb.....

MOTORS, THREE PHASE SWITCH (See page 42)

No. 2520B 1/3 HP 1725 RPM SINGLE PHASE CAPACITOR-START BALL BEARING MOTOR. 110/220 volt, 60 cycle, 1/2" single-end shaft, 10 ft. SJ approved cord and plug. Code word ZEWOR, wt. 33 lb.....

No. 2630 1/3 HP 1725 RPM THREE PHASE BALL BEARING MOTOR. 220 volt, 60 cycle, 1/2" single-end shaft, BX connector in terminal box. Does not have switch, cord or plug. Code ZEWPE, wt. 28 lb.....

No. 57-300 THREE PHASE SWITCH for Atlas milling machine. Code word ZEBAR, wt. 6 lb.....

This thermal overload 3-pole manual starter switch is required for 3-phase circuits. Bracket for bench mounting and flexible cable-covered motor cord are furnished.

CUTTERS AND ACCESSORIES - PAGES 40-42

M1B Atlas MILLING MACHINES

Complete
Description
Pages 34-35



WITH HAND-OPERATED TABLE CONTROLS

M1B Atlas milling machines are equipped with hand-operated screw feeds for table movement — (1) large front handwheel operates knee and table vertically, (2) small front handwheel controls cross feed, and (3) ball crank at each end of table permits maximum longitudinal table travel of 12". All feed screw collars are micrometer-graduated in .001ths and have a knurled screw for setting 0 position at the witness mark for accurately gauging feed. An adjustable dog-type stop in the front table T-slot may be set to stop longitudinal table travel at any point. Three gib locks permit secure setting of position of table, saddle and knee (see illustration, page 35). Vertical feed screw of table is lubricated through capped oiler at side of knee.



PRECISION-GROUND TABLE 4 1/2" x 18"

EIGHT SPINDLE SPEEDS 62-2870 RPM

COMPLETE V-BELT DRIVE

BACKGEARED POWER

COMPLETE SPECIFICATIONS

FEED RANGE

Longitudinal Table Travel, Hand-Operated.....	12"
Cross Table Travel, Hand-Operated.....	3 1/2"
Vertical Table Travel, Hand-Operated.....	6"
Center of Spindle to Table in Lowest Position.....	6"

TABLE

Working Surface, Precision Ground.....	4 1/2" x 18"
Overall Table Dimensions.....	4 1/2" x 18" x 1 3/8" thick
T-Slot, Top of Table.....	3/8" x 5/8" x 16"
T-Slot, Side of Table.....	3/8" x 5/8" x 18"
Longitudinal Table Feed Screw.....	1/2" diameter, 10-pitch Acme threads
Telescoping Elevation Screw.....	5/8" and 1" diameter, 10-pitch Acme threads

SPINDLE AND ARBOR

Eight Spindle Speeds.....	62 to 2870 RPM (see chart, page 37)
Spindle Bearings.....	Timken Tapered Roller Bearings with thrust take-up nut and collar
Spindle.....	1" diam., 10-pitch National Form threads, 17/32" hole through entire length, nose bored for No. 2 Morse Taper Arbor Diameter.....
Arbor Diameter.....	7/8" or 1" (see page 40)
Center of Arbor to Underside of Overarm.....	2 1/8"

V-BELT DRIVE UNIT

Back Gears.....	20-pitch, 3/8" wide
Backgear Ratio (approximate).....	6 1/2 to 1
Backgear Shaft Bearings.....	oilite bronze
Countershaft and Spindle Pulleys.....	2-step, V-type
Countershaft Spindle Bearings.....	oilite bronze
Motor Recommended.....	1/3 HP 1725 RPM (page 42)
Overall Dimensions.....	25 1/2" x 32 1/2" x 22" high
Base Dimensions (Bench Space Required), including motor bracket.....	20 1/2" x 18 1/2"

EQUIPMENT FURNISHED: Hand-Operated Table Controls; Integral V-Belt Countershaft; Belts and Pulleys for Complete V-belt Drive; Motor pulley furnished is for 1/2" diameter motor shaft — prices of pulleys for other motor shafts on request; Motor Mounting Bracket; 10-ampere Motor Control Switch and Cord with 18" Flexible Conduit Covering — switch is for single phase current only, 3-phase switch is No. S7-300 (page 42); Operating Instructions,

M1B

ATLAS MILLING MACHINES WITH HAND-OPERATED TABLE CONTROLS

No. M1B ATLAS MILLING MACHINE, complete with safety belt guards and hand-operated table controls, less arbor and motor. Code word ZEVNE, net weight 194 pounds, shipping weight 267 pounds.....

ATTACHMENTS

Complete Details, Pages 40-42

No. M1-560 CUTTER ARBOR for Atlas milling machine, complete with nut, 6 collars and driver. Code word ZETYR. Weight 5 lb.....

Diam. Arbor 7/8". For complete details see page 40. 1" diam. arbor is M1-560L (page 40).

No. M1-576 DRAW-IN BAR. Required to hold cutter arbor in spindle taper. Code ZEVAM, wt. 1 1/2 lb.....

No. S7-100 CRANK HANDLE for No. M1-576. Code ZEVYS. Weight 1 1/2 lb.....

SINGLE PHASE MOTOR

No. 2520B 1/3 HP 1725 RPM SINGLE PHASE CAPACITOR-START BALL BEARING MOTOR. 110/220 volt, 60 cycle, 1/2" single-end shaft, cord and plug. Code ZEWOR, wt. 33 lb.....

THREE PHASE MOTOR

No. 2630 1/3 HP 1725 RPM THREE PHASE BALL BEARING MOTOR. 220 volt, 60 cycle, 1/2" single-end shaft. Code ZEWPE, wt. 28 lb.

No. S7-300 THREE PHASE SWITCH. Code word ZEBAR. Weight 6 lb.....

MHB Atlas MILLING MACHINES

Complete Description, Pages 34-35

WITH RAPID-PRODUCTION LEVER CONTROLS

MHB Atlas milling machines have quick-acting lever controls to speed up longitudinal and vertical table movement for production milling operations. One setting of the lever at the left permits $5\frac{1}{2}$ " longitudinal travel of the table—second lever moves table 2" vertically at one setting.

Each lever operates a rack-and-pinion feed. The lever shafts have squared ends for quick table positioning with crank handle (furnished). Adjustable stops are furnished to set limits of table travel as desired. Dog-type stop in front table T-slot has a set screw for close adjustment of longitudinal travel. A screw anchored securely to the base casting has two sets of lock nuts to set upper and lower limits of vertical table travel. A heavy boss on the miller knee travels between these stops.



PRECISION-GROUND TABLE $4\frac{1}{2}$ " x 18"

EIGHT SPINDLE SPEEDS 62-2870 RPM

COMPLETE V-BELT DRIVE

BACKGEARED POWER



COMPLETE SPECIFICATIONS

FEED RANGE

Maximum Longitudinal Travel, 1 Setting, Lever-Operated..... $5\frac{1}{2}$ "
 Cross Table Travel, Hand-Operated..... $3\frac{1}{2}$ "
 Maximum Vertical Travel, One Setting, Lever-Operated.....2"
 Center of Spindle to Table in Lowest Position.....6"

TABLE

Working Surface, Precision Ground..... $4\frac{1}{2}$ " x 18"
 Overall Table Dimensions..... $4\frac{1}{2}$ " x 18" x $1\frac{3}{8}$ " thick
 T-Slot, Top of Table..... $\frac{3}{8}$ " x $\frac{5}{8}$ " x 16"
 T-Slot, Side of Table..... $\frac{3}{8}$ " x $\frac{5}{8}$ " x 18"
 Longitudinal Table Feed Screw..... $\frac{1}{2}$ " diameter, 10-pitch
 Acme threads
 Telescoping Elevation Screw..... $\frac{5}{8}$ " and 1" diameter, 10-pitch
 Acme threads

SPINDLE AND ARBOR

Eight Spindle Speeds.....62 to 2870 RPM (see chart, page 37)
 Spindle Bearings.....Timken Tapered Roller Bearings
 with thrust take-up nut and collar
 Spindle.....1" diam., 10-pitch National Form threads, $17/32$ " hole
 through entire length, nose bored for No. 2 Morse Taper
 Arbor Diameter..... $\frac{7}{8}$ " or 1" (see page 40)
 Center of Arbor to Underside of Overarm..... $2\frac{1}{8}$ "

V-BELT DRIVE UNIT

Back Gears.....20-pitch, $\frac{3}{8}$ " wide
 Backgear Ratio (approximate)..... $6\frac{1}{2}$ to 1
 Backgear Shaft Bearings.....oilite bronze
 Countershaft and Spindle Pulleys.....2-step, V-type
 Countershaft Spindle Bearings.....oilite bronze
 Motor Recommended.....1/3 HP 1725 RPM (page 42)
 Overall Dimensions..... $25\frac{1}{2}$ " x $32\frac{1}{2}$ " x 22" high
 Base Dimensions (Bench Space Required),
 including motor bracket..... $20\frac{1}{2}$ " x $18\frac{1}{2}$ "

EQUIPMENT FURNISHED: Quick-Acting Lever-Type Table Controls with Crank Handles; Integral V-Belt Countershaft; Belts and Pulleys for Complete V-Belt Drive; Motor pulley furnished is for $\frac{1}{2}$ " diameter motor shaft—prices of pulleys for other motor shafts on request; Motor Mounting Bracket; 10-Ampere Motor Control Switch and Cord with 18" Flexible Conduit Covering—switch is for single phase current only, 3-phase switch is No. S7-300 (page 42); Operating Instructions.

MHB

ATLAS MILLING MACHINES WITH RAPID-PRODUCTION LEVER CONTROLS

No. MHB ATLAS MILLING MACHINE, complete with safety belt guards and rapid-production lever controls, less arbor and motor. Code word ZEVUR, net weight 202 pounds, shipping weight 275 pounds.....

ATTACHMENTS

Complete Details, Pages 40-42

No. M1-560 CUTTER ARBOR for Atlas milling machine, complete with nut, 6 collars and driver. Code word ZETYR. Weight 5 lbs.....

Diam. Arbor $\frac{7}{8}$ ". For complete details see page 40. 1" diam. arbor is M1-560L (page 40).

No. M1-576 DRAW-IN BAR. Required to hold cutter arbor in spindle taper. Code ZEVAM, wt. $1\frac{1}{2}$ lb.....

No. S7-100 CRANK HANDLE for No. M1-576. Code ZEVYS. Weight $1\frac{1}{2}$ lb.....

SINGLE PHASE MOTOR

No. 2520B 1/3 HP 1725 RPM SINGLE PHASE CAPACITOR-START BALL BEARING MOTOR. 110/220 volt, 60 cycle, $\frac{1}{2}$ " single-end shaft, cord and plug. Code ZEWOR, wt. 33 lb.....

THREE PHASE MOTOR

No. 2630 1/3 HP 1725 RPM THREE PHASE BALL BEARING MOTOR. 220 volt, 60 cycle, $\frac{1}{2}$ " single-end shaft. Code ZEWPE, wt. 28 lb.

No. S7-300 THREE PHASE SWITCH. Code word ZEBAR. Weight 6 lb.....

ATTACHMENTS AND ACCESSORIES for

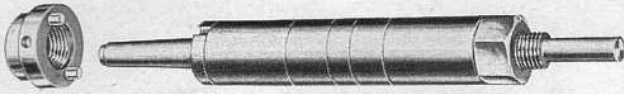

CUTTER ARBORS

Arbors are ground stressproof steel — have full length keyway and No. 2 Morse taper shank for spindle. Driver furnished is threaded for spindle nose. Collars are precision ground. No. M1-576 draw-in bar (right) is required.

Diam. Collars..... $1\frac{3}{8}$ " Shank.....No. 2 Morse taper
Collars Furnished: two 2", one 1", one $\frac{3}{4}$ ", one $\frac{1}{2}$ ", one $\frac{1}{4}$ ".
Length Shoulder to Nut $6\frac{1}{4}$ ".

No. M1-560 CUTTER ARBOR for Atlas milling machine, complete with nut, six collars and driver. $\frac{7}{8}$ " diam. Code ZETYR, wt. 5 lb.

No. M1-560L CUTTER ARBOR for Atlas milling machine, complete with nut, six collars and driver. 1" diam. Code ZEWAN, wt. 6 lb.

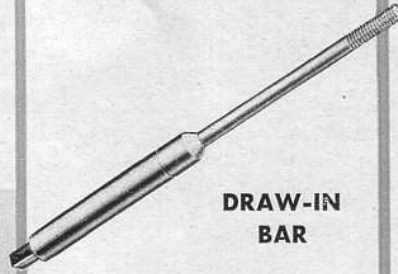

DRAW-IN BAR

Draw-in bar is required to hold M1-560 or M1-560L cutter arbors and M1-577 shank cutter adapter in spindle taper.

No. M1-576 DRAW-IN BAR. Required for cutter arbor and shank cutter adapter. Code word ZEVAM, wt. $1\frac{1}{2}$ lb.



CRANK HANDLE

Crank handle is required for No. M1-576 draw-in bar and No. M1-300 vise (page 41). Drop forged — has accurately broached hole.

No. S7-100 CRANK HANDLE. Code ZEVYS, wt. $1\frac{1}{2}$ lb.

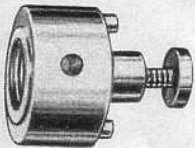

SHELL END MILL DRIVER

Required for No. M1-585 shell end mill. Is threaded for spindle nose and has two driving pins for slot in back of cutter, ground pilot for cutter hole, and large retainer screw.

No. M1-570 SHELL END MILL DRIVER. Code word ZEVMA, wt. 2 lb.



ARBORS FOR ANGULAR CUTTERS

Required for holding No. 574 angular cutters in No. M1-577 shank-cutter adapter. Wt. 8 oz. each.

No.	For No.	Thread	Code
572	574A	24	YEWTE
567	574B	20	YEWUX



SHANK-CUTTER ADAPTER

Holds $\frac{1}{2}$ " straight shank cutters (angular cutters, end mills, Woodruff keyway cutters). Held in milling machine spindle with M1-576 draw-in bar (required).

No. M1-577 SHANK-CUTTER ADAPTER. Code word ZEVEN, wt. 1 lb.



ANGULAR CUTTERS

For face-milling and dovetailing. Threaded hole — adapted to No. M1-577 shank-cutter adapter with arbors listed above. Wt. 6 oz. each.

No.	Thick	Diam.	Hole	Code
574A	$\frac{7}{16}$ "	$1\frac{1}{4}$ "	$\frac{3}{8}$ "	YALIF
574B	$\frac{9}{16}$ "	$1\frac{5}{8}$ "	$\frac{1}{2}$ "	YALJE

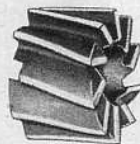

R.H. SPIRAL SHELL END MILL

For wide facing cuts, surfacing, and end milling. Has R.H. spiral teeth. Back is slotted to fit driving pins of M1-570 driver (required). Wt. 2 lb.

No.	Dia.	Thick.	Hole	Code
M1-585	2"	$1\frac{3}{8}$ "	$\frac{3}{4}$ "	ZEVIP



END MILL BUSHINGS

Required to adapt all 576 end mills (except No. 576E) to No. M1-577 shank-cutter adapter. Wt. 4 oz. each.

No. 563E Set of 4 End Mill Bushings. Code YALED.



WOODRUFF KEYWAY CUTTERS

For cutting Woodruff keyways, slots, grooves, T-slots, etc. Straight shank — held directly in No. M1-577 shank-cutter adapter, 6 oz. each.

No.	Diam.	Thick	Code
575A	$\frac{1}{2}$ "	$\frac{1}{8}$ "	YALUH
575B	$\frac{3}{4}$ "	$\frac{3}{16}$ "	YALYJ
575C	$1\frac{1}{8}$ "	$\frac{1}{4}$ "	YAMAD
575D	$1\frac{1}{2}$ "	$\frac{5}{16}$ "	YAMDA
575E	$1\frac{3}{4}$ "	$\frac{3}{8}$ "	YAMEF



R.H. SPIRAL END MILLS

For slots, straight keyways, facing, routing, squaring and splining shafts. Straight shank — held in No. M1-577 shank-cutter adapter with bushings above. Wt. 4 oz. each.

No.	Lgth. Flute.	Diam.	Code
576A	$\frac{5}{8}$ "	$\frac{1}{4}$ "	YAKCE
576B	$1\frac{1}{16}$ "	$\frac{5}{16}$ "	YAKEC
576C	$\frac{3}{4}$ "	$\frac{3}{8}$ "	YAKFO
576D	$\frac{7}{8}$ "	$\frac{7}{16}$ "	YAKID
576E	$1\frac{5}{16}$ "	$\frac{1}{2}$ "	YAKOF



METAL SLITTING SAWS

Sides taper-ground for proper clearance. Held on M1-560 arbor. $\frac{7}{8}$ " hole. Wt. 8 oz. each.

No.	Diam.	Thick.	Code
M1-582	$2\frac{1}{2}$ "	$\frac{1}{32}$ "	ZETOP
M1-583	$2\frac{1}{2}$ "	$\frac{1}{16}$ "	ZETPO
M1-584	$2\frac{1}{2}$ "	$\frac{1}{8}$ "	ZETRY



SIDE MILLING CUTTER

Teeth have cutting edges on three sides. Held on M1-560 arbor.

No. M1-581 $2\frac{1}{2}$ " diam., $\frac{1}{4}$ " face, $\frac{7}{8}$ " hole. Code ZETME, wt. 1 lb.

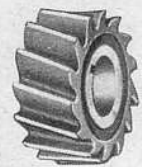

SLAB MILLING CUTTER

For plain surfacing — has R.H. spiral teeth. Held on M1-560 arbor. Hole $\frac{7}{8}$ ". Wt. 2 lb.

No. M1-580 $2\frac{1}{4}$ " diam., 1" face. Code ZETLA.

the *Atlas* MILLING MACHINES

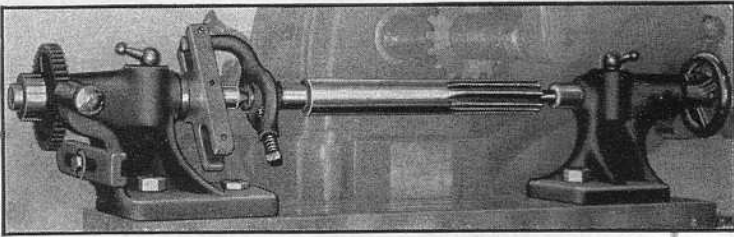

INDEX CENTERS

For dividing operations required in such work as splining, fluting, gear cutting, and squaring shafts. Headstock and tailstock are heavy well-braced castings, locked with bolts to T-slot in milling machine table — both have keys at each end to maintain alignment with table T-slot. Centers may be positioned for work lengths up to 9 inches and locked with coordinate clamps. Headstock spindle nose is threaded for double-end dog driver or chucks listed below — outer end of spindle accommodates index gear and lock nut. Lock pin support bracket is adjustable for various gear diameters. Tailstock center has handwheel control.

No. M1-200 INDEX CENTERS for Atlas milling machine. Code word ZESLE, wt. 15 lb. 9"
 Maximum distance between centers 9"
 Maximum swing 6"
 Headstock spindle nose...1" dia., 10 pitch NF threads
 Headstock spindle nose taper.....No. 2 Morse taper
 Hole through headstock spindle.....17/32"
 Tailstock ram taper.....No. 1 Morse taper

Furnished: Nine indexing gears (36, 40, 44, 46, 48, 52, 54, 56 and 64 teeth); 1 1/2" dog, driver, bolts; two 60° centers — No. 2 Morse taper for headstock, No. 1 Morse taper for tailstock.

NOTE: Chucks threaded to fit the headstock spindle nose of the M1-200 index centers are described below.

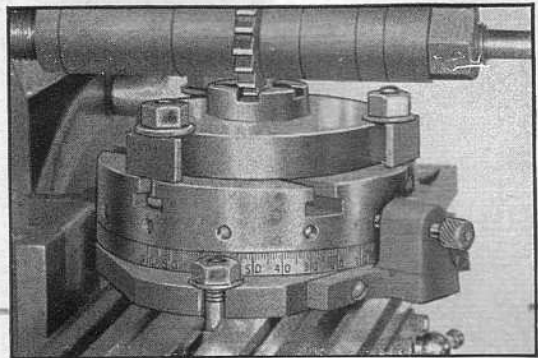

ROTARY INDEX TABLE

The No. M1-350 rotary index table holds pieces for accurate angular indexing and spacing operations. The table is precision ground on all surfaces and can be swiveled to any angle and locked to base with two bolts furnished. There are three T-slots in the top of the table for positioning and locking the work — one T-slot extends through the center of the table, and the other two T-slots are parallel and 2 1/4 inches apart. Holes spaced around the side of the table permit indexing the table rigidly every 30° with plunger and knob. The swivel base is graduated from 0 to 90° left and right.

No. M1-350 ROTARY INDEX TABLE for Atlas milling machines. Furnished with two base-clamping bolts and wrench. Code word ZESNO, weight 15 pounds.

Table Diameter 5 1/2"
 Height to Top of Table 1 7/8"
 Three T-Slots, Top of Table 3/8" x 3/8"

The chucks described below are threaded to fit the spindle of the Atlas milling machines, also the headstock spindle nose of the No. M1-200 index centers (above).

CHUCKS

Special Note: These three chucks also fit the spindle nose of the Atlas six-inch lathes, no adapters required.

JACOBS CHUCK

Accurate and convenient for holding small work. Handles 1/2" shafts through spindle of milling machine or M1-200 index centers. Heat treated steel jaws and body.

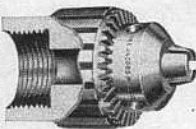

No. M6-375 JACOBS CHUCK capacity 0 to 17/32" complete with key-type wrench. Code word YEEBY, wt. 3 lb.

UNIVERSAL CHUCK

Self centering jaws controlled by turning one screw. High strength semi-steel body, heat treated alloy steel jaws with raised and ground steps. Handles 1/2" rods through spindle of milling machine or M1-200 index centers.

No. U6-437 4" 3-JAW UNIVERSAL CHUCK complete with 2 sets of jaws (inside and outside) and wrench. Code YIAJK, 5 lb.

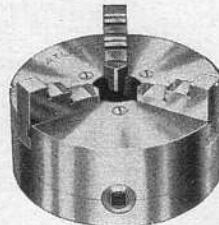

INDEPENDENT CHUCK

One-piece body is high-strength semi-steel casting — face and outer edge are ground. Jaws have raised and ground steps and are reversible. Screws have socket-head for wrench.

No. U6-439 4" INDEPENDENT CHUCK. Wrench furnished. Code YIALM, weight 6 lb.

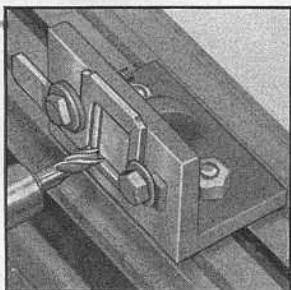
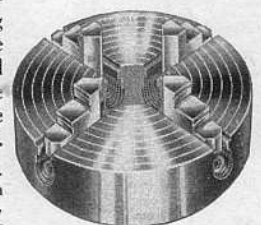

ANGLE PLATE

The angle plate holds irregular shapes which cannot be gripped in the No. M1-300 vise (right) or bolted to the table. It is a solid well-braced iron casting, accurately machined to a right angle and precision ground on the outer faces. Working face has four holes for bolting work. Base has two holes for bolting to T-slot in the miller table. Base and face each measure 2 1/2" x 4" x 7/16".

No. S7-430 ANGLE PLATE with bolts. Code word ZEHUD, weight 3 lb.

SWIVEL VISE

Grips work rigidly at any angle. Vise and base are heavy, accurately machined castings — base has machined bolt slot at each end and 3 1/2" long key in bottom to maintain alignment with T-slot of milling machine table. Vise can be turned in a complete circle and locked in any position — base is graduated from 0 to 90° left and right. Jaws are 3" wide, 7/8" high, open 3 3/8", and have steel insert plates. Acme-thread screw has tobin bronze nut and take-up adjustment. Vise is operated by No. S7-100 crank handle (page 10).

No. M1-300 SWIVEL VISE with clamping bolts. Code ZESON, weight 15 lb.

Overall height with base 3 3/8". Vise may be removed from base and used alone as plain vise.

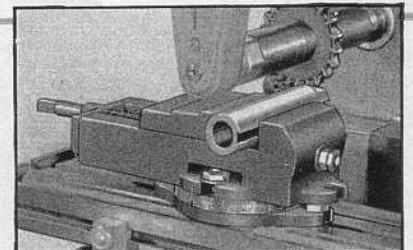

Atlas MILLING MACHINE ACCESSORIES

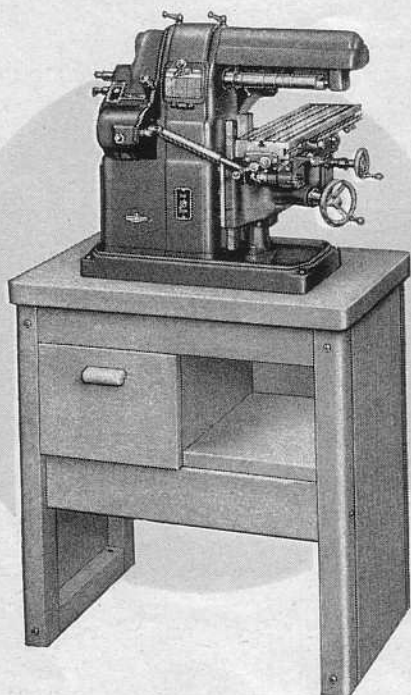

FLOOR CABINET

No. M1-750 hardwood floor cabinet provides the rigid support required for accurate milling work and has convenient covered compartments for tools and accessories. It is patterned after modern heavy-duty scientific laboratory furniture. Massive solid hardwood construction of all principal parts furnishes extra weight and rigidity for smooth, quiet machine operation. All frame joints are glued, screwed and bolt-reinforced. Table measures 30" x 18" x 1 $\frac{5}{8}$ ".

Two roomy cupboards 8 $\frac{1}{4}$ inches high furnish covered space for storage of accessories and tools — the right-hand cupboard is open-front, and the left cupboard is equipped with pull-down door with catch at horizontal position. Door is flush-front type, and the entire cabinet is round-cornered and natural finished for attractive appearance.

SPECIFICATIONS — No. M1-750 HARDWOOD FLOOR CABINET

Order No.	Table Dimensions	Overall Height	Weight	Code Word
M1-750	30" x 18" x 1 $\frac{5}{8}$ "	31 $\frac{3}{4}$ "	140 lb.	ZEWEP

AUTOMATIC COOLANT SYSTEMS FOR ATLAS MILLING MACHINES

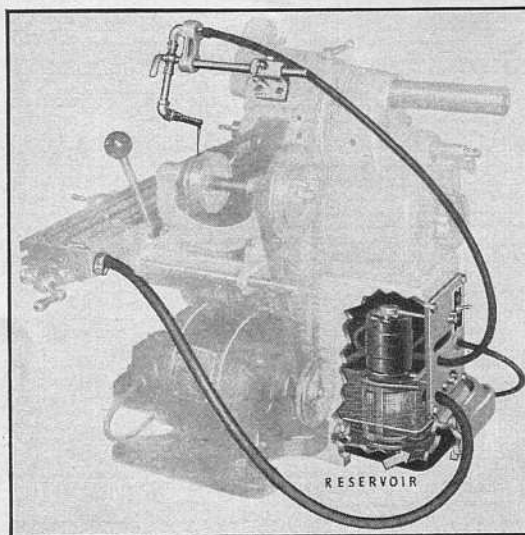

Nos. M1-600A and M1-600B coolant systems meet peak production demands, reduce tool wear, and improve work finish. Designed especially for use with Atlas milling machines — powered by modern centrifugal-type pumps engineered for continuous service with any cutting fluid. Simplicity of construction lengthens service life, and insures smooth, trouble-free performance.

Pump is installed in 3-pint reservoir compartment in base of the Atlas miller — on-off switch is built into cover plate. Extruded plastic feed line has sliding support arm, and the outlet nozzle is adjustable so that the flow of coolant can be directed easily to any point on cutter arbor. No priming is necessary. Control valve regulates flow as desired from slow drip to fast washing action. Extruded plastic return hose has screen filter at table outlet.

MOTORS

The 1/3 HP 1725 RPM motors listed below are recommended for the Atlas milling machines.

SINGLE PHASE MOTOR

No. 2520B is a single phase capacitor start, developing full power instantly under load without drawing excess current.

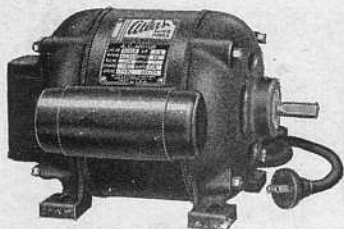

No. 2520B 1/3 HP 1725 RPM SINGLE PHASE CAPACITOR-START BALL BEARING MOTOR, 110/220 volt, 60 cycle, 1/2" single-end shaft, 10 ft. SJ approved cord and plug. Code ZEWOR. Weight 33 lb.

THREE PHASE MOTORS

Nos. 2630 and 2635 are designed for use with three phase current. Both are 1/2 HP 1725 RPM, 60 cycle — have SKF ball bearings, 1/2" single-end shaft. Furnished with BX connector in terminal box — do not have switch, cord or plug.

No.	HP	Volt	Wt.	Code Word
2630	1/3	220	28 lb.	ZEWPE
2635	1/3	440	30 lb.	ZEWYT

THREE PHASE SWITCH

No. S7-300 thermal overload 3-pole manual starter switch is required for 3-phase circuits. Bracket for bench mounting and flexible cable-covered motor cord are furnished.

No. S7-300 THREE PHASE SWITCH. Code word ZEBAR, wt. 6 lb.

PUMPING CAPACITIES

No. M1-600A
No. M1-600B

GALLONS PER HOUR

	Soluble Oil (50% Solution)	Lard Oil (70° F.)
No. M1-600A	198	78
No. M1-600B	360	108

No. M1-600A COOLANT SYSTEM FOR ATLAS MILLING MACHINES complete as shown. Motor: induction, 3450 RPM for 110/120 volt, 50-60 cycle AC. ZEJBE, wt. 12 lb.

No. M1-600B COOLANT SYSTEM FOR ATLAS MILLING MACHINES complete as shown. Motor: universal, 6000 RPM for 110/120 volt AC-DC. ZEKEC, wt. 19 $\frac{1}{2}$ lb.

Other Pump Motors Available — Details on Request.

COOLANT TANK

(Right) A gravity-flow tank of approximately one quart capacity. Sliding support arm and adjustable nozzle permit directing a flow of coolant to any point on the cutter arbor. Valve regulates flow. Nozzle is tipped with oil-proof extruded plastic.

No. M1-550 COOLANT TANK. Code ZETAL, wt. 8 lb.

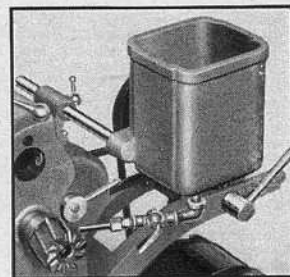

REDUCE DRILLING AND TAPPING COSTS

Atlas

DRILL PRESSES

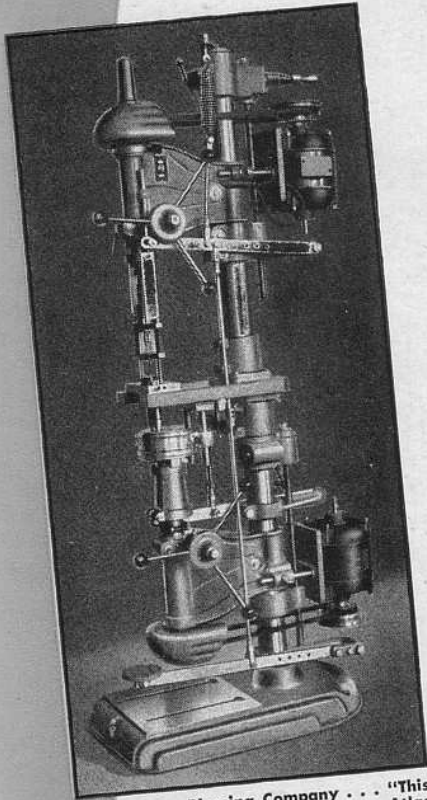

The Bastion-Blessing Company . . . "This drilling machine, built around two Atlas drill press heads and standard column and base, increased production to over 4,000 holes drilled per hour."



Bowers Tool and Die Company . . . "Our Atlas equipped countersinking machine cost us only half the price of a special machine and has increased production 750%."

THE ingenuity and resourcefulness of American engineers, that multiplied the nation's productive capacity during the past few critical years, will perhaps never be fully evaluated. An outstanding achievement has been the adaptation of compact precision bench machines to solve difficult production problems inexpensively.

Atlas drill presses with their unique "floating drive" spindle design have figured importantly in such developments. Adding air chucks, or cut-off switches, or other special production aids, has resulted in amazing speed in handling all kinds of intricate as well as standard operations. Keep in mind the precision and adaptability of Atlas drill presses in thinking about your present and future drilling operations.

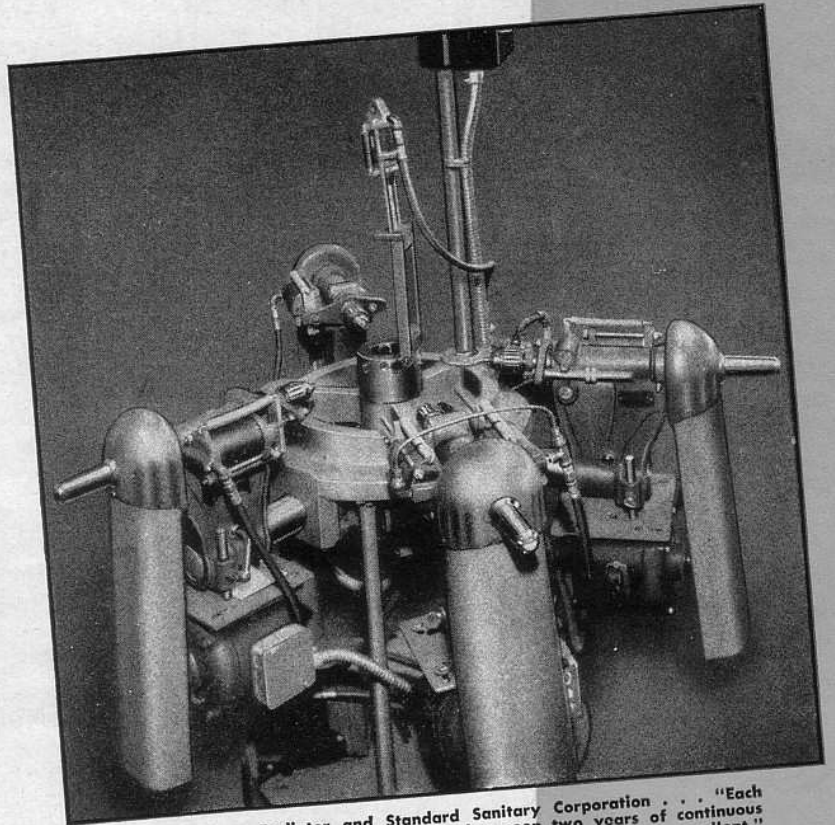

The American Radiator and Standard Sanitary Corporation . . . "Each head in our special drilling machines has seen two years of continuous service and has drilled over a million holes. Performance is excellent."

STEP UP SMALL-HOLE DRILLING

Atlas

ATLAS DRILL PRESSES continue to do two important jobs in thousands of plants. They step up production on the full range of small-hole drilling and tapping operations. And they slash costs . . . both initial machine costs and operating costs.

Battery after battery of these modern high-speed machine tools have proved their durability at peak production — maintained their accuracy after thousands of tough production hours, thanks to rugged and ingenious construction. The pictures on these pages show typical Atlas drill press installations in the plants of some of the world's leading producers.

"Match the machine to the job"—the Atlas idea that puts modern, fast precision tools to work on small-parts production so capacities of larger machines will not be wasted — is playing an increasingly important role in industry. Atlas drill presses have proved themselves ideal multi-purpose tools for this new production strategy. The following pages give you the details of their construction features and specifications.

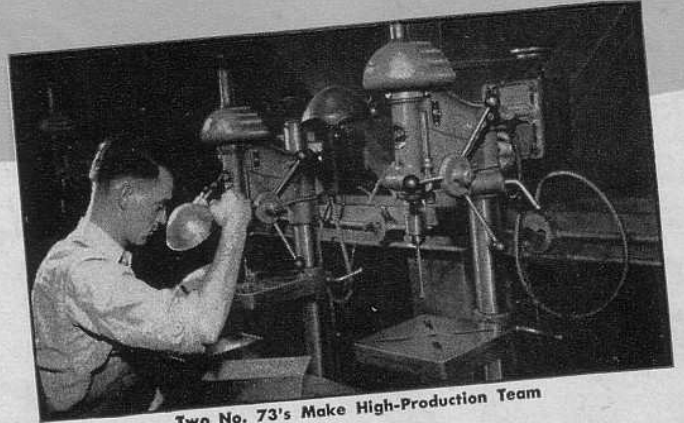

Two No. 73's Make High-Production Team

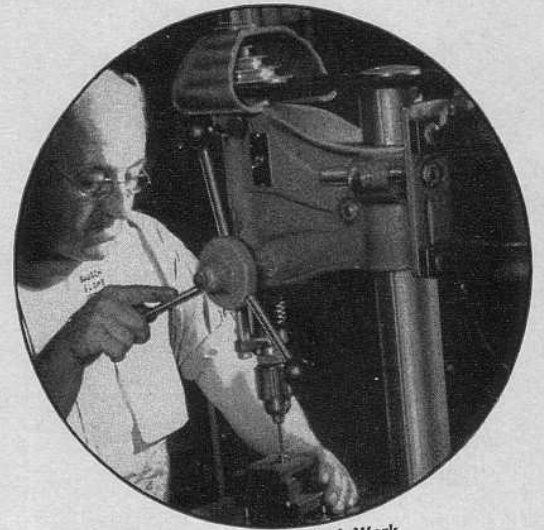

Precision Optical Work

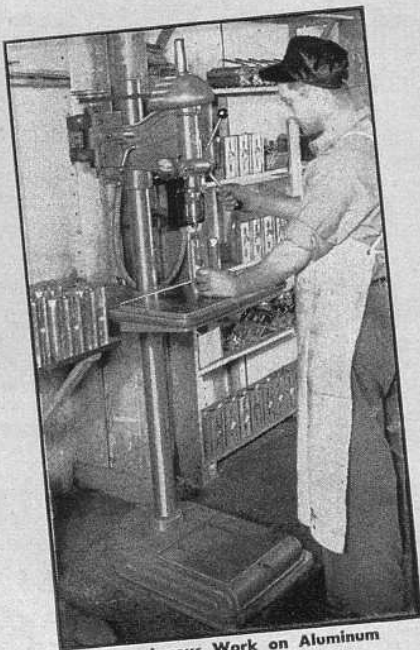

Continuous Work on Aluminum

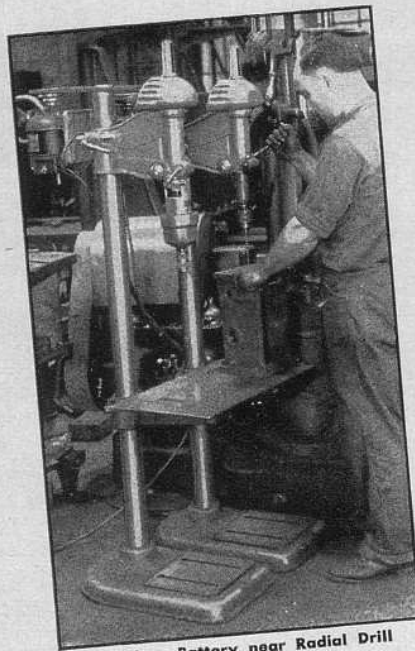

Auxiliary Battery near Radial Drill

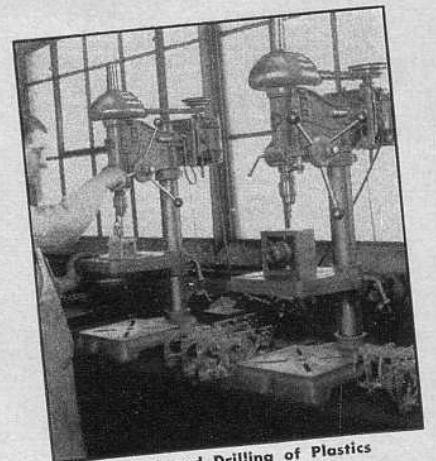

High-Speed Drilling of Plastics

AND TAPPING PRODUCTION WITH

DRILL PRESSES



Battery of Eight No. 63's in Large Aircraft Plant

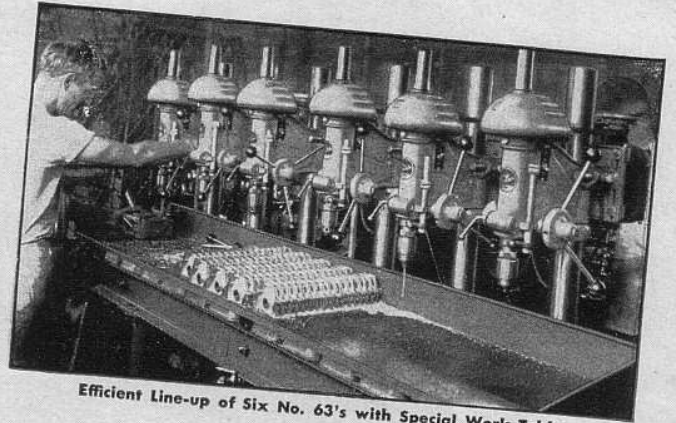

Efficient Line-up of Six No. 63's with Special Work Table

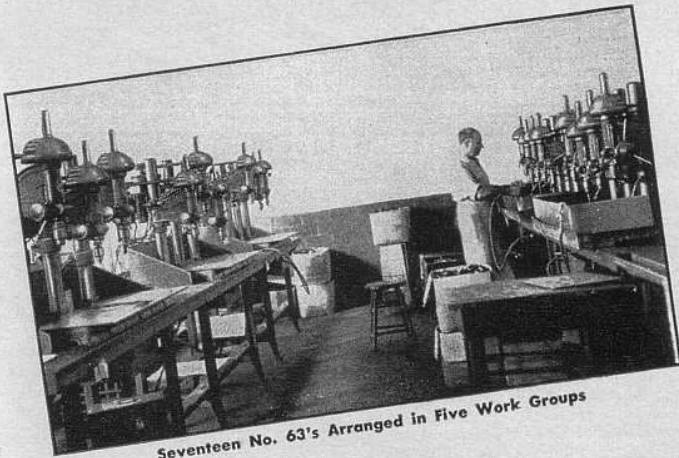

Seventeen No. 63's Arranged in Five Work Groups

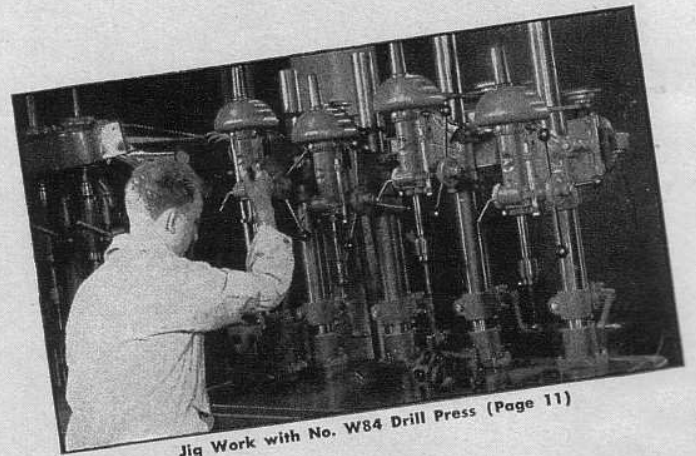

Jig Work with No. W84 Drill Press (Page 11)



Nine No. 73's Handling All Operations on Intricate Parts

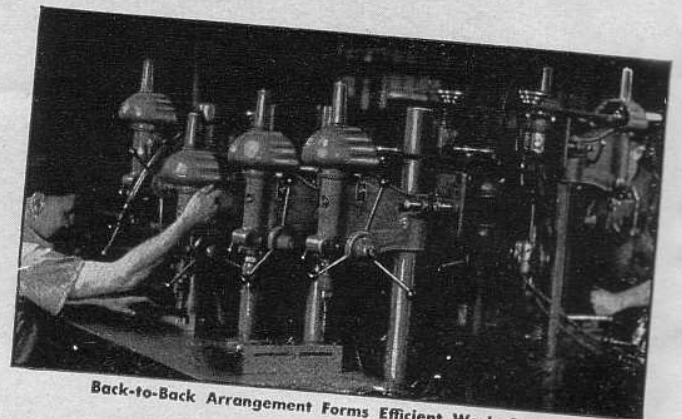

Back-to-Back Arrangement Forms Efficient Work Center

Atlas

RUGGED ACCURATE

"FLOATING

★ FOR EFFICIENCY and CONVENIENCE

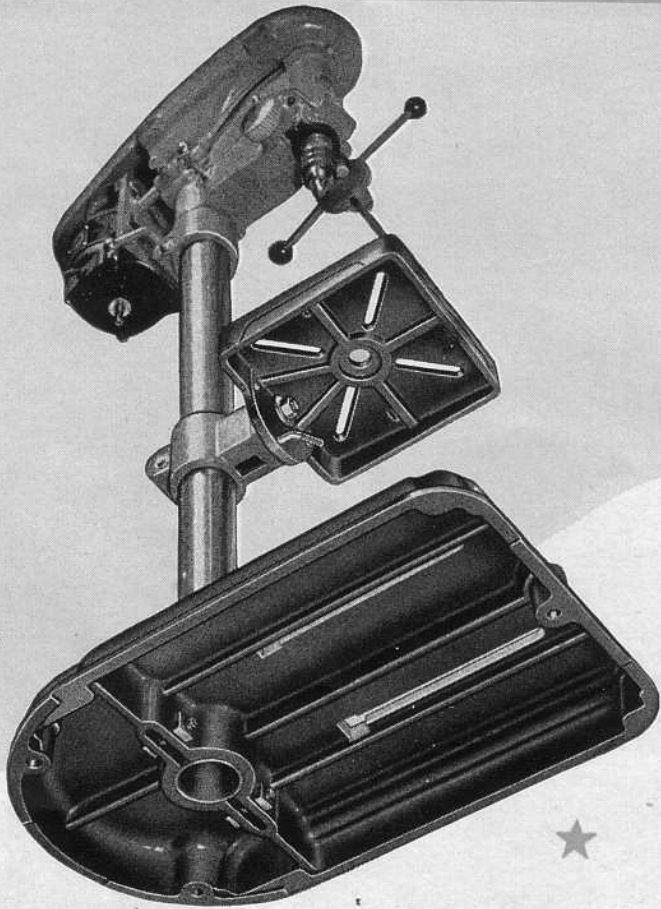

HEAVY, MASSIVE BASE, TABLE and HEAD

The drill press base, table, and head are massive iron castings, extra heavy and scientifically rib-braced for maximum rigidity, inside and outside. The base casting forms a solid foundation for the entire drill press. The thickly ribbed table is a rigid, accurate working surface. The heavy well-braced head casting is a strong, rigid, fully enclosed housing for the spindle-bearing assembly.

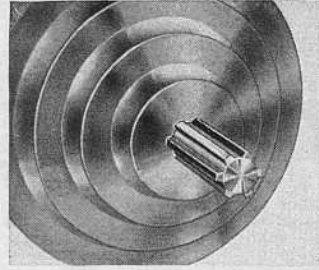

SIX-SPLINED SPINDLE AND PULLEY—Maintain spindle alignment and transmit maximum power to the drill without whip or backlash. Spindle is special alloy steel ground to extremely close tolerances.

Matched and balanced pulleys, combined with splined drive, practically eliminate vibration. Removable cap and iron safety guard cover spindle and pulley.

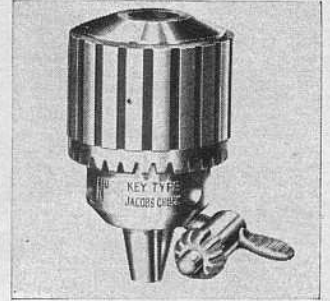

PRECISION JACOBS CHUCK—Accurate spindle alignment plus precision Jacobs chuck, the finest available, means maximum accuracy at the drill point. Capacity No. 70 to 1/2" drill. No. 1 Morse taper spindle is available.

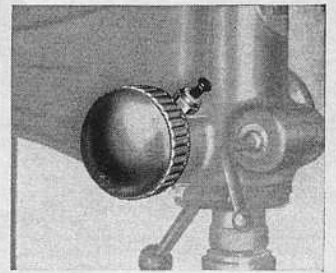

ADJUSTABLE FEED TENSION—Provides any desired feed tension. Heavy-duty spring housed in cap shown above controls tension on feed pinion shaft. Tension is set by turning ratchet device, released with button.

Pinion gear, controlled by 3-spoke feed wheel, meshes with quill rack, advancing spindle to work. Accurately machined teeth and adjustable spring mechanism give feather-touch feeding.

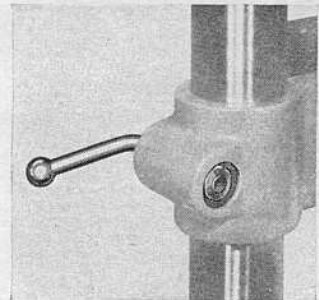

COORDINATE CLAMP LOCKS—For head, column collar, table support and quill. Ball handle tightens and releases two clamping wedges simultaneously. Permits quick, rigid positioning without scoring or distorting quill or column.

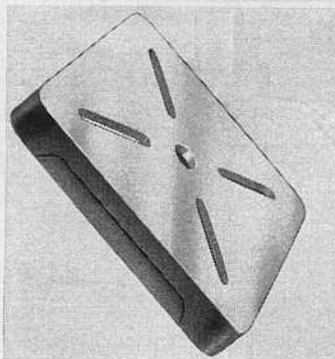

FULL-TILTING TABLE—Heavy, well-braced, machine ground casting—a rigid, accurate working surface. May be tilted to any desired angle, right or left, and locked securely. 90° and horizontal positions are indexed. Table support casting is line-bored to fit column, accurately machined and fitted to table.

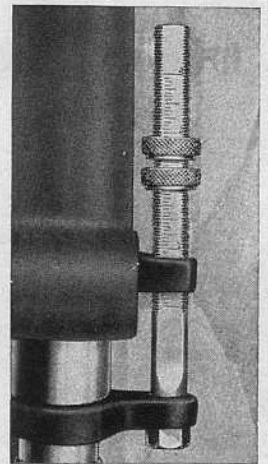

DEPTH INDICATOR—Graduated in 1/16ths. Has two knurled feed-stop nuts. Design eliminates rotational play in drill press quill.

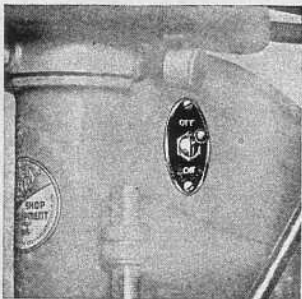

MOTOR CONTROL SWITCH—Built into head at convenient position near feed wheel within easy reach. Switch is 10 ampere at 110 volt, toggle type.

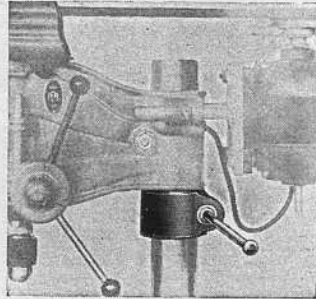

COLUMN COLLAR—Furnished with Nos. 63 and 73 drill presses. Simplifies raising and lowering head and permits swinging head for drilling at different points on large, heavy work. Lock is coordinate type.

DRIVE" Spindle Bearing Design

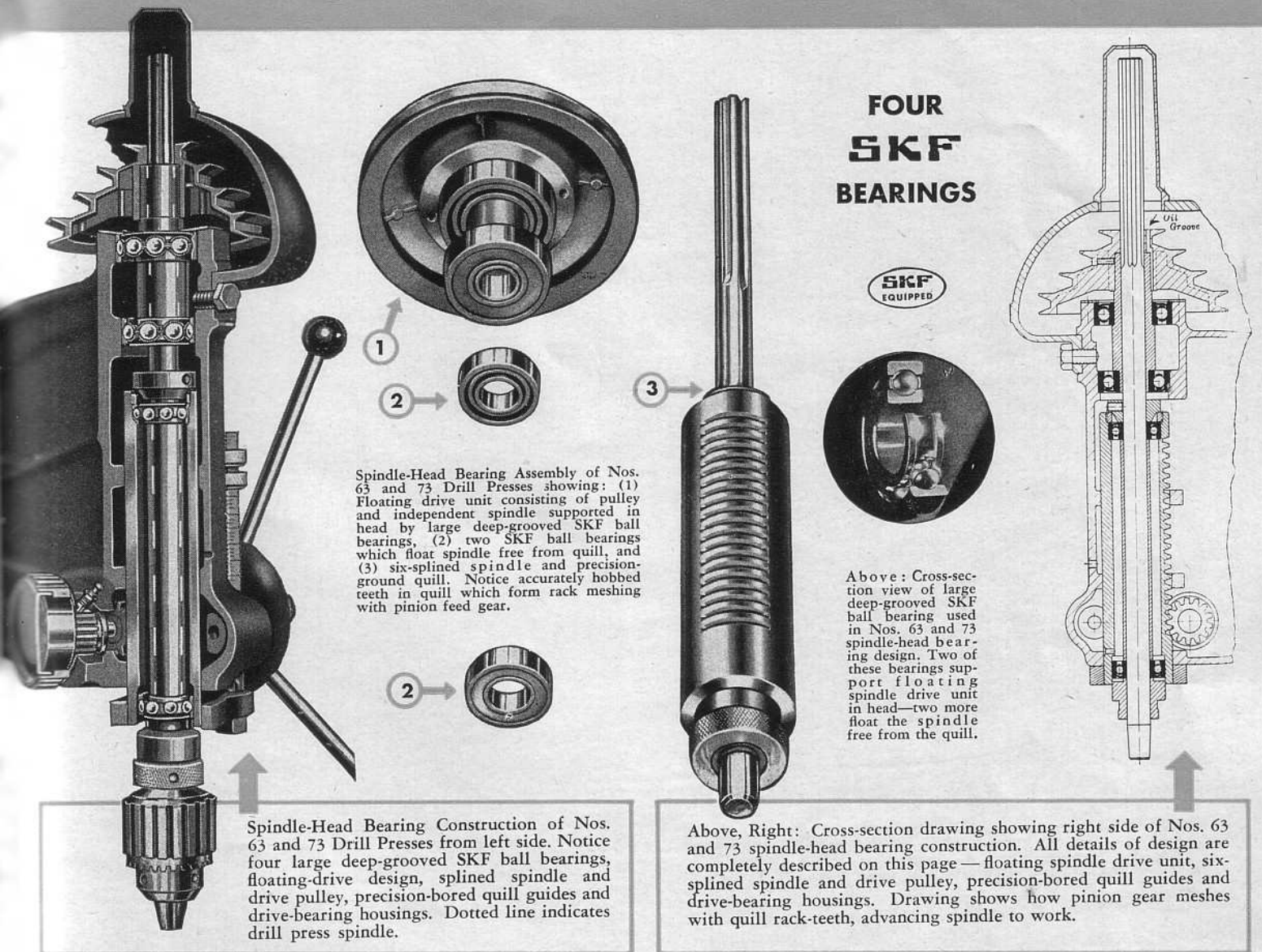

Spindle-Head Bearing Assembly of Nos. 63 and 73 Drill Presses showing: (1) Floating drive unit consisting of pulley and independent spindle supported in head by large deep-grooved SKF ball bearings, (2) two SKF ball bearings which float spindle free from quill, and (3) six-splined spindle and precision-ground quill. Notice accurately hobbled teeth in quill which form rack meshing with pinion feed gear.

Spindle-Head Bearing Construction of Nos. 63 and 73 Drill Presses from left side. Notice four large deep-grooved SKF ball bearings, floating-drive design, splined spindle and drive pulley, precision-bored quill guides and drive-bearing housings. Dotted line indicates drill press spindle.

**FOUR
SKF
BEARINGS**



Above: Cross-section view of large deep-grooved SKF ball bearing used in Nos. 63 and 73 spindle-head bearing design. Two of these bearings support floating spindle drive unit in head—two more float the spindle free from the quill.

Above, Right: Cross-section drawing showing right side of Nos. 63 and 73 spindle-head bearing construction. All details of design are completely described on this page—floating spindle drive unit, six-splined spindle and drive pulley, precision-bored quill guides and drive-bearing housings. Drawing shows how pinion gear meshes with quill rack-teeth, advancing spindle to work.

★ RUGGED, ACCURATE SPINDLE-HEAD BEARING CONSTRUCTION

To handle production drilling and tapping and give long, accurate service at high speeds, today's drill press requires a rugged and accurate spindle-head bearing construction. The cross-section views on this page show in detail how Atlas heavy-duty drill presses meet this requirement.

The Atlas drill press head is a heavy, well braced casting — a strong, rigid, fully enclosed housing for the entire spindle-bearing assembly comprising spindle, quill, spindle-driving unit, and feed-control mechanism. The three quill guides and two drive-bearing housings are precision-bored for perfect concentricity of the quill with the drive unit for accurate spindle alignment. By boring holes for the column at the same setting, accurate alignment with the column is obtained.

Spindle drive unit — consisting of the six-splined pulley mounted on an independent tubular steel spindle supported in the head by large deep-grooved SKF ball bearings — IS ENTIRELY

SEPARATE FROM THE DRILL PRESS SPINDLE. This floating drive transmits turning power only to the spindle — all belt pull is taken to the head through the drive unit.

The steel quill is precision ground. Two SKF ball bearings float the spindle free from the quill. The accurately bored quill guides provide three widely spaced supports to maintain quill alignment through its full travel.

The spindle is supported firmly at widely separated points — by the six-splined drive pulley at one end, the lower quill bearing at the other, and between these by upper quill bearing. This design maintains alignment as spindle is advanced into work, eliminates spindle whip, assures sensitive feeding, smooth accurate performance.

The heavy massive base casting is a rigid foundation for the entire drill press. It provides an auxiliary table for extra long work. The rugged ground steel column maintains accurate alignment of head, table, and base.

Atlas Nos. 63 and 73 15-inch

No. 63 15-INCH HEAVY DUTY Bench Type DRILL PRESS

Pages 4 and 5 describe in detail the construction which has made the Atlas 63 preferred by manufacturers for high speed production drilling and tapping. The superior spindle-head bearing design means increased output and long service life. Initial cost is extremely low and the $\frac{1}{3}$ or $\frac{1}{2}$ H.P. motor requirement keeps operating expense at a minimum. The face of the base is ground to serve as an auxiliary table for long work. Production oil table, tapping attachments, and safety belt guard are completely described on page 8; coolant pumps page 12.

All-around utility makes the No. 63 a favorite in every type of shop. It handles quickly and easily such operations as: shaping, mortising, routing, carving, sanding, and general drilling in metal and wood.

No. 63 15" HEAVY-DUTY BENCH TYPE DRILL PRESS WITH No. 70 to $\frac{1}{2}$ " JACOBS CHUCK complete as shown with belt and motor pulley, less motor. Code word ZEBSE, weight 125 lb.....

No. 63-IM 15" HEAVY-DUTY BENCH TYPE DRILL PRESS WITH NO. 1 MORSE TAPER in place of chuck. Complete with belt and motor pulley, less motor. Code word ZECAS, weight 125 lb. ($\frac{3}{8}$ " diameter spindle— $1\frac{1}{4}$ " capacity over table).....

Morse taper spindle does not accommodate standard drill press attachments.

SPECIFICATIONS No. 63 DRILL PRESS

Drills to Center of Circle.....	15" diameter
Chuck Capacity.....	$\frac{1}{2}$ "
Spindle Travel.....	4"
Maximum Distance Table to Chuck.....	12"
Maximum Distance Base to Chuck.....	16"
Table Travel.....	12"
Size of Table.....	10" x 10"
9 Speeds between.....	600 and 5200 R.P.M.
With Hi-Lo Speed Attachment (below).....	Low Speed 200 R.P.M.
Ground Steel Column.....	$2\frac{3}{4}$ " diameter
Overall Height.....	41"
Overall Width.....	12"
Overall Depth with Motor.....	24"
Shipping Weight less Motor.....	125 lb.
Motor Recommended.....	$\frac{1}{3}$ or $\frac{1}{2}$ H.P. 1725 R.P.M. Ball Bearing

Built-in Switch Furnished.....10 Amperes at 110 volts.
Switch is for single phase current only.....3-phase controls, page 8.

Motor pulley furnished is for $\frac{1}{2}$ " diameter motor shaft
—prices of pulleys for other motor shafts on request.

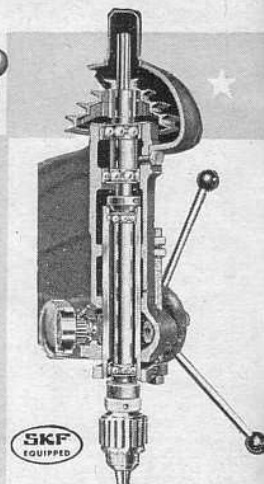
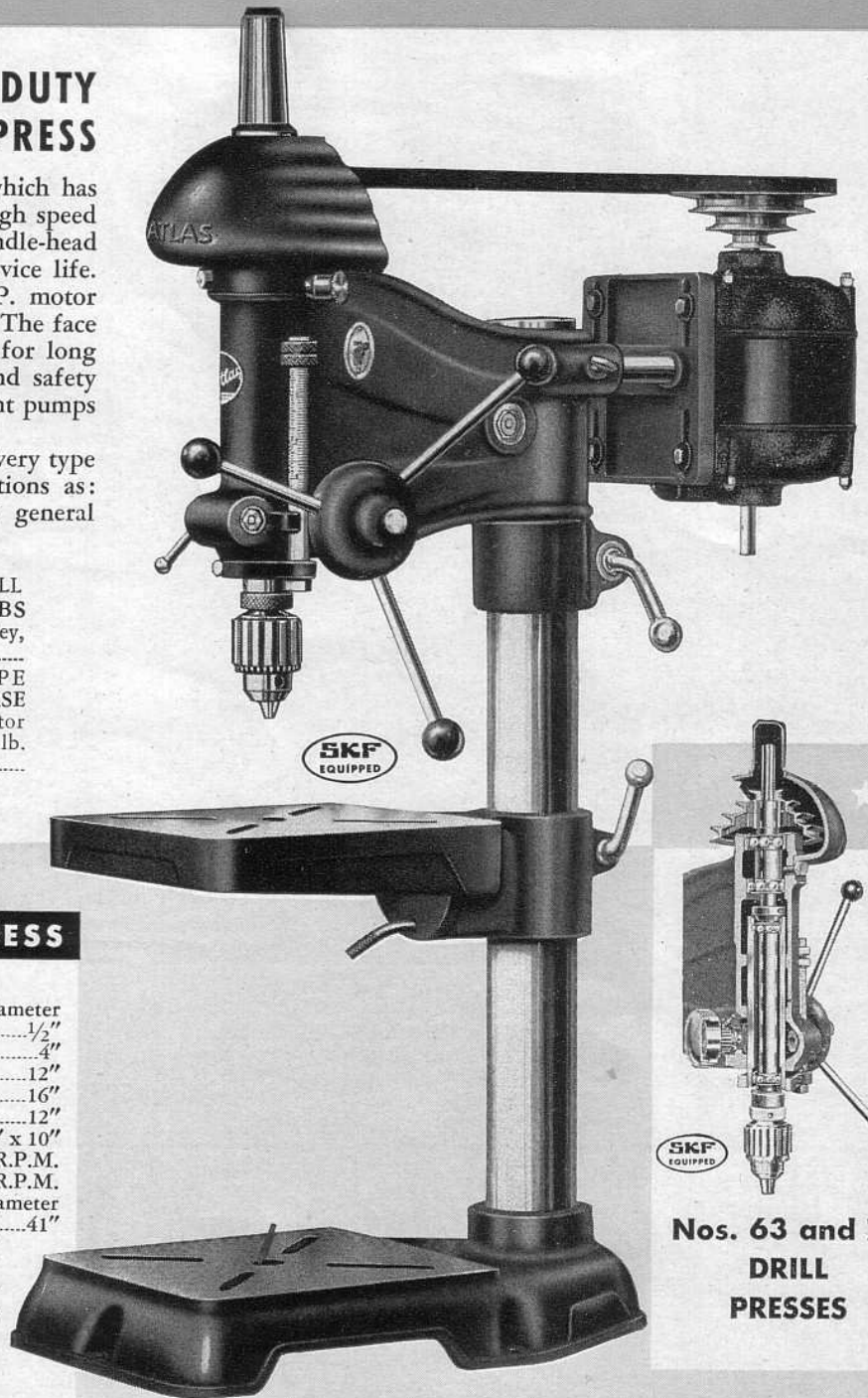

**Nos. 63 and 73
DRILL
PRESSES**

ATTACHMENTS and ACCESSORIES No. 63



TAPPING ATTACHMENTS

For high-speed production tapping. See page 8.

No. W39A TAPPING ATTACHMENT with tap holder and 7 collets. Code ZAERF, wt. 13 lb.

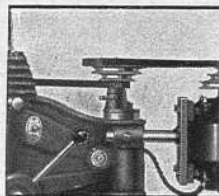

SPEED ATTACHMENT

Provides low speed of 200 RPM and higher than standard speeds. See page 15.

W15 HI-LO ATTACHMENT for 60 and 70-series drill presses. Code ZAFTO, wt. 6 lb.....

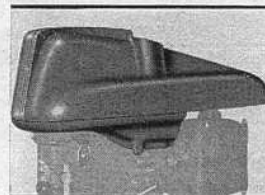

SAFETY GUARD

Covers belt, pulleys, and spindle—easily raised to change speeds.

See page 8.

SAFETY GUARD ordered with 63 or 73-series drill press, extra.....

HEAVY DUTY DRILL PRESSES

No. 73 15-INCH HEAVY DUTY Floor Type DRILL PRESS

The Atlas No. 73 has a rugged floor-type mounting, 40½" capacity over table and 46" capacity over base. Spindle-head bearing design with floating-drive, splined spindle and drive pulley, adjustable feed return, precision Jacobs chuck, full-tilting table — all the modern construction features of the 73 are fully described on pages 4 and 5.

Equipped with the No. W33 foot-lever feed control (page 8), the 73 drill press is an ideal machine for repetitive drilling and tapping operations. Other production accessories are also shown on page 8 — coolant pumps, page 12.

No. 73 15" HEAVY-DUTY FLOOR TYPE DRILL PRESS WITH No. 70 to ½" JACOBS CHUCK complete as shown with belt and motor pulley, less motor. CODE ZECIV, wt. 175 lb.....

No. 73-1M 15" HEAVY-DUTY FLOOR TYPE DRILL PRESS WITH No. 1 MORSE TAPER in place of chuck. Complete with belt and motor pulley, less motor. Code word ZECUX, weight 175 lb. (⅝" diameter spindle — 39¾" capacity over table)

Morse taper spindle does not accommodate standard drill press attachments.

SPINDLE-HEAD BEARING DESIGN

Nos. 63 and 73 Drill Presses

Complete Description, Page 5

Cross section view showing spindle-head bearing construction of Nos. 63 and 73 heavy-duty drill presses. Spindle driving unit is entirely separate from drill press spindle. Notice four deep-grooved SKF ball bearings, splined spindle and drive pulley, precision-bored quill guides and drive-bearing housings.

SPECIFICATIONS No. 73 DRILL PRESS

Drills to Center of Circle.....	15" diameter
Chuck Capacity.....	½"
Spindle Travel.....	4"
Maximum Distance Table to Chuck.....	40½"
Maximum Distance Base to Chuck.....	46"
Table Travel.....	40½"
Size of Table.....	10" x 10"
9 Speeds between.....	600 and 5200 R.P.M.
With Hi-Lo Speed Attachment (below, left).....	Low Speed 200 R.P.M.
Ground Steel Column.....	2¾" diameter
Overall Height.....	71"
Overall Width.....	14"
Overall Depth with Motor.....	30"
Shipping Weight less Motor.....	175 lb.
Motor Recommended.....	⅓ or ½ H.P. 1725 R.P.M. Ball Bearing

Built-in Switch Furnished.....10 Amperes at 110 volts.
Switches for single phase current only.....3-phase controls, page 8.

Motor pulley furnished is for ½" diameter motor shaft — prices of pulleys for other motor shafts on request.



and 73 DRILL PRESSES

OIL TABLE

10½" x 16½" working surface.

See page 8.

OIL TABLE ordered with 63 or 73-series drill press in place of standard full-tilting table. Extra.....

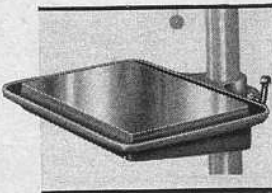

COOLANT PUMPS

Efficient, compact, portable. See page 12.

No. W88 COOLANT PUMP with 2½ gal. tank, cord, switch and plug. Capacity 3.75 GPM. Code ZEIRL, wt. 17 lb.....



MOTORS

SKF ball bearings, ½" single-end shaft, cord and plug. Operate in any position. See page 8.

No.	HP	Wt.
2520B	⅓	33 lb.
2530A	½	40 lb.

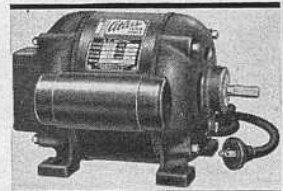

PRODUCTION ACCESSORIES

FOR Nos. 63 and 73
DRILL PRESSES

Pictured at the right is the Atlas 73 drill press equipped to handle high-speed production operations. The complete machine includes No. 73 drill press with:

- No. 61-2S Production Oil Table
- No. W33 Foot Lever Feed Control
- No. W39A Tapping Attachment
- No. 62-7A Safety Belt Guard

These accessories are fully described on this page.

THREE PHASE MOTORS

The motors listed below are designed for use with three-phase current. All are 1725 RPM, 60 cycle—have SKF ball bearings, 1/2" single-end shaft. Furnished with BX connector in terminal box—do not have switch, cord, or plug.

No.	HP	Voltage	Wt.	Code
2630	1/3	220	28 lb.	ZEWPE
2620	1/2	220	35 lb.	ZEWRO
2635	1/3	440	28 lb.	ZEWYT
2625	1/2	440	35 lb.	ZEWUS

THREE PHASE SWITCH

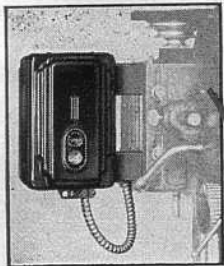

Required with 3-phase motor. Thermal overload 3-pole manual starters for 3-phase circuits. Mounting bracket and flexible cable-covered motor connection cord are furnished.

No. W67 THREE PHASE SWITCH for Nos. 53, 63 and 73 drill presses, with mounting bracket and connections. Code ZECET, wt. 6 lb.....

No. W86 THREE PHASE SWITCH for multiple spindle drill presses, with mounting bracket and connections. Code ZEIKD, wt. 6 lb.....

SAFETY GUARD

for Belt, Pulleys and Spindle

This light, durable shield provides a safety cover for the complete drill press drive mechanism, as required by industrial and vocational safety codes in most states. Pin hinges permit quick raising for speed changes — it is not necessary to remove guard to change belts. Spring clip holds guard closed.

SAFETY GUARD ordered with 63 or 73 series drill press. Extra.....

No. 62-7A DRILL PRESS SAFETY GUARD for 60 and 70 series drill presses, ordered separately. Ready tapped for easy installation. Code ZABSY, wt. 7 lb.....

TAPPING ATTACHMENTS

See Complete Description Below

Available in two sizes: No. W39A to tap up to 5/16" in steel, 3/8" in cast iron, and 1/2" in brass; and No. W39 to tap up to 3/16" in steel, and 1/4" in brass and cast iron.

PRODUCTION OIL TABLE

For production work with jigs and fixtures. Can be furnished with Nos. 63 and 73 drill presses in place of standard full-tilting table. Has 10 1/2" x 16 1/2" ground working surface and drain channel to remove oil or cutting compound. Held firmly in position by coordinate clamp lock. Extra weight and proper bracing assure maximum rigidity and accurate work.

PRODUCTION OIL TABLE ordered with No. 63 or No. 73 series drill press in place of standard table. Extra.....

No. 61-2S PRODUCTION OIL TABLE for 60 and 70 series drill presses. Ordered separately—Code ZABUR, 65 lb.....

FOOT-LEVER FEED CONTROL

Speeds up any repetitive operation with 70-Series drill presses. Accuracy is improved because the operator has both hands free to hold and guide the work.

Includes draw rod mounted between two arms, one for foot pedal and one for drill press spindle. Heavy-duty return spring has 3 positions on spindle arm and tension nut for quick adjustment. Draw rod can be bolted at any one of 4 positions on foot lever arm.

No. W33 FOOT LEVER FEED CONTROL for 70-series drill presses complete as shown. Code word ZAETH, wt. 31 lb... Note: No. W33 is not recommended for production mortising. Please specify if foot lever feed control will be used on drill press equipped with Hi-Lo speed attachment (page 15).

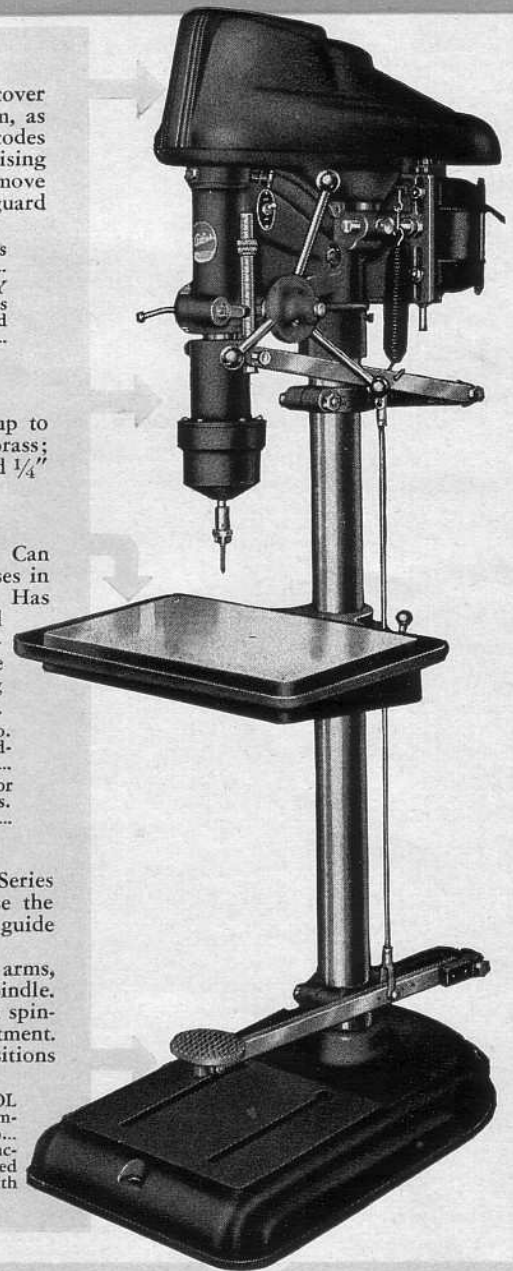

Atlas TAPPING ATTACHMENTS

For High-Speed Production Tapping

These Atlas tapping attachments convert any 60 or 70 series drill press into a sensitive high-speed production tapping machine. They meet the modern demand for a light, compact, accurate taper.

The lightweight durable housing encloses a 3-point balanced, heat-treated gear reversing mechanism which distributes pull to three gears, minimizing wear and eliminating torsion. Improved head design—chuck rotates in tapping direction when idling. This construction means a more sensitive head and increases tap life. Reverse speed is twice forward speed. Double-cone friction clutch has cork facing—spindle turns on ball bearings.

These tapping attachments have tapered socket for drill press spindle and cover which clamps directly to quill. No adapters necessary. Atlas tapping attachments are available for drill presses with Morse taper spindles—details on request.

No. W39A TAPPING ATTACHMENT complete with "Tru-Grip" tap holder and 7 collets for following taps: Nos. 8, 9, 10, 1/4", 5/16", 3/8" (shank diameter .381"), 7/16", and 1/2". CAPACITY: No. 8 tap to 3/8" in steel, 3/4" in cast iron, 1/2" in brass. Code word ZAERE, wt. 13 lb.....

No. W39 TAPPING ATTACHMENT complete with "Tru-GRIP" tap holder and 4 collets for following taps: Nos. 2, 3, 4, 5, 6, 7, 8, 9, 10, and 1/4". CAPACITY: up to 1/8" in steel, 1/4" in brass and cast iron. Code ZAEMZ, wt. 7 lb.....

"TRU-GRIP" TAP HOLDER

The "Tru-Grip" tap holder furnished with Atlas tapping attachments is light in weight, accurate and has no delicate parts to cause trouble. Spring collets are furnished—both holder and collets are hardened and ground.

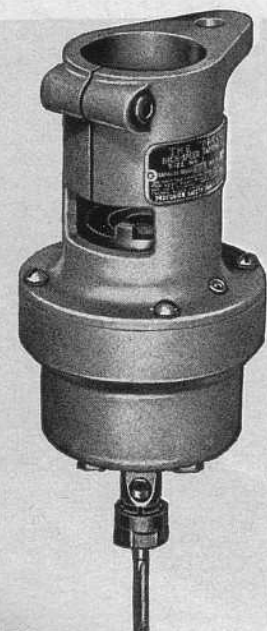
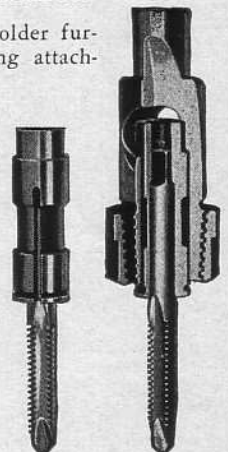

Atlas

No. 53

12³/₄"
BENCH
TYPE

DRILL PRESS



The No. 53 drill press is an excellent general purpose machine for the average shop. It drills to the center of a 12³/₄" circle, has 3" spindle travel, takes 9³/₄" over table, and is equipped with precision Jacobs chuck. It handles the full range of drill press operations—mortising, shaping, sanding, carving, and routing.

The spindle-head bearing design of the No. 53 incorporates a new flexible-type drive (U.S. Patent 2287391) which insures smoother, more quiet operation at all speeds. The floating drive bearing is a large deep-grooved SKF ball bearing mounted in the pulley. Two more ball bearings float the spindle free from the quill. Vibrations and belt pull are absorbed by a special flexible coupling.

The No. 53 drill press head is a heavy accurately machined casting—a strong, fully enclosed housing for the spindle and bearings. Matched and balanced pulleys, combined with splined drive, practically eliminate vibration. Precision Jacobs chuck, graduated depth indicator, three-spoke feed wheel, built-in 10 ampere motor control switch, and adjustable motor mounting bracket are furnished. Drive pulley and splined spindle are completely enclosed by iron guard and cap. Clamp locks for head, quill, and table support are coordinate type. Full tilting table is accurately ground. Heavy base is a rugged support—face is ground to serve as table for long work. Column is 2¹/₄" ground steel

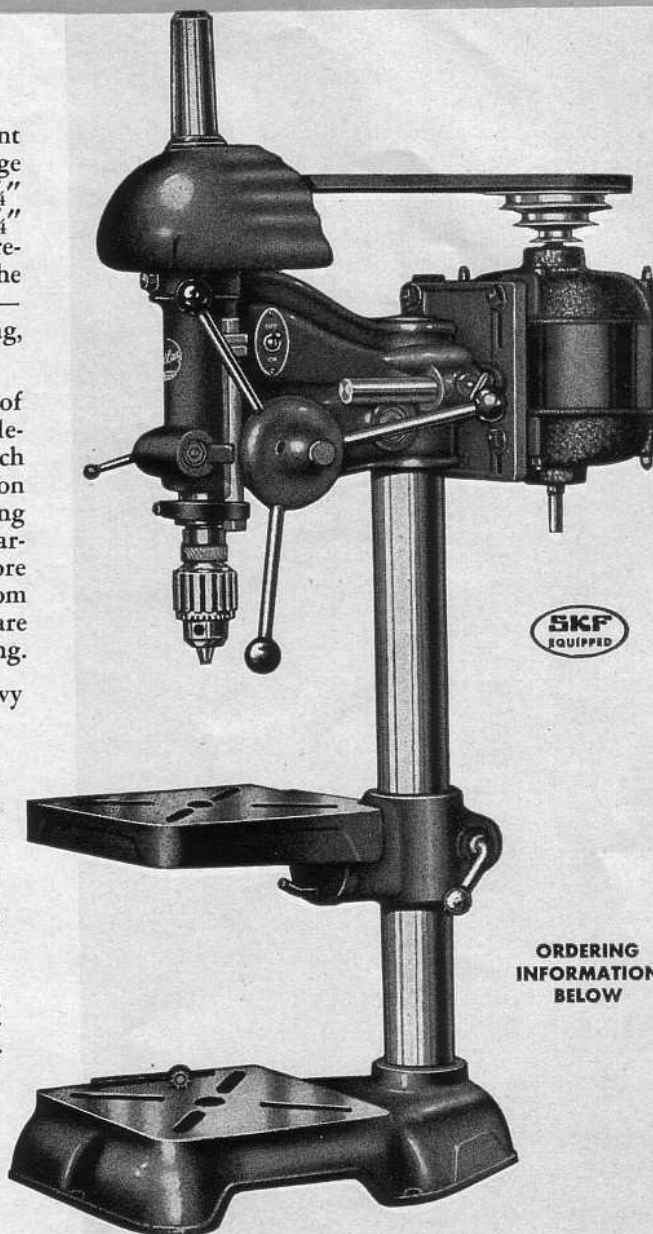

ORDERING
INFORMATION
BELOW

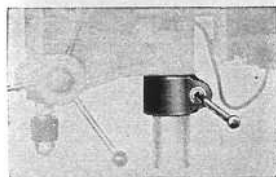

COLUMN COLLAR

Simplifies raising, lowering, and moving drill press head.

No. 52-75B COLUMN COLLAR. Code word ZEHZE, weight 3¹/₂ lb.....

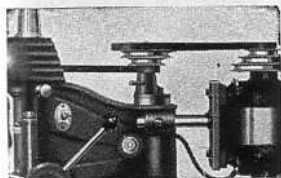

SPEED ATTACHMENT

Provides low speed of 200 RPM and higher than standard speeds. V-belts furnished—see page 15.

No. W14B HI-LO SPEED ATTACHMENT for 53 drill press. Code word ZEKFO, weight 6 lb.....



BELT RELEASE

Speeds up belt changes—complete description page 15. V-belt furnished.

QUICK-CHANGE BELT RELEASE ordered with 53 drill press. Extra.....

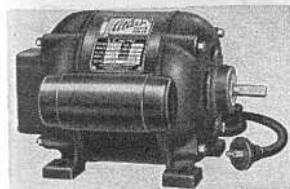

MOTORS

SKF ball-bearings. Operate in any position. Single phase, capacitor start.

No.	HP	Wt.	Code
2520B	1/3	33 lb.	ZEWOR
2530A	1/2	40 lb.	WYZIC

SPECIFICATIONS No. 53 DRILL PRESS

Drills to Center of Circle.....	12 ³ / ₄ " diameter	9 Speeds between.....	600 and 5200 RPM
Chuck Capacity	1/2"	With Hi-Lo Speed Attachment (left).....	Low Speed 200 RPM
Spindle Travel.....	3"	Overall Height	36"
Maximum Distance Table to Chuck.....	9 ³ / ₄ "	Overall Width	11"
Maximum Distance Base to Chk :k.....	13 ¹ / ₂ "	Overall Depth with Motor.....	24"
Table Travel.....	9 ³ / ₄ "	Shipping Weight Less Motor.....	95 lb.
Size of Table.....	8" x 9"	Motors Recommended.....	1/3 or 1/2 HP, 1725 RPM Ball Bearing (left)
Ground Steel Column.....	2 ¹ / ₄ " diameter		

No. 53 12³/₄" BENCH TYPE DRILL PRESS WITH No. 70 to 1/2" JACOBS CHUCK complete as shown with belt and motor pulley, less motor. Code word ZEWTY, shipping weight 95 pounds.....

Built-in Switch Furnished . . . 10 Amp. at 110 volt. Switch is for single phase current only. 3-phase controls, page 8. Motor pulley furnished is for 1/2" diameter motor shaft—prices of pulleys for other motor shafts on request.

ORDERING INFORMATION

To Step Up Production

on small-hole drilling and tapping, put these Atlas drill presses on the job. They eliminate waste motion in manufacturing any part requiring a series of drilled and tapped holes. Their cost is surprisingly low.

The massive production table provides plenty of "elbow room" for the smooth movement of large heavy jigs and fixtures. The famous Atlas 4-bearing floating drive makes the drilling action smooth and sensitive. Each drill head is equipped with its own motor mounting and a unique type of control which positions the head with a few turns of a crank handle. Modern convenience features boost output by saving operator's time and effort. $\frac{1}{3}$ or $\frac{1}{2}$ HP motor requirement cuts power cost.

Let us help you economize on the repetitive drilling operations in your plant. The services of the entire Atlas engineering staff are at your disposal.

RUGGED TABLE AND FLOOR LEGS — The massive production oil table of these Atlas drill presses is a heavy grey iron casting, braced rigidly by a network of thick ribs covering the entire bottom surface. Table alone of the 3- and 4-spindle machines weighs 575 pounds! The table working surface is accurately planed square with the drilling spindles to insure accurate work with jigs and fixtures. Drain channel removes oil or cutting compound.

The floor legs are heavy solid well-braced iron castings, each held firmly to the table by three $\frac{1}{2}$ " cap screws. A wood shelf 11" from the floor provides convenient space for tools and jigs.

FLOATING-DRIVE SPINDLE DESIGN — Atlas multiple spindle drill presses incorporate the famous Atlas SKF-equipped spindle head bearing construction featured in all Atlas heavy-duty drill presses. Details are completely described on pages 4 and 5. More than any other single factor, this fine head design accounts for new operating records set by Atlas drill presses in hundreds of the largest, most efficient production plants.

ATLAS HEAD POSITIONING CONTROL — Simply turning a crank handle raises or lowers the drill head on the support column, a unique design which reduces set-up time to a minimum. The elevating screw controls a column collar below the drill head — screw has ball thrust bearing at lower end. Head clamping lock is coordinate type for quick, rigid positioning without scoring column.

The head support columns are $2\frac{3}{4}$ " diameter ground steel locked securely to the table by 4"-high split type brackets, each anchored by four $\frac{3}{8}$ " cap screws.

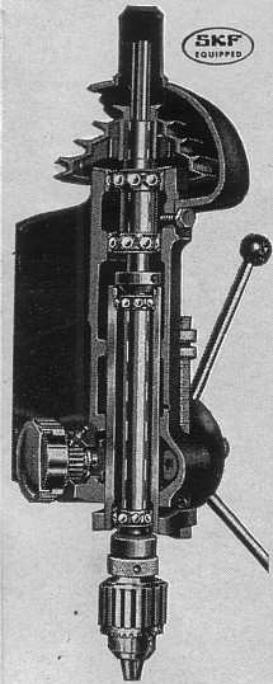

FLOATING-DRIVE SPINDLE DESIGN

Drilling heads of the Atlas multiple spindle drill presses are equipped with the well-known Atlas SKF spindle-head bearing construction. Cross section view from the left side (above) shows all the details of this "floating drive," completely described on page 5. Notice four large deep-grooved SKF ball bearings, floating spindle drive unit, six-splined spindle and drive pulley, precision-bored quill guides and drive bearing housings. Dotted line indicates drill press spindle.

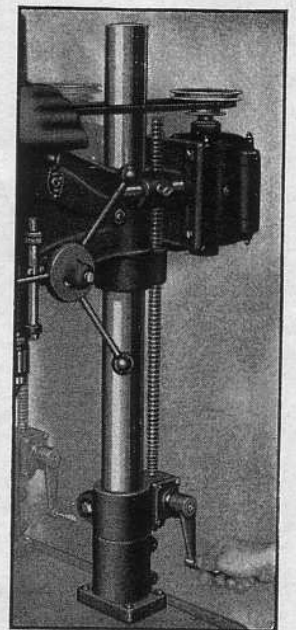

Head Position Control

DETAILS OF CONSTRUCTION — ATLAS DRILLING HEADS

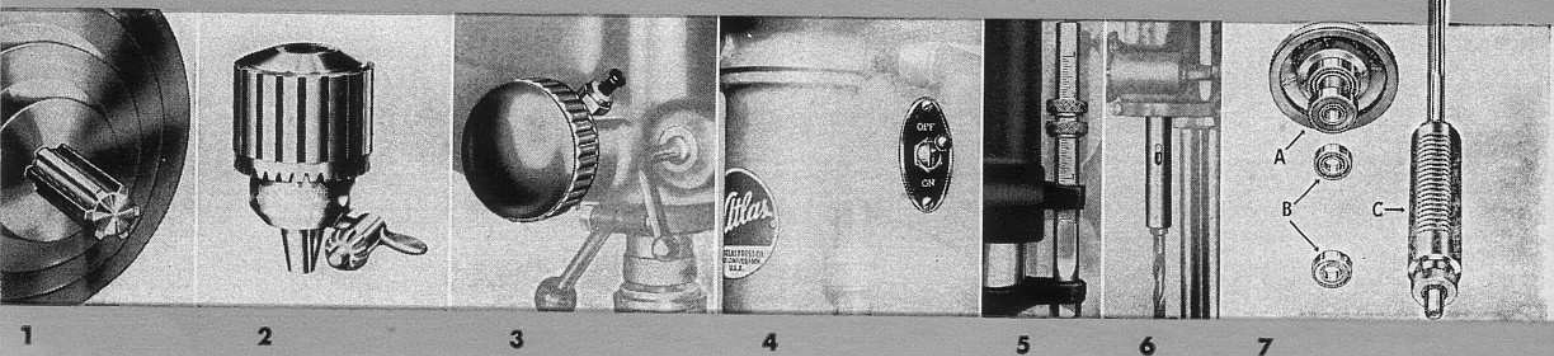

1. SIX-SPLINED SPINDLE AND PULLEY maintain spindle alignment and transmit maximum power to the drill without whip or backlash. Matched and balanced pulleys, combined with splined drive, practically eliminate vibration. **2. PRECISION JACOBS CHUCKS** — Accurate spindle alignment plus precision Jacobs chucks means maximum accuracy at the drill point. **3. ADJUSTABLE FEED TENSION** — Turning ratchet device provides any desired feed tension. Accurately machined feed mechanism and adjustable tension give feather-touch feeding. **4. MOTOR CONTROL SWITCH** built into head at convenient position near feed wheel within easy reach. **5. DEPTH INDICATOR** graduated in $\frac{1}{16}$ ths. Has two knurled feed-stop nuts. **6. MORSE TAPER SPINDLES** can be furnished to accommodate No. 1 Morse taper shank drills. Ordering information page 11. **7. SPINDLE-HEAD BEARING ASSEMBLY** showing: (A) Floating drive unit consisting of pulley and independent spindle supported in head by large deep-grooved SKF ball bearings, (B) two SKF ball bearings which float the spindle free from quill, and (C) six-splined spindle and precision-ground quill. Notice accurately hobbled teeth in quill which form rack meshing with pinion feed gear.

SPINDLE DRILL PRESSES



Atlas No. W83

Three-Spindle Drill Press with Jacobs No. 70-1/2" Chucks, floor legs, less motors....Code ZAJTA

Net Weight less Motors..960 lb.
Table Surface.....21" x 54"
Center to Center of Spindles..18"

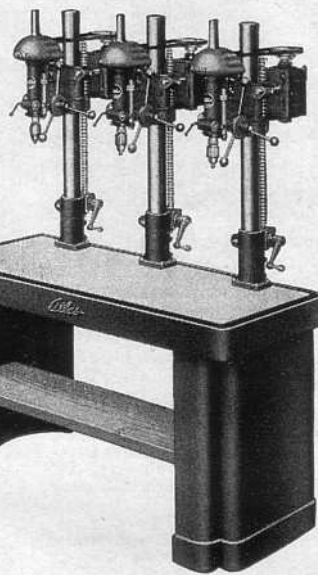

Atlas No. W82

(Below) Two-Spindle Drill Press with Jacobs No. 70-1/2" Chucks, complete with floor legs, less motorsCode ZAJJOY

Net Weight less Motors.....735 lb.
Table Surface.....21" x 30"
Center to Center of Spindles15"

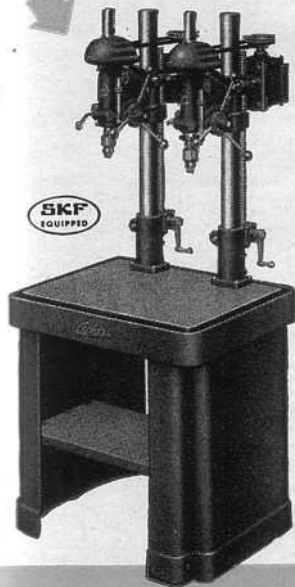

Atlas No. W84

Four-Spindle Drill Press with Jacobs No. 70-1/2" Chucks, complete with floor legs, less motors..Code ZAJUZ

Net Weight less Motors.....1040 lb.
Table Working Surface.....21" x 54"
Center to Center of Spindles.....13"

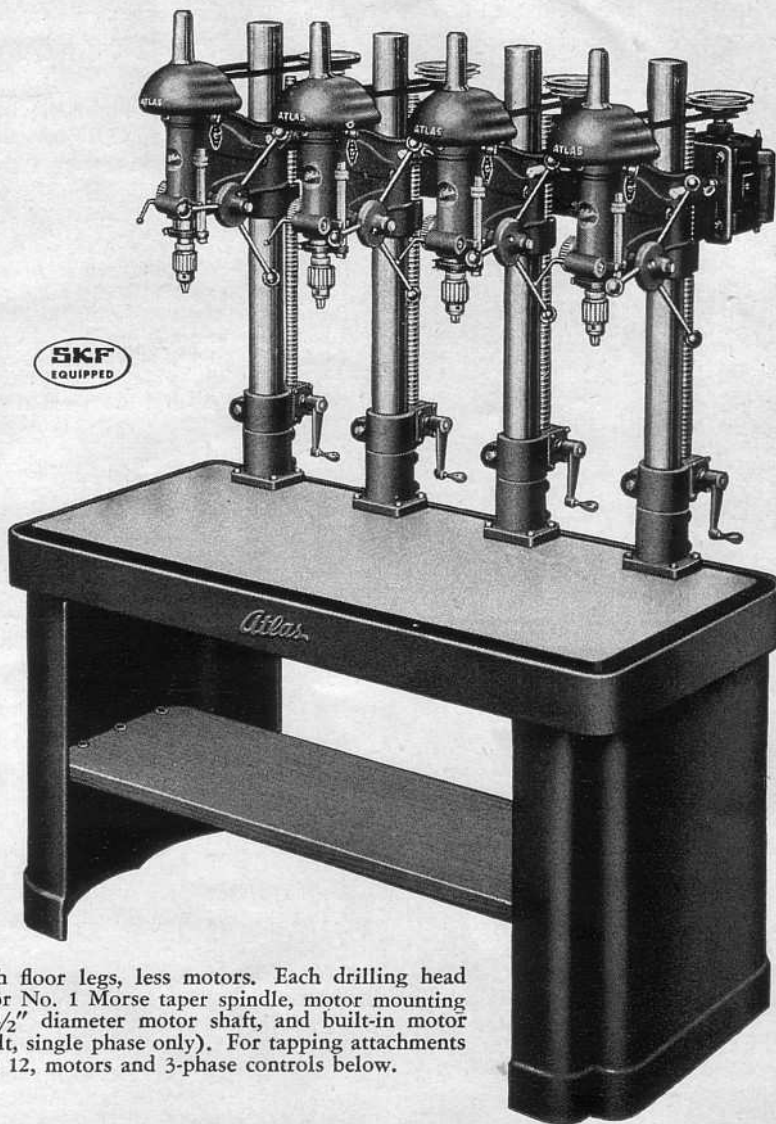

FURNISHED complete as shown with floor legs, less motors. Each drilling head includes: Jacobs No. 70-1/2" chuck or No. 1 Morse taper spindle, motor mounting bracket, V-belt, motor pulley for 1/2" diameter motor shaft, and built-in motor control switch (10 ampere at 110 volt, single phase only). For tapping attachments refer to page 8, coolant pumps page 12, motors and 3-phase controls below.

SINGLE-PHASE MOTORS

The 1725 RPM 60 cycle motors listed below are recommended for the Atlas multiple spindle drill presses. Both are capacitor-start, developing full power instantly under load without drawing excess current. Have large SKF ball bearings and 1/2" single-end shaft. Furnished with 10 ft. SJ approved extension cord and plug.

No.	HP	Voltage	Wt.	Code Word
2520B	1/3	110/220	33 lb.	ZEWOR
2530A	1/2	110/220	40 lb.	WYZIC

THREE-PHASE MOTORS

These motors are designed for use with three-phase current. All are 1725 RPM, 60 cycle — have SKF ball bearings, 1/2" single-end shaft. Furnished with BX connector in terminal box — do not have switch, cord, or plug.

No.	HP	Voltage	Wt.	Code Word
2630	1/3	220	28 lb.	ZEWPE
2620	1/2	220	35 lb.	ZEWRO
2635	1/3	440	30 lb.	ZEWYT
2625	1/2	440	35 lb.	ZEWUS

THREE-PHASE SWITCH

No. W86 switch is required with a 3-phase motor. It is a thermal overload 3-pole manual starter for 3-phase circuits. Mounting bracket and flexible cable-covered motor connection cord are furnished.

No. W86 THREE PHASE SWITCH for multiple spindle drill presses, with mounting bracket and connections. Code ZEIKD, wt. 6 lb.

Complete Specifications — Atlas Multiple Spindle Drill Presses

	4	3	2
Number of Spindles	4	3	2
Center to Center of Spindles	13"	18"	15"
Maximum Distance, Table to Jacobs Chucks	26"	26"	26"
Maximum Distance, Table to No. 1 Morse Taper Spindles	24 1/4"	24 1/4"	24 1/4"
Column to Center of Spindle	7 1/2"	7 1/2"	7 1/2"
Column Support Bracket to Center of Spindle	6 7/8"	6 7/8"	6 7/8"
Chuck Capacity	1/2"	1/2"	1/2"
Spindle Travel	4"	4"	4"
Table Working Surface	21" x 54"	21" x 54"	21" x 30"
9 Speeds between	600 and 5200 RPM	600 and 5200 RPM	600 and 5200 RPM
Ground Steel Columns	2 3/4" diam.	2 3/4" diam.	2 3/4" diam.
Overall Height	79 1/2"	79 1/2"	79 1/2"
Overall Depth with Motors	31 1/4"	31 1/4"	31 1/4"
Overall Width	58"	58"	34"
Floor to Top of Table	32"	32"	32"
Wood Shelf	14" x 57 1/4"	14" x 57 1/4"	14" x 33 1/4"
Net Weight less Motors	1040 lb.	960 lb.	735 lb.
Shipping Weight (Approximate)	1280 lb.	1200 lb.	820 lb.
ORDER NUMBER with Jacobs No. 70 to 1/2" Chucks	W84	W83	W82
Code Word with Jacobs No. 70 to 1/2" Chucks, less motors	ZAJUZ	ZAJTA	ZAJJOY
ORDER NUMBER with No. 1 Morse Taper Spindles	W84-1M	W83-1M	W82-1M
Code Word with No. 1 Morse Taper Spindles in place of Chucks, less motors	ZAKAV	ZAJYO	ZAJVE

Atlas COOLANT SYSTEMS (COLUMN DIAMETERS TO 4 1/2 INCHES)

COOLANT SYSTEMS FOR SINGLE SPINDLE DRILL PRESSES

Atlas coolant systems help meet peak production demands, reduce tool wear, and improve work finish. These modern centrifugal-type pumps are engineered for continuous service with any cutting fluid. They are efficient, compact and portable, and are easily adapted to almost any machine tool.

Two coolant Systems are available for single spindle drill presses. No. 110 pumps to 225 GPH. No. 113, offering extra flood-washing capacity, pumps to 450 GPH. Each is equipped with easily installed feed and return unit having plastic lines, universal-type support collar, handy control valve and flexible metal outlet tubing. Complete specifications are listed below. Oil pans recommended for bench and floor type presses are also described below.

No. W110 Coolant System for **Single Spindle Drill Presses**. Complete with induction-type pump and feed and return system. Pumping capacity 225 GPH. Tank has 2 1/2-gallon capacity, measures 12 1/8" x 12 3/8" x 4 1/4" deep. Motor is 3450 RPM induction-type for 110-120 volt, 50-60 cycle, AC. Code ZEKUG, wt. 20 1/2 lb.....

No. W113 Coolant System for **Single Spindle Drill Presses**. Complete with universal-type pump and feed and return system. Pumping capacity 450 GPH. Five-gallon tank measures 14 1/8" x 20 3/8" x 4 1/4" deep. Universal motor — 6000 RPM, 110-120 volt, AC-DC. Code ZELDE, wt. 28 lb.....

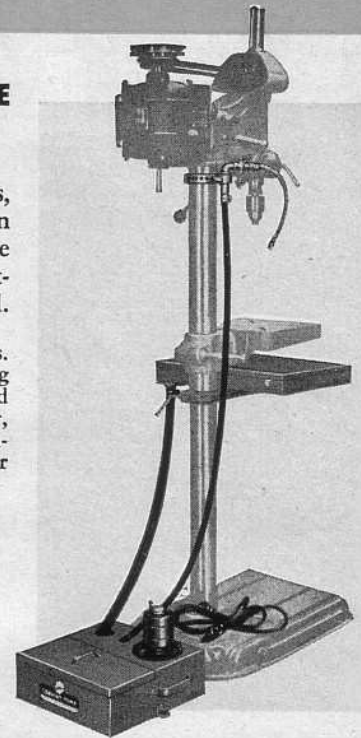
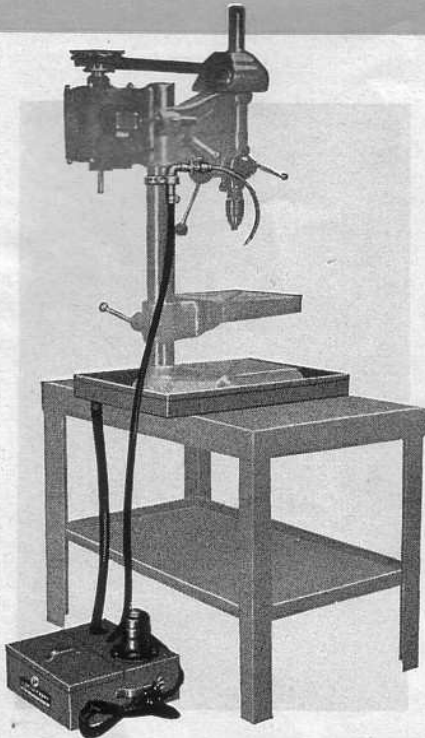

No. W90 Oil pan accommodates most bench-type drill presses. Heavy-gauge steel, leakproof-welded, outlet nipple for return hose. Size: 16" x 22" x 2" deep. Code ZEKBA, wt. 10 lb.....

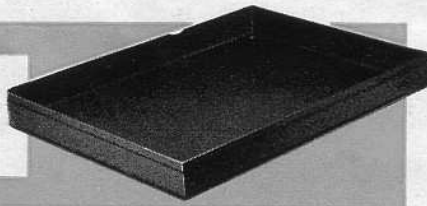

No. W91 Oil pan is designed for 73-series drill presses and others with 2 3/4" diameter columns. Heavy-gauge steel, leakproof-welded, outlet nipple for return hose. Adjustable bracket supports pan on column. Size: 13" x 16" x 2" deep. Code ZEKCE, wt. 12 lb.....



COOLANT SYSTEMS FOR MULTIPLE SPINDLE DRILL PRESSES

Atlas Nos. W116, W117 and W118 coolant systems provide excellent units for two-, three- and four-spindle drilling machines. The extra capacity of the universal-type pump furnished with each is adequate to deliver full volume and pressure to all outlets simultaneously. Each has easily installed feed and return system complete with manifold pipe, plastic lines, column support collars, handy control valves, flexible metal outlet tubing and nozzles. Control valves may be adjusted independently from drip to full flow and all valves may be closed completely while pump is operating without injury to system. Specifications for multiple spindle coolant systems are listed below.

No. W116 Coolant System for **Two-Spindle Drill Presses**. Code ZELJY, wt. 32 lb.....

No. W117 Coolant System for **Three-Spindle Drill Presses**. Code ZELOG, wt. 34 1/2 lb.....

No. W118 Coolant System for **Four-Spindle Drill Presses**. Code ZELUH, wt. 36 1/2 lb.....

Each system is complete with universal-type pump and feed and return unit. Specifications: pumping capacity 450 GPH; tank capacity 5 gallons; tank size 14 1/8" x 20 3/8" x 4 1/4"; universal motor — 6000 RPM, 110-120 volt, AC-DC.

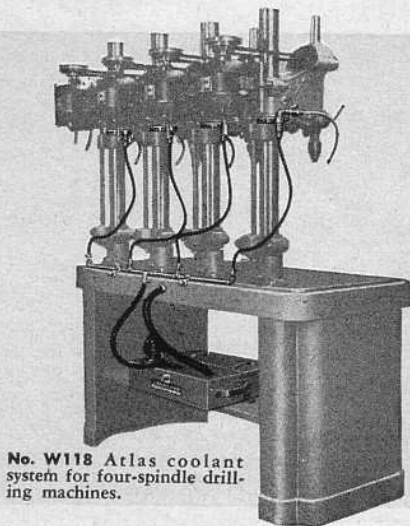

No. W118 Atlas coolant system for four-spindle drilling machines.

Atlas coolant pumps may be purchased without feed and return systems. These versatile units can be easily installed for efficient operation with almost any machine tool. No. W88 has induction-type motor delivering cutting fluid from 2 1/2-gallon tank up to 225 GPH. No. W89 has extra flood washing capacity — powerful universal motor delivers cutting fluid from five-gallon tank up to 450 GPH. Table at right shows rates under varying conditions, fluids. For complete information write for Coolant Pump Catalog No. C43.

PUMPING CAPACITIES

Motor	Outlet Elevation Above Motor	Gallons per Hour	
		Soluble Oil (50% Solution)	Lard Oil (70° F.)
Uni- versal	Level	450	150
	1 ft.	360	108
	2 ft.	300	90
	3 ft.	252	66
	4 ft.	240	60
Induc- tion	5 ft.	216	54
	Level	225	90
	1 ft.	198	78
	2 ft.	180	54
	3 ft.	162	38
	4 ft.	126	23
	5 ft.	114	10

Atlas

DRILL PRESS HEADS

SIMPLIFY
DRILLING
PROBLEMS

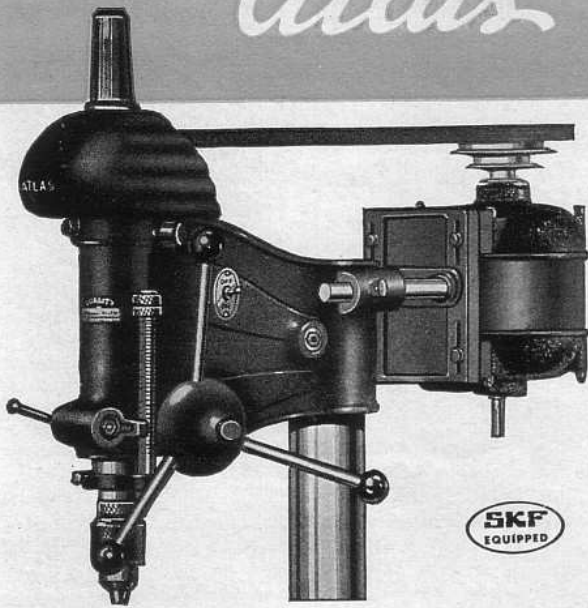

The installations pictured on this page are typical of hundreds where Atlas drill press heads have solved difficult production set-ups. They show how expensive, awkward jobs can be simply converted into profitable operations. The possibilities for multiplying drilling efficiency with these heads are practically unlimited.

Atlas drilling heads often eliminate the need for a costly special drilling machine or intricate fixture. They are compact, portable, easily adapted to the job, and may be operated in any position. Atlas SKF ball bearing spindle-head design insures long, accurate service at high speeds. Their cost is a small fraction of special drilling units, and the 1/2 or 1/3 HP motor requirement keeps operating expense at a minimum.

Atlas drilling heads are available in two sizes: the 15" 63-Series and 12 3/4" 53-Series — complete specifications below. Note: *We do not manufacture special drilling machines.*

SPECIFICATIONS

	63 Series	53 Series
Drills to Center of Circle.....	15"	12 3/4"
Spindle Travel.....	4"	3"
Column Bore.....	2 3/4"	2 1/4"
Chuck Capacity.....	1/2"	1/2"
Speed Range.....	600-5200 RPM	600-5200 RPM
Number SKF Ball Bearings.....	4	3

FURNISHED: Complete as shown with motor mounting bracket, belt and pulley; less motor and column. Motor control switch furnished is 10 ampere at 110 volt single phase only — three phase switch, page 8. Motor pulley furnished is for 1/2" diameter motor shaft — prices of pulleys for other motor shafts on request.

No.	Series	With	Bearing Design	Code	Weight
63-1V	63	No. 70 to 1/2" Jacobs Chuck	Page 5	ZAHET	70 lb.
63-1Z	63	No. 1 Morse Taper	Page 5	ZAHUX	70 lb.
53-1X	53	No. 70 to 1/2" Jacobs Chuck	Page 9	ZEYAP	55 lb.

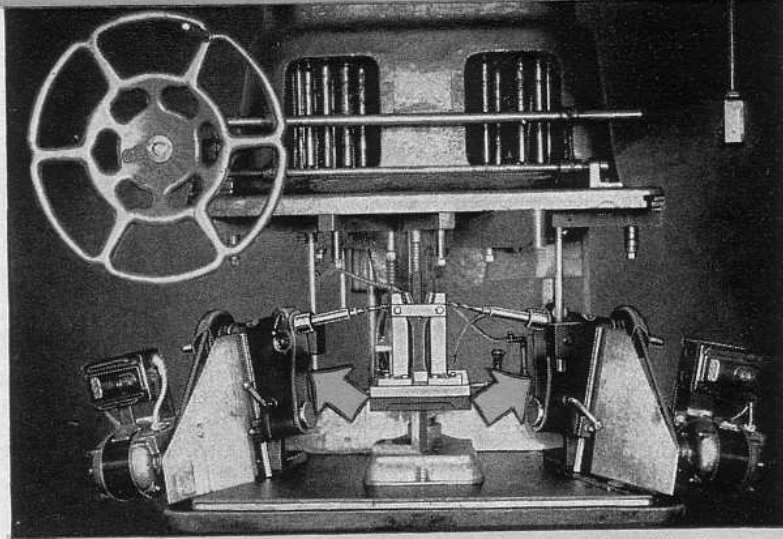

Two 63-series Atlas drilling heads teamed up with multiple spindle drill. Bracket being drilled requires five holes, two of them at an angle to both vertical and horizontal planes. Universal angle bracket holds each head in position — rams attached to multiple spindle head automatically actuate the angular feeds. Drilling time has been reduced by more than 60 per cent — and the cost of a special drilling machine is eliminated.

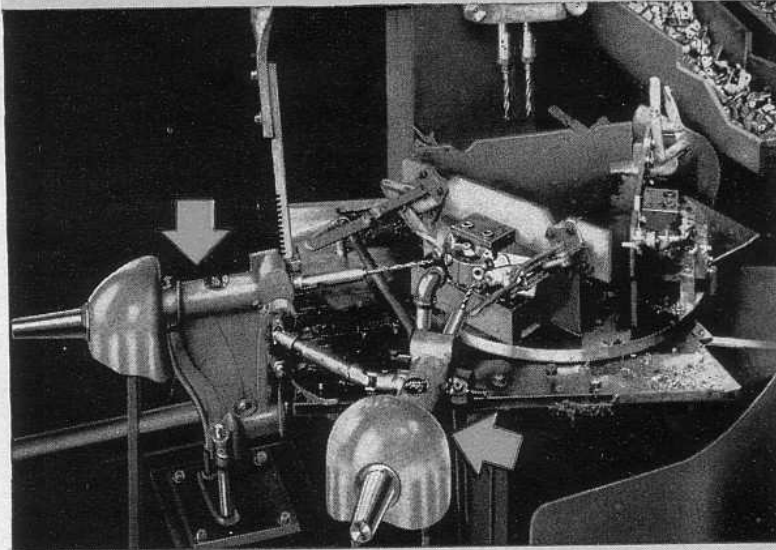

These two 63-series Atlas drill heads gave production a big boost by drilling two extra holes at an extremely low set-up cost. The feed of the vertical drill, carrying a double-spindle drill head for two vertical holes, also drives feed for the two Atlas heads drilling the horizontal holes. Three fixtures on rotary table permit loading parts at one station while two holes are being drilled at each of other two stations.

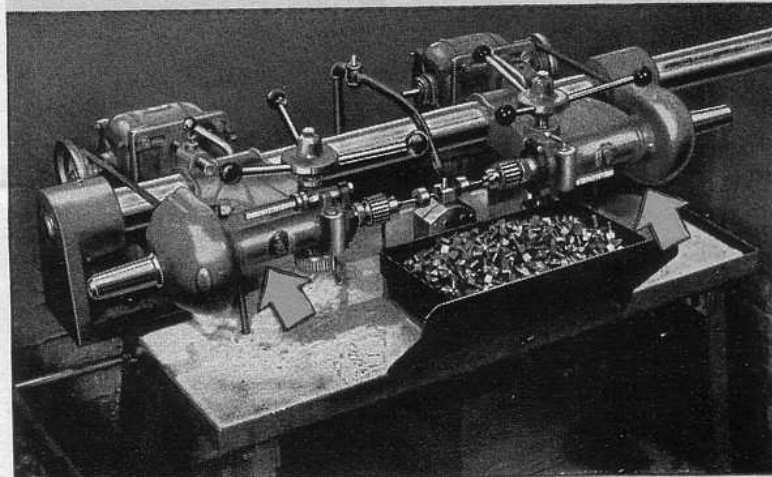

This ingenious drilling set-up multiplies production of a special bolt by simplifying operations from two directions. The two 63-series Atlas drill press heads are mounted horizontally on one column with height adjustments. The piece is first cross-drilled from the right, and the drill carries a tool which counterbores a radius as the hole is completed. Then the piece is counterbored from the left by the second drilling head.

ACCESSORIES AND FOR ATLAS



For ANY GRINDER
AND WHEEL
THICKNESS

CAPACITY
3/32" to 1/2"

No.
W30

DRILL GRINDING ATTACHMENT

Fast, clean, accurate drilling is an easy job when the drill point has been sharpened on the Atlas drill grinder. This attachment soon pays for itself by resharpening drills quickly and accurately, with none of the uncertainty and waste of hand work.

It takes just two minutes to sharpen any drill between 3/32" and 1/2" in diameter, and *both lips are always ground identically*, insuring maximum accuracy and prolonging drill life. Novel chuck and V-block center the drill—shank stop, micrometer graduated feed, and special lip stop assure accurate rechucking for grinding second lip. Radial movement of chuck provides scientific lip clearance. Swivel base allows wide range: 40° to 80° (80° to 160° included angle)—59° and 41° positions are indicated. Easily adaptable to any grinder and any wheel thickness. Overall length from face of wheel 11".

No. W30 DRILL GRINDING ATTACHMENT
complete as shown above. Code WUVNE, wt. 7 lb

Atlas GRINDERS

Rugged, powerful, fast and smooth-running—the Atlas heavy-duty grinders are ideal for grinding tool bits, offhand grinding and snagging, buffing and polishing. Powered by 3450 RPM ball bearing motors, enclosed type. Shaft turns on large SKF ball bearings. All Atlas grinders are equipped with adjustable safety wheel guards and work rests. Floor pedestals and eye-shields are available.

The No. W30 drill grinding attachment (above) converts the Atlas grinder into an accurate, efficient drill grinding machine. Atlas grinders are completely described in Bulletin G1 (condensed specifications below).

No.	HP	Phase	Volt	Cycle	Wt.	Code
2500	3/8	Single	110	50-60	72	WYLEM
2570	1/2	Single	110	50-60	100	WYLLA
2575B	3/4	Three	220	50-60	100	WYMMMA

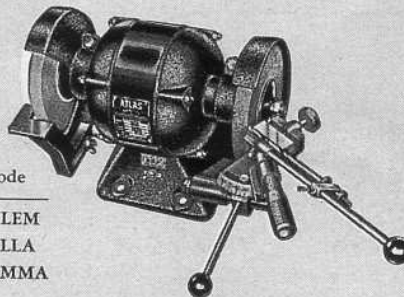

HI-LO SPEED ATTACHMENT

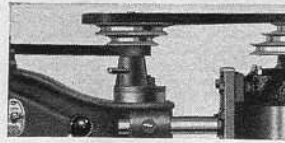

U. S. Patent 2073704



The "Hi-Lo" provides a low speed of 200 RPM for heavy metal work and higher than standard speeds for woodworking. The "Hi-Lo" can be mounted or removed in less than three minutes. Base is accurately machined to fit inside the top of drill press column. Pulley is balanced and runs on a large double-row SKF ball bearing—pulley is mounted eccentric with base, permitting quick release of belt tension for speed changes.

Order No.	Atlas Drill Press	Column Size Inside Diameter	Code Word
W-14B	53-Series	2"	ZEKFO
W-15	60 and 70-Series	2 1/2"	ZAFTO

Low Speed 200 RPM
Weight 6 lb.—V-belts furnished.

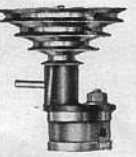

THE PROPERLY GROUND DRILL

As Sharpened with the No. W30 Attachment

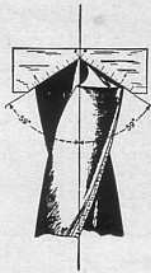

LIPS IDENTICAL

A drill point with both lips ground identically. Lips are of equal length, clearance and angle—the resulting hole will be exactly the proper size. In addition, the properly ground drill will outlast the one with a poorly ground point.

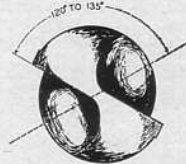

PROPER ANGLE BETWEEN POINT AND LIP

A view directly into the drill point showing the proper angle between point and lip. This angle must be between 120° and 135° in order to provide correct lip clearance at the center of the drill.

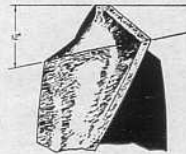

PROPER LIP CLEARANCE

Another view of the point showing the proper lip clearance at the circumference of the drill. For correct drilling, this angle must be between 12° and 15°. Too much clearance makes a weak point resulting in rapid wear and chipping—too little clearance makes the drill cut slowly, requiring greater power.



DIAMOND POINT FOR DRESSING WHEEL

No. W30-35A DIAMOND POINT. Held in chuck of drill grinding attachment. Code ZEERK, wt. 4 ozs.

RECESS WHEELS

For Drill Grinding
Recessed One Side

No. W30-40
Diameter6"
Diam. Hole3/4"
CodeWUVSY
Weight2 lb.

No. W30-41
Diameter7"
Diam. Hole5/8"
CodeWUVUR
Weight2 1/2 lb.



ATTACHMENTS

DRILL PRESSES

DRILL PRESS VISE

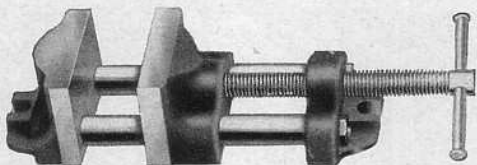

Iron jaws are $2\frac{5}{8}$ " wide and open to $3\frac{1}{8}$ "; jaw height over guide rods $1\frac{1}{8}$ ". Steel guide rods keep jaws in accurate alignment and form level work support—base casting is accurately machined. Ample clearance height is provided so that drill point will not gouge table when breaking through. Recesses permit clamping vise.

No. W8 DRILL PRESS VISE as shown above. Code word ZADPA, wt. 5 lb.

No. W8V V-BLOCK JAW for holding round work in drill press vise. Code ZADSO, wt. 10 oz.

No. W8S SWIVEL JAW for holding tapered and irregular work. Code ZADUT, wt. 8 oz.

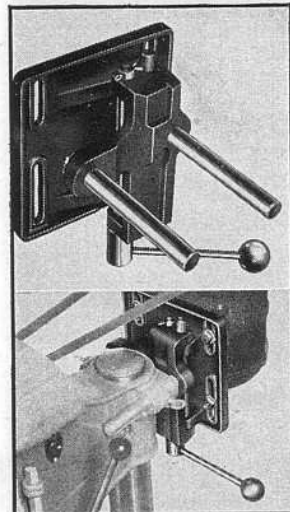
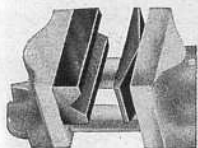

QUICK-CHANGE BELT RELEASE

Speeds up belt changes. Handle brings motor toward drill press head, releasing belt tension instantly.

Easily installed, replacing standard motor bracket. Position of hinged motor base is shifted by hardened rocker-shaft with ball handle control, assuring correct belt tension at all times.

QUICK CHANGE RELEASE ordered with No. 63 or 73 drill press. Extra.

No. 52-50A QUICK CHANGE RELEASE for 60- and 70-Series drill presses, ordered separately. V-belt furnished. Code ZECWO, wt. $12\frac{1}{2}$ lb.

DRILL PRESS LAMP

15-inch flexible cable, universal mounting bracket with clamp screws, fits almost any make drill press, satin-chrome finish, "push-thru" switch.

No. W38 DRILL PRESS LAMP with mounting bracket, 6 ft. rubber cord, switch, plug. Code ZAFUV, 2 lb.

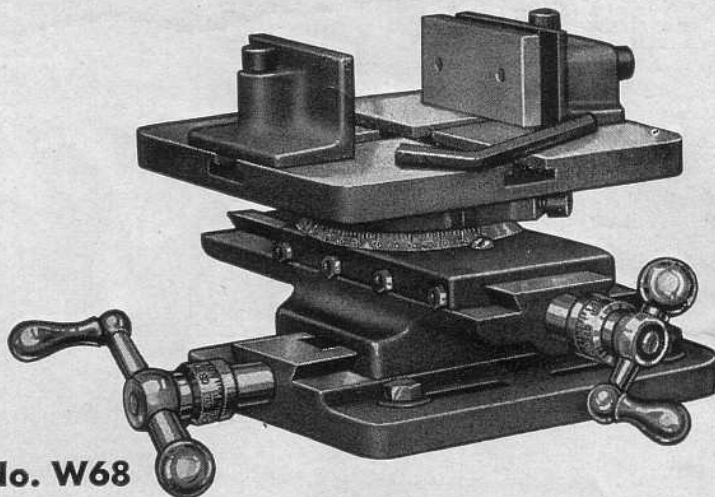

No. W68

UNIVERSAL COMPOUND VISE

This versatile fixture handles all types of accurate indexing, layout, and spacing work — straight lines, radial, circular — and is built rigidly to permit adapting drill presses to light milling operations. It can also be used with shaper, milling machine, lathe, and grinder for any jobs which require accurate feeds in two directions.

The rugged base casting is a rigid accurate foundation for the entire attachment—bottom is machine-ground. Four flanged slots permit bolting or clamping to the drill press table or base. Upper slide is graduated through 180° (90° right and left) so that the vise table may be rotated to any angle and set accurately. The transverse (upper) and cross (lower) slides travel on dovetail ways, carefully machined and hand-fitted — full-length gib plates with screws and lock nuts provide means for take-up. Feed screws have Acme threads, ball crank controls with take-up, and steel collars graduated in thousandths.

The machine-ground table casting is locked to the upper slide by two socket-head cap screws. Four T-slots for positioning and locking vise jaws extend from center of table to edges. Each vise jaw is locked by a socket-head cap screw. One jaw can be swiveled to grip irregular work — the other has a movable face which is tightened upon the work after both jaws have been clamped to the table. Table can be used alone to hold long work for boring on Atlas 10-inch lathes, replacing the lathe compound rest.

No. W68 UNIVERSAL COMPOUND VISE complete as shown above with wrench and bolts. Code ZEFWE, wt. $23\frac{3}{4}$ lb.

SPECIFICATIONS

Cross Feed Travel (lower)	$6\frac{1}{2}$ "	Size of Table	$7" \times 7"$
Transverse Feed Travel (upper)	$5\frac{1}{2}$ "	Jaw Width	$3"$
Size of Base	$6" \times 7"$	Jaw Opening	$4\frac{5}{8}"$
		Jaw Height	$1\frac{5}{8}"$
		Height: Base to Table	$4\frac{1}{4}"$

No. W68-2A TABLE ONLY for boring on Atlas 10" lathes, complete with vise and wrench. Code ZEFZO, wt. 12 lbs.

No. W8V V-BLOCK JAW for holding round work in vise jaws. Code ZADSO, wt. 10 oz.

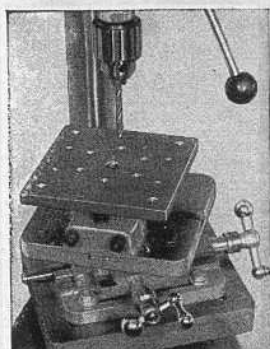

Typical spacing job for the W68 vise — drilling holes at 60° intervals around center of drill jig.

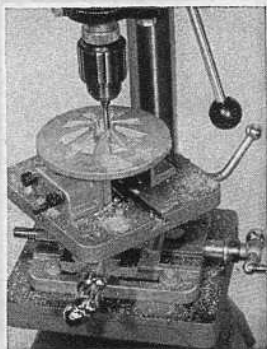

The W68 Vise simplifies many jobs in the pattern shop. Above, routing angular slots.

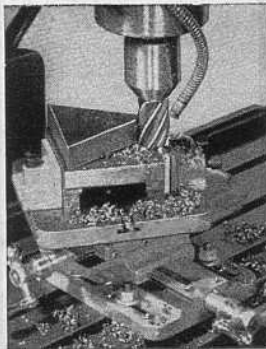

Machining triangular punch press die on milling machine with vise table at 60° .

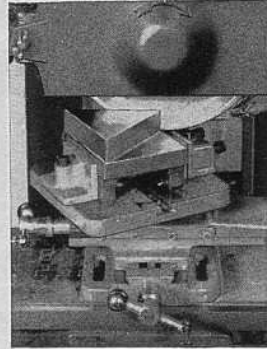

Magnetic chuck of grinder holds W68 vise while sides of triangular die are finish-ground.



Vise table alone (No. W68-2A) holding long piece for boring in Atlas 10" lathe.

ATTACHMENTS for *Atlas* DRILL PRESSES

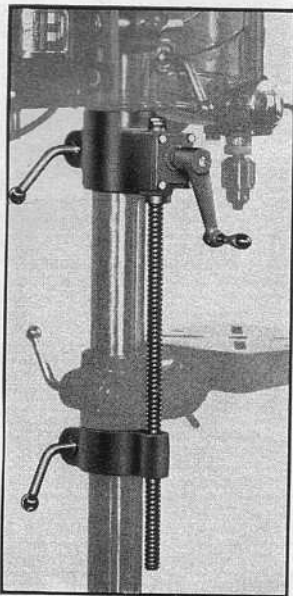

U. S. Patent 2260635

HEAD and TABLE POSITIONING MECHANISM

For 60- and 70-Series Drill Presses

No. W76 positioning mechanism mounted on column of No. 73 drill press. Notice convenient location of crank handle.

This time saver with its handy crank control makes fast, easy work of raising or lowering the drill press head or table. It can be quickly installed on any Atlas 60- or 70-Series drill press.

The W76 mechanism consists of support collars for the drill head and table, positioned by an acme-thread lift screw with bevel-gear drive controlled by the crank handle. Both support collars are equipped with coordinate clamp locks. When the head support collar is tightened, the lower collar may be loosened for raising or lowering the table. In a similar manner, the table collar when tightened serves as a support for positioning drill press head.

One revolution of the crank gives $\frac{1}{8}$ " travel — maximum travel at one setting is 12". Two bevel gears, thrust bearing and crankshaft are housed in the gear case cast integrally with the upper support collar. Ball thrust bearing takes load on screw, so that crank handle turns freely.

No. W76 HEAD AND TABLE POSITIONING MECHANISM for 60- and 70-Series drill presses. Code ZAIRG, wt. 18 lb.....

RADIAL ARM INCREASES THROAT CAPACITY TO 24"

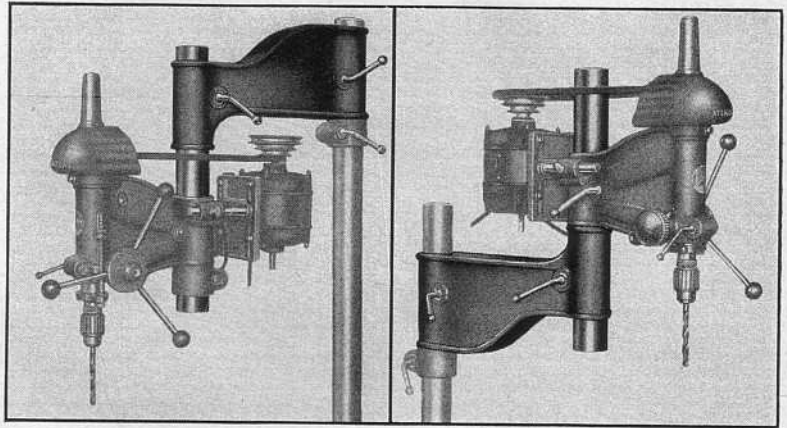

Converts any Atlas 60- or 70-Series drill press into a small radial drilling machine. Increases chuck-to-column capacity to a full 24", and the auxiliary column furnished adds 15" to chuck-to-base capacity.

Massive arm casting is ribbed and reinforced to maintain rigidity. Holes for drill press column and auxiliary column are precision bored. Arm has 8" bearing on drill press column and 7" bearing on auxiliary column. 19" auxiliary column is $2\frac{3}{4}$ " diameter, allows travel of the drill head up to $6\frac{1}{2}$ " — also permits drill head to be mounted above or below arm.

No. W79 RADIAL ARM for 60- and 70-Series drill presses. Code word ZAJAT, wt. 46 lb.....

No. 61-75A COLUMN COLLAR for supporting drill head on auxiliary column with radial arm inverted. Code ZEHYA, wt. $3\frac{1}{2}$ lb.....

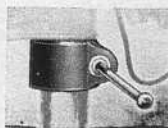

COLUMN COLLAR

Simplifies raising and lowering drill press head and permits swinging head. Furnished with Nos. 63 and 73 drill presses.

No.	Drill Press	Weight	Code
61-75A	63 or 73	$3\frac{1}{2}$ lb.	ZEHYA
52-75B	53	$3\frac{1}{2}$ lb.	ZEHZE

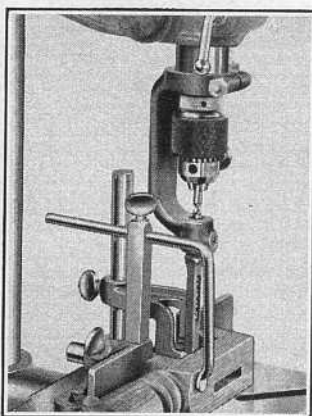

MORTISING ATTACHMENT

Converts any Atlas drill press into a mortising machine for cutting clean, accurate mortise-and-tenon joints. Saves time and gives a much closer fitting joint than is possible by hand methods — essential for joint work on such projects as tables, chairs, bookcases, cabinets and window screens.

The fence may be adjusted after table bracket has been bolted to drill press table — an exclusive feature. This permits adjusting work so that mortises larger than the regular range of a chisel may be cut accurately. Fence always moves absolutely parallel to sides of chisel.

Hold-down foot is quickly adjustable for work between $\frac{1}{2}$ " and 6" high. Capacity between fence and side-clamp arm is $5\frac{1}{2}$ ". Clamp arm may be turned out of the way for wider work.

No. W1B MORTISING ATTACHMENT complete as shown including chisel socket, hold down foot, fence and side clamp arm. Code ZALWA, wt. 10 lb.....

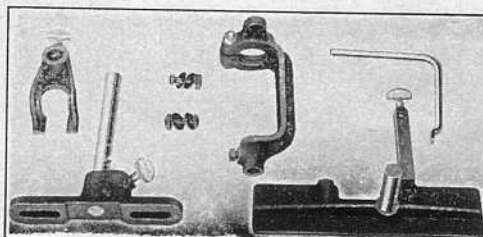

PROFESSIONAL MORTISING CHISELS



Select high-carbon steel, carefully heat-treated. Have long life and superior cutting qualities. Weight 4 oz. each.

No.	Size	Depth of Mortise	Code
W1-16P	$\frac{1}{4}$ " x $\frac{1}{4}$ "	$1\frac{7}{8}$ "	ZAMEZ
W1-17P	$\frac{3}{8}$ " x $\frac{3}{8}$ "	$3\frac{1}{4}$ "	ZAMBIB
W1-18P	$\frac{1}{2}$ " x $\frac{1}{2}$ "	$3\frac{3}{4}$ "	ZAMOC

MORTISING CHISEL BITS



Special alloy steel carefully heat treated. Held in drill press chuck — no special bushings or adapters required. Wt. 3 oz. each.

No.	Size	Diameter Shank	Code
W1-19	$\frac{1}{4}$ "	$3/16$ "	ZANAZ
W1-20	$\frac{3}{8}$ "	$19/64$ "	ZANBE
W1-21	$\frac{1}{2}$ "	$19/64$ "	ZANDO

Atlas HEAVY DUTY MOTORS

1/3, 1/2 AND 3/4 HP MOTORS

It's cheaper to buy a dependable Atlas motor — you will be sure to get exceptional power, smooth, cool, quiet operation, low power cost, and long service life.

Atlas motors are designed and built to meet the rigid specifications demanded by Atlas engineers. Windings are well-insulated and protected for durability — careful provision is made for thorough ventilation — rotor is statically and

dynamically balanced. Atlas motors have large SKF bearings — may be used in any position, horizontal, vertical, or inverted.

Before shipment Atlas motors must pass thorough factory tests for full-rated horsepower, electrical characteristics, and satisfactory mechanical conditions. No expense is spared to supply a truly superior, modern motor.

SINGLE PHASE CAPACITOR START MOTORS

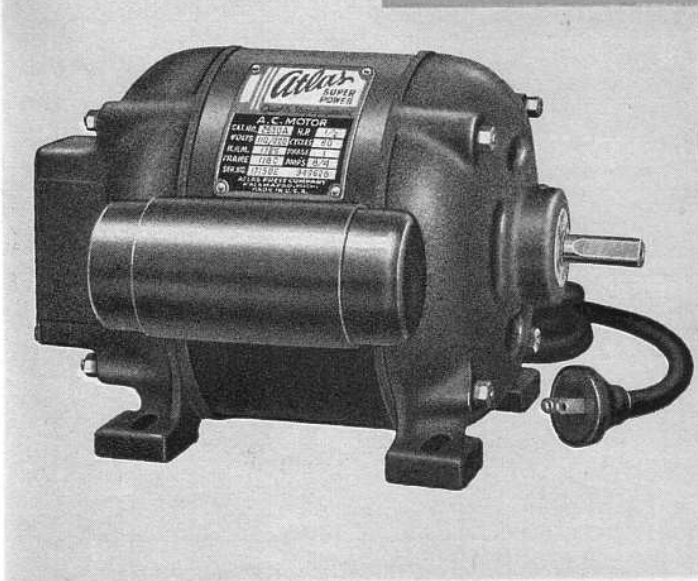

COMPLETE SPECIFICATIONS

Order No.	Code	Horse Power	RPM	Shaft	Weight
2520B	ZEWOR	1/3	1725	1/2" Single-end	33 lb.
2530A	WYZIC	1/2	1725	1/2" Single-end	40 lb.
2540B	ZEELD	1/2	3450	1/2" Double-end	40 lb.
2550B	ZEEMF	3/4	3450	5/8" Single-end	45 lb.

Specifications for all motors listed above

Voltage110-220
 Phase, type.....Single phase, capacitor start
 Cycle60
 Bearings.....SKF ball bearings
 Cord and plug.....10 ft. approved SJ extension cord and plug

Do not have switch.

THREE PHASE MOTORS

COMPLETE SPECIFICATIONS

Order No.	Code	Horse Power	Voltage	RPM	Weight
2620	ZEWRO	1/2	220	1725	35 lb.
2630	ZEWPE	1/3	220	1725	28 lb.
2625	ZEWUS	1/2	440	1725	35 lb.
2635	ZEWYT	1/3	440	1725	30 lb.

Specifications for all motors listed above

Shaft.....1/2" single-end
 Phase, type.....three
 Cycle60
 Connector.....BX Connector in terminal box
 Bearings.....SKF ball bearings

Do not have switch, cord or plug.



MOTOR RECOMMENDATIONS — SWITCHES

	AVERAGE DUTY	HEAVY DUTY
F-SERIES 10-INCH LATHES.....	Use No. 2520B 1/3 HP motor — No. 2630 or 2635 3-phase motor	Use No. 2530A 1/2 HP motor — No. 2620 or 2625 3-phase motor
DRILL PRESSES.....	Use No. 2520B 1/3 HP motor — No. 2630 or 2635 3-phase motor	Use No. 2530A 1/2 HP motor — No. 2620 or 2625 3-phase motor
No. 618 SIX-INCH LATHES.....	Use No. 2520B 1/3 HP motor, or No. 2630 or 2635 three-phase motor	
Nos. M1B, MFB, AND MHB MILLING MACHINES.....	Use No. 2520B 1/3 HP motor, or No. 2630 or 2635 three-phase motor	
No. 7B SHAPER.....	Use No. 2530A 1/2 HP motor, or No. 2620 or 2625 three-phase motor	
No. S8ES TILTARBOR SAW.....	Use No. 2540B 1/2 HP motor	Use No. 2550B 3/4 HP motor
No. S10ES TILTARBOR SAW.....	Use No. 2550B 3/4 HP motor	Use No. 2550B 3/4 HP motor

REVERSING SWITCHES FOR *Atlas* LATHES



The No. 420HD Reversing Switch for Atlas 10" lathes is a heavy duty 1 HP drum-type switch for voltage up to 600 AC. Recommended for any operation requiring constant reversing of motor. Has large diameter arc shields, snappy star wheel indexing, forged copper-tipped fingers. Operates on single phase, capacitor, and 3-lead repulsion-induction motors (not 4-lead) — also both shunt-wound and compound-wound DC. Mounts on reverse gear box, a handy, easy-to-reach position.

The No. 10-420 Reversing Switch for Atlas 10" lathes is excellent for average duty but is not recommended where operations require constant reversing of motor. This drum-type switch has a knobbed lever control that is easily shifted to forward, off, or reverse position. Durable contacts are hard rolled copper. Operates on single phase, capacitor and 3-lead repulsion-induction motors (not 4-lead) — also shunt and compound-wound DC. Mounts on reverse gear box.



No. 420HD HEAVY-DUTY REVERSING SWITCH complete with mounting bracket, 6 ft. heavy cord and plug, installation diagram. Code word YICAD, weight 3 1/2 lb.....

The No. 420D Reversing Switch for Atlas 10" lathes is designed for three phase current. It is a heavy-duty 1 HP drum-type switch for voltages up to 440 AC. Recommended for any operation requiring constant reversing of motor. Has knobbed lever control easily shifted to forward, off or reverse position, heavy contacts of hard rolled copper. Mounts on reverse gear box.

No. 420D THREE-PHASE REVERSING SWITCH complete with mounting bracket, cable connections, and installation diagram. Code word YEMYP, weight 4 lb.....

No. 10-420 REVERSING SWITCH complete with mounting bracket, cable connections, installation diagram. Code word YELJE, wt. 3 1/2 lb.....

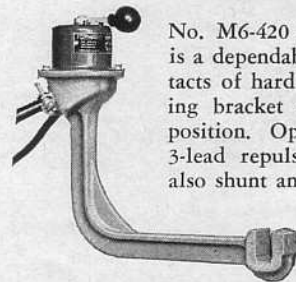

No. M6-420 Reversing Switch for Atlas 6" lathes is a dependable drum-type switch with durable contacts of hard rolled copper; furnished with mounting bracket which places control lever in handy position. Operates on single phase, capacitor and 3-lead repulsion-induction motors (not 4-lead) — also shunt and compound-wound DC.

No. M6-420 REVERSING SWITCH complete with mounting bracket, cable connections, installation diagram. Code word YEYOY, wt. 5 lb.....

THREE PHASE MOTOR CONTROL SWITCHES



These thermal overload 3-pole manual starter switches are required for 3-phase circuits. Have positive make and quick break mechanism — twin break silver contacts that give less arcing, increased life and better contact. Overload trip indication reset by pushing reset button. All metal parts are protected against rust. Bracket for bench mounting and flexible cable-covered motor cord furnished. Wt. 6 lbs. Details at right.

No.	For	Code
S7-300	Lathes	ZEBAR
W67	Drill Presses	ZECET
W86	Drill Presses (multiple spindle)	ZEIKD
S7-300	Shaper	ZEBAR
S7-300	Milling Machine	ZEBAR
S7-300	2575B Grinder	ZEBAR

Atlas HEAVY DUTY GRINDERS

1/3 AND 1/2 HP—3450 RPM BALL BEARING MOTOR

Rugged, powerful, fast, smooth-running — these Atlas grinders meet every need of the modern shop. They are built around a 3450 RPM cool-running ball bearing motor with precision balanced rotor. Shaft turns on oversized SKF ball bearings, sealed against wheel dust. The motors of the 1/3 and 1/2 HP grinders are completely enclosed. One wheel is for roughing, the other for finishing. All grinders are

equipped with adjustable work rests and adjustable safety wheel guards.

Atlas grinders can be equipped with floor pedestal and eye-shields — details are given below. The No. W30 drill grinding attachment (below) converts the Atlas grinder into an accurate, efficient drill grinding machine.

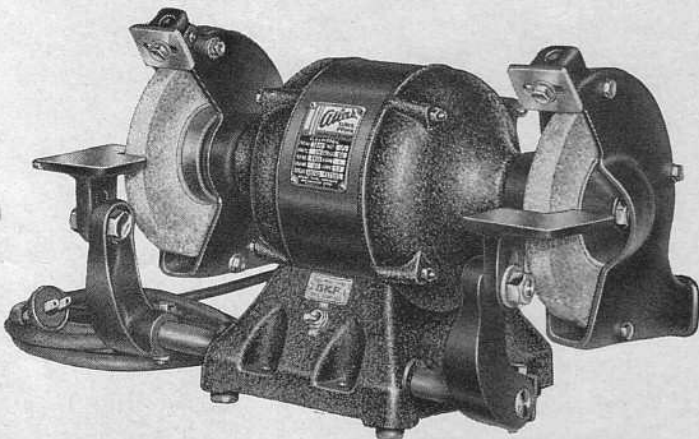

1/3 AND 1/2 HP GRINDERS

1/3 HP SINGLE PHASE 110 VOLT GRINDER

No. 2500 1/3 HP BENCH GRINDER—6" wheels (3/4" thick), 1/2" shaft. Overall: 18" x 10" x 11" high. MOTOR: Single phase, 110 volt 50-60 cycle, 3450 RPM. SKF ball bearings, built-in switch, cord and plug. Code word WYLEM, weight 72 lb.....

1/2 HP SINGLE PHASE 110 VOLT GRINDER

No. 2570 1/2 HP BENCH GRINDER—7" wheels (1" thick), 5/8" shaft. Overall: 20 1/2" x 11 1/2" x 12" high. MOTOR: Single phase full capacitor, 110 volt, 50-60 cycle, 3450 RPM. SKF ball bearings, built-in switch, cord and plug. Code WYLLA, weight 100 lb.....

1/2 HP THREE PHASE 220 VOLT GRINDER

No. 2575B 1/2 HP THREE PHASE BENCH GRINDER—7" wheels (1" thick), 5/8" shaft. Overall: 20 1/2" x 11 1/2" x 12" high. MOTOR: 3 phase, 220 volt, 50-60 cycle, 3450 RPM. SKF ball bearings, BX connector in terminal box. Code word WYMMA, weight 100 lbs.....

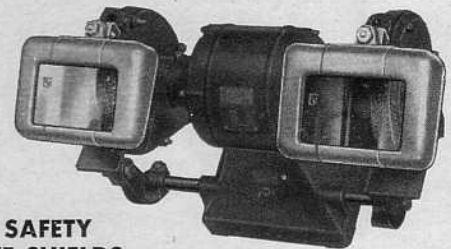

SAFETY EYE SHIELDS

Special shatterproof glass protects operator's vision as required by industrial and vocational safety codes. Mounted on wheel guards.

No. W37-5B SAFETY EYESHIELDS for 1/3 and 1/2 HP grinders. (Give year purchased.) Code word WYMIP, weight 5 lb.....

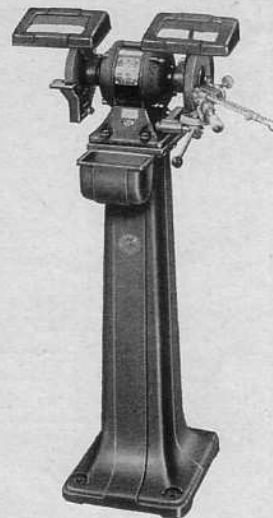

FLOOR PEDESTALS

A rugged floor mounting for grinder. Heavy grey iron casting is scientifically designed and braced for maximum rigidity. Pedestal is 12" wide, 16" deep, 34 1/2" high, overall.

No. W37-1C FLOOR PEDESTAL for 1/3 HP grinders. (Give year purchased.) Complete with grinder table and water pot. ZEEPH, wt. 115 lb.....

No. W37-1B FLOOR PEDESTAL for 1/2 HP grinders, complete with grinder table and water pot. Code WYMAM, wt. 115 lb.....

Atlas DRILL GRINDING ATTACHMENT

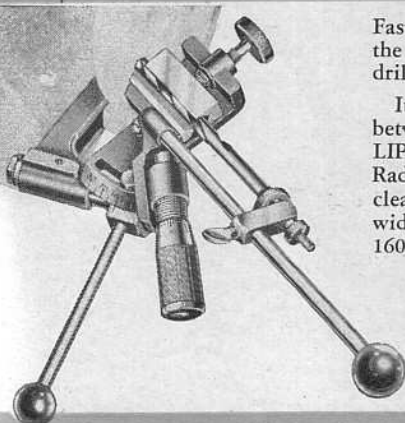

Fast, clean, accurate drilling is an easy job when the drill point has been sharpened on the Atlas drill grinder.

It takes just two minutes to sharpen any drill between 3/32" and 1/2" in diameter, and BOTH LIPS ARE ALWAYS GROUND IDENTICALLY. Radial movement of chuck provides scientific lip clearance. Swivel base allows wide range: 40° to 80° (80° to 160° included angle) — 59° and 41° positions are indicated.

No. W30 DRILL GRINDING ATTACHMENT for any grinder and wheel thickness. Code WUVNE, 7 lb.



DIAMOND POINT

For Dressing Wheel

No. W30-35A DIAMOND POINT. Held in chuck of drill grinding attachment. Code ZEERK, wt. 4 oz.....

RECESS WHEELS

For Drill Grinding Recessed One Side

No. W30-40 RECESS WHEEL. 6" diameter, 1/2" diam. hole. Code WUVSY, 2 lb.....

No. W30-41 RECESS WHEEL. 7" diameter, 5/8" diam. hole. Code WUVUR, 2 1/2 lb.....

INDEX

A ngle plate, 10-inch lathes.....	20
Angle plate, milling machine.....	41
Angle plate, 7-inch shaper.....	32
Angular milling cutters.....	16, 24, 40
Arbor, milling machine.....	40
Arbors, chuck, 10-inch lathes.....	19
Arbors, chuck, 6-inch lathes.....	25
Armature chuck kits, 10-inch lathes.....	21
Armature chuck kits, 6-inch lathes.....	25
Attachments, drill press.....	50, 54, 56-58
Attachments, lathes.....	8-22, 24-26
Attachments, milling machines.....	40-42
Attachments, shaper.....	32

B all bearing lathe centers.....	20, 25
Belt guard, drill press.....	50
Belt guards, lathes.....	18
Belt release, drill press.....	57
Bench grinders.....	61
Boring bars, 10-inch lathes.....	20
Boring table, 10-inch lathes.....	16
Boring tool holder, 10-inch lathes.....	20
Boring tools, lathe.....	21, 25

C abinets, for 10-inch lathes.....	13
Carriage stop, 10-inch lathes.....	15, 21
Carriage stop, 6-inch lathes.....	24
Center ejector bar.....	20, 26
Center rest chuck, 10-inch lathes.....	19
Center rest chuck, 6-inch lathes.....	25
Centers, lathe.....	20, 25
Centers, woodworking lathes.....	26
Chisel bits, mortising.....	58
Chisels, mortising.....	58
Chisels, woodturning.....	26
Chuck kits, armature, 10-inch lathes.....	21
Chuck kits, armature, 6-inch lathes.....	25
Chucks, 10-inch lathes.....	19
Chucks, 6-inch lathes.....	25
Clamping plate, for milling attachment.....	16
Clamp type dog.....	21, 24
Coil winding attachment, lathe.....	21, 26
Collet bushings, for milling operations.....	16, 24
Collet chuck attachments, 10-inch lathes.....	14
Collet chuck attachment, 6-inch lathes.....	25
Column collars, drill press.....	51, 58
Compound vise, for drill presses.....	57
Coolant pumps.....	62
Coolant systems, drill presses.....	54
Coolant systems, lathes.....	22
Coolant systems, milling machines.....	42
Coolant tank, milling machines.....	42
Cross slide stop, 10-inch lathes.....	21
Cross slide stop, 6-inch lathe.....	24
Crotch centers.....	20, 24
Cup centers, woodworking.....	26
Cut-off tool, lathe.....	21, 25
Cutter bits, for 10-inch lathes.....	21
Cutter bits, for 6-inch lathes.....	25
Cutter bits, for 7-inch shaper.....	32
Cutter grinding attachment, lathe.....	17
Cutter holding set.....	16, 24
Cutters, milling, for metal lathes.....	16, 24
Cutters, milling machine.....	40

D iamond point wheel dresser.....	61
Dogs, lathe.....	21, 24
Draw-in collet set, 10-inch lathes.....	14
Draw-in collet set, 6-inch lathes.....	25
Drill chucks, 10-inch lathes.....	19
Drill chucks, 6-inch lathes.....	25
Drill grinding attachment.....	56

Coolant Pumps.....Page	62
Drill Presses.....Pages	43-58
Grinders.....Page	61
Lathes.....Pages	2-26
Milling Machines.....Pages	33-42
Motors.....Pages	59-60
Shapers.....Pages	27-32

Drill pads.....	20, 24
Drill press attachments.....	50-58
Drill presses.....	43-58
Drill presses, multiple spindle.....	53
Drill press heads, for special set-ups.....	55
Drill press lamp.....	57
Drill press vises.....	57

E nd mills.....	16, 24, 40
Extension beds, lathe.....	26
Extension tool, shaper.....	32
Eyeshield, grinder.....	61

F ace plates, 10-inch lathes.....	20, 26
Floor cabinet, milling machine.....	42
Floor grinders.....	61
Floor pedestals, grinders.....	61
Floor stands, cabinets, 10-inch lathes.....	13
Floor stands, 6-inch lathes.....	26
Floor stand, cabinet, shaper.....	32
Follower rest, lathe.....	20, 24
Foot lever feed control, drill press.....	50

G ear cutting attachment, blueprint.....	16
Gear train guards, 10-inch lathe.....	14
Grinders, tool post, 10-inch lathes.....	17
Grinders, bench and floor.....	61
Grinding wheels, drill.....	56
Grinding wheels, tool post grinders.....	17

H andrest, woodworking.....	26
Headstock chucks, 10-inch lathes.....	19
Headstock chucks, 6-inch lathes.....	25
Hi-Lo speed attachments, drill press.....	56

I ndependent chucks, 10-inch lathes.....	19
Independent chucks, 6-inch lathes.....	25
Index centers, milling machine.....	41
Index centers, 7-inch shaper.....	32

J acobs chucks, 10-inch lathes.....	19
Jacobs chucks, 6-inch lathes.....	25

K nurling tool, 10-inch lathes.....	21
Knurling tool, 6-inch lathes.....	25

L amp, drill press.....	57
Lamp, 10-inch lathes.....	20
Lamp, 6-inch lathes.....	26
Lathe attachments, 10-inch.....	8-22
Lathe attachments, 6-inch.....	24-26
Lathe centers.....	20, 24, 25, 26
Lathe manual.....	18
Lathes, 10-inch backgeared with power cross feed.....	2-22
Lathes, 6-inch backgeared.....	23-26

M anual of Lathe Operation.....	18
Mica undercutter, 10-inch lathes.....	21
Mica undercutter, 6-inch lathes.....	26
Mica undercutting saws.....	21, 26
Milling attachment, lathes.....	16, 24
Milling machine.....	33-42
Milling machine, attachments for.....	40-42
Mortising attachments, drill press.....	58
Mortising chisel bits, drill press.....	58
Mortising chisels, drill press.....	58
Motors.....	59-60

O il tables, drill press.....	50
Oil pans, drill press.....	54
Oil pans, lathe.....	22

P edestals, grinder.....	61
Pick-O-Matic change gears, lathe.....	8, 9
Pipe centers, 10-inch lathes.....	20
Positioning mechanism, drill press.....	58

R adial arm, drill press.....	58
Reamer grinding attachment.....	17
Recess wheels, for drill grinding.....	61
Reversing switches.....	13, 17, 24, 60
Rotary index table, milling machine.....	41
Rotary index table, 7-inch shaper.....	32

S aws, undercutting.....	21, 26
Screw centers, woodworking.....	26
Shaper, 7-inch.....	27-32
Shaper, 7-inch, attachments for.....	32
Six-inch lathes, backgeared.....	23-26
Speed attachments, for drill presses.....	56
Spindle nose cap, 10-inch lathe.....	14
Split collets.....	14, 25
Spur centers, woodworking.....	26
Steady rest, lathe.....	20, 24
Switches, reversing.....	13, 17, 24, 60
Switches, three phase.....	13, 32, 42, 60

T aper attachments, 10-inch lathes.....	18
Taper attachment, 6-inch lathe.....	24
Tapping attachments, drill press.....	50
Threading tool, 10-inch lathes.....	21
Threading tool, 6-inch lathe.....	25
Tool bits, 1/4-inch.....	21
Tool bits, 3/16-inch.....	25
Tool holder, shaper.....	32
Tool holders, 10-inch lathes.....	21
Tool holders, 6-inch lathe.....	25
Tool-post grinders, 10-inch lathes.....	17
Tool-post tools, 10-inch lathes.....	21
Tool-post tools, 6-inch lathes.....	25
Turret attachments, 10-inch lathes.....	15
Turret type boring set, 10-inch lathes.....	20

U ndercutter, 10-inch lathes.....	21
Undercutter, 6-inch lathes.....	26
Undercutting saws.....	21, 26
Universal chucks, 10-inch lathes.....	19
Universal chucks, 6-inch lathes.....	25

V alve stem grinding attachment.....	17
Vise, drill press.....	57
Vise, swivel, milling machine.....	41

W heels, drill grinding.....	61
Woodruff keyway cutters.....	16, 24, 40
Woodworking attachments, lathe.....	26

ATLAS PRESS COMPANY

1819-2019 No. Pitcher Street - Kalamazoo 13D, Michigan, U.S.A.

EXPORT DEPARTMENT: 130 West 42nd St., New York City, Cable Address: "APCOY" New York

Atlas

ENGINEERED PRECISION

FOR ALL SHOP NEEDS

Rigorous war production demands for precision and durability have again demonstrated the capabilities of Atlas tools for all kinds of machining operations within their capacities.

TOOL ROOMS find the Atlas 4-Tool Team — lathes, milling machines, shapers, drill presses — ideally suited for all types of special dies, jigs, models, and tools.

PRODUCTION DEPARTMENTS have come through on many a critical contract deadline by using Atlas equipment, often with unique automatic production aids that are readily added to the normal machine functions.

MAINTENANCE DEPARTMENTS solve many of their countless problems by taking full advantage of the wide operating flexibility of Atlas tools.

AUTOMOTIVE SERVICING is greatly speeded up when general service garages employ Atlas lathes and other tools for special operations and making out-of-stock replacement parts.

SCHOOL SHOPS, helped by the low investment and operating costs of Atlas machines, have been able to meet today's demands for broader vocational training.

HOME SHOPS by the thousands have been able to use their pre-war Atlas equipment in valuable subcontract work.

Whatever your machine tool need you can rely on the engineered precision of Atlas tools.

ATLAS PRESS COMPANY

1819-2019 North Pitcher St., Kalamazoo 13D, Michigan, U.S.A.

