

The  Line
PEERLESS

PORTABLE ENGINES

GEISER

SAW MILLS



EMERSON-BRANTINGHAM IMPLEMENT CO.

INCORPORATED

GOOD FARM MACHINERY

ESTABLISHED 1852

ROCKFORD, ILL., U.S.A.

The Line

Peerless Portable Engines Geiser Saw Mills

Manufactured at the
E-B (GEISER WORKS)
Waynesboro, Pa.

Amarillo, Tex.
Billings, Mont.
Dallas, Texas
Denver, Colo.
Des Moines, Ia.

Fargo, N. D.
Harrisburg, Pa.
Indianapolis, Ind.
Kansas City, Mo.
Minneapolis, Minn.

BRANCH HOUSES

Nashville, Tenn.
Oklahoma City, Okla.
Omaha, Nebr.
Peoria, Ill.
Columbus, Ohio

Regina, Sask., Can.
Rockford, Ill.
Salisbury, N. C.
Sioux Falls, S. D.
Springfield, Mo.

St. Louis, Mo.
Trenton, N. J.
Waynesboro, Pa.
Wichita, Kan.
Williamsport, Pa.

DISTRIBUTORS

Miller-Cahoon Co., Murray, Utah and Idaho Falls, Idaho
Thompson Machy. Co., New Orleans, La.

TRANSFER POINTS

Abilene, Texas Baltimore, Md. Jennings, La.

Emerson-Brantingham Implement Company
(Incorporated)
Good Farm Machinery Business Founded 1852
Rockford, Ill., U. S. A.



E-B (Geiser Works), Waynesboro, Pa.



No. 1. Geiser Sawmill with Engine Housed.

No. 2. Peerless Portable Engine and Geiser Saw Mill

No. 3. Geiser Saw Mill and Peerless Traction Engine.

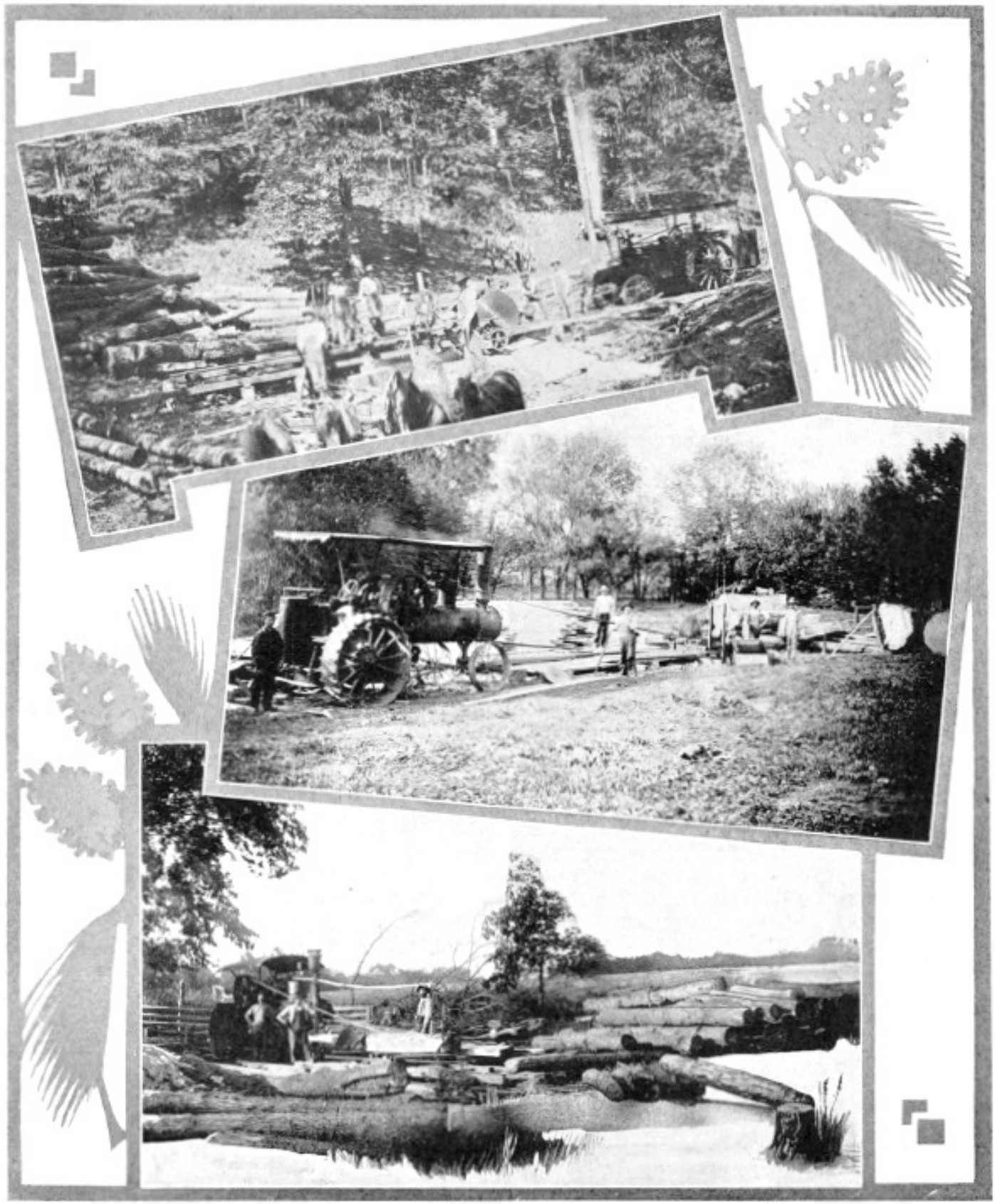

No. 1. Geiser Saw Mill and Peerless Traction Engine in the hills.
Geiser Saw Mills.

No. 2. Peerless Traction Engine and
Geiser Saw Mills.

No. 3. Peerless Traction Engine and Geiser Saw Mill ready for work.

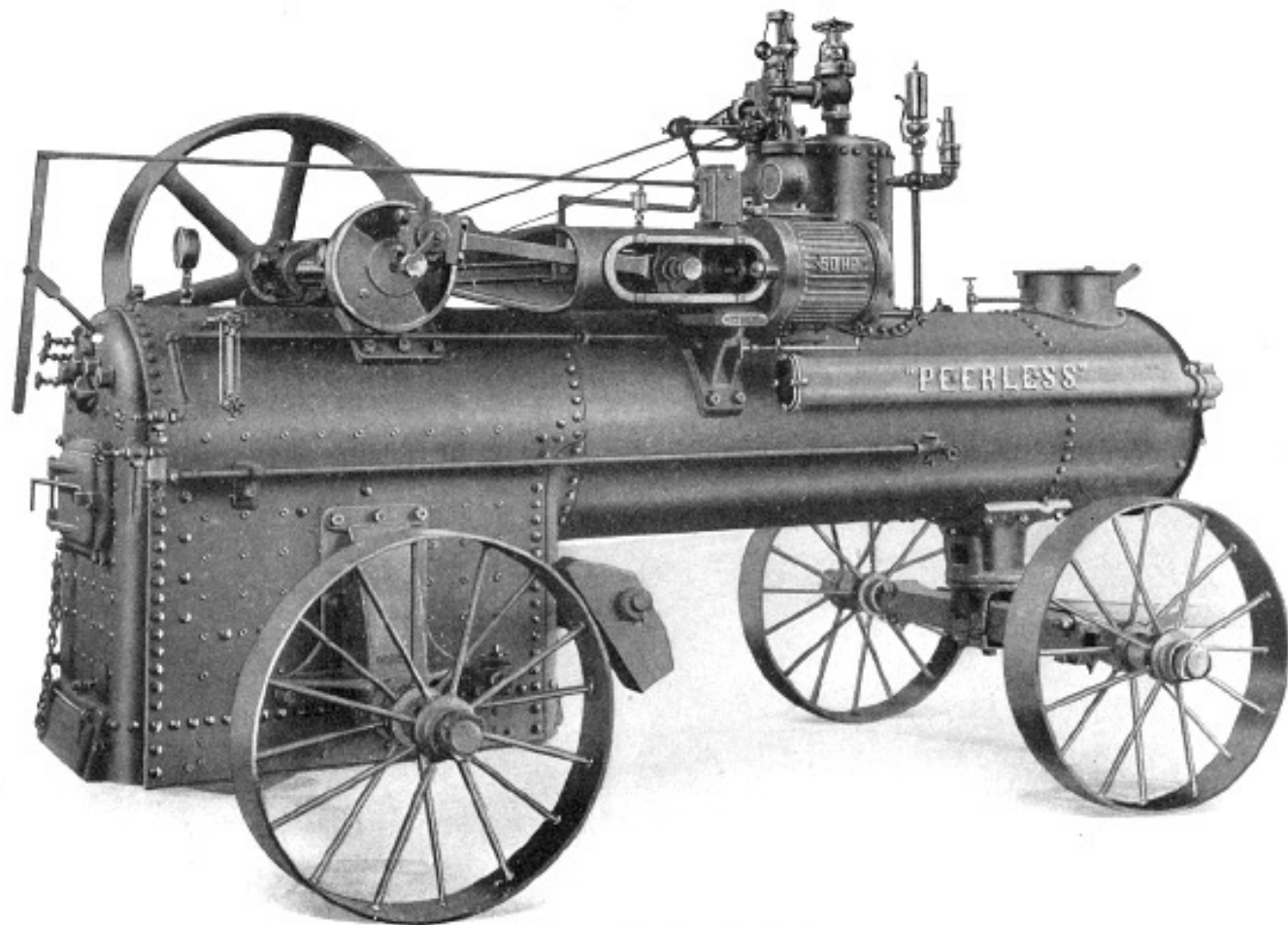

Peerless 50 H. P. Portable Engine

Peerless Portable Steam Engines

Peerless Portable Engines are built in 40, 50 and 60 H. P. All equipped with the new A. S. M. E. Code high pressure boiler and are the last word in boiler construction. Higher pressure boilers stand for safety, economy and power.

These engines are designed for general work of any kind where power is required, and are especially suited for the operation of our line of saw mills.

THE "PEERLESS" BOILER is of the most approved style and pattern of the A. S. M. E. high pressure boiler by which the greatest amount of water and steam space is secured within the specified limits. It is made of the **Best American Steel Boiler Plate** and is of such design and form as to give it uniform strength, and at the same time produce the best results with the greatest economy.

THE TUBES are of the best American lap-welded, fastened in the heads by an approved process of our own and so arranged and distributed as to give the best results from a given amount of heating surface, and at the same time allow the steam generated below to pass to the surface above with the least possible agitation of the water. This result, together with the steam space and ample water surface, allows the steam to separate from the water without priming or foaming when a sudden increase of steam is required.

THE FIRE BOX is surrounded by water on all sides except under the grates. We do not use the semi-circular water bottom, which prevents a perfect draft, catches the ashes, corrodes and rusts through in a few years and which, being below the fire and not acted upon by it, is a condensing instead of generating surface. The grates are placed a sufficient distance above the bottom of the water space to allow ample room for the deposit of any sediment, which can be easily removed through openings left at the corners for that purpose.

THE CYLINDER AND STEAM CHEST are combined in one casting, making only one joint on the steam chest. The cylinder is made with one end closed, except a small opening in the center, in which a brass stuffing box for the piston rod is inserted, and leaving only two steam joints in the cylinder and steam chest. The bolts which secure the cylinder head and steam chest cover are nearly all made with head and screw end for nut, and if broken, are easily replaced.

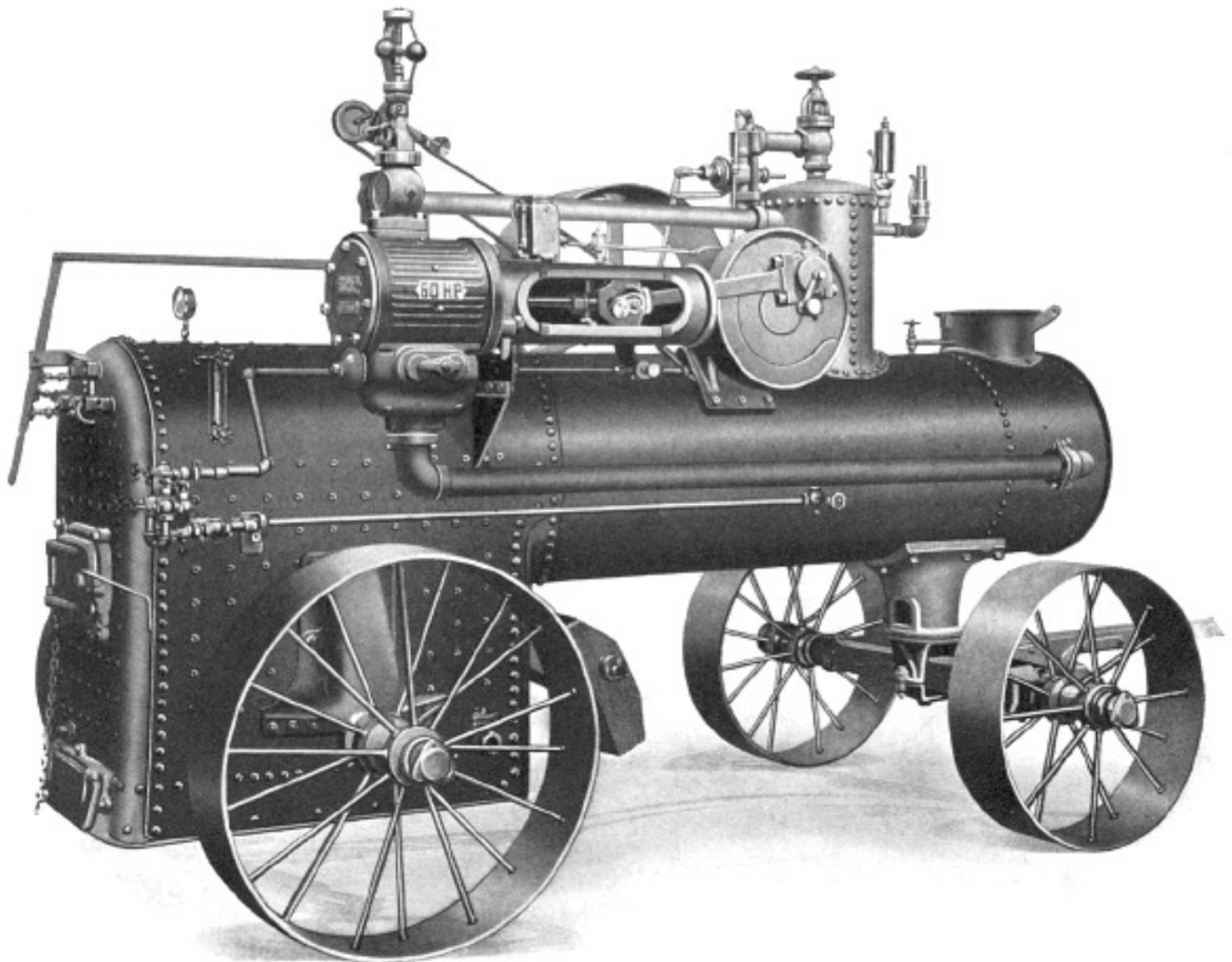

Peerless 60 H. P. Portable Engine

THE CYLINDER is bolted at one end to a flange cast on the end of the frame or bed-plate. By this arrangement the cylinder is free to expand, as it rests in a bracket fastened to the boiler, allowing this bracket to slide under the cylinder as the boiler expands or contracts, thereby relieving the engine and boiler from all strain whatever caused by expansion or contraction, and correcting a fault common to many portable engines.

THE BED PLATE is of the side-bed form, and is turned off at one end for the cylinder, and at the other for the saddle. These surfaces are bolted together, so that nothing can get out of line.

THE SADDLE OR BEARINGS for the crank shaft are the kind used in first-class stationary engines. Arrangements for adjusting are very simple. (See our special instruction book for full directions for running engine). The bearings are made very large, and will run a long time before any adjustment is necessary.

THE CRANK SHAFT AND PIN, also the cross-head pin, are large, made of steel, with surface hard and very close-grained, and ground true by special machinery. The crank shaft extends through the fly-wheel far enough to admit of an extra pulley being put on, if desired, which adds the only advantage of a center crank engine and avoids its disadvantages.

BALANCED PISTON VALVE. The Peerless is the only portable engine on the market equipped with a balanced piston valve in all sizes. This Balanced Piston Valve is used only in Peerless Traction Engines. Valve and its bushings are hard as glass, ground to a perfect fit. It is practically frictionless and with reasonable lubrication there is nothing to wear and the valve will perform its duty with greatest economy in fuel and water consumption. With it, operator can control engine by reverse lever when under full steam pressure. In case of necessity, replacement can be made at small cost.

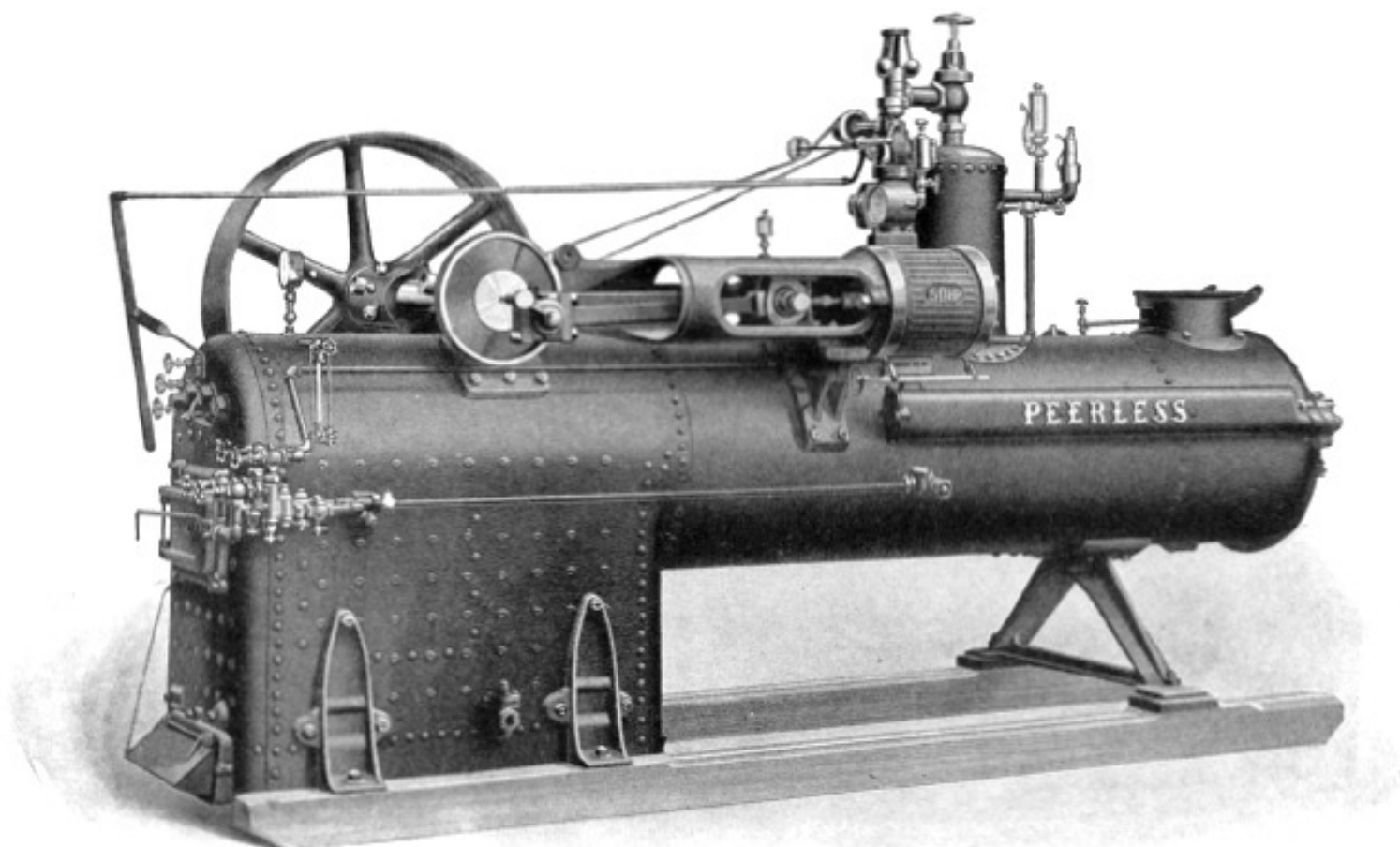

Peerless Portable Engine on Skids
Right Side View

THE ECCENTRIC for operating the slide-valve in the Portable Engine is placed back of the crank-wheel, and (by a device of our own) arranged so that by loosening a nut on the front of the crank-wheel, the eccentric can be reversed to produce the opposite motion in a very short time, and by an inexperienced person. With this arrangement the eccentric can never become displaced, as it will move only the proper amount to place the valve in correct position for either motion of the engine.

THE PISTON HEAD is made in two parts with metallic, self-adjusting rings, having no bolts, nuts or springs, and requiring no adjustment whatever. The rings readily adapt themselves to the surface of the cylinder, and will remain Steam-tight until actually worn out.

All parts of our engines are built to standard gauges, and with scrupulous regard to uniformity and accuracy in workmanship, thereby making all parts interchangeable, thus allowing any part, when broken, to be duplicated at very short notice, which is important to those using a portable or traction engine. All our engines and boilers are thoroughly tested before leaving the works. The engines are run until known to be in perfect running order.

ALL BOLTS ABOUT ENGINE are made with head and nut, and the whole machine can be taken apart with an ordinary wrench by the operator. **All parts being interchangeable**, they will, when replaced, always fit.

These engines are furnished regularly with U. S. Injector.

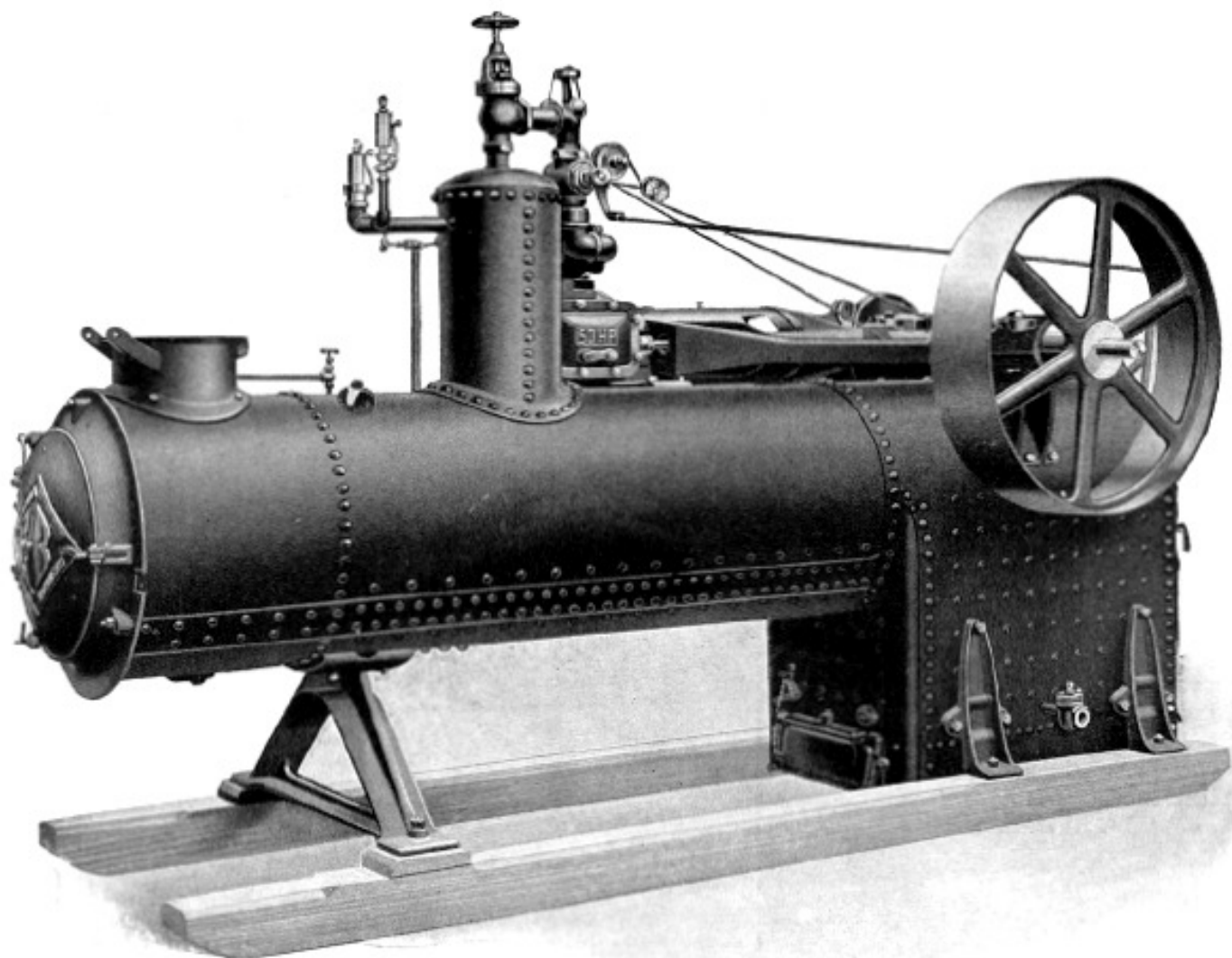

Peerless Portable Engine on Skids
Left Side View

DIMENSIONS OF PEERLESS PORTABLE ENGINES

Horse Power	Cylinder		BOILER						Fly Wheel			Stack			Approximate Weight on Wheels	Approximate Weight on Skids
	Bore	Stroke	Waist	Fire Box		Tubes			Diameter	Width	Revolutions	Diameter in Inches	Length Feet on Wheels	Length Feet on Skids		
				Length	Width	Number	Diameter	Length								
40	8	10	26	42	21	32	12	73	42	9	250	12 1/2	18 1/2	21	7,600	6,800
50	8 3/4	10	29	44	23	42	12	80	42	10	250	13 1/2	18 1/2	21	9,900	8,200
60	9 1/2	10	32	46	26	52	12	84	42	12	250	14 1/2	18 1/2	21	11,500	9,500

Description and Equipment of Geiser Saw Mills

Geiser saw mills are unequalled for steady work, accuracy and capacity. They are constructed in a superior manner, simple and complete in every part, and of ample strength for service any kind of logs or any class of lumber. They are backed by a Company with years of experience in building saw mills, and the big U-S organization with branches in all parts of the country, so that repairs can be readily obtained. The Geiser mill is made in four sizes, right hand type unless other size ordered. Nos. 1 and 2 made in single only; Nos. 3 and 4 in either single or double.

Equipment

The regular equipment includes either our Patent Variable Automatic Position Feed or Straight Line Belt Feed, Improved Hot Works, New Style Saw Guide, Patent Dogs, Two Steamboilers, Blotter Head Blocks, Internal Belt, Binding Pulley, one gear roller and wheels for Lumber Truck, Mangle, Wrench, Bolt Punch, Case Hooks, Oil Can and Blower.

The ways are regularly furnished on all mills without extra charge, and the track pins, in perfectly fitted up cases, making the entire track complete ready to set and go to working, not requiring, as in many mills, the expense and consequent loss of time incident to making these ways.

For a list of what is furnished with our mills regularly, and for cost of extra attachments, see machinery price list.

The Line

GEISER SAW MILLS

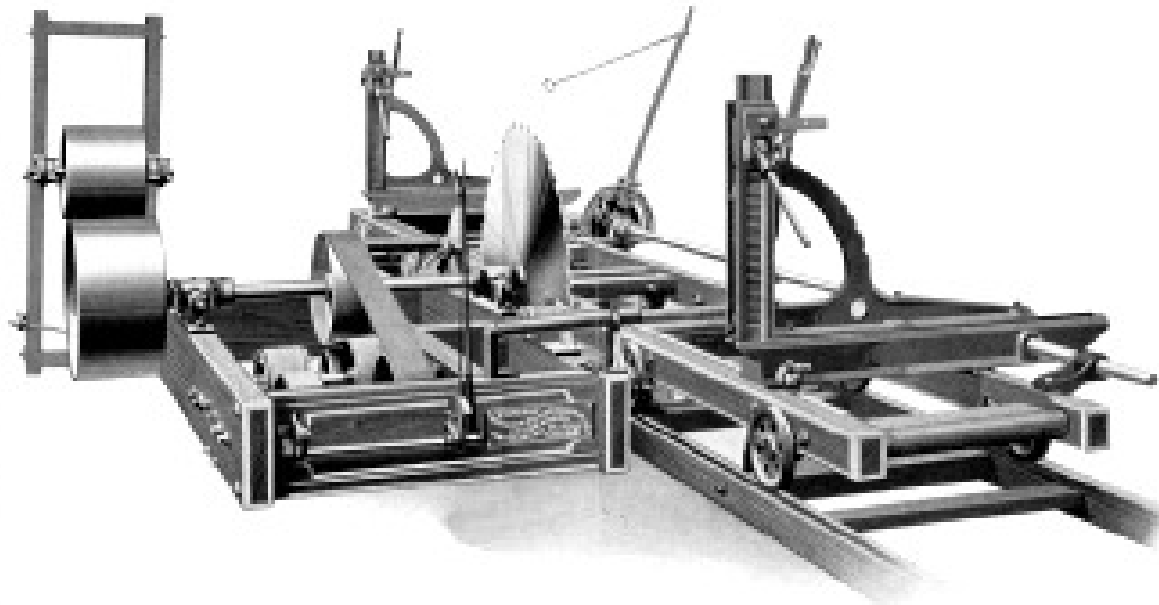

NINE REASONS Why a Geiser Saw Mill is the one you want

First—They are so simple and complete in their construction that they do not require a skilled mechanic to set them up.

Second—The feed is self-contained, is independent of, and does not interfere with the movement of the saw mounted on dogs, are appreciated by practical saw mill men.

Third—By the superior design and construction of our rounded boxes (see cut,) the rounded saw is adjusted with an accuracy not obtained in any other mill.

Fourth—The back and ways are so rigidly constructed by bolts and nuts that they cannot get out of line.

Fifth—The saw guide can be adjusted at any time, even while the saw is running.

Sixth—The roller runs in long, self-lubricating boxes. You can fill the oil cup and the mill does the rest.

Seventh—Our lever roller has no springs to get out of order. It will run the head blocks back 12 inches at one throw.

Eighth—The head block knees and rock are in separate sections; therefore, the breaking of a cog does not cause the replacing of a knee, which is a great saving. The rock and the pinion on our shaft are steel cut gears. This rock is secured to the knee or oil by accurately fitting machine bolts, so that with our steel cut gear and our set works there is absolutely no lost motion, and further is manufactured of uniform thickness.

Ninth—The set works are accurate, and will set to 1/32 of an inch.

Geiser Saw Mill Specifications

Mill Number	Head			Carriage Timbers Inches	Way Timbers Inches	Carriage Wheel Diameter Inches	Mandrel		Mandrel Pulley		Head Blocks Open from Knee to Run Inches	Knee High Dishes	Feed Pulley		Will Drive Saw	Length of Carriage Feet	Length of Ways Feet
	Inches Long	Inches Wide	Height Inches				Length Inches	Diameter Inches	Diameter Inches	Pitch Inches			Diameter Inches	Pitch Inches			
1	80	46	12 1/2 x 4	4 x 2 1/2	2 1/2 x 4 1/2	6	47 1/2	2 1/2	24	12	48	30	21	5	60	20, 25 or 30	45, 50 or 60
2	95	51	13 1/2 x 4	4 x 2 1/2	2 1/2 x 4 1/2	10	54 1/2	2 1/2	24	12	48	30	21	5	60	20, 25 or 30	45, 50 or 60
3	100	62 1/2	15 1/2 x 4	5 x 3	4 x 5 1/2	10	57	2 1/2	28	12	48	40	27	5 1/2	65	20, 25 or 30	45, 50 or 60
4	100	62 1/2	15 1/2 x 4	5 x 3	4 x 5 1/2	10	57	2 1/2	28	14	52	40	27	5 1/2	70	20, 25 or 30	45, 50 or 60



Detailed Description of Geiser Saw Mills

We call special attention to the fact that the carriage timbers are not cut out to admit the axle boxes, consequently they are much stronger than in other mills. The carriage sections are joined together by rods running through, with washers and nuts on the outside (see cut), making them as rigid as one continuous rail. The husk and ways are built in the same substantial way. Owing to this construction of the husk the saw is held in one position all the time.

THE CARRIAGE AXLES are of cold-rolled steel, turned true, having a V-shaped wheel keyed on one end and a flanged wheel on the other end. They run in long babbitted boxes on the under side of the carriage. (Note this feature). The weight of the carriage is on top of the box. This box has a slot for oil nearly the full length.

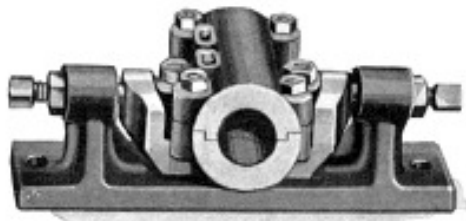

Mandrel and Axle Boxes

The oil cup is very large, running well up on the inside of the carriage (see cut), and will hold enough oil for several days. It cannot ooze out while the mill is standing. Now, as the oil is at all times lying on top of the axle, every revolution of the axle produces a perfect lubrication.

The mandrel runs in very long, self-adjusting pivoted boxes, lined with babbitt metal (see cut). The saddle is bolted on the husk solid. The box hangs on two "steady" pins with lock nut, and the box is held rigid by two bolts through the box and the box hanger. By means of these, the sawyer can swing his saw so as to lead in or out of the log without disturbing the main seat or saddle. This feature cannot be

found in any other make of mills. All millmen know how uncertain it is to slew the box when it is pivoted on the frame of the husk.

It is not necessary for us to refute the statement made by some builders of mills, that a light mandrel is as good as a heavy one. Lumbermen know that a shaft which is liable to spring cannot be relied upon for good work. It is only used in cheaply constructed mills. You won't find it in ours.

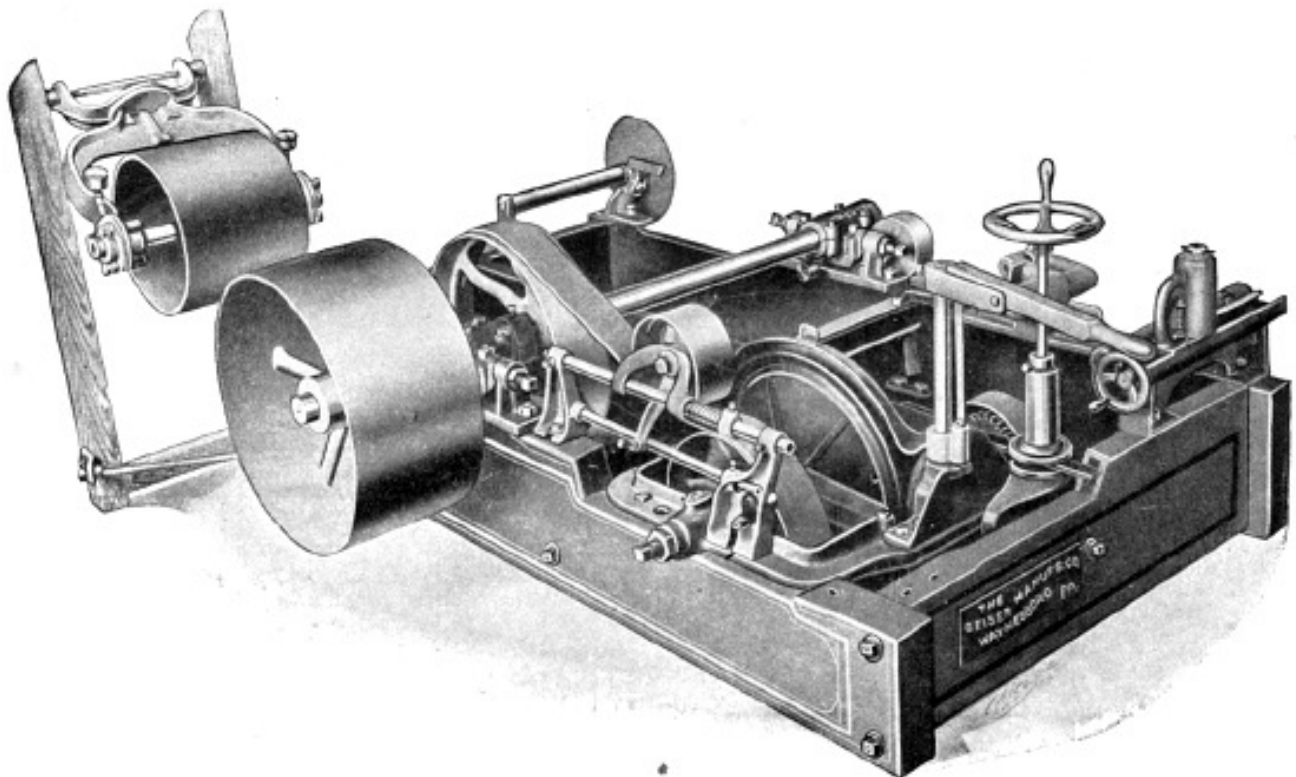

Geiser New Main Belt and Feed Belt Tighteners

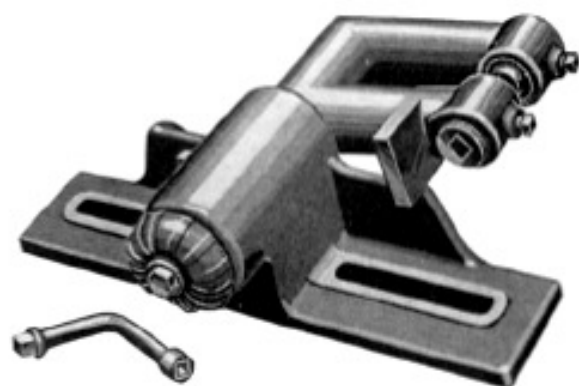

Our New Saw Guide

are extra heavy, planed true, provided with rack for dog, and open 40 inches for No. 1 Mill, 40 inches for the No. 2 Mill, 46 inches for the No. 3 Mill and 52 inches for the No. 4 Mill.

OUR PATENT DOG is simple, durable and sure. The jaw is of steel, securely held in place by a pin, and has a set of from one to six inches. It is raised and lowered by drawing the lever out, which allows the pinion to revolve; then when you let go of the lever a spring causes it to engage with the pinion and arrest the motion of the dog. It is then impossible for the dog to drop. If, after having dogged the log, you wish to lock the dog, raise

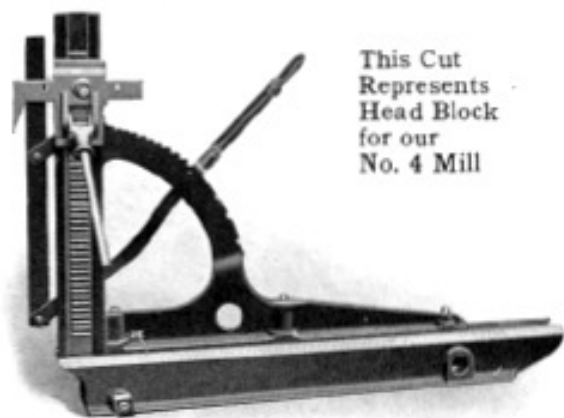

This Cut Represents Head Block for our No. 4 Mill

the lever and let it slide into top cog of pinion. Your dog is then locked perfectly.

adjustment in the spacing pawl, thirty-seconds of an inch can be obtained. The spacing pawl can be lifted to clear the top of the spacing block on the quadrant, thus allowing the operator to make a full throw of the set lever without disarranging the spacing block. The set or ratchet wheel has a four and one-fourth inch face and the teeth are machine cut thus insuring a round wheel with accurate spacing.

The pawls are neatly fitted to the teeth of the ratchet wheel, so as to take up practically all lost motion or back-lash. The set lever is provided with five pawls, carried on an eccentric sleeve, thus providing an easy means of adjustment if needed, and a single pawl for backing and reeving the knees, all within easy reach of the sawyer or block setter. This reeving pawl, however, is only for use where parties do not have either our lever or foot power receder, which are more desirable.

This set works will attach to mills of other make if size of such shaft is given in order.

OUR NEW SAW GUIDE

The guide pins are of hard wood inserted in threaded brass caps. To change the lead of the saw, a slight turn of the hand wheel in the direction required is all that is necessary.

The guide is reversible and can be used on right or left hand mills. It can be turned back to remove the saw without affecting the adjustment or displacing the guide.

OUR SPLITTER AND ROLLER is provided with stand and cap so constructed (see cut) that the splitter can be adjusted to or from the saw by simply loosening one nut. This feature is greatly appreciated by mill men.

GEISER HEAD BLOCKS are extra heavy, with long extensions, which support the knees when wide open. The knees

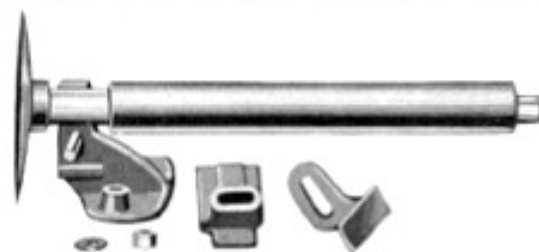

Splitter and Roller

OUR IMPROVED SET WORKS Furnished regularly on all our Mills.

Will set accurately from one-half inch to two and three-quarter inches by sixteenths, and by means of the eccentric



Our Improved Set Works

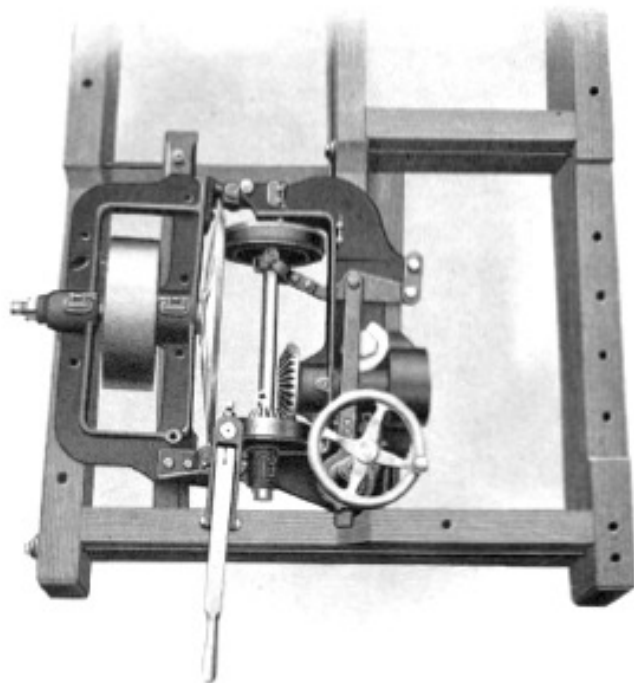

Variable Automatic Disc Friction Feed

OUR VARIABLE AUTOMATIC DISC FRICTION FEED is simple, efficient and durable. Its construction differs from other variable feeds, in that there is no disc on the mandrel (thus avoiding the thrusts on the saw, common to other disc feeds), the disc being on a shaft which is driven from a pulley on the mandrel.

There are two friction wheels as shown in cut—one for the forward motion, the other for the gig-back. These friction wheels are brought in contact with the disc by a slight movement of the lever, and are held there by the contact of the pinions (see cut) when exerting the power necessary to drive the carriage, hence the greater the load on the carriage the greater the pressure of friction wheels against the disc, thus making it practically an automatic feed and relieving the sawyer of the necessity of holding the lever constantly—an important point, and one not attained in the variable friction feeds made by others. The variation is from one-quarter to five inches to each revolution of the saw, and is produced by turning a hand-wheel (which will remain in adjustment for any rate of feed without holding and can be turned with ease while the saw is in the log) with a degree of accuracy not attained in any other friction feed; thus, the sawyer has perfect control over the feed under all circumstances.

The whole feed mechanism is self-contained. It is enclosed, preventing saw dust from accumulating therein, thus reducing the liability to wear. The gig-back movement is quick and positive and can be varied.

OUR STRAIGHT LINE BELT FEED. This feed, though similar in outline to others, is superior in details of construction, eliminating their weak points.

Saw mill operators familiar with Straight Line Feeds are aware that the varying of the feed of the log into the saw and the reverse is accomplished by slippage between the feed shaft friction wheel and the paper drivers. The contact between these two wheels is usually controlled by a solid eccentric box, every movement of which springs the feed shaft out of alignment, thus causing the box to become loose and requiring almost the constant grip of the operator upon the feed lever to control the feed. With our specially designed eccentric with universal box combined, we have practically eliminated this and place it within the power of the operator to control his feed to a nicety without being compelled to retain a constant grip on the feed lever, thus very nearly approaching the positive variable or changeable feed.

The tightening pulley being within easy reach, enables the operator to run with either a tight or loose belt, a little slippage of which in some cases is very desirable.

All bearings are universal and are provided with easy means for adjusting the friction.

This feed is very desirable for Portable Mills, as no pulleys project below the husk timbers, and by removing eight nuts with a common wrench, all pulleys, shafting and paper frictions can be removed from the husk in a few minutes and can be replaced without disarranging the adjustments in the least.

We furnish 5-inch feed belt, 5 $\frac{3}{4}$ -inch paper frictions for Nos. 1 and 2 Mills, and 6-inch feed belt, 6 $\frac{3}{4}$ -inch paper frictions for Nos. 3 and 4 Mills.

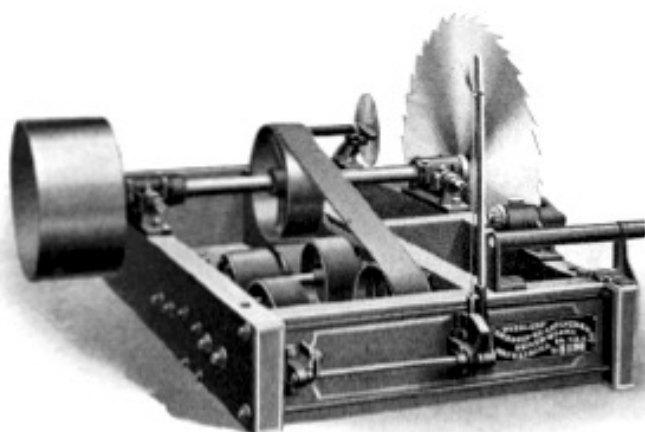

Straight Line Belt Feed



Special Equipment and Extras



Top Saw Rigging

GEISER TOP SAW RIGGING

This attachment is made of iron, adjustable, and built substantial and true. The mandrel is carried in long, self-oiling bearings. It can be put on our No. 3 or 4 Mill, but not on No. 1 and No. 2, except by using a heavy husk.

PATENT KNEE

For Nos. 1, 2 and 3 Mills. An indispensable attachment to a "Simultaneous" Mill.



Patent Knee

THE NEW AUTOMATIC SET WORKS

This set works will attach to any of our mills; also mills of other make, if size of set shaft is given in order.

The lever carries two pawls, one for forward and one for backward motion. The ratchet wheel is held in a fixed position by a friction roller which is in contact with the inner face of the ratchet wheel. The special pawl adjusts itself to the teeth of the ratchet wheel at every back or return motion of the lever, bringing the toothed segment upon which the coil spring is mounted in contact with the pawl secured to the quadrant. This reverses the eccentric

the full throw, and at the same time winds up a spring, which, when tripped off by the rear pawl, again reverse the eccentric, forcing the pawl carried by the eccentric forward against the nearest tooth. **This eliminates all Lost Motions** caused by the wear of journals and parts. The wheel is 2-inch face and **Machine Cut**, with pawl the full width. The quadrant is drilled to represent 1-16, and is accurately indexed by special machinery. The serrated block, bolted on the side of the lever when moved in either direction, represents 1-32 of an inch more or less in space. By throwing the tripping pawl on quadrant back, the automatic device can be left out of use when sawing irregular thicknesses of lumber or when using graduations on the head blocks. One quarter turn of the hand lever raises and lowers the pawls for back or forward motions, and a push rod extending across the carriage to within easy reach of the operator, which can be used if desired, is also furnished.

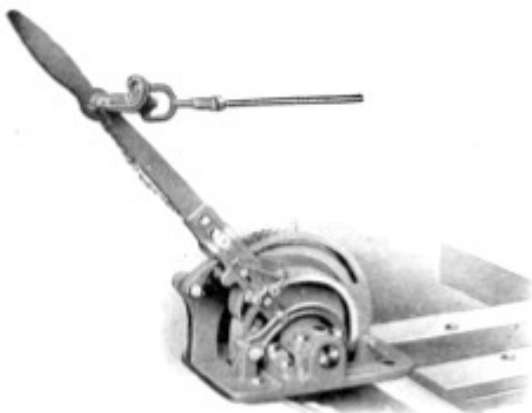

Automatic Set Works

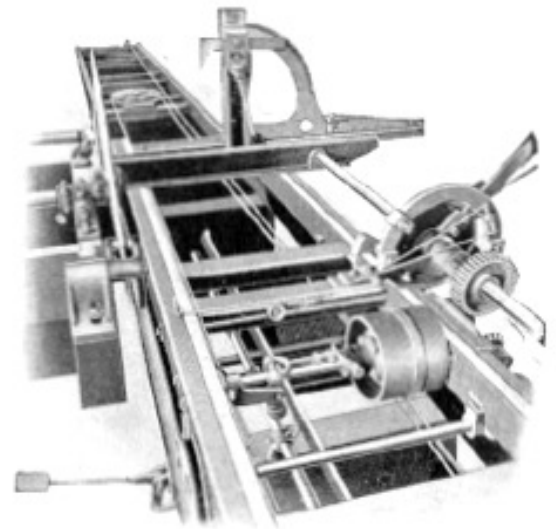
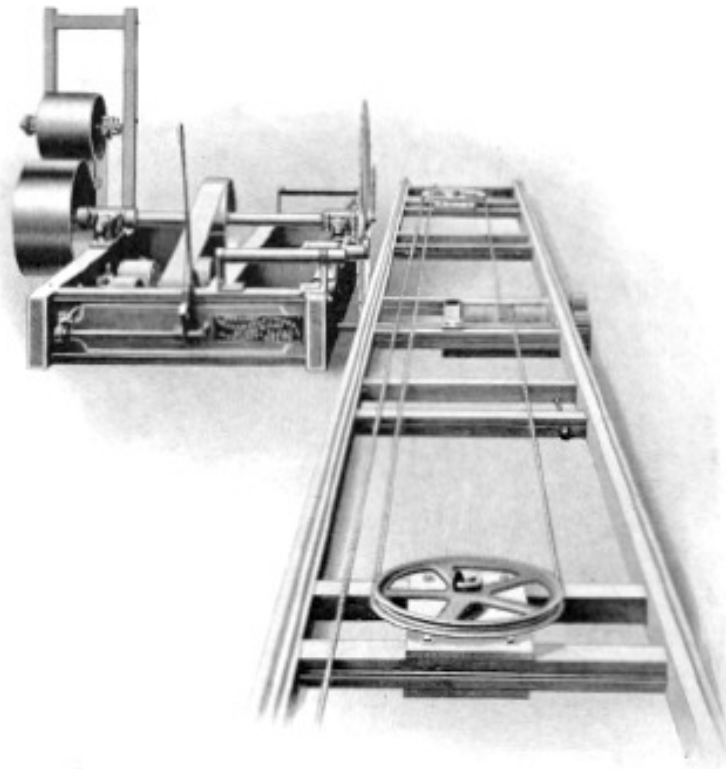

OUR FOOT LEVER POWER RECEDER is a positive cable-driven attachment for quickly removing the ells backward and forward while carriage is moving. Makes quick work possible and soon pays for itself.

This Cut is Designed to Show How the Cable is Attached to Our Mills, Location of Sheaves, Pulleys, etc.

OUR CABLE DRIVE MILLS are the popular mill. They are quick and positive in their action and increase the capacity of a mill because additional Ways can be used and a longer log can be sawed; further, the carriage can be run in either direction beyond the limits of a rack bar, thus facilitating the putting on of logs or taking off lumber clear of the husk. The cable is 7-16 inch steel and with ordinary care will last for years.

Note—Sheave pulleys are so placed that they do not project below bottom of Ways, therefore do not interfere with setting of mill level and solid.

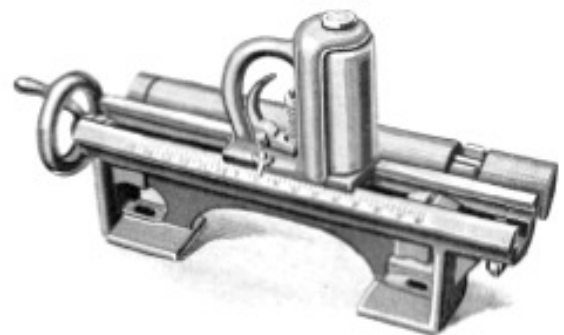

Combined Gauge and Lumber Roller

GAUGE ROLLER

The vertical roller can be moved to or from the saw by means of a screw operated by the hand wheel. It is a plainly graduated scale, is adjustable to 15 inches, and when not in use can be quickly moved back out of the way by hand, which is a great convenience. It has cast lugs to receive our standard lumber roller.

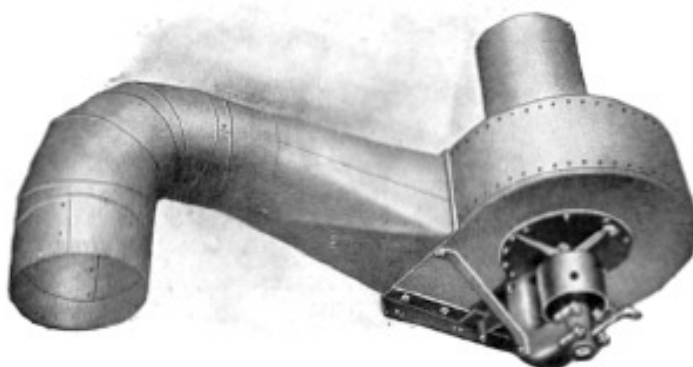

Saw Dust Blower

Furnished regularly with 16 feet Pipe from Elbow.

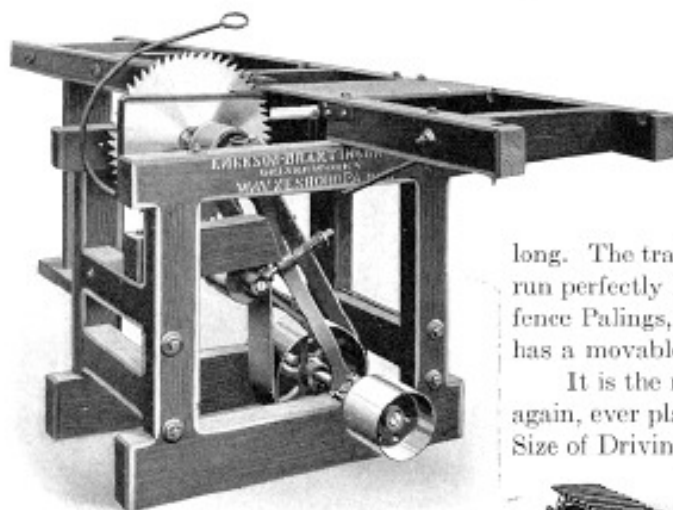

SWINGING CROSS-CUT SAW

One of the most complete on the market; has a 12-foot table and steel roller. The slab or board to be cut is readily moved and the saw is easily drawn through the board. Furnished with 20 to 30-inch Saw.

DUPLEX LOG TURNER

While many log turners are used by up-to-date lumbermen with advantage and profit, we believe this time and labor saving attachment is not sufficiently known to the trade and it would be used by more mill men as a part of their equipment. For portable mills it is superior to any other turner on the market and more nearly

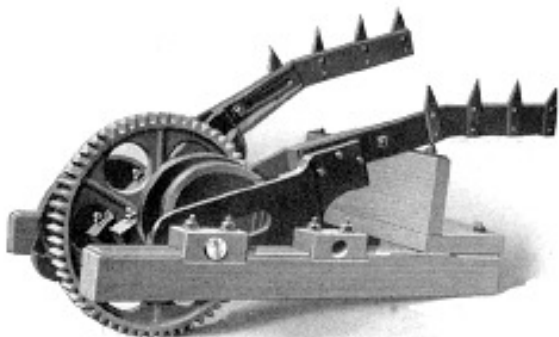

Duplex Log Turner

approaches the steam turner than any other. It can be furnished on mills of Geiser or other make. It is a log loader, in assisting the loading of logs on the carriage, a hand spiker, a straightener of timber and increases output of mill. It is simple, strong and effective, easily operated and controlled by means of a lever within convenient reach, placing log in any desirable position. To make it more serviceable on Geiser mills, we have arranged all head blocks so

they can be secured by a holding hook to prevent tilting when log is forced against the ells by the lifting force of the turner, and with our steel racks on the ells, there is no danger of breaking gears by use of this turner.

SAWDUST ELEVATORS. The cut shows the general design of one sawdust elevator. The belting or carrier is made of 1 1/4-inch x 3-16-inch steel, exact pitch. Sprockets are especially designed for this carrier 14 inches diameter, 4 inch face, shafts of which run in carefully babbitted boxes. They are driven by worm gears which run in oil in a practically dust-proof case of cast iron. This elevator is a convenient attachment for Portable Mills, and only requires a pit 24 inches wide. We can furnish the Elevator with No. 55 Standard Chain and hard-wood blocks, if a lighter machine is wanted, or sawdust blower shown on page 14.

GEISER HAND EDGER

The legs are made of cast iron, and the two that support the saw table are extended to support the track rail, thus giving great solidity and strength where the power is applied and the edging done. The Track, which is regular 12-pound steel rail, is planed and fits in castings bolted to top of legs. The carriage is 16 feet long. The track being planed and the rollers turned, makes the carriage run perfectly level and smooth. This edger can be utilized for cutting fence Palings, Furring Strips, etc., out of rejected lumber, as the table has a movable gauge to make any width desired.

It is the most convenient machine to take down, move and set up again, ever placed on the market.

Size of Driving Pulley, 6 in. in diameter, 8 in. face. Size of Saw, 20 in. in diameter. Revolutions required of Saw Mandrel, 1,800 per minute.

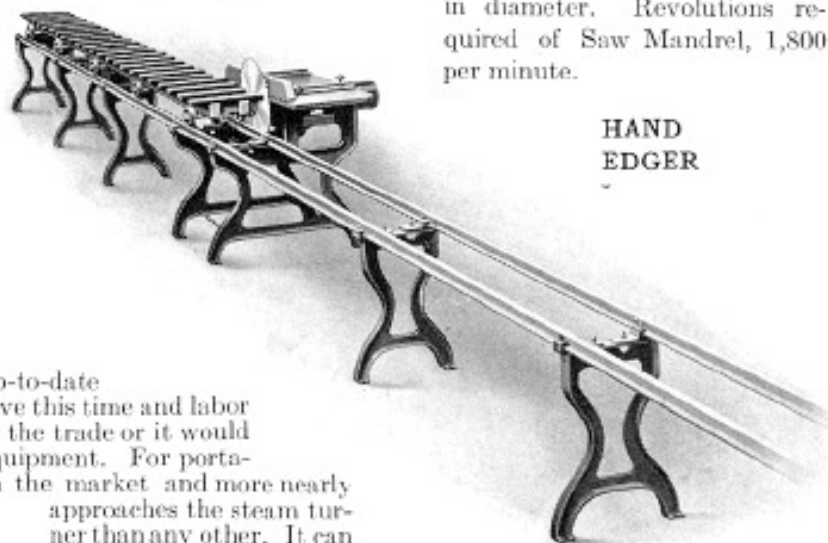

HAND EDGER



SAW DUST ELEVATOR
Standard Lengths 20 feet—Additional Lengths Extra.

The



Line

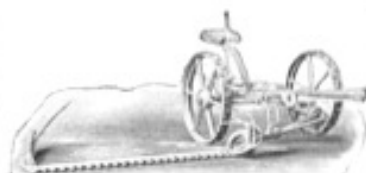

E-B STANDARD MOWER

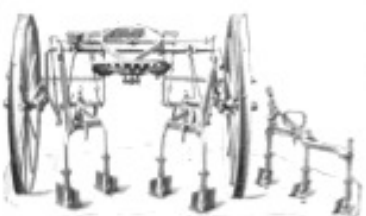

E-B LEVERLESS CULTIVATOR



E-B A-1 GRAIN DRILL



E-B NO. 1 MANURE SPREADER



E-B VEHICLES



E-B NEWTON WAGONS

The "E-B" Line of Farm Machinery has been successfully used by generations of American Farmers. The best of materials and workmanship, prove their value in "E-B" machines.

Our Complete Line

- | | |
|---------------|--------------|
| Plows | Manure |
| Harrows | Spreaders |
| Cultivators | Kerosene |
| Pulverizers | Tractors |
| Listers | Engines |
| Planters | Plows |
| Stalk | Threshers |
| Cutters | Road Rollers |
| Mowers | Stationary |
| Rakes | Engines |
| Tedders | Binder |
| Hay Loaders | Engines |
| Stackers | Portable |
| Vehicles | Engines |
| Auto Trailers | Pump Jacks |
| Wagons | Corn |
| Grain Drills | Shellers |
| Saw Mills | Hay Presses |



E-B FOOT-LIFT PLOW



E-B TYPE U GAS ENGINE



E-B 12-20 KEROSENE TRACTOR

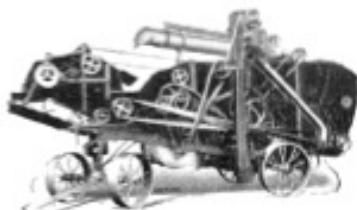

E-B PEERLESS SEPARATOR

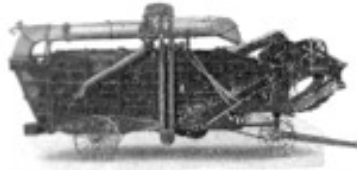

E-B REEVES 15-BAR SEPARATOR



E-B REEVES STEAM ENGINE

EMERSON-BRANTINGHAM FARM MACHINERY

