

CAREFULLY READ THE INSTRUCTIONS PROVIDED, OBSERVE THE SIMPLE SAFETY PRECAUTIONS, AND YOU WILL HAVE MANY HOURS OF SATISFACTORY USE FROM YOUR NEW CRAFTSMAN TOOL.

**ASSEMBLY, OPERATING INSTRUCTIONS
AND PARTS LIST FOR**

**CRAFTSMAN
COMMERCIAL**

HEAVY DUTY ROUTER

MODEL NUMBER 315.25070

The Model Number will be found on a name plate located on the Housing Cover. Always mention the Model Number in all correspondence regarding the CRAFTSMAN ROUTER or when ordering repair parts.

HOW TO ORDER REPAIR PARTS

All parts listed herein may be ordered through SEARS, ROEBUCK AND CO. or SIMPSONS-SEARS LIMITED. When ordering parts by mail from the catalog order house which serves the territory in which you live, ~~selling prices will be furnished on request or parts will be shipped at prevailing prices and you will be billed accordingly.~~

WHEN ORDERING REPAIR PARTS, ALWAYS GIVE THE FOLLOWING INFORMATION AS SHOWN IN THIS LIST:

1. The PART NUMBER
2. The PART NAME
3. The MODEL NUMBER—315.25070
4. The NAME of item—Heavy Duty Router

COAST TO COAST NATION-WIDE

SERVICE FROM SEARS

FOR YOUR CRAFTSMAN HEAVY DUTY ROUTER



SEARS, ROEBUCK AND CO. and SIMPSONS-SEARS LIMITED in Canada back up your investment with quick, expert mechanical service and genuine CRAFTSMAN replacement parts.

If and when you need repairs or service, call on us to protect your investment in this fine piece of equipment.

Designed exclusively for and sold only by
SEARS, ROEBUCK AND CO.—U.S.A.
IN CANADA, SIMPSONS-SEARS LIMITED

CRAFTSMAN HEAVY DUTY ROUTER—MODEL NUMBER 315.25070

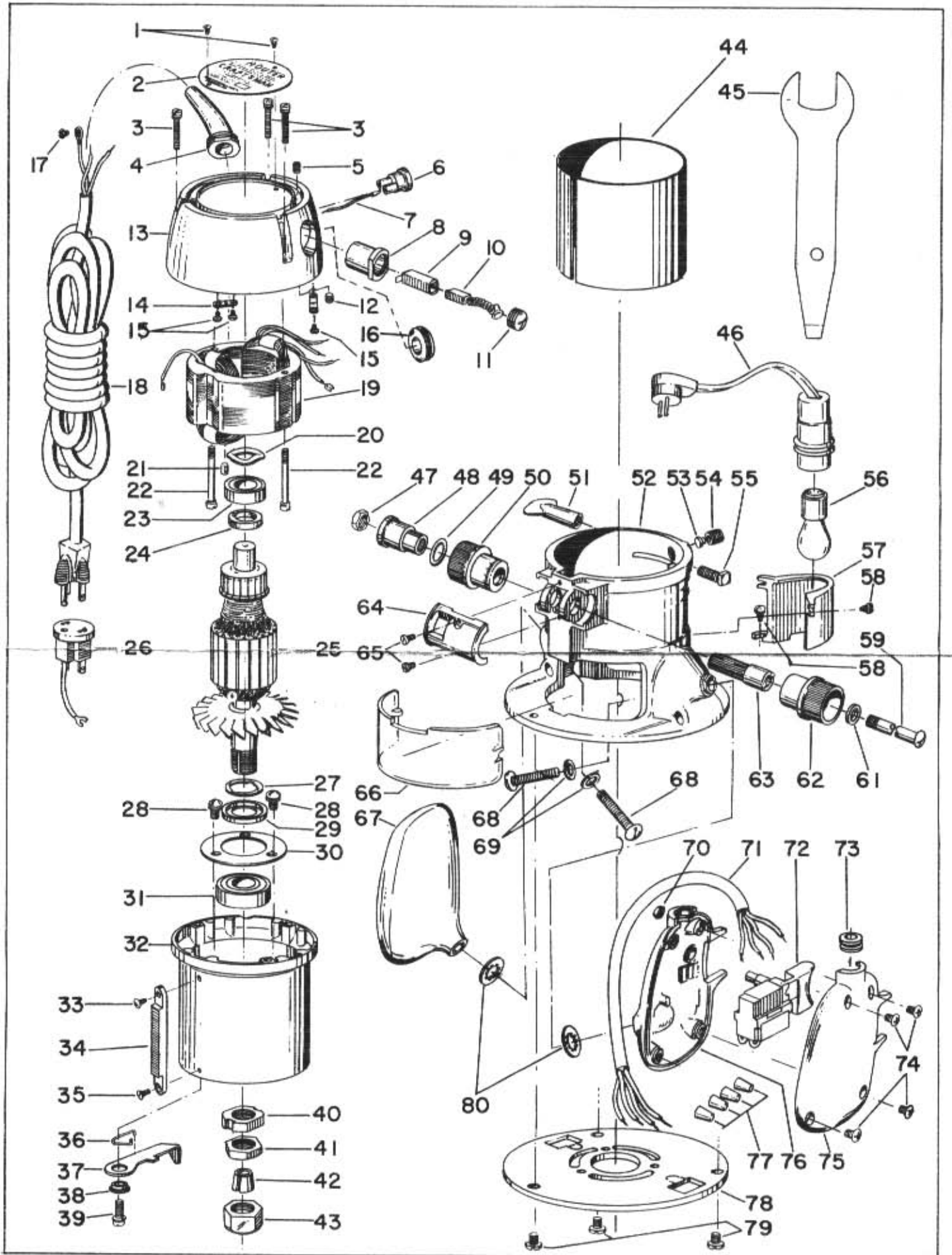

CRAFTSMAN HEAVY DUTY ROUTER—MODEL NUMBER 315.25070

WHEN ORDERING REPAIR PARTS, ALWAYS GIVE THE FOLLOWING INFORMATION

1. THE PART NUMBER
2. THE PART NAME

3. THE MODEL NUMBER—315.25070

4. THE NAME OF ITEM—HEAVY DUTY ROUTER

DO NOT USE KEY NOS. WHEN ORDERING REPAIR PARTS. ALWAYS USE PART NUMBERS.

PARTS LIST

Key No.	Part No.	Description	Quan.	Key No.	Part No.	Description	Quan.
1	1-795247-06	Drive Screw	2	39	1-940038-804	Screw (#8-32x5/8 Fil. Hd.)	1
2	2-623805-01	Nameplate	1	40	1-623793-01	Lock Nut	1
3	1-940038-805	Screw (#8-32x7/8 Fil. Hd.)	3	41	1-623794-02	Jam Nut	1
4	2-613651-01	Bend Relief	1	42	1-623791-01	Collet	1
5	1-930687-06	*Set Screw (#8-32x1/4 Hex Socket Headless)	2	43	1-623792-03	Collet Nut	1
6	2-623819-01	Socket Housing	1	44	2-623804-01	Housing Skirt	1
7	1-623858-01	Lead with Terminal	1	45	1-623813-03	Wrench	1
8	2-623436-01	Brush Holder	2	46	2-623809-01	Light Cord Complete	1
9	2-730373-00	Brush Tube	2	47	1-623281-02	Nut (#6-32)	1
10	2-730352-01	Brush Assembly	2	48	2-623789-01	Indicator Sleeve	1
11	1-614008-01	Brush Cap	2	49	1-623808-01	"O" Ring	1
12	1-930687-05	*Set Screw (#8-32x1/8 Hex Socket Headless)	1	50	2-623788-01	Indicator Knob	1
13	4-623775-03	Housing Cover	1	51	2-623815-02	Wing Nut — Special	1
14	1-623786-01	Cord Clamping Plate	2	52	4-623777-03	Base	1
15	1-930150-09	Screw (#6-20x3/8 Fil Hd. T.F.)	4	53	1-885868-01	Thrust Button	1
16	1-620351-00	Grommet	1	54	1-623817-02	Set Screw — Special	1
17	1-930993-01	Screw (#6-32x5/16 Pan Hd. T.C.)	1	55	1-623166-02	Square Head Bolt (1/4-20x3/4)	1
18	2-622662-02	Cord	1	56	1-623810-01	Light Bulb (Standard Automotive Bulb #94)	1
19	3-623785-01	Field Assembly	1	57	3-623811-02	Light Shroud	1
20	1-620789-06	Loading Spring	1	58	1-620725-04	Screw (#8-32x5/16 Rd. Hd.)	3
21	1-623019-02	Bearing Plug	1	59	1-703768-802	Screw (#6-32x2 Rd. Hd.)	1
22	1-940038-15	Screw (#8-32x1 3/4 Fil. Hd.)	2	61	1-621721-03	Washer	1
23	2-620332-01	Ball Bearing—SKF6001	1	62	2-624147-01	Height Adjusting Knob	1
24	1-703429-801	Washer	1	63	2-623790-01	Height Adjusting Pinion	1
25	2-623784-01	Armature Complete	1	64	3-623806-01	Height Indicator Cover	1
26	1-706875-00	Ground Adapter (Not Supplied with Canadian Tools)	1	65	1-622931-02	Screw (#6-32x1/4 Fil. Hd.)	2
27	1-623880-01	Retaining Ring	1	66	2-623812-01	Eye Shield	1
28	1-930678-802	*Screw (#8-32x1/2 Rd. Hd.)	3	67	2-623779-01	Handle Assembly	1
29	1-623881-01	Cupped Washer	1	68	1-930517-16	Screw (1/4-20x1 1/2 Rd. Hd.)	2
30	2-623787-01	Bearing Retainer Plate	1	69	1-703473-032	Lock Washer	2
31	1-622523-01	Ball Bearing—ND Z973L03	1	70	1-623281-01	Nut (#8-32)	4
32	4-623776-02	Housing	1	71	2-623783-01	Power Handle Cord	1
33	1-737983-03	*Screw (#8-32x3/8 Pan Hd.)	1	72	2-623814-01	Switch	1
34	2-623807-01	Gear Rack	1	73	1-623782-01	Grommet	1
35	1-703428-14	Screw (#8-32x7/16 Flat Hd.)	1	74	1-726693-01	Screw (#8-32x5/8 Fil. Hd.)	4
36	1-623797-01	Spring	1	75	4-623781-01	Power Handle Cover	1
37	1-623796-02	Locking Lever	1	76	4-623780-01	Power Handle	1
38	1-623795-02	Spacer	1	77	1-623173-01	Wire Connector	4
				78	3-623778-02	Sub Base	1
				79	1-623863-01	Screw (#10-32x1/4 Pan Hd.)	3
				80	1-931555-22	Washer	2
					EN 402	Instruction Sheet	

*Standard Hardware Item—May Be Purchased Locally

For Illustration — See Page 2

OPERATING INSTRUCTIONS

CRAFTSMAN HEAVY DUTY ROUTER—MODEL NUMBER 315.25070

CUSTOMER DO'S AND DON'TS

1. **DO** be sure that the voltage of the power supply agrees with the name plate marking on the router.
2. **DO** be sure tool is properly grounded especially if you are on a damp floor or ground. (See Grounding). If it is necessary to work in a wet or damp location, protect yourself further against possible shock by wearing rubber gloves and rubber footwear.
3. **DO** blow out air passages occasionally to keep unit clean to insure a cool running unit.
4. **DO** check bits and cutters periodically for tightness.
5. **DO** keep collet clean.
6. **DO** replace both brushes when either is worn to about $\frac{1}{4}$ " in length.
1. **DON'T** leave the power cord connected to the power supply when installing or changing cutters.
2. **DON'T** overload router to the point where speed is drastically reduced. Overloading causes overheating and possible burnouts.
3. **DON'T** use dull knives or cutters since they will not produce good work and will cause overloading.
4. **DON'T** use two wire extension cord.
5. **DON'T** pick the tool up by the power cord.
6. **DON'T** jerk the power cord to remove the plug from the socket.

CAUTION

GROUNDING—This tool is equipped with an Underwriters' Laboratories approved 3 prong plug for your safety. If your outlet is a grounded 3-cavity type, your tool will be grounded automatically.

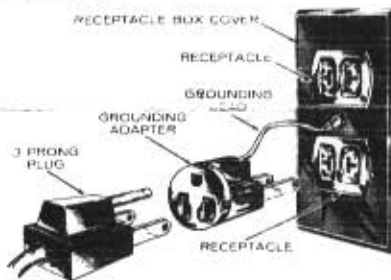

MAKE SURE BOX IS GROUNDED

Since many receptacle boxes in present construction will not have 3-cavity receptacles, an *adapter is packed with this tool. Make sure grounding lead is firmly

attached to a grounded receptacle box as shown above, before attempting to operate tool.

Extension cords should also be 3-wire.

*(Not used in Canada)

CAUTION: When electric tools are used on fiberglass boats, sports cars, etc., it has been found that they are subject to accelerated wear and possible premature failure, as the fiberglass chips and grindings are highly abrasive to bearings, brushes, commutator, etc. Consequently it is not recommended that this tool be used for continuous production work on any fiberglass material. During any use on fiberglass it is extremely important that the tool is cleaned frequently by blowing with an air jet.

REPAIR SERVICE AND PARTS—All fine tools, on occasion, may require service or the replacement of parts due to wear from normal use. To prolong the life of your tool when repairs are needed, call on your nearest Sears Catalog Order or Retail Store. Please don't risk possible additional cost or damage to the tool through inexperienced repairs. Sears Servicemen are factory trained.

EXTENSION CORDS—The use of any Extension Cord will cause some loss of power. To keep this to a minimum and to prevent overheating and motor burn-out, use the table below to determine the MINIMUM wire size. (A.W.G.) Extension Cord. Cords should be 3-wire grounded.

Extension Cord Length	Wire Size A.W.G.
25- 50 Feet	16
50- 75 Feet	14
75-100 Feet	12
100-200 Feet	10

WARNING: Disassembly of this tool can result in dangerous electrical hazard if any leads (wires) are pinched against metal surfaces or if grounding connection is not secure when tool is reassembled.

GUARANTEE: We guarantee all Craftsman portable electric tools to be free from defects in material and workmanship. When properly used, cared for, and maintained, we will replace or repair at our option, and install without cost to you, for a period of one (1) year from date of sale, any part which proves, upon our examination, to be defective under normal use.

The guarantee does not cover: burnouts due to low or improper voltage or from the tool being forced or otherwise improperly used; blades, cords or any other parts subjected to abuse; or tools used in rental service.

INSTRUCTIONS FOR OPERATING (continued)

CRAFTSMAN HEAVY DUTY ROUTER—MODEL NUMBER 315.25070

LUBRICATION—The ball bearings in this unit are packed with a sufficient amount of grease for the life of the unit when used in normal service.

BRUSHES—To replace carbon brushes (Key #10) Fig. 1, unscrew brush cap (Key #11) and remove old brush. Replace both brushes making sure when inserting that curvature of brush will match curvature of the surface of the armature to which it is mated. Make sure that the brushes move freely in the holder. Replacement of these relatively inexpensive parts, when necessary, will aid in getting full power from the unit and will prolong the life of the motor.



TO ASSEMBLE LIGHT ATTACHMENT TO ROUTER: Insert light bulb (key #56) into light socket end of light cord (key #46) with a gentle press and twist motion. The bulb required for this router is a standard 12-volt automotive bayonet base number 94 bulb, available at most auto supply stores and service stations. Insert the light socket into the light shroud (key #57) so that the upper edge of the shroud fits securely between the two rings on light socket. Attach assembly to back of router base (key #52) just below the wing nut, with three screws (key #58). Plug light cord into socket (key #6). The light will remain 'on' while the router is running.

TO ASSEMBLE EYESHIELD TO ROUTER: The eyeshield (key #66) attaches to the front of the router, covering the opening below the micrometer adjustment knobs. Gently squeeze the shield at each end so that the two tabs fit into the router base opening. Releasing the shield will cause it to securely grasp the edge of the base "window."

CHUCK—The chuck is a precision collet type. Do not tighten the collet unless a full size $\frac{1}{4}$ -inch shank bit is in the collet. Clean collet, collet nut and motor shaft taper frequently to maintain accuracy.

TO INSTALL CUTTERS—Insert shank of cutter all the way into collet. Hold lock nut (Key #40) with locking lever (Key #37) and tighten collet nut (Key #43) securely with wrench provided.

When removing the cutter, sometimes it may have a tendency to bind or stick in the collet. If this occurs, first be sure the collet nut is loose, then tap the body of the cutter lightly with a block of wood or mallet to release the cutter shank from the collet. Be careful not to damage the cutting edges of the cutter.

DEPTH OF CUT—The average cut should not exceed $\frac{1}{4}$ " depth per pass when using larger cutters. In hardwoods, two or three passes should be made when using the largest cutters available. Two or three passes in hardwood are more practical than risking possible damage to the motor unit or cutter breakage through overloading.

TO ADJUST FOR DEPTH OF CUT—See figure 2. Be sure switch is in "off" position. Place the router on a flat surface and loosen wing nut (key #51). The wing nut should be finger tight when making height adjustments to insure that the motor unit operates more freely in the base. Turn height adjusting knob (key #62) until tip of router bit just touches the surface. Turn indicator knob (key #50) to "0". Position router so that the bit can be projected below the base for desired setting. Now adjust to desired depth of cut by turning height adjusting knob slightly past the desired setting, then returning to the desired setting. This will insure a more accurate depth-of-cut adjustment. Tighten wing nut.

On successive cuts, always set indicator to "0" before loosening wing nut. The amount of cutter movement can then be read directly on the scale. Note that each graduation of the scale indicates $\frac{1}{64}$ inch change in setting.

An adjusting screw (key #54) has been provided to assure smooth elevation of the motor. With the motor unit unclamped in base, the screw is adjusted until light pressure is applied to side of motor housing. This pressure must be sufficient to hold the motor unit in an elevated position unclamped, yet permit the motor to be elevated by the right hand elevation knob without undue force. The adjusting screw (key #54) is set at the factory and should not have to be changed under normal use conditions.

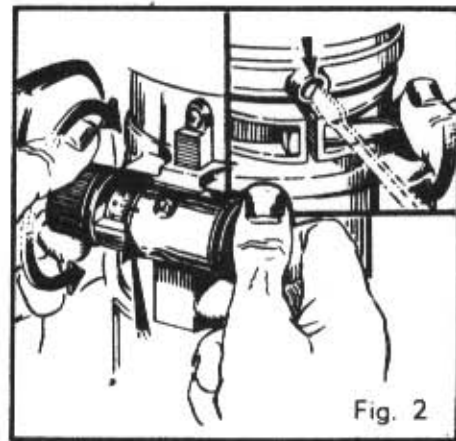

PROPER CARE OF CUTTERS—The best results for fast accurate cutting are obtained by using cutters which are sharp. A properly sharpened cutter will not only prolong the life of the router but will make the job of cutting both faster and easier.

Keep cutters clean. Avoid, if possible, running hot and smoking. Remove any accumulated pitch and gum from sides with kerosene.

If you are going to sharpen your own cutters, here is a recommended procedure. Grind only the inside of the cutting edge of cutters. When grinding cutters, it is sometimes necessary to touch up the end. Be sure, when grinding the end of cutters, to grind the clearance angle the same as that originally furnished on the cutters. Never grind the outside diameter of cutters as they are ground on special machinery for proper clearance.

ATTACHMENTS AND ACCESSORIES

Shown below are attachments and accessories that can be used with the **HEAVY DUTY ROUTER**. These items can be purchased through your local Sears store, or nearest Sears Catalog order house.

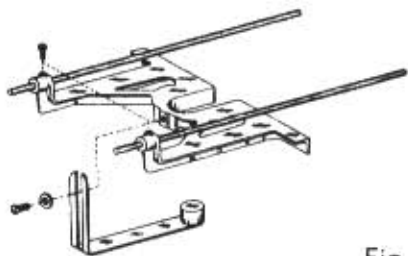

Fig. 3

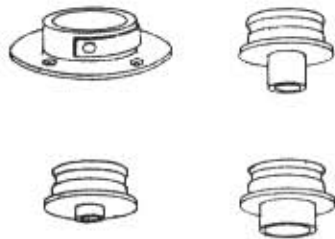

Fig. 4

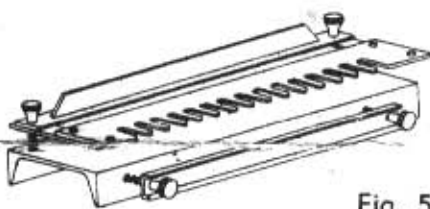

Fig. 5

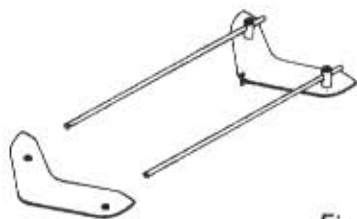

Fig. 6

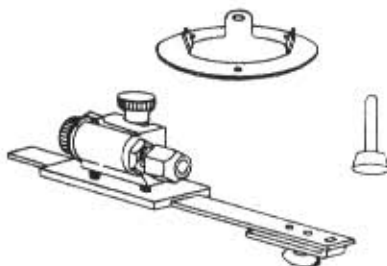

Fig. 7

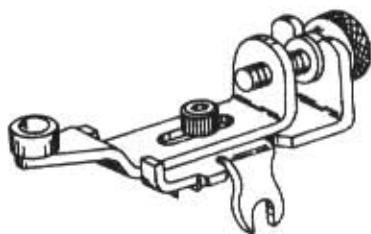

Fig. 8

FIG. 3, EDGE GUIDE AND CONTOUR FINGER CATALOG NO. 25163—

Used with "CRAFTSMAN" Heavy Duty Router for shaping edges when cutters having no pilots are employed, and for making all types of cuts required to be parallel to the edge of the work. When the contour finger is attached to the edge guide, and positioned under the cutter for the desired width and depth of cut it will enable the operator to rout a uniform cut on irregularly shaped edges.

FIG. 4, GUIDE BUSHINGS AND ADAPTER, NO. 25059—

The Adapter attaches to the router base. Afterwards, any one of three guide bushings furnished may be snapped into place in the adapter. The bushing circumference rides against a template edge to guide the bit for cutting. Since each of the three bushings has a different diameter, three different selections of spacing between the bit and template edge are available. $\frac{1}{2}$ " diameter bushing used with Dovetail Template (Fig. 5).

FIG. 5, DOVETAIL TEMPLATE, CATALOG NO. 2572—

For use in conjunction with Router and Guide Bushing, Figure 4, to make dovetail joints for joining drawer sides and ends. A template is a "must" for perfect fit of drawer sides and ends.

FIG. 6, TRAMMEL POINT ATTACHMENT NO. 25164—

This attachment can be used with the router to cut inside circles from 2" to 26" diameter, and can also be used for ~~many circular edge work~~.

FIG. 7, CUTTER GRINDING ATTACHMENT, NO. 25169—

The Cutter Grinding Attachment for the router makes light work of keeping bits and cutters sharp and in good condition. A special grinding wheel for use in the router chuck is included. The holding attachment has a full range of circular and angular adjustments so that you can accurately align any shape cutting edge with the grinding wheel surface. Once set up, the identical sharpening of all edges on a bit or cutter is assured.

FIG. 8, LAMINATED PLASTICS TRIMMER NO. 25731 —

Phenolics, laminated plastics and other laminates with similar bonding agents are much too hard to cut successfully with ordinary tools. This special router attachment, however, enables you to hold the thin sheets firmly for accurate cutting and edging. The special carboloy tipped bit included with this attachment will clean off the stubborn edges smoothly, without chipping or ripping.

DOOR AND JAMB BUTT HINGE TEMPLATES—

(Not shown) Most commercially available Door Butt Hinge Templates or Kits may be used with this router for making butt hinge seats in accurately hanging doors and shutters.

SEARS, ROEBUCK AND CO.—U.S.A.
IN CANADA, SIMPSONS-SEARS LIMITED