

Sears

CRAFTSMAN®

owners manual

DOVETAIL FIXTURE KIT

9 2570

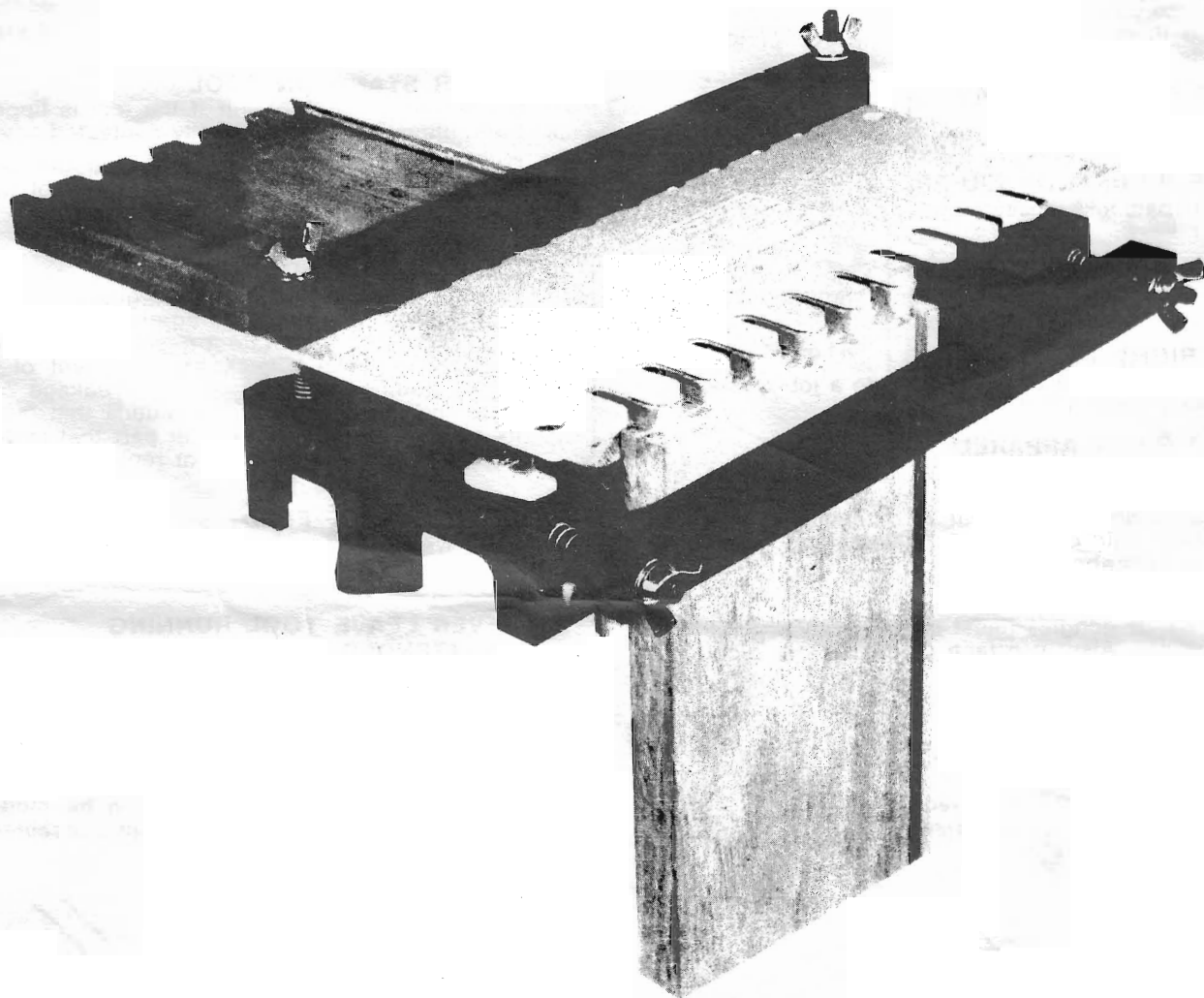

SOLD BY SEARS, ROEBUCK AND CO., CHICAGO, IL. 60684 U.S.A.

2/83 60523

Printed in U.S.A.

GENERAL SAFETY INSTRUCTIONS

FOR POWER TOOLS

1. KNOW YOUR POWER TOOL

Read the owner's manual carefully. Learn its application and limitations as well as the specific potential hazards peculiar to this tool.

2. GROUND ALL TOOLS (UNLESS DOUBLE INSULATED)

If tool is equipped with an approved 3-conductor cord and a 3-prong grounding type plug to fit the proper grounding type receptacle. The green conductor in the cord is the grounding wire. Never connect the green wire to a live terminal.

3. KEEP GUARDS IN PLACE

in working order, and in proper adjustment and alignment.

4. REMOVE ADJUSTING KEYS AND WRENCHES

Form habit of checking to see that keys and adjusting wrenches are removed from tool before turning it on.

5. KEEP WORK AREA CLEAN

Cluttered areas and benches invite accidents. Floor must not be slippery due to wax or sawdust.

6. AVOID DANGEROUS ENVIRONMENT

Don't use power tools in damp or wet locations or expose them to rain. Keep work area well lighted. Provide adequate surrounding work space.

7. KEEP CHILDREN AWAY

All visitors should be kept a safe distance from work area.

8. MAKE WORKSHOP KID-PROOF

— with padlocks, master switches, or by removing starter keys.

9. DON'T FORCE TOOL

It will do the job better and safer at the rate for which it was designed.

10. USE RIGHT TOOL

Don't force tool or attachment to do a job it was not designed for.

11. WEAR RIGHT APPAREL

Do not wear loose clothing, gloves, neckties or jewelry (rings, wrist watches) to get caught in moving parts. Nonslip footwear is recommended. Wear protective hair covering to contain long hair. Roll long sleeves above the elbow.

12. USE SAFETY GOGGLES (Head Protection)

Wear Safety goggles (must comply with ANS Z87.1) at all times. Also, use face or dust mask if cutting operation is dusty, and ear protectors (plugs or muffs) during extended periods of operation.

13. SECURE WORK

Use clamps or a vise to hold work when practical. It's safer than using your hand, frees both hands to operate tool.

14. DON'T OVERREACH

Keep proper footing and balance at all times.

15. MAINTAIN TOOLS WITH CARE

Keeps tools sharp and clean for best and safest performance. Follow instructions for lubricating and changing accessories.

16. DISCONNECT TOOLS

before servicing; when changing accessories such as blades, bits, cutters, etc.

17. AVOID ACCIDENTAL STARTING

Make sure switch is in "OFF" position before plugging in.

18. USE RECOMMENDED ACCESSORIES

Consult the owner's manual for recommended accessories. Follow the instructions that accompany the accessories. The use of improper accessories may cause hazards.

19. NEVER STAND ON TOOL

Serious injury could occur if the tool is tipped or if the cutting tool is accidentally contacted.

Do not store materials above or near the tool such that it is necessary to stand on the tool to reach them.

20. CHECK DAMAGED PARTS

Before further use of the tool, a guard or other part that is damaged should be carefully checked to ensure that it will operate properly and perform its intended function. Check for alignment of moving parts, binding of moving parts, breakage of parts, mounting, and any other conditions that may affect its operation. A guard or other part that is damaged should be properly repaired or replaced.

21. DIRECTION OF FEED

Feed work into a blade or cutter against the direction of rotation of the blade or cutter only.

22. NEVER LEAVE TOOL RUNNING UNATTENDED

Turn power off. Don't leave tool until it comes to a complete stop.

IMPORTANT INSTRUCTIONS

It is important that you read the following instructions completely before attempting to use your Dovetail Fixture.

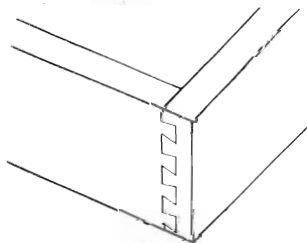

1/2" FLUSH JOINT
FIG. 1

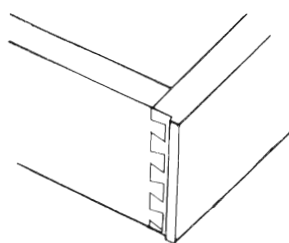

1/2" FLUSH-OFFSET JOINT
FIG. 2

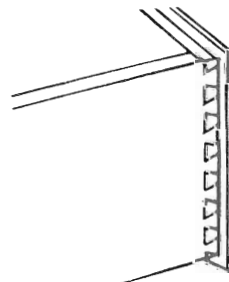

1/2" RABBETED JOINT
FIG. 3

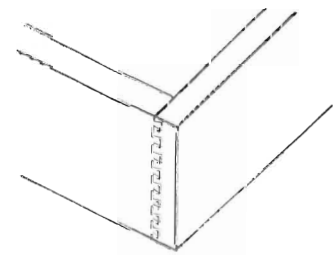

1/4" FLUSH JOINT
FIG. 4

Four different style dovetail joints can be made very easily with your dovetail fixture kit and router. These are described below.

1. The $\frac{1}{2}$ " Flush joint is used where the drawer front is the same height as the drawer sides, and the drawer front is the same length as the drawer is wide (See Fig. 1).
2. The $\frac{1}{2}$ " Flush-Offset is used where the drawer front is the same height as the drawer sides and the drawer front is $\frac{1}{8}$ " longer than the width of the drawer. (The drawer sides are recessed into the drawer front $1/16$ " — See Fig. 2).
3. The $\frac{1}{2}$ " Rabbeted joint is used when the drawer front is to overlap the opening for the drawer on both sides, the top and the bottom. The drawer

front is $\frac{3}{4}$ " wider than the drawer sides and the drawer front is $\frac{3}{4}$ " longer than the width of the drawer. (See Fig. 3).

4. The $\frac{1}{4}$ " Flush joint is the same as the $\frac{1}{2}$ " Flush except that the dovetails are much smaller. The $\frac{1}{4}$ " joint is usually used for very small drawers such as in jewelry chests, silverware chests, gun boxes, etc. (See Fig. 4).

Now refer to Fig. 5 and become familiar with the names of the various parts of your dovetail fixture. This will make the following instructions much easier to understand in the event that you are presently unfamiliar with dovetail joints.

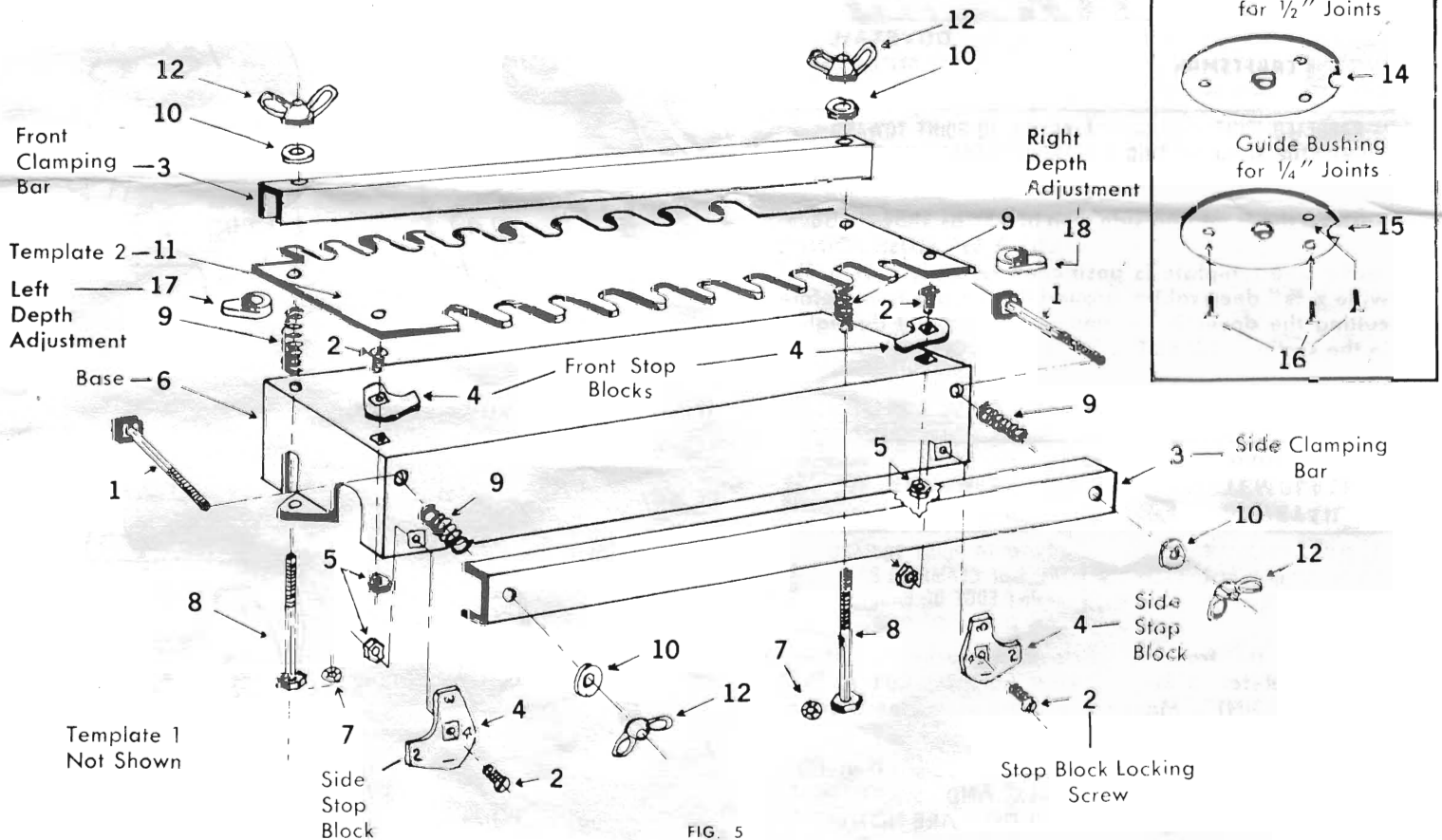

FIG. 5

TEMPLATES:

This fixture is furnished with two templates:

Dovetail Template 1 is used for $\frac{1}{2}$ " rabbeted joints and $\frac{1}{4}$ " flush joints; Dovetail Template 2 is used for $\frac{1}{2}$ " flush joints and $\frac{1}{2}$ " flush-offset joints.

The fixture is assembled with Template 2 positioned so $\frac{1}{2}$ " flush joints can be cut.

Each template is identified by "Dovetail Template 1" or "Dovetail Template 2" on the top surface. Additionally, information on the joints that can be cut and the stop block settings for these joints is also provided. ~~The template surface with this information MUST ALWAYS FACE UPWARD~~ when the template is positioned on the fixture. That is, the information panel must be visible.

Additionally, an arrow on this panel shows the direction the template must point for a particular joint, that

is to the front edge of the base (key 6, fig. 5) where the side clamping bar (key 3, fig. 5) is located.

To change or reposition templates, remove the wing nuts, washers, and front clamping bar (keys 12, 10, and 3, fig. 5). Lift template (key 11, fig. 5) from fixture and reposition or change to the other template. When placing the template on the fixture make sure the depth adjustment with an "R" (key 18, fig. 5) is on the right side and the depth adjustment with an "L" (key 17, fig. 5) is on the left side, or else dovetails will not line up properly. (The depth adjustments have an "R" or an "L" molded on the back of the tab for identification). Make sure the raised diameter on the depth adjustments fits into the hole in the template.

NOTE: THE DEPTH ADJUSTMENTS ARE USED WHEN CUTTING ALL THREE $\frac{1}{2}$ " JOINTS AND ARE NOT USED FOR THE $\frac{1}{4}$ " JOINT.

Reassemble the front clamping bar, washers, and wing nuts to the fixture.

MOUNTING: The fixture must be securely fastened to a work bench or table of good rigidity by bolts or screws through the holes of the foot pads at each end of the base. When positioning the base, be sure that the front edge of the base overhangs the edge of the work bench or table on which the base is mounted by approximately $\frac{1}{32}$ ". (The drawer sides will extend downward when clamped in the fixture).

Preparing drawer front and sides: The drawer front should be cut to the finished size — (both length and width). The drawer sides should be cut to finished width, however, they may be left longer if you desire, and cut to correct length later. Be sure the ends are cut square. It is recommended that trial cuts be made on short lengths of wood to be sure you are getting the desired joint.

TO CUT A $\frac{1}{2}$ " FLUSH JOINT (FIG. 1) USE TEMPLATE 2

Sears **CRAFTSMAN.**

U.S. PAT. NOS.
3800840
3834435

**DOVETAIL
TEMPLATE 2**
MADE IN U.S.A.

$\frac{1}{2}$ " FLUSH JOINT
FRONT STOP BLOCK SETTING 2
SIDE STOP BLOCK SETTING 4

ARROW TO POINT TOWARD
THE SIDE CLAMPING BAR
(FRONT EDGE OF BASE)

1. Position the front and side, stop blocks as shown above. The drawer front stop blocks are positioned by loosening the screw about two turns and rotating the block. Tighten the screw snugly after the block is in the desired position. The screws for the front blocks may be reached through the holes in the template immediately above the screws, if you have a small screwdriver. **DO NOT FORCE A LARGE SCREWDRIVER THROUGH THESE HOLES AS IT MAY CAUSE THE HOLES TO BECOME ENLARGED. THIS WOULD CAUSE IMPROPER FUNCTION WHEN CUTTING DOVETAIL JOINTS.** If you do not have a small screwdriver, the template should be removed to provide access to the screws. Make sure template is positioned correctly.

2. Loosen wing nuts (Key 12, Fig. 5) until they are just at the ends of bolts (Key 8). Position tabs on both depth adjustments so they line up with front clamping bar, as shown in Fig. 10. This is done

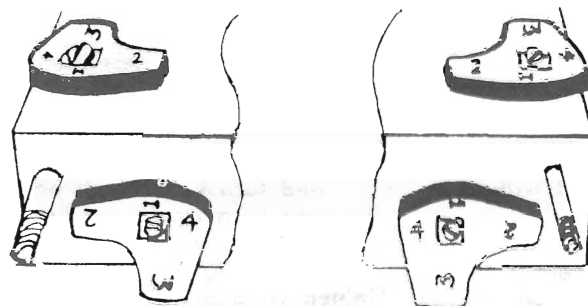

by turning tabs either clockwise or counterclockwise. A slight ratcheting effect will be felt as the depth adjustment passes through various positions. **DO NOT ATTEMPT TO MAKE THIS, OR ANY, CHANGE TO DEPTH ADJUSTMENT WITH WORK PIECE CLAMPED IN FIXTURE OR WITHOUT LOOSENING WING NUTS AS DESCRIBED ABOVE. FAILURE TO DO THIS CAN RESULT IN DAMAGE TO DEPTH ADJUSTMENT FEATURE.**

3. Place the drawer side and front in the fixture as shown in Fig. 7. The drawer side and front must be against the stop blocks and the end of the drawer side must be flush with the top surface of the drawer side front. Tighten all wing nuts to clamp drawer side and front to fixture.

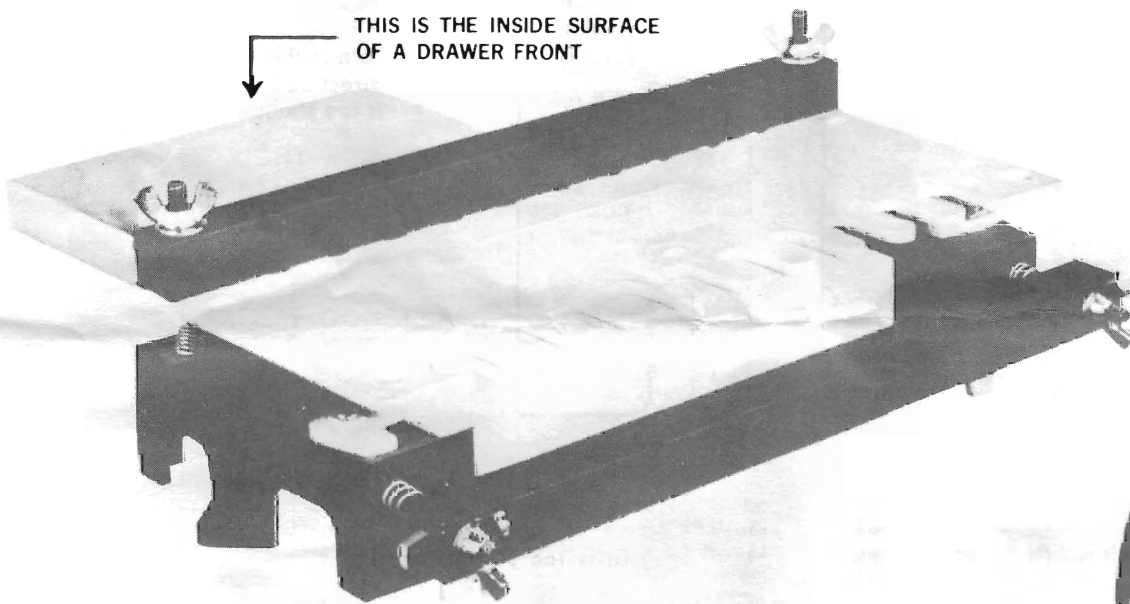

THIS IS THE INSIDE SURFACE
OF A DRAWER FRONT

THIS IS THE INSIDE SURFACE
OF A DRAWER SIDE

FIG. 7

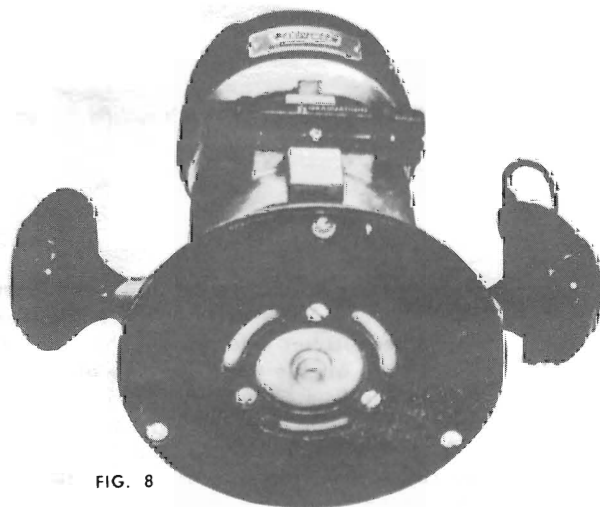
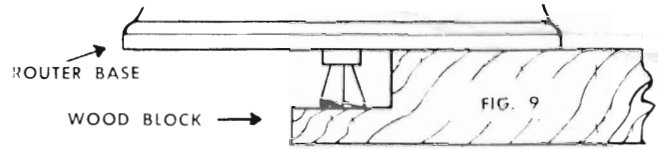

FIG. 8

- Attach the guide bushing which has the largest pilot to the router base with the three flat head screws as shown in Fig. 8.
- Insert a $\frac{1}{2}$ " Dovetail router bit (Cat. #9-25531) in router as shown. The end of the router bit should extend $\frac{1}{2}$ " beyond the base of the router. This setting will be approximately correct. If the joint is too loose, the bit should be extended about $\frac{1}{64}$ " or $\frac{1}{32}$ " and another trial cut made. If the joint is too tight, the extension of the bit should be de-

CUT SQUARE NOTCH IN WOOD BLOCK TO JUST TOUCH THE END OF THE BIT WHEN BLOCK IS RESTING ON THE SURFACE OF THE ROUTER BASE.

creased $\frac{1}{64}$ " to $\frac{1}{32}$ " and another trial cut made. Joints can be made tighter or looser in this manner. When you have this set correctly to give the desired fit of the joint, it is suggested that you make a simple gage from a block of wood which will help to set this dimension quickly in the future. (See Fig. 9).



- If fit is too shallow (Fig. 11), loosen wing nuts as described in Step 2 and turn both depth adjustments an equal amount in a clockwise direction (Fig. 10). One ratchet "click" will make the depth of cut in the drawer front (Fig. 7) approximately $\frac{1}{64}$ " deeper. Tighten wing nuts before making cut. If fit is too deep (Fig. 11), loosen wing nuts as described in Step 2 and turn both depth adjustments an equal amount in a counterclockwise direction (Fig. 10). One ratchet "click" will make the depth of cut in the drawer front (Fig. 7) approximately $\frac{1}{64}$ " shallower. Tighten wing nuts before making cut. A number of trial cuts may be necessary to obtain the correct depth of cut.

- Place the router base on the template and make the cut with the guide bushing following the template. Always keep the router held down flat on the template and when the cut is finished, pull the router forward off of the template. NEVER LIFT THE ROUTER UPWARDS WHEN THE GUIDE BUSHING IS NEAR OR TOUCHING THE TEMPLATE AS THIS WILL CAUSE THE BIT TO CUT AND RUIN THE TEMPLATE.

Before unclamping the parts, look at the cut to be sure the cut looks uniform. Sometimes the router does not go all the way back until the guide bushing touches the stop plate. If this is visibly noticeable, retrace the cut in the area that did not look uniform.

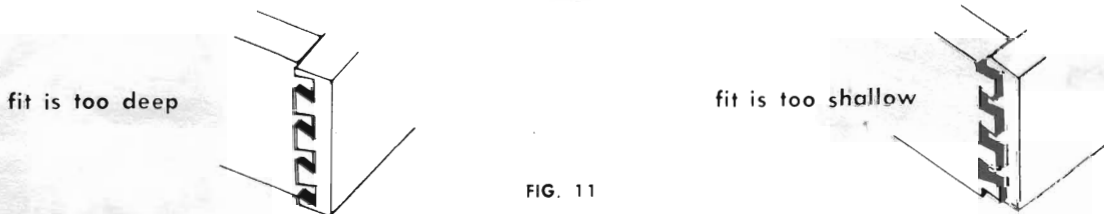
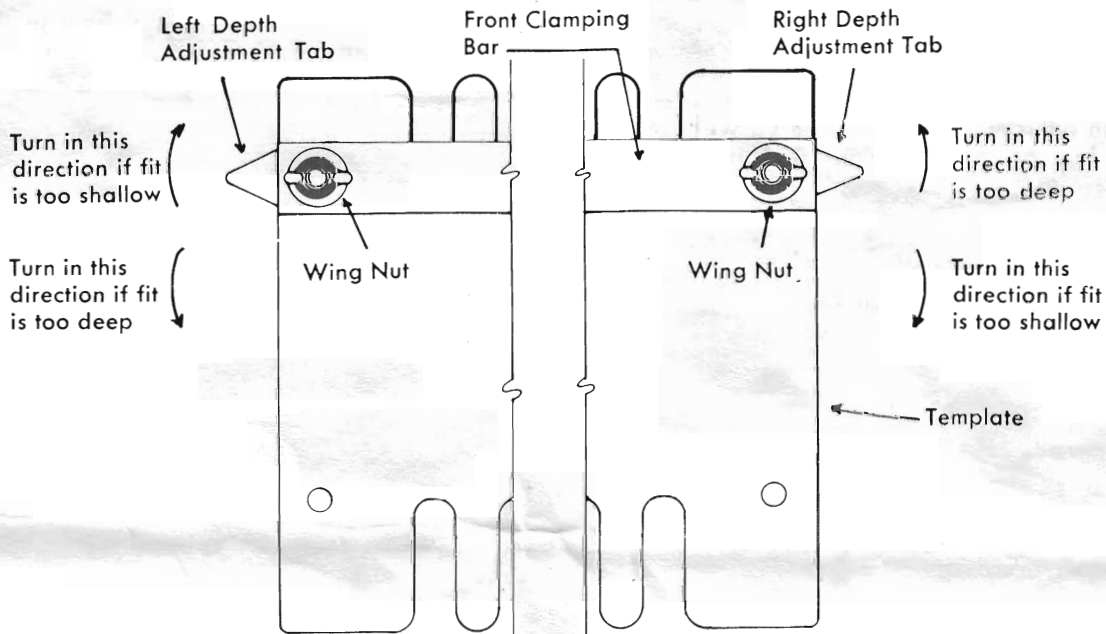

- Remove the drawer side and front from the fixture. Reverse ends of the drawer front and taking the other drawer side, mount the side and front in the fixture on the opposite side of the fixture from where the first cut was made; i.e. if you made the first cut on the left side of the fixture, the other end of the drawer front and the other side must be cut on the right side of the fixture. After making the second cut, the drawer front joints are com-

pleted.

- If the back of the drawer is also to be dovetailed to the drawer sides, the sides must be cut to the proper length before cutting the dovetail. Joints made on the left end of the fixture are for left front or right rear corner of a drawer or box. To make joints for right front or left rear corners, use the right hand end of the fixture.

TO CUT A 1/2" FLUSH-OFFSET JOINT (FIG. 2) USE TEMPLATE 2

MADE IN U.S.A. 3834435
TEMPLATE 2
DOVETAIL

U.S. PAT. NOS. 3800840 3834435
CRAFTSMAN Sears

1/2 FLUSH-OFFSET JOINT
 FRONT STOP BLOCK SETTING 2
 SIDE STOP BLOCK SETTING 4

ARROW TO POINT TOWARD THE SIDE CLAMPING BAR (FRONT EDGE OF BASE)

Position the front and side stop blocks as shown above. Refer to Step 1 in section "TO CUT A 1/2" FLUSH JOINT". Make sure template is positioned correctly. Continue as in Steps 2 through 9 in the section "TO CUT A 1/2" FLUSH JOINT."

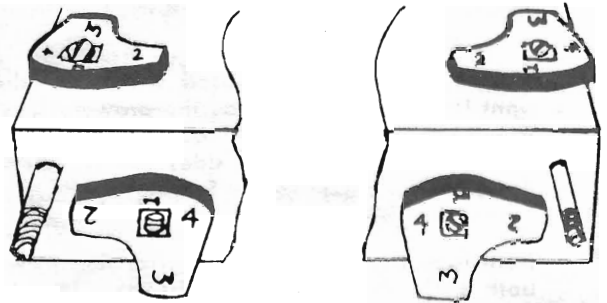

TO CUT A 1/2" RABBETED JOINT (FIG. 3) USE TEMPLATE 1

MADE IN U.S.A. 3834435
TEMPLATE 1
DOVETAIL

U.S. PAT. NOS. 3800840 3834435
CRAFTSMAN Sears

1/2 RABBETED JOINT
 FRONT STOP BLOCK SETTING 1
 SIDE STOP BLOCK SETTING 4

ARROW TO POINT TOWARD THE SIDE CLAMPING BAR (FRONT EDGE OF BASE)

Position the front and side stop blocks as shown above. Refer to Step 1 in section "TO CUT A 1/2" FLUSH JOINT". Make sure template is positioned correctly. Cut a 3/8" wide x 3/8" deep rabbet around the drawer front before cutting the dovetail. Continue as in Steps 2 through 9 in the section "TO CUT A 1/2" FLUSH JOINT".

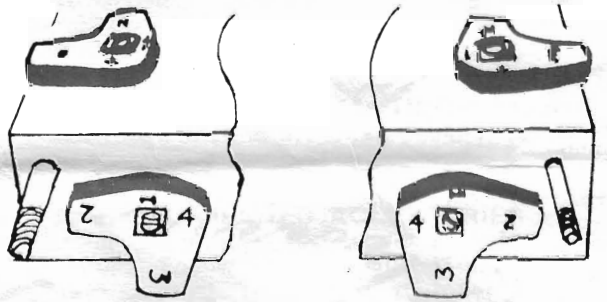

TO CUT A 1/4" FLUSH JOINT (FIG. 4) USE TEMPLATE 1

MADE IN U.S.A. 3834435
TEMPLATE 1
DOVETAIL

U.S. PAT. NOS. 3800840 3834435
CRAFTSMAN Sears

1/4 FLUSH JOINT
 FRONT STOP BLOCK SETTING 3
 SIDE STOP BLOCK SETTING 1

ARROW TO POINT TOWARD THE SIDE CLAMPING BAR (FRONT EDGE OF BASE)

1. Position the front and side stop blocks as shown above. Refer to Step 1 in section "TO CUT A 1/2" FLUSH JOINT". Make sure template is positioned correctly.

NOTE: DEPTH ADJUSTMENTS CANNOT BE USED WHEN CUTTING 1/4" DOVETAILES AND SHOULD BE KEPT IN A SAFE PLACE SO THEY ARE NOT LOST.

2. Loosen wing nuts (key 12, fig. 5) until they are just at the ends of the bolts (key 8). Continue as in Step 3 in section "TO CUT A 1/2" FLUSH JOINT".

3. Attach the guide bushing which has the smallest pilot to the router base with the three flat head screws as shown in fig. 8.

NOTE: When cutting 1/4" Dovetails it is necessary that you use a "Craftsman" No. 2 2553 bit which looks like the one shown below. Note small necked down area for clearance. Because of the small space in 1/4" joints, it is also very im-



2 2553 1/4" Dovetail Bit

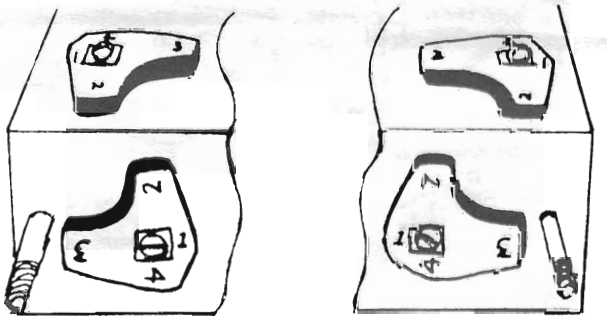

portant to keep the chips cleaned out of the space between the bit and the hole through the guide bushing. This will prevent heat and chips from wearing the guide bushing out prematurely. Use of the type bit shown here provides more space for chips than other types of 1/4" dovetail bits.

4. Insert a 1/4" dovetail router bit (cat. #9-2553) in the router as shown in fig. 9. The end of the router bit should extend 11/32" beyond the base of the router.

5. Continue as in Step 4 and Steps 7 through 8 in section "TO CUT A 1/2" FLUSH JOINT". Step 6 is omitted because the depth adjustments are not used in cutting 1/4" dovetails.

WHEN REQUESTING INFORMATION ALWAYS GIVE THE FOLLOWING INFORMATION AS SHOWN IN THIS LIST.

1. The KEY NUMBER
2. The PART DESCRIPTION
3. The MODEL NUMBER — 720. 2570
4. The NAME of ITEM — DOVETAIL FIXTURE KIT