

CRAFTSMAN

POWER TOOLS

COMPLETE
LINE OF
1950 MODELS



SEARS, ROEBUCK AND CO.

SATISFACTION GUARANTEED OR YOUR MONEY BACK

SEARS EASY PAYMENT PLAN

"I equipped a complete shop with only
a small down payment on Sears Easy Terms"

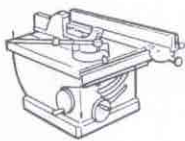
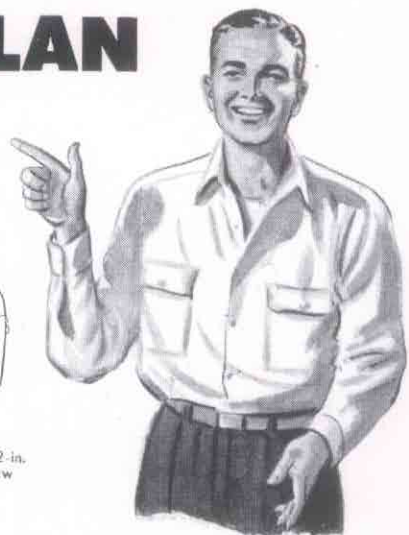

CRAFTSMAN "100"
8-in. Tilting Arbor Saw
as little as
\$8.00 Down.



CRAFTSMAN "80"
Ball-Bearing Drill Press
as little as
\$6.50 Down

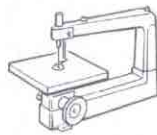

CRAFTSMAN "80"
18-inch Jig Saw
as little as
\$3.00 Down

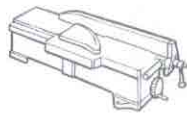

CRAFTSMAN "80"
4 3/4-in. Jointer Planer
as little as
\$4.00 Down

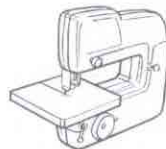

CRAFTSMAN "100" 12-in.
Three-Wheel Band Saw
as little as
\$4.50 Down

Only a 10% down payment
.. terms as low as \$5 a month

Yes, it is actually possible to equip a complete power tool workshop for only a few dollars down on Sears Easy Payment Plan. There's no need to buy the tools for your shop one at a time in a hit-or-miss fashion, just because you don't happen to have the ready cash or don't wish to disturb your savings. You can carefully plan your shop and buy all the tools you need NOW... all at one time... and pay for the shop while you are using it. Above, you will find a few examples of the small down payments necessary to buy power tools from this catalog.

You can buy anything in this catalog on Easy Terms if your purchase totals \$20 or more. It takes only a 10% down payment with your purchase, and the balance in convenient monthly payments. See the table at right for the amount of monthly payments. Any of our sales people will be glad to give you further information.

If unpaid balance amounts to	We shall add for Easy Payments	Amount monthly is	If unpaid balance amounts to	We shall add for Easy Payments	Amount monthly is
Up to \$ 22.00	\$1.75		\$120.01 to \$130.00	\$12.00	
\$22.01 to 24.00	2.00		130.01 to 140.00	13.00	\$10.50
24.01 to 26.00	2.25		140.01 to 150.00	13.50	
26.01 to 28.00	2.50		150.01 to 160.00	14.00	11.00
28.01 to 30.00	2.75		160.01 to 170.00	14.50	
30.01 to 33.00	3.00	\$5.00	170.01 to 180.00	15.50	12.00
33.01 to 36.00	3.30		180.01 to 190.00	16.50	
36.01 to 40.00	3.60		190.01 to 200.00	17.50	13.00
40.01 to 45.00	4.00		200.01 to 210.00	18.00	
45.01 to 50.00	4.50		210.01 to 220.00	19.00	13.50
50.01 to 55.00	5.00		220.01 to 230.00	20.00	14.00
55.01 to 60.00	5.50	6.00	230.01 to 240.00	21.00	14.50
60.01 to 65.00	6.00		240.01 to 250.00	22.00	15.00
65.01 to 70.00	6.50	7.00	250.01 to 260.00	23.00	16.00
70.01 to 75.00	7.00		260.01 to 270.00	24.00	16.50
75.01 to 80.00	7.50		270.01 to 280.00	24.50	17.00
80.01 to 85.00	8.00	8.00	280.01 to 290.00	25.00	17.50
85.01 to 90.00	8.50		290.01 to 300.00	26.00	18.50
90.01 to 95.00	9.00	9.00			
95.01 to 100.00	9.50				
100.01 to 110.00	10.00	10.00			
110.01 to 120.00	11.00				

For balances over \$300 consult any Sears salesperson

INDEX

Page	Page
Abrasives.....7, 40, 41	Jointer Planers.....12
Arbors.....17, 19, 21, 23, 24, 25	Lathes.....16, 17, 19 to 23
Band Saws and Blades.....8	Lineshaft Accessories.....43
Belts and Belting.....43	Mandrels.....6
Bench Saws and Bench Saw	Miter Gauges.....6
Accessories.....1, 2, 3	Motors, Electric.....36, 37
Buffing Equipment.....7, 40, 41	Patterns, Easi-Bild.....47
Builders' Saws.....4	Planers.....12, 13
Centers.....16, 17, 19, 20, 21, 22, 23, 25	Polishing Equipment.....7, 40, 41
Chucks.....16, 17, 19 to 25, 29	Polishing Heads.....39
Clamps.....48	Precision Tools.....31
Cut-off Wheels.....7, 41	Pulleys.....42
Dado Sets.....7	Rotary Electric Tools.....33
Drill Presses and Drill Press	Sanders.....9, 14, 15
Accessories.....26 to 30	Sanding Equipment.....7, 40, 41
Drills.....34, 35, 48, 49	Saw Blades.....7
Electric Drills.....34, 35	Screwdrivers.....49
Electric Hand Saws.....5	Shapers.....9
Electric Motors and Motor	Shaper Cutters.....9
Accessories.....36, 37	Soldering Irons.....45
Flexible Shafts.....32, 33	Swing Saws.....6
Glue.....40	Thickness Planers.....13
Grinders.....38, 39	Thread Cutters, Power.....18
Grinding Wheels.....38	Tool Lights.....48
Hack Saws, Power.....21	"V" Belts and Belting.....43
Hammers.....48	Vises.....18
Jack Shafts.....17	Welders (Arc and Acetylene) and
Jig Saws and Blades.....10, 11	Accessories.....44, 45, 46

SEARS GUARANTEE

- TO DELIVER ALL MERCHANDISE SAFELY
- TO SATISFY YOU PERFECTLY

We guarantee that every article in this catalog is honestly described and illustrated. We guarantee that any article purchased from us will give you the service you have a right to expect.

If for any reason whatever you are not satisfied with any article purchased from us, we want you to return it to us.

We will then exchange it for exactly what you want, or will return your money.

SEARS, ROEBUCK AND CO.

NOTICE ABOUT PRICES

We reserve the right to change the price of any item in this catalog if it becomes necessary to do so.

Furthermore, should the Federal Government or any State increase by taxes or otherwise the cost or selling price of any of the merchandise shown in this book, we reserve the right to add such taxes or other increases of cost or selling to the prices shown.

The prices shown in this catalog are good for the continental United States only.

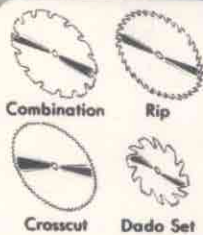

Extra 8-inch rip, cross-cut and combination blades, and dado sets, for use on this saw are listed on page 7 of this catalog.

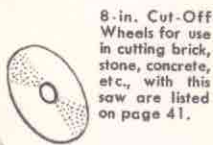

8-in. Cut-Off Wheels for use in cutting brick, stone, concrete, etc., with this saw are listed on page 41.

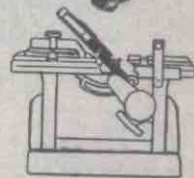

Blade tilts any angle up to 45°. Work is always level to assure easier and more accurate work.

Without motor **\$54.50** CASH
\$5.50 DOWN .. ON EASY TERMS

CRAFTSMAN
 REG. U. S. PAT. OFF.

"80" Tilting Arbor Bench Saw

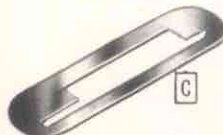
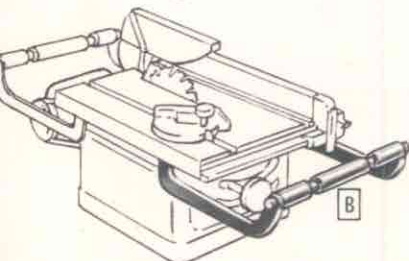
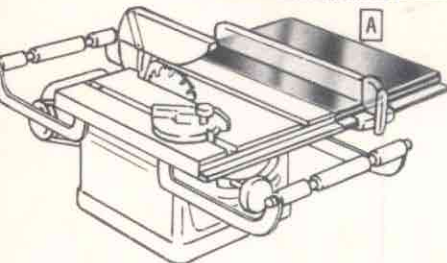

- A brand new design! Has many quality features you'll find in no other tilting arbor bench saw on the market.
- Double-row, sealed precision ball bearings . . . permanently lubricated at factory . . . need no further lubrication—ever!

This superb heavy duty Bench Saw is entirely new in every way. New design . . . new construction . . . new features . . . CRAFTSMAN quality. We know of no other tilting arbor bench saw at any price which will give more accurate performance. This exceptional accuracy is due to special features and the very close machining tolerances maintained in its manufacture. Easily meets the most rigid requirements of amateur and professional craftsmen and large woodworking shops.

Three important exclusive features. (1) Tilting, raising and lowering of blade all controlled by ONE hand wheel. (2) Floating motor mount automatically controls belt tension. (3) Motor is attached to special support on bench behind saw, for smoother operation, easier tilting, and greater protection for motor from sawdust. Eliminates necessity for using special enclosed type motor.

Big 20x17-inch smooth ground table of heavy cast semi-steel. Has removable insert for dadoing or sanding. Grooved on both sides of blade for use of miter gauge.

Quick-acting rip fence locks at both ends with one handle. Alignment of fence is assured at all times because control surface locks against front of table rather than against a guide bar. Fence can be used on either side of blade.

Many other quality features. Because of a special mechanical arrangement, arbor is tilted more rapidly than on ordinary tilting arbor saws, without loss of accuracy.

Automatic leveling guard tilts with blade; has non-kickback pawls and splitter. Accurate gauges show depth and angle of cut. Has built-in sawdust chute. Accurate miter gauge included. Has many other features and refinements in design which we don't have the space to describe here.

SPECIFICATIONS:

- Depth of cut, maximum 2 1/4 inches
- Table size 20x17 inches
- Dado capacity (maximum, with 6-inch head)
 Width 1 3/8 inch Depth 1 3/8 inches
- Blade (combination type)
 Size 8-inch diameter Bore 1/2 inch
- Bearings Double row precision ball bearings
- Recommended arbor speed (approx.) 4500 R.P.M.
- Motor recommended (min.) 1/2-H.P. 3450 R.P.M.
- Machine pulley (included) 2 inches
- Motor pulley (not included) 2 3/8 inches
- Mounting dimensions (bolt holes) 11 1/16x11 1/16 inches (extremes of saw and motor brackets) 19 1/16x15 1/16 in.
- Over-all dimensions: Height 14 7/8 inches; width 17 inches; length 26 7/16 inches.

99 AM 2383—Without motor. Shpg. wt. 72 lbs. \$54.50

99 AM 2398—With 1/2-H.P. 3450 R.P.M. ball bearing capacitor motor for 110-120 volt 60-cycle A.C.; 2 3/8-inch motor pulley; and 1/2x40-inch V-belt. Shpg. wt. 109 lbs. \$83.50

High Quality Accessories for Above Bench Saw

- A Side Table Extension.** Cast semi-steel. 20x17 in. Makes total table size 34x20 in. Bolts to regular saw table. Includes rip fence guide bar extension and fittings.
 9 A 2358—Shipping weight 37 pounds \$15.00
- B Front or Rear Table Extension.** New roller type extension which increases capacity of table without disturbing the rip fence set-up on the saw.
 9 A 2356—Shipping weight 7 lbs. 8 oz. \$4.75

- C Dado Insert.** For use on the saw shown above, when doing dado work. Strongly made of steel.
 9 A 2405—Shipping weight 10 ounces 80c
- D Instruction Book.** "The Circular Saw." A handy 32-page instruction book with over 150 illustrations, showing you how to get the most out of your bench saw, electric hand saw, swing saw, builders' saw and radial saw.
 9 A 2926—Shipping weight 2 ounces 35c

DUNLAP 8-inch

OUR OWN TRADE MARK

Tilting Table Saw

A This new DUNLAP 8-inch Bench Saw has rugged, heavy duty construction throughout. Massive cast semi-steel base encloses mechanism. Notice the extra table size... extra capacity.

16 $\frac{1}{2}$ x12 $\frac{1}{4}$ -inch cast semi-steel table tilts 0 to 45 degrees. Grooved on both sides of blade for mitering. Has removable insert for dadoing. Accurate angle gauge. Self-lubricating porous bronze bearings with oil reservoirs around each.

Self-aligning rip fence may be used on either side of blade. Adjustable guard, accurate miter gauge, splitter, rip fence, and combination blade included. See below for table extension.

SPECIFICATIONS:

- Depth of cut, maximum.....2 $\frac{1}{4}$ inches
- Blade.....8-inch combination type with $\frac{1}{8}$ -inch bore
- Table size.....16 $\frac{1}{2}$ x12 $\frac{1}{4}$ inches
- Table size with extensions (not included).....23 $\frac{3}{8}$ x16 $\frac{1}{8}$ inches
- Dado capacity, maximum, with 6-inch head:
 - width..... $\frac{1}{8}$ in.; depth.....1 $\frac{1}{2}$ in.
- Bearings.....Self-lubricating porous bronze
- Recommended arbor speed (approximate).....4500 R.P.M.
- Motor recommended, minimum..... $\frac{1}{2}$ -H.P. 1750 R.P.M.
- Machine pulley (included).....2 inch
- Motor pulley (not included).....5 inch
- Mounting dimensions.....11 $\frac{1}{8}$ x6 $\frac{3}{8}$ inches
- Over-all dimensions: Height 15 inches; width 12 $\frac{1}{4}$ inches; length 20 $\frac{1}{8}$ inches

99 A 02288—Without motor. Shipping wt. 60 lbs.....\$34.50

99 AM 2382—With $\frac{1}{2}$ -H.P. 1750 R.P.M. capacitor ball bearing motor for 110-120 volt A.C., 5-inch motor pulley, $\frac{1}{2}$ x42-inch V-belt.....\$61.00

Shipping weight 95 pounds.



A
Without motor **\$34⁵⁰** CASH
\$3.50 DOWN... ON EASY TERMS

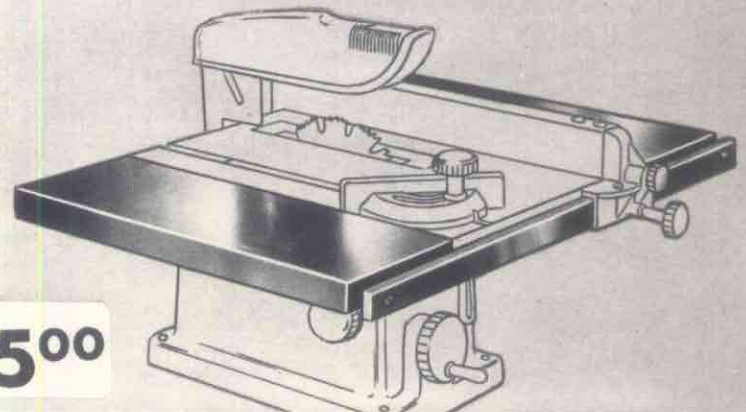

Table tilts 0 to 45°. Efficient gear mechanism raises and lowers it on two heavy columns.

Table Extension

B Designed for use with the DUNLAP 8-inch Saw above. Increases the total working surface of saw table from 16 $\frac{1}{2}$ x12 $\frac{1}{4}$ inches to 23 $\frac{3}{8}$ x16 $\frac{1}{8}$ inches. Set consists of two smooth stamped steel side extensions, each 5 $\frac{1}{2}$ x16 $\frac{1}{8}$ inches in size, plus all necessary support bars and fittings for attaching extensions to saw. One extension is mounted on each side of table. Rip fence can be used over the entire length of the extensions. Easily installed.

9 A 2174—Shipping weight 7 pounds 4 ounces.....\$5.00



B
\$5⁰⁰

DUNLAP 7-inch

OUR OWN TRADE MARK

Tilting Table Saw

C You'd expect to pay much more for a well-made, efficient bench saw like this. An ideal saw for home or small workshop use. Notice the safe, fully enclosed design.

14 $\frac{1}{2}$ x10 $\frac{1}{8}$ -inch cast semi-steel table tilts 0 to 45°. Efficient ball crank and gear mechanism raises and lowers table to adjust depth of cut. Accurate depth of cut and angle gauges. Self-lubricating porous bronze bearings with oil reservoirs around each.

Self-aligning rip fence may be used on either side of blade. Adjustable guard, accurate miter gauge, splitter, rip fence and blade are included with this saw.

SPECIFICATIONS:

- Depth of cut, maximum.....2 $\frac{1}{4}$ inches
- Blade.....7-inch plain tooth combination blade with $\frac{1}{8}$ -inch bore
- Table size.....14 $\frac{1}{2}$ x10 $\frac{1}{8}$ inches
- Extensions.....Not available
- Dado capacity, maximum, with 6-inch head:
 - width..... $\frac{1}{8}$ in.; depth.....1 $\frac{1}{2}$ in.
- Bearings.....Self-lubricating porous bronze
- Recommended arbor speed (approximate).....4500 R.P.M.
- Motor recommended, minimum..... $\frac{1}{2}$ -H.P. 1750 R.P.M.
- Machine pulley (included).....1 $\frac{1}{2}$ inch
- Motor pulley (not included).....4 inch
- Mounting dimensions.....9 $\frac{5}{8}$ x4 $\frac{3}{8}$ inches
- Over-all dimensions.....Height 11 $\frac{1}{2}$ inches; width 10 $\frac{1}{8}$ inches; length 17 $\frac{3}{8}$ inches.

99 A 02169—Without motor. Shipping wt. 36 lbs.....\$23.50

99 AT 2191—With $\frac{1}{2}$ -H.P. 1750 R.P.M. split phase bronze bearing motor for 110-120 volt A.C., 4-inch motor pulley, $\frac{1}{2}$ x40-inch V-belt. Shipping weight 63 pounds.....\$36.50



C
Without motor **\$23⁵⁰** CASH
\$2.50 DOWN... ON EASY TERMS

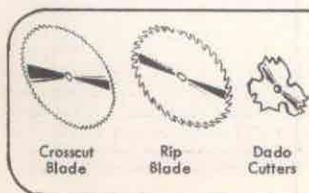

7-inch and 8-inch replacement blades and dado cutters for saws on this page can be found on page 7 of this catalog.



The blade, guard, arbor and motor are mounted on the rugged carriage that rolls smoothly on 6 ball bearing rollers . . . All working parts are below the table surface . . . out of the way

With-
out
Motor **\$9350** CASH
\$950 DOWN . . ON
EASY TERMS

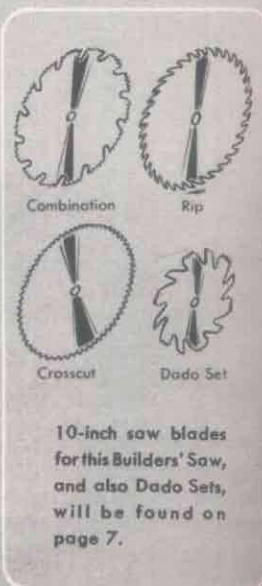

10-inch saw blades for this Builders' Saw, and also Dado Sets, will be found on page 7.

CRAFTSMAN "100" Builders' Saw

Faster . . easier . . lumber remains stationary while saw blade is pulled through

You'll get an entirely new idea of sawing efficiency when you use this great CRAFTSMAN Builders' Saw. It makes possible much easier and more accurate work because lumber remains stationary, and you easily move the whirling blade through it. No more sliding of long, heavy lumber into the blade on difficult crosscutting jobs.

Can also be used as regular circular saw by locking blade. Can be used for crosscutting, ripping and mitering—and even dadoing with proper attachments. Ideal for builders, contractors, factories, farmers, home craftsmen, etc. Cuts and rips building materials; cuts crating in shipping rooms, etc.

Extra large capacity. The 10-inch combination rip and crosscut blade allows you to make cuts up to 3 inches in depth. Saw travels full 15½ inches. At any point in blade travel the depth of cut can be easily adjusted by the large handwheel. Removable and adjustable saw guard raises and lowers with blade.

Heavy duty construction. Will stand up under steady production use. Sturdy steel frame, legs, and side panels welded into one solid unit. 35x24-inch table top is one-piece steel, stamped and coined. Sturdy ribbing braces are welded to undersides. Table has removable insert for dadoing, sanding, etc.

Two miter gauges. Left hand gauge is used when work is stationary and blade is pulled through. Right hand gauge is used when blade is stationary for small cuts. Rip fence locks at both ends for greater accuracy; Arbor is mounted on two roller type needle bearings.

SPECIFICATIONS:

- Depth of cut, maximum 3 inches
- Blade, combination type 10-inch diameter
¾-inch bore
- Bearings: arbor 2 sets of roller needle bearings
- Carriage rollers 6 sets of ball bearings

Dado capacity: with 6-in. dado saw

- Width, maximum 1¼ inches
- Depth, maximum 2 inches
- Distance in front of blade (at miter gauge) . . . 15 in.
- Arbor speed recommended . . . (approx.) 4200 R.P.M.
- Motor recommended, min. ¾ H.P., 3450 R.P.M.
- Machine pulley (included) 2½-inch
- Motor pulley (included) 3 in.
- Switch (included) 2 H.P. capacity
- Carriage travel, maximum 15½ inches
- Miter cut, maximum 3¼x15 inches
- Miter graduations L, H 1° in 180° radius
- Miter graduations R, H 1° in 180° radius
- Table height 33 inches
- Over-all dimensions: Height (including handle) 40 inches; length 42½ inches; width 27 inches.

99 AM 2262—Without motor. Shipping weight 175 pounds \$93.50



Perfect-fitting straight and compound miter cuts quickly made right on the job.



Full 2 3/8-in. depth of cut permits you to cut several pieces at once; speeds up the job.



It's easy to cut large plywood panels; to notch and cut rafters, siding and flooring.



Will cut concrete, tile, granite, metals, etc., when equipped with a special cut-off wheel.

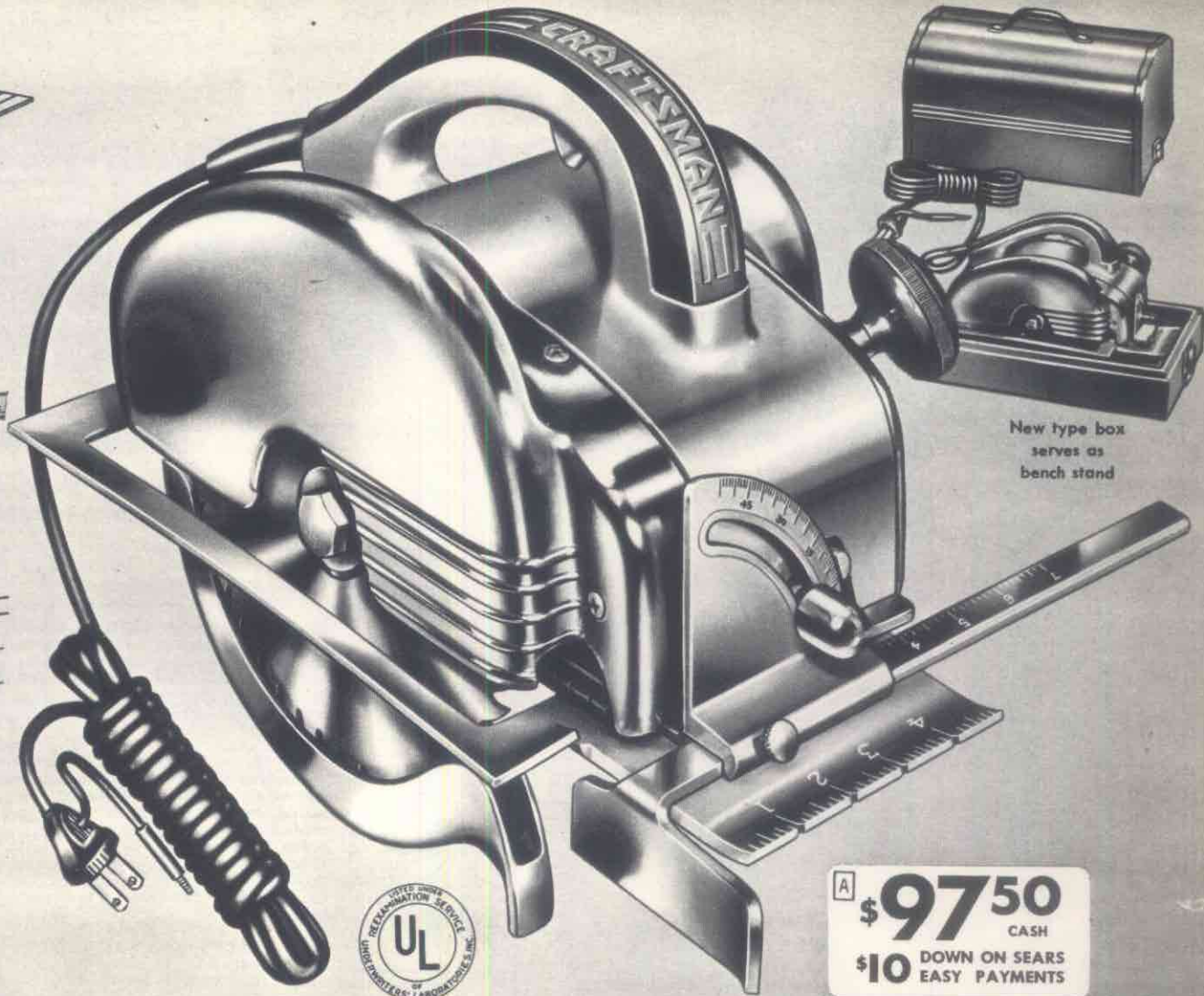

New type box serves as bench stand



\$97⁵⁰ CASH
\$10 DOWN ON SEARS EASY PAYMENTS

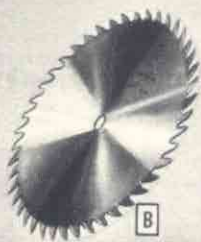

Extra Blade

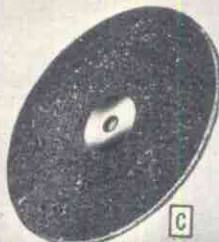

Cut-off Wheel



Extension Cord



Extra Lubricant

CRAFTSMAN 8-inch Electric Hand Saw

Improved! Now better than ever! Cuts 10 times faster than by hand!

A Now . . . even better than the tremendously popular model we sold before. Extra heavy duty. Super powered. Precision built. We believe there is no finer saw of this type made.

Here are a few of its improvements: (1) New larger base projects beyond right side for better support. (2) Improved one-piece ripping guide for greater accuracy. (3) Front edge of base plate now graduated in 1/8 in. and notched every inch, making possible the use of various guide lines. (4) Improved tilt design keeps blade in line with saw guide edge at both 45 and 90° angles. (5) Improved motor ventilation. (6) Now approved by Underwriters' Laboratories, Inc.

Efficient close-coupled design, with motor and handle close to blade for perfect balance and better gear arrangement. Blade on right side for safety and better visibility. Strong, die-cast aluminum alloy frame. Actual weight of saw is only 19 pounds. Base is adjustable for depth of cut of 0 to 2 3/8 inches.

SKF precision ball bearings throughout; double sealed. Helical-cut alloy steel gears; one Zerk fitting lubricates all gears. Telescoping guard rotates on needle bearings. Built-in saw-dust blower. Enclosed trigger switch. Knob handle on left side for two-handed operation. Heavy duty universal G.E. motor rated at 1-H.P. will develop 1 1/2 H.P. New-type steel carrying case is very handy; base acts as bench stand for saw; has compartment for extra blades, wrenches, etc.

With 8-inch combination blade, 10-ft. 3-wire rubber covered cord, unbreakable plug, tube of lubricant, wrench and carrying case.

SPECIFICATIONS:

- Depth of cut, maximum: vertical position 2 3/8 in.
- 45° position 2 inches
- Blade (included) diameter 8 inches
- bore 1/2 inch
- type combination

- Free blade speed 5300 R.P.M.
- Blade adjustment: for depth of cut. 0 to 2 3/8 in. for angle of cut . . . 45 to 90°
- Motor . . . General Electric, universal; 110-120 volt 25 to 60-cycle A.C. or D.C.
- Switch . . . Non-locking trigger type, enclosed
- Over-all dimensions: Height (with handle) 11 in.; length 15 1/2 in.; width 10 in.

99 A 02560—Complete. Shpg. wt. 38 lbs. \$97.50

B 9 A 4940—Extra 8-inch Combination Blade. 1/2-inch bore. Shipping weight 1 lb. \$2.19

C 9 A 6455—Cut-off Wheel. For concrete, tile, metal, etc. 8-in. diameter; 3/8-in. thick. Specify 1/2-inch bore. Shipping wt. 8 oz. \$1.39

D 34 A 5884—Heavy duty 25-ft. 10-gauge 2-wire Extension Cord. Approved by Underwriters' Labs. Inc. Rubber cap and cord connector. Shpg. wt. 5 lbs. \$4.49

E 9 A 2563—Extra 4-oz. Tube of Lubricant for above saw. Shpg. wt. 6 oz. 75c

CRAFTSMAN
REG. U.S. PAT. OFF.

Heavy-duty Swing Saw

Without motor **\$105.00** CASH
\$10.50 DOWN
\$141.95 With 3/4-H.P. motor

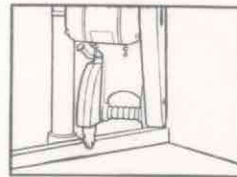

Blade of heavy-duty swing saw is pulled through lumber; this method is much faster and easier than pushing lumber through the blade

Specially designed to give YOU everything you need and want in a swing saw!

- Portable . . . Swivels 0° to 90° either to right or left
- Fast, free and easy operation . . . 3-inch depth of cut with a 10-inch blade
- Sturdy cast iron base, elevating arm, and heavy ground steel column
- Swing arm automatically returns blade to retracted position after operator releases handle

Now you can do those dadoing, ripping, mitering and cut-off jobs in record time! The CRAFTSMAN Swing Saw does the job so quickly, so easily, so accurately. No wasted motion! Just pull saw through lumber. Spring helps blade back to retracted position ready for next cut. It's the ideal tool for production use in lumber yards, shipping rooms, millwork plants and other industrial plants.

Built for heavy-duty production work. Base and elevating arm of cast iron with heavy 3-inch ground steel column make main frame rigid and sturdy. Elevating screw raises and lowers elevating arm using free-operating elevating hand wheel. Swivel permits miter or bevel cuts that are accurate because protractor indicates angle of cut to 1 degree. Swivels 0 to 90 degrees either to the left or right. Pin locks swing arm in vertical position for ripping and dado work. Another pin locks at 0, 45 or 90 degrees for miter cuts. Saw arbor is ball bearing mounted and grease packed.

Depth of cut 3 inches when using 10-inch diameter blade. 12-inch diameter circular saw blades may be used with 1-H.P. motor. Dado capacity is 1 inch.

Extra safety. Adjustable and removable guard is provided to keep blade covered. Clamp keeps it in desired position. Easily removable belt guard . . . large enough to cover 2 V-belts. Saw can be partially disassembled quickly for ease in transporting. Equipped with 10-inch combination saw blade, 3/4-inch bore (12-inch blade can also be used with 1-H.P. motor); 3-inch diameter, 3/4-inch bore arbor pulley, and motor pulleys, and 3/8x38-inch V-belt. Over-all dimensions: 40 3/4 inches high, 21 1/2 inches deep, 24 inches wide.

- 99 AM 2439—Without motor. Shpg. wt. 151 lbs. **\$105.00**
- 99 AM 2440—With 3/4-H.P. 3450 R.P.M. capacitor motor for 110-120 volt, 60-cycle, A.C. Shpg. wt. 195 lbs. **\$141.95**
- 99 AM 2443—As above, but with 1-H.P. 3450 R.P.M. 115 or 230 volt 60-cycle A.C. motor. Shpg. wt. 204 lbs. **\$150.95**

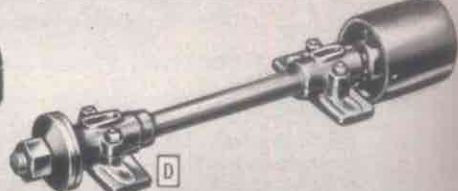
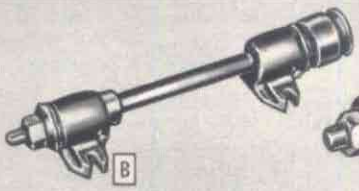
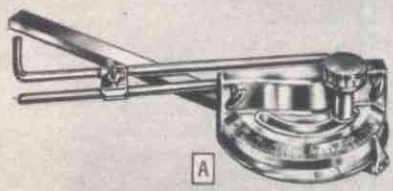
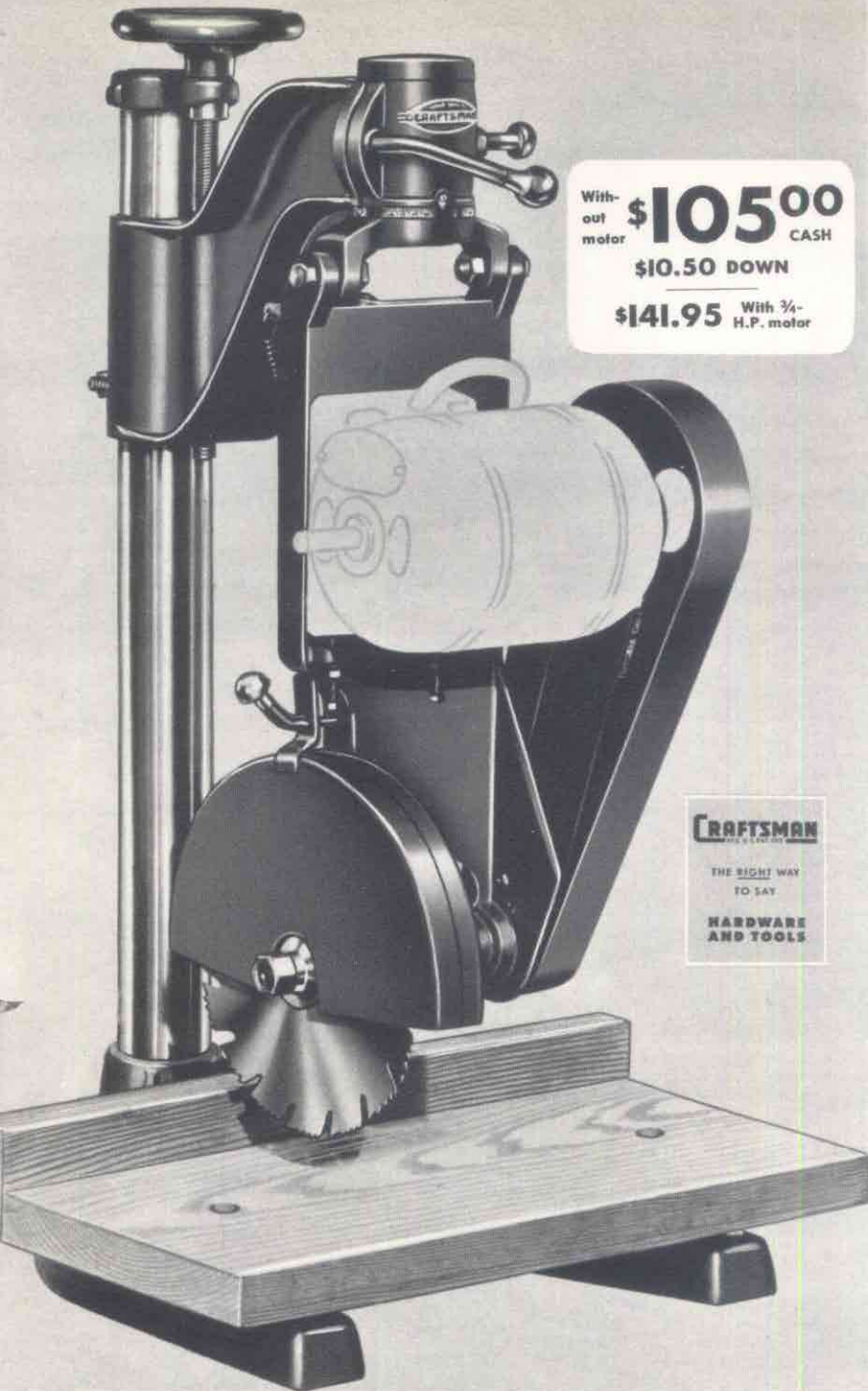

CRAFTSMAN Miter Gauge . . . Saw Mandrels

A CRAFTSMAN Miter Gauge. Scaled from 30 to 90 degrees left and right. 3/4x3/4x15 1/16-inch bar fits in miter groove in table top. Fitted with adjustable stop rods for repetitive cuts. Chromium-plated knobs; other parts have rust-resisting cadmium-plated finish. Shipping weight 4 pounds. 9 A 2257. \$4.50

B CRAFTSMAN Bronze-bearing Mandrels. Size 00. 2-inch double V-pulley for flat belt, single or multiple V-belt drive. Steel shaft; stamped steel flanges. Set collar takes up end play. Oil plugs. 14 1/16 inches long. 9 A 4946—Please state size Size 00. 3/8-in. shaft; turned to 1/2 in. at ends. Shpg. wt. 5 lbs. 5 oz. \$3.75 Size 0. 3/4-in. shaft turned to 3/8 in. at ends. Shpg. wt. 6 lbs. \$3.90

C CRAFTSMAN Ball-bearing Mandrels. Stream-lined cast iron housing. Improved, compact design. Oversize precision ball bearings grease sealed against dirt. 9 A 4948—Size 00. 3/8-inch shaft turned down to 1/2 inch at ends. Length 9 1/2 inch. Shipping weight 3 lbs. 8 oz. \$5.20 9 A 4949—Size 0. 3/4-in. straight shaft with 3/8-in. ends. Length 11 1/2 in. Shpg. wt. 4 lbs \$5.75

D Heavy Duty Saw Mandrels. Precision built. High speed babbitted bearings. Machined steel collars. Cold rolled steel shaft. Set collar. With bolts. State size wanted. \$2.90 Size 00

Size	Pulley diameter and face	Shaft Size inches	Shaft Size at end inches	Shpg. wt.	99 A 04947 Left hand threads	99 A 04932 Right hand threads
00	2 x3 in.	16 x 3/8	1 1/2	7 lbs.	\$2.90	\$2.90
0	2 x3 in.	16 1/2 x 3/8	1 1/2	15 lbs.	4.20	4.20
1	2 1/2 x 3 1/2 in.	16 3/4 x 1 1/8	1 1/2	20 lbs.	5.20	5.20
2	3 x4 in.	19 x 1 1/8	1 3/8	24 lbs.	6.30	6.30
3	3 1/2 x 4 1/2 in.	21 1/2 x 1 3/8	1 3/8	30 lbs.	7.40	7.40
6	5 x6 in.	28 1/2 x 1 7/8	1 3/8	40 lbs.	12.20	12.20
7	5 1/2 x 6 1/2 in.	30 1/2 x 1 7/8	1 3/8	48 lbs.	13.75	13.75
8	6 x7 in.	32 1/2 x 1 7/8	1 3/8	60 lbs.	15.30	15.30



Circular Saw Prices Cut up to 41%

Crosscut and Rip Saws

A B CRAFTSMAN. Professional quality. Made to stand up under day-after-day production work in factories and shops. Made of special "Super-Tuff" steel, precision heat treated. Hammered to correct tension. Deep gullets to clear out sawdust. Expertly set and filed.

State center hole size and diameter wanted.

CRAFTSMAN						(A)	(B)
Diam. In.	Gauge	Center Hole, In.	R.P.M.	Shpg. wt.	9 A 4925 Crosscut	9 A 4926 Rip	
6	18	3/8 or 1/2	6830	8 oz.	\$1.69	\$1.69	
7	18	1/2 or 5/8	6500	13 oz.	1.89	1.89	
8	18	1/2 or 5/8	5700	1 lb.	1.95	1.95	
10	16	5/8 or 3/4	4570	1 lb. 12 oz.	2.89	2.89	
12	15	3/4 or 1	3810	2 lbs. 11 oz.	3.98	3.98	

DUNLAP. (Not illustrated.) Made of fine quality tough high carbon steel, hardened and tempered. Hammered to correct tension. Set and filed.

State center hole size and diameter wanted.

DUNLAP						9 A 4911	9 A 4913
Diam. In.	Gauge	Center Hole, In.	R.P.M.	Shpg. wt.	Crosscut	Rip	
7	17	1/2 or 5/8	4750	13 oz.	\$1.59	\$1.59	
8	17	1/2 or 5/8	4500	1 lb.	1.69	1.69	
10	16	5/8 or 3/4	3600	1 lb. 12 oz.	2.39	2.39	

Flat-ground Combination Saws

C CRAFTSMAN. Special "Super-Tuff" steel accurately heat treated and hardened . . . far superior to ordinary high carbon steel. Hammered for proper tension. Expertly set and filed.

State center hole size and diameter wanted.

Diam. In.	Gauge	Center Hole, In.	R.P.M.	Shpg. wt.	9A 4937
6	18	3/8 or 1/2	6830	8 oz.	\$1.69
7	18	1/2 or 5/8	6500	13 oz.	1.89
8	18	1/2 or 5/8	5700	1 lb.	1.95
10	16	5/8 or 3/4	4570	1 lb. 12 oz.	2.89
12	15	3/4 or 1	3810	2 lbs. 9 oz.	3.98

DUNLAP. (Not illustrated.) Good general purpose saw. Tough, high carbon steel; hardened and tempered. Hammered. Set and filed.

State center hole size and diameter wanted.

Diam. In.	Gauge	Center Hole, In.	R.P.M.	Shpg. wt.	9 A 4915
7	17	1/2 or 5/8	4750	13 oz.	\$1.59
8	17	1/2 or 5/8	4500	1 lb.	1.69
10	16	5/8 or 3/4	3600	1 lb. 12 oz.	2.39

9 A 4935—7-in. Combination Blade for our former model Electric Hand Saw 2186 which has diamond shaped arbor. Shpg. wt. 12 oz. (Not shown) \$2.19

Hollow-ground Saws

D CRAFTSMAN Combination type. Taper grinding makes this the best saw for all-around work. Runs with less set. Makes the smoothest cut of any circular saw . . . smooth enough to glue without sanding. Specially filed for ripping, cross-cutting or mitering. Special "Super-Tuff" steel, heat treated for toughness . . . far superior to ordinary high carbon steel . . . stays sharp much longer. 3-gauge taper grinding provides ample clearance for free, easy cutting. Hammered for proper tension. Ideal for fine woodworking.

9 A 4939—State center hole size and diameter of saw wanted when ordering.

Diam. In.	Gauge Taper	R.P.M.	Center Hole, In.	Shpg. wt. lbs. oz.	Each
6	16 to 19	6830	1/2 or 5/8	8	\$2.49
7	15 to 18	6500	1/2 or 5/8	12	2.98
8	15 to 18	5700	1/2 or 5/8	1	3.69
10	14 to 17	4570	5/8 or 3/4	1.10	6.75
12	13 to 16	3810	3/4 or 1	2.9	9.25

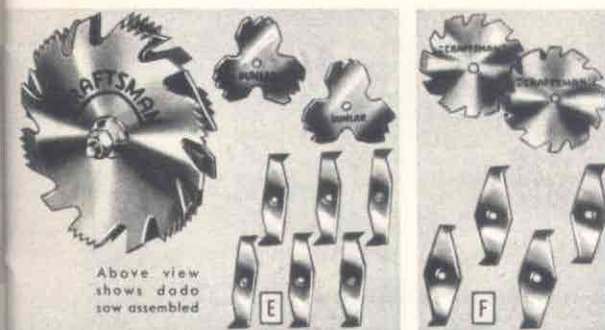

Above view shows dado saw assembled

Dado Sets

E DUNLAP 5 1/4-inch Dado Set. Tempered high carbon steel. Includes: two 3/32-inch thick outside saws, six 1/16-inch inside chippers. **\$495**
 9 A 4888—With 1/2-inch hole. Shpg. wt. 1 lb. 10 oz. Set \$4.95
 9 A 4889—With 5/8 inch hole. Shpg. wt. 1 lb. 10 oz. Set 4.95
 9 A 4884—Outside saw only. Specify 1/2 or 5/8 inch hole. Shipping weight 9 ounces. Each \$1.29
 9 A 4881—Inside Chipper only. Specify 1/2 or 5/8-inch hole. Shipping weight 3 ounces. Each 45c

F CRAFTSMAN 6-inch Dado Set. Precision ground perfectly matched chippers. Tempered steel Set includes two 3/8-inch thick outside saws, one 1/2-inch chipper, two 1/8-inch chippers, one 1/16-inch chipper. Shipping weight 3 pounds 8 ounces.
 9 A 4874—With 1/2-inch center hole. Set \$9.95
 9 A 4875—With 5/8-inch center hole. Set 9.95

Separate Dado Saw Parts. Specify 1/2 or 5/8-inch hole.
 9 A 4876—Outside Saw. Shipping weight 8 oz. Each \$3.75
 9 A 4877—1/16-inch Chipper. Shpg. wt. 3 oz. Each 55c
 9 A 4878—1/8-inch Chipper. Shpg. wt. 3 oz. Each 1.00
 9 A 4879—1/2-inch Chipper. Shpg. wt. 3 oz. Each 1.25

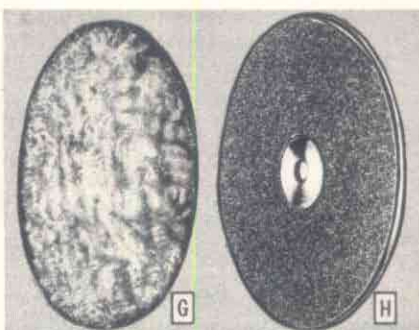

Lambswool Polishing Bonnet

G Fits over sanding plates. Polishes wax surfaces to a high finish. Shipping weight 8 oz.
 9 A 2539—Diameter 9 inches. Fits over 8-inch sanding plate. 1 1/2-inch pile. Each \$1.40

Lambswool Polishing Discs. Fits on 1/2-inch spindle. Diameter 8 inches. Has 1 1/4-inch pile of genuine lambswool. Polishes waxed surfaces to high lustre.
 9 A 2529—Shpg. wt. each 8 oz. Each \$1.20

Sanding Wheel

H 8-in. diameter. 1/2 or 3/4-in. bore. Steel. Fits any 8-in. or larger bench saw, having 1/2 or 3/4-in. arbor. Has one medium and one coarse abrasive disc for wood, attached. State bore size.
 9 A 2272—Shipping weight 4 lbs. \$2.50

Replacement Sanding Discs, for 9 A 2272 above. 8-in. diameter. 2-in. center hole fits over any arbor. Package of six assorted: 2 each of fine, medium and coarse grit.
 9 A 2273—Shipping weight 10 oz. \$7c

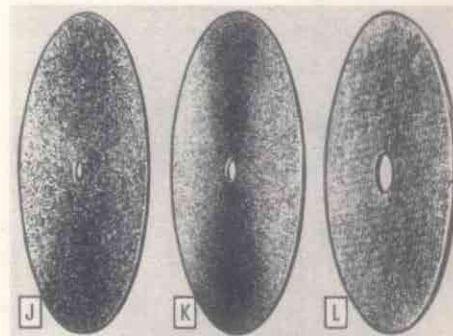

Cut-off Wheels

J Rubber Bonded Aluminum Oxide. 8-in. diam. by 3/32 in. thick For 1/2, 5/8 or 3/4 in. shaft.
 9 A 6470—State shaft. Shpg. wt. 1 lb. 98c

K Resinoid-Bonded. 8 in. diam., 3/32 in. thick. For 1/2, 5/8 or 3/4 in. shaft. State shaft diam.
 9 A 6448—For steel sheets or tubing, etc. (aluminum oxide). Shpg. wt. 1 lb. Each \$1.19
 9 A 6449—For tile, porcelain, etc. (silicon carbide). Shpg. wt. 1 lb. Each 1.39
 9 A 6455—For cast iron, brick, concrete, etc. (silicon carbide). Shpg. wt. 1 lb. Each 1.39

Bayflex Abrasive Wheels

L Safest all purpose grinding wheel made. It's cotton felted, aluminum oxide impregnated and resinoid bonded. Use to replace hack saw, file, sharpening wheel or circular saw. 1-in. hole. Bushings furnished for smaller shafts.
 9 A 6428—State diameter, grit and hole size

Diam.	Thickness	R.P.M.	Grit	Shpg. wt.	Each
6 in.	1/16 in.	10,000	120	8 oz.	\$1.43
6 in.	1/32 in.	10,000	80	12 oz.	1.75
6 in.	3/8 in.	10,000	24	1 lb.	2.10
7 in.	1/16 in.	8,500	120	12 oz.	1.85
7 in.	1/32 in.	8,500	80	1 lb.	2.25
7 in.	3/8 in.	8,500	24	1 lb. 8 oz.	2.69
8 in.	1/16 in.	7,500	120	1 lb.	2.29
8 in.	1/32 in.	7,500	80	1 lb. 4 oz.	2.85
8 in.	3/8 in.	7,500	24	1 lb. 8 oz.	3.39
10 in.	1/16 in.	6,000	24	2 lbs.	5.25
10 in.	3/8 in.	6,000	24	3 lbs.	8.45

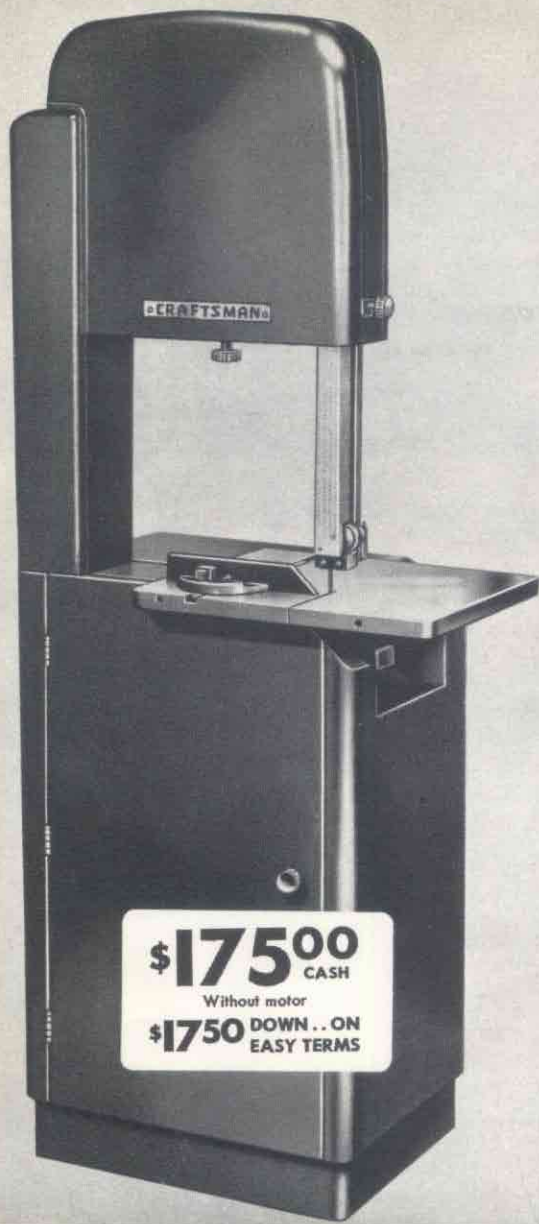

\$175⁰⁰
CASH
Without motor
\$1750 DOWN.. ON
EASY TERMS

CRAFTSMAN "100" REG. U.S. PAT. OFF. 18-in. Band Saw

Extra-large capacity CRAFTSMAN Band Saw. Now you can cut to the center of 36-inch circle in lumber up to 12½ inches thick. It's the finest 18-inch band saw we've ever sold... and at such a comparatively-low price.

Streamlined, full enclosed design. All operating parts except the actual cutting edge of blade are covered by heavy-gauge steel casing. Has heavy-duty welded all-steel frame. Two-wheel (rubber-tired) cast iron construction. Lower wheel is the driver and is connected by belt to motor.

Extra-large table, 20¼ x 17¾ inches, of smooth ground cast iron tilts down and locks at any angle from 0 degrees to 45 degrees. Saw guides above and below the table guide blade straight and accurately... have ball bearing thrust wheels... give you accurate, true cutting.

SPECIFICATIONS:

- Depth of Throat.....18 inches
- Thickness of cut, maximum.....12½ inches
- Table size.....20¼x17¾ inches
- Length of Blade (one ¼-in. width included).....11 feet
- Width of Blade.....¾ to 1 inch
- Bearings.....Six sets of grease sealed precision ball
- Size of each wheel.....18 inches
- Machine pulley (included).....7-inch Single groove V
- Motor pulley (not included).....3-inch Single groove V
- Motor recommended, minimum.....1 H.P. 1750 R.P.M.
- Over-all dimensions: Height 75 inches; width 22¼ inches; depth 31 inches

99 AM 2377F—Without motor. Shipped from factory in Cincinnati, Ohio from where you pay shipping charges. Shipping weight 420 pounds.....**\$175.00**

CRAFTSMAN 18-inch Band Saw 99 AM 2377F above is not carried in stock or on display in many of our stores; however, shipment from factory can be made immediately.



\$44⁵⁰
CASH
Without motor
\$450 DOWN.. ON
EASY TERMS

CRAFTSMAN 3-wheel Band Saw REG. U.S. PAT. OFF.

ACTUAL TESTS PROVE: blade is super-strong... cut over two miles of 2-in. yellow pine with no sign of blade failure. **Machine is sturdiest ever**... ran continuously and perfectly for more than 500 hours while cutting over 25 miles of 1-in. yellow pine.

The brand new CRAFTSMAN "100" 3-wheel Band Saw is much more compact than conventional saws of same capacity, yet it has the same strength, accuracy and durability usually found only in larger saws. *It's the finest we've ever sold! More accurate! More compact! Much stronger!*

New sleek streamlined housing design gives an indication of what to expect in the way of smooth operation, hairline accuracy, exceptional safety, and faithful service. All operating parts except cutting edge of blade are completely covered. If blade ever breaks, it can't fly out. Even the mounting brackets are concealed. Table tilts from 0° to 45°.

Cuts to center of 24-inch circle. Makes curved or irregular cuts in wood up to 4 inches thick. Built-in blade tension device. Double row ball bearings are mounted as an integral part of the drive shaft to avoid any chance of misalignment. Double row

of needle roller bearings on other two idler wheels. **Rubber tires are trued by grinding** and wheels are die cast and machined to close limits. Concentricity is assured! Blade alignment is more positive! You get a minimum of vibration!

SPECIFICATIONS:

- Depth of Throat.....12 inches
- Thickness of cut, maximum.....4 inches
- Table size.....12x12 inches
- Length of Blade (one ¼-inch width incl.) 62 inches
- Width of Blade.....¾ to 1 inch
- Bearings.....2 sets double row precision ball
- Machine pulley (included).....4-inch
- Motor pulley (not included).....3-inch
- Motor recommended, minimum.....¾-H.P. 1750 R.P.M.

• Over-all dimensions.....Height 20¼ inches; width 12 inches; depth 28¼ inches

99 AM 2430—Shipping weight 73 pounds.....**\$44.50**

99 AM 2431—As above but with ¾-H.P. 1750 R.P.M. ball-bearing motor (110-120 volt 60-cycle A.C.). 3-inch motor pulley, and ½x48-inch V-belt. Shipping weight 98 pounds.....**\$62.50**

Band Saw Blades

CRAFTSMAN. Made of finest quality saw steel. Every blade is properly set and filed for recommended use. Shipping weight each blade 7 ounces. **When ordering please state width wanted.**

- 9 A 2660—For wood. 56¼ in. long; ¼ or ⅜ in. wide..... **95c**
- 9 A 2336—For wood. Skip tooth type. 58 in. long; ⅜, ½, or ⅝ in. wide..... **95c**
- 9 A 2664—For wood. Skip tooth type. 62 in. long; ⅜, ½ or ⅝ in. wide..... **\$1.20**
- 9 A 2665—For wood. 63 in. long; ¼, ⅜, or ½ in. wide..... **95c**
- 9 A 2657—For wood. 78 in. long; ¼, ⅜, ½ or ⅝ in. wide..... **95c**
- 9 A 2623—For wood. 80 in. long; ¼, ⅜, ½ or ⅝ in. wide..... **95c**
- 9 A 2668—For brass and non-ferrous metals. 78 in. long; ¼ in. wide..... **95c**
- 9 A 2624—For brass and non-ferrous metals. 80 in. long; ¼ in. wide..... **95c**
- 9 A 2625—For steel. 80 in. long; ¼ in. wide..... **\$1.45**
- 9 A 2715—For wood. 132 in. long. ¼, ⅜, or ½ in. wide..... **1.95**

Special Length Band Saw Blades

9 A 2669F—**CRAFTSMAN.** Not brazed. Blades brazed for 35c each, in addition to prices below. **State length and width wanted and if you want blades brazed.** Shipped from factory in Chicago.

Width	Shipping weight	Per foot
¼ inch.....	1 ounce.....	13c
⅜ inch.....	1 ounce.....	13c
½ inch.....	1 ounce.....	13c
⅝ inch.....	1 ounce.....	14c
¾ inch.....	1 ounce.....	17c
1 inch.....	2 ounces.....	19c
1¼ inch.....	2 ounces.....	21c
1½ inches.....	3 ounces.....	22c
1¾ inches.....	3 ounces.....	29c
2 inches.....	3 ounces.....	35c



AS LOW AS
95c

Many types
Choice of blades for use with wood, brass, non-ferrous metals, steel

Many sizes
Range from 56¼ to 132 inches long; ¼ to ¾ inch wide

Special lengths
For cutting wood... made to order ¼ to 1½ inches wide

CRAFTSMAN

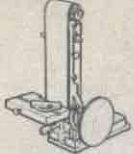

Can be used in vertical position



\$31.50 CASH
Without motor
\$3.50 DOWN ON TERMS

CRAFTSMAN Belt Sander

One of the most versatile and useful CRAFTSMAN Power Tools. It takes the hard tedious work out of sanding. Do curved and irregular work with the end drums and all types of flat work with 6-inch wide flat belt. Stop bars can be removed to enable you to sand extra long work on the belt.

Position of belt sander easily adjusted. Can be used in vertical position (as shown in small view at top of page) or any angle 0° to 90°.

Quick-change belt release. Rapid change from belt of one grit to another. Lever releases belt tension. Rubber-covered belt rollers act as sanding drums.

Rugged construction. Self-lubricating porous bronze bearings insure long life and smooth operation; oil well around each. Cast iron frame; gray enameled.

SPECIFICATIONS:

- Width of belt..... 6 inches; Circumference of belt..... 48 5/16 inches
- Table size—sanding belt table..... 6 1/2 x 17 9/16 inches
- Bearings..... porous bronze
- Drum diameter..... 3 inches
- Machine pulley (included)..... 3 inch
- Motor pulley (not included)..... 2 1/2 inch
- Motor recommended, minimum..... 1/2 H.P. 1750 R.P.M.
- Mounting dimensions..... 7 x 15 1/16 inches
- Over-all dimensions: Height 11 1/4 in.; width 20 3/4 in.; length 28 3/4 in.

Comes with adjustable stop guard, sanding belt and 3-inch machine pulley.

CRAFTSMAN Belt Sander without motor, motor pulley or V-belt.

99 AM 2728—Shipping weight 53 pounds..... **\$31.50**

CRAFTSMAN Sanding Table. For Belt Sander 99 AM 2728. 6 1/2 x 12 inches. Can be tilted to any angle up to 45°. Use on left side of sander or at the end. Miter gauge included; fits slot in table. Ground cast iron; gray enameled.

9 A 2729—Shipping weight 9 pounds 12 ounces..... **\$8.75**

Disc Sander. For Belt Sander 99 AM 2728. Use for end grain and small work.

9 A 2730—9-inch diameter. Shipping weight 2 lbs..... **\$3.25**

\$64.50 CASH
Without motor
\$6.50 DOWN ON TERMS



CRAFTSMAN Shaper

Built for high speed light duty production work. Cuts smoothly and rapidly at all possible angles to the grain of the wood.

Extra-large heavy-duty table. 21x15 inches. Bevel gears and screw mechanism move table up and down. Fence is adjustable with one side movable in or out for planing operations. Scale shows depth of cut.

Fixed spindle construction. Spindle and bearing assembly mounted in frame. Cutters prevented from coming loose by keyway in shaft with keyed washer. Protective belt guard.

Built-in motor mount; spring hold-downs included.

SPECIFICATIONS:

- Cutter height..... 1 1/2 inches
- Cutter bore..... 1/2 inch
- Spindle bearings..... 2 sets precision ball
- Table size..... 21x15 inches
- Table height (variable)..... 10 3/4 to 12 3/4 inches
- Miter gauge slot..... 3/4 in. wide; 1/4 in. deep
- Right fence face adjustable..... up to 1/2 inch
- Spindle..... 1/2-in.; 1/2 x 24 thread
- Spindle speed, recommended..... 8270 R.P.M.
- Machine pulley (included)..... 1 1/2 inches
- Motor pulley (included)..... 4-inch diam.; 1/2-in. bore
- V-belt (included)..... 1/2 in. x 31 in.
- Motor recommended (min.)..... 1/2 H.P., 3450 R.P.M.
- Mounting dimensions..... 10 3/4 x 9 1/2 inches
- Over-all dimensions: height 18 1/4 in.; width 16 in.; depth (without motor) 27 in.

99 AM 2381—Without motor. Shpg. wt. 106 lbs..... **\$64.50**

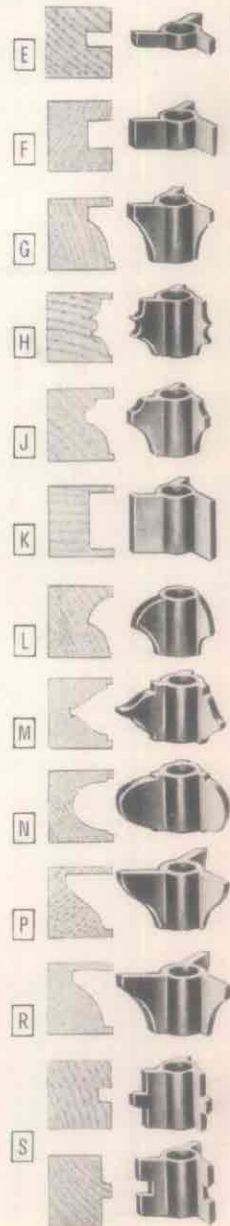

Shaper Cutters

These high-speed shaper cutters permit you to form almost any kind of contour quickly and accurately. Made of finest quality special alloy tool steel; carefully hardened and ground; precision machined. Cutters have 1/2-inch bore.

7/8-inch radius cutters. Shpg. wt. ea. 6 oz.

(E) 9 A 2319—1/4 inch high.....	\$1.35
(F) 9 A 2321—1/2 inch high.....	1.60
(G) 9 A 2323—1 inch high.....	1.90
(H) 9 A 2327—1 inch high.....	1.90
(J) 9 A 2329—1 inch high.....	1.90
(K) 9 A 2333—1 inch high.....	1.85
(L) 9 A 2335—1 inch high.....	1.90

Your Choice \$2.75. Large Size Cutters. Shpg. wt. ea. 8 oz.

(M) 9 A 2345—1 inch high. 1 1/4-inch radius.....	\$2.75
(N) 9 A 2346—1 inch high. 1 1/4-inch radius.....	2.75
(P) 9 A 2347—1 inch high. 1 1/4-inch radius.....	2.75
(R) 9 A 2348—1 inch high. 1 1/4-inch radius.....	2.75

Matched Set of Tongue and Groove Cutters

[S] A complete matched set of tongue and groove cutters to be used in connection with your drill press or shaper. Precision ground and matched for accurate fit. 1/2-inch bore; 1 inch high; 3/8-inch radius.

9 A 2365—Shipping weight 10 ounces..... Set **\$3.75**

Shaper Collars (not shown). Mount beneath shaper cutters to control depth of cut on curved work. Fit 1/2-inch spindle.

9 A 2367—Shipping weight 6 ounces..... Set **\$1.85**

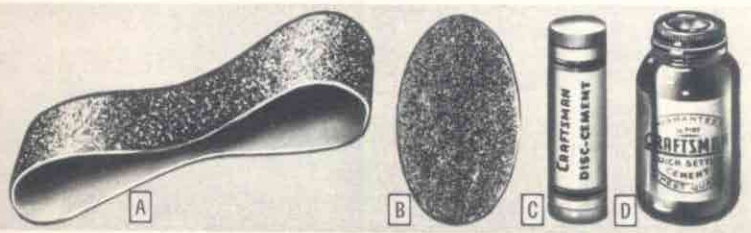

Belt and Disc Sander Accessories

- [A] **Sanding Belts.** Endless construction. Aluminum oxide on cloth. For sanding wood or metal. Choice of fine, medium or coarse grit size. *State grit wanted.*
- 9 A 2167—6x48 5/16 inches. Shpg. wt. 8 oz. **\$1.05**
- [B] **Abrasive Sanding Discs.** 9-in. diameter. Aluminum oxide on paper. For wood or metal. Six discs of same grit size in package. Choice of fine, medium or coarse grit. *Please state grit wanted.*
- 9 A 2526—Shipping wt. per pkg., 8 oz.
Package of 6 fine grit for..... **55c**
Package of 6 medium grit for..... **65c**
Package of 6 coarse grit for..... **80c**
- [C] **Disc Cement.** Holds sanding discs to metal or wood sanding plates. Non-drying. Choice of 4 3/4 or 16-oz. sticks.
- 9 A 2219—4 3/4 oz. Shipping weight 6 ounces..... **29c**
9 A 2229—16 oz. Shipping weight 18 ounces..... **62c**
- [D] **Cement.** Fastens abrasive discs to metal plates. Sets quickly, holds firm. Shipping weight 1 pound 2 ounces.
- 9 A 2535—1/2 pint..... **45c**

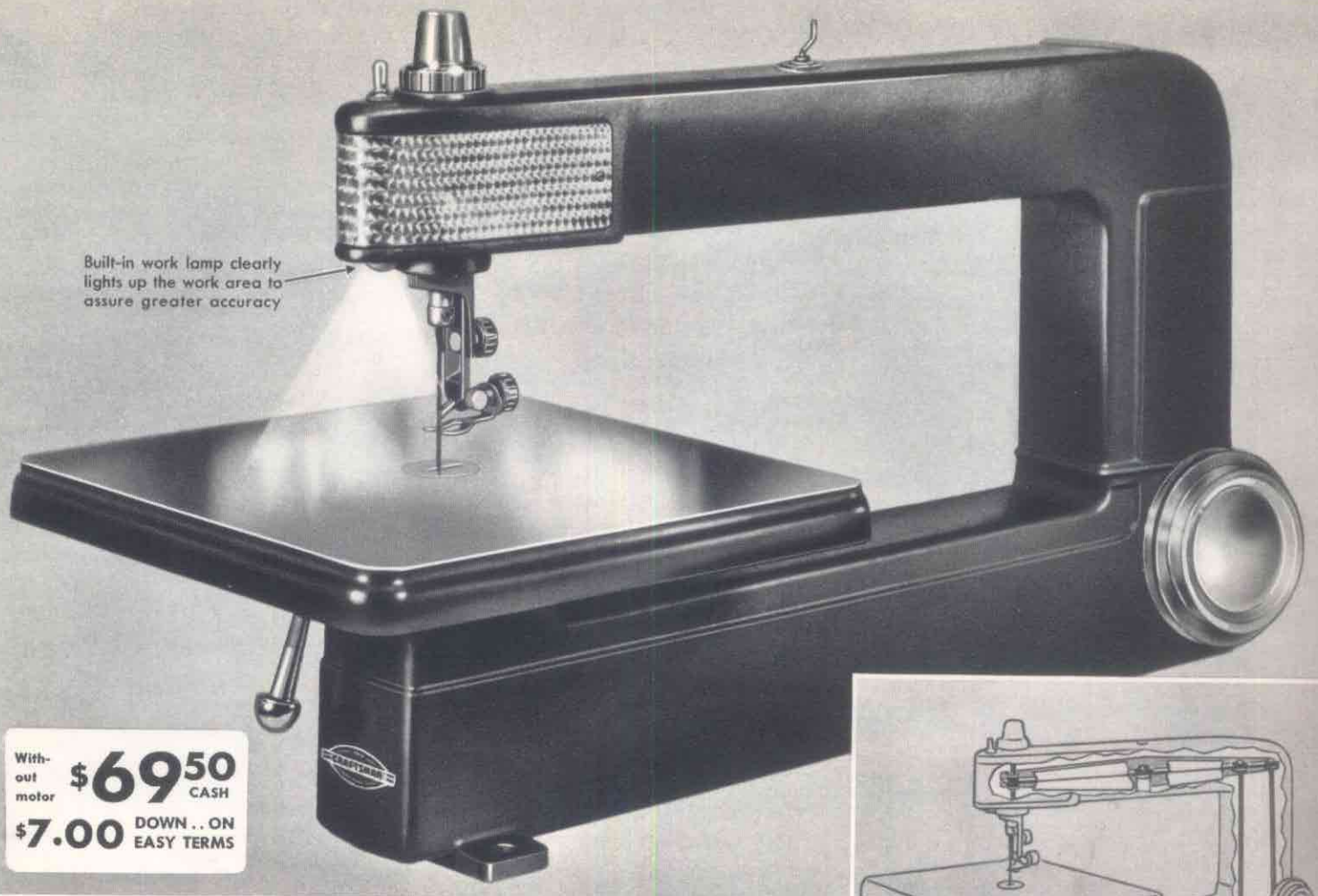

Built-in work lamp clearly lights up the work area to assure greater accuracy

Without motor **\$69.50** CASH
\$7.00 DOWN... ON EASY TERMS

CRAFTSMAN "100" Jig Saw

Ball bearing equipped . . . 24-inch capacity

- Double-row precision ball bearings on drive shaft assure smooth operation and long life.
- Lifetime lubrication . . . never needs oiling or greasing . . . no spoiled work due to oil spots.
- Cuts to center of a 48-inch circle in wood up to 2 in. thick. Also cuts metals, plastics, etc.

By far the finest jig saw ever to bear the famous CRAFTSMAN name. Amazingly smooth and quiet in operation because of the time-tested "Walking-Beam" action, the precision ball bearings, the extra heavy duty construction, and other quality features. Meets the most rigid requirements of professional craftsmen and large woodworking shops.

Extra large size table. Full 16x16 inches to give plenty of working surface; made of smooth-ground cast semi-steel. Tilts 0 to 45° on double trunnion supports; gauge shows angle of tilt. Blade chucks and table can be turned 90° for ripping long pieces.

Many super-quality features. 7½-watt work lamp built into head; lights up working area; has switch, cord and plug. Concealed sawdust blower gives a real blast of air. Entering cuts at sharp angles are possible because the new blade support guides the blade above and below the work . . . reduces blade breakage, too. Hold-down foot prevents lifting work off table on the upward stroke of blade. Hold-down is adjustable, even with table tilted. Enclosed, one-piece cast semi-steel base with rust-resisting gray enameled finish.

SPECIFICATIONS:

- Depth of throat 24 inches
- Depth of cut, maximum, in wood 2 inches
- in plastic 1½ inches
- in brass ¾ inch
- in aluminum and zinc ½ inch
- Table size 16x16 inches
- Motor recommended, min. ¼ H.P. 1750 R.P.M.
- Machine pulley (included) 5 and 6-in.
- Motor pulley (not included) 2-inch and 3-inch
- Speed 525 and 1015 R.P.M.
- Stroke 1 ½ inches
- Mounting dimensions 5 ½ x 30 ½ inches
- Over-all dimensions: Height 21 ½ inches; length 39 ¾ inches; width 16 ¾ inches

Motor can be mounted above, below or behind. One 6-inch plain end blade included. Shpg. wt. 123 lbs.
 99 AM 2344—24-inch jig saw without motor \$69.50
 99 AM 2393—24-inch jig saw with ¼ H.P. 1750 R.P.M. split phase bronze bearing 110-120 volt, 60-cycle A.C. motor, 2-in. and 3-in. motor pulley, ½x36-in. V belt. Shpg. wt. 147 lbs. \$81.50

CRAFTSMAN "40" Magnetic Jig Saw

- Cuts to center of a 22-inch circle.
- Cuts wood up to ½ inch thick.

Needs no motor . . . no belt . . . no gears . . . no oiling. Just plug it in; snap the on-off switch. Magnetic power unit in base gives 7200 smooth, short cutting strokes per minute. Produces super smooth edges that need no sanding. It's the safe, easy-to-operate hobby tool that every member of the family can use. The short stroke makes it safe even for children to use. But don't mistake it for a toy . . . it's a rugged, well made power tool. Just the thing for making hundreds of articles from wood, plastic or metal. Approved by Underwriter's Laboratories.

SPECIFICATIONS:

- Depth of throat 11 inches
- Depth of cut, maximum in wood ½ inch
- Table size 8 ½ x 8 inches
- Over-all dimensions: Height 10 ½ inches, width 8 ½ inches; length 16 ¼ inches

All metal construction; non-slip rubber feet. Comes complete with one 5-inch pin-end blade, 5 ½ ft. of connecting cord and operating instructions. Use on 110-120 volt 60-cycle A.C. only.

99 A 02632—Shipping weight 14 lbs. \$12.50
 9 A 2690—Extra blades for above jig saw. 5 inches long. Shipping wt. 1 oz. 6 for 25c

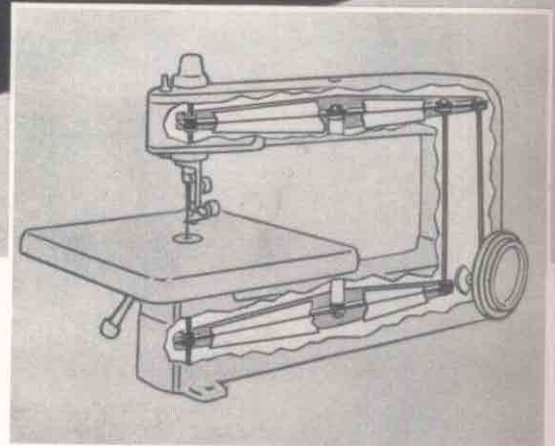

"Walking Beam" Action

The sensational "Walking Beam" action assures exceptionally smooth, quiet and accurate operation. An H-shaped stamped channel section delivers power uniformly to the blade on both the up and down strokes. Eliminates the need for a jerky return spring. This type of construction greatly reduces vibration. It also minimizes blade breakage, especially when using fine fret or jewelers' blades. The drive action operates through double-bearing guides above and below the blade.



"80" Jig Saw

18-inch throat capacity



Without motor **\$29⁵⁰** CASH
\$3.00 DOWN . . ON EASY TERMS

- Cuts to the center of a 36-inch circle.
- Handles material up to 2 inches thick.

This saw is specially designed to stand up under hard professional use . . . that's why it does such a superb job in the home shop. Cuts wood, metal, plastics, etc.

Modified Scotch-Yoke action assures smooth, quiet operation. Runs in bath of oil. Porous bronze main bearings. 12x12-inch cast semi-steel table tilts from 0 to 45 degrees on double pivots; gives large working surface. Frame is strongly made of cast semi-steel. Upper arm is removable for filing and saber sawing. Blade chucks rotate 90° for ripping pieces longer than 18 inches. No twisting of blade because shoe in chuck gives a firm grip between the blade and the clamping member. Upper and lower blade guides. Adjustable hold-down prevents work from lifting off table.

Fully enclosed coil type return spring. Built-in sawdust blower clears sawdust from working area. Uses 5 or 6-inch plain end blades (one blade included).

SPECIFICATIONS:

- Depth of throat 18 inches
- Depth of cut, maximum 2 inches
- Table size 12x12 inches
- Machine pulley (included) 4-inch
- Motor pulley (not included) 2-inch
- Motor recommended, minimum ¼ H.P. 1750 R.P.M.
- Speed 860 R.P.M.
- Sawdust blower Built into head
- Mounting dimensions 5½x22½ inches
- Over-all dimensions: Height 17½ inches; length 29 inches; width 12 inches.

99 AM 2315—18-inch Jig Saw without motor. Shipping weight 70 pounds. **\$29.50**
99 AM 2290—18-inch Jig Saw with ¼ H.P. 1750 R.P.M. split phase bronze bearing 110-120 volt 60-cycle A.C. motor. 2-inch motor pulley, ½x66-inch V-belt. Shipping weight 96 pounds. **\$42.50**

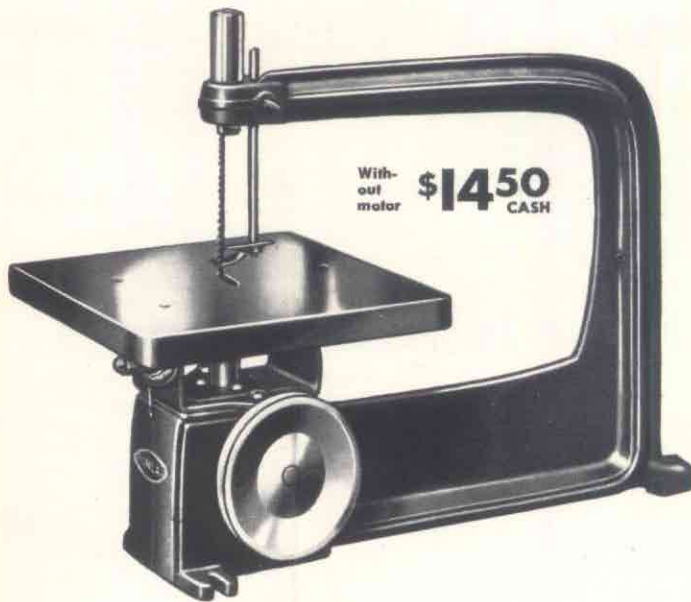

Without motor **\$14⁵⁰** CASH

DUNLAP Jig Saw

REG. U.S. PAT. OFF.

- Cuts to center of a 24-inch circle.
 - Handles work up to 1 inch thick.
- One of the smoothest operating small jig saws we know of. Ideal for use in the hobby shop or home workshop. Cuts wood, metal, plastics, etc.
- Modified Scotch Yoke action** for smooth operation. Runs in bath of oil. Fully enclosed coil type spring reduces whip for smoother, more accurate operation. Adjustable blade guide and hold-down. Built in blower clears away sawdust.
- Big 9x9-inch table of cast semi-steel; tilts any angle from 0 to 45°; rigidly supported at two points; has tilt indicator. One-piece cast semi-steel frame with rust-resisting gray finish. Uses 5-inch pin-type blade (one blade is included with saw).

SPECIFICATIONS:

- Depth of throat 12 inches
 - Depth of cut, maximum 1 inch
 - Table size 9x9 inches
 - Machine pulley (included) 4-inch
 - Motor pulley (not included) 2-inch
 - Motor recommended, minimum ¼ H.P., 1750 R.P.M.
 - Speed 860 R.P.M.
 - Mounting dimensions: 16½x4½ inches
 - Over-all dimensions: Height 14½ inches; length 17½ inches; width 9 inches. Shpg. wt. 32 lbs.
- 99 A 02179—Without motor **\$14.50**
99 AT 2184—With ¼ H.P., 1750 R.P.M. split phase sleeve bearing 110-120 volt, 60 cycle A.C. motor. 2-in. motor pulley, ½x54-in. V belt. Shipping weight 35 pounds. **\$26.00**

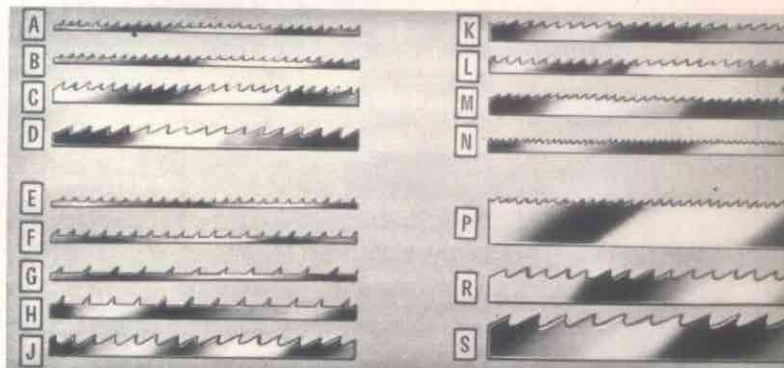

Jig, Fret and Coping Saw Blades

These high quality blades are made of special alloy "Super-Tuff" steel, heat treated and hardened for long life and fast, easy cutting action. This alloy is famous for its combination of toughness and exceptionally fine edge-holding qualities. 6 and 8½-inch plain-end blades can be snapped off to fit machines taking shorter plain-end blades. Saber-tooth blades can be used for heavy work, as well as saber work. Shipping weight 1 ounce.

25c Per package

Catalog Number	Recommended uses	Length, inches	Teeth per in.	Thick, inch	Width, inch	Blades in Pkg.	Per Pkg.
(PIN TYPE BLADES)							
(A) 9A2712	Fits hand magnetic jig saw	2¾	18	.010	.040	6	25c
(B) 9A2690	Fits magnetic jig saw	5	18	.010	.040	6	25c
(C) 9A2705	Medium, for wood	5	15	.020	.110	6	25c
(D) 9A2704	Coarse, for wood	5	10	.020	.110	6	25c
(PLAIN END BLADES—FOR MOST JIG SAWS)							
(E) 9A2693	Extra fine for delicate cuts in wood	6	18	.010	.045	8	25c
(F) 9A2695	Fine, for cuts in thin wood	6	14	.010	.070	8	25c
(G) 9A2711	Skip tooth; for plastics and soft metals	6	7	.020	.110	6	25c
(H) 9A2710	Skip tooth; for heavier duty than 9A2711	6	7	.020	.110	6	25c
(J) 9A2700	Coarse; for wood or soft metal	6	10	.020	.110	6	25c
(K) 9A2701	Fine; for wood or soft metal	6	16	.020	.110	6	25c
(L) 9A2702	Extra fine; for wood or soft metal	6	16	.014	.078	6	25c
(M) 9A2709	Fine; for sheet metals including steel	6	20	.020	.110	6	25c
(N) 9A2703	Extra fine; for same uses as 9A2709	6	32	.020	.070	6	25c
(SABER BLADES)							
(P) 9A2867	For metal cutting, similar to hack saw	6	20	.028	.250	3	25c
(R) 9A2869	For wood and soft metals	6	10	.028	.1875	3	25c
(S) 9A2866	For coarse cuts in wood	6	7	.028	.250	3	25c

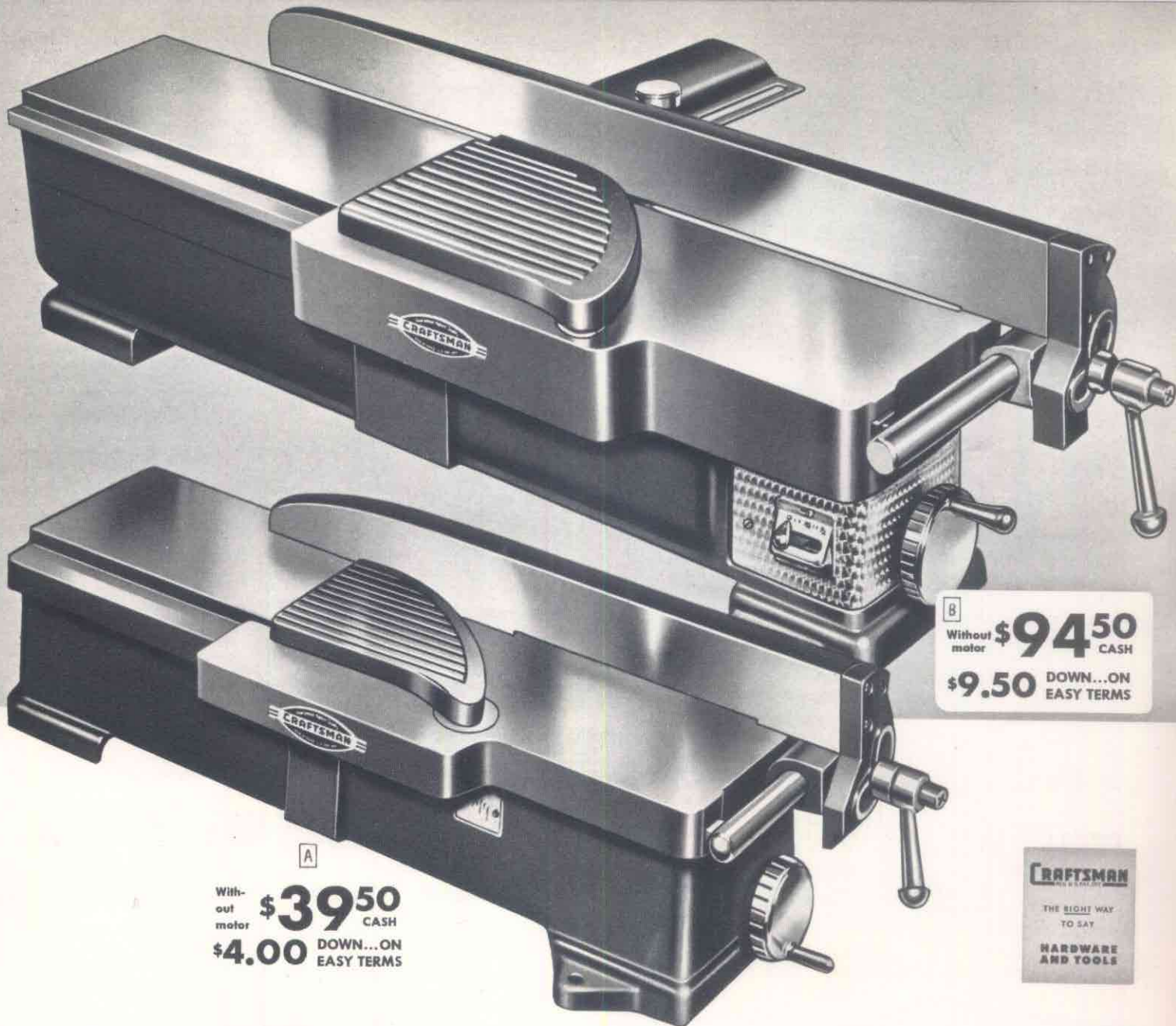

B
Without motor **\$94.50** CASH
\$9.50 DOWN...ON EASY TERMS

A
Without motor **\$39.50** CASH
\$4.00 DOWN...ON EASY TERMS



CRAFTSMAN ball-bearing type Jointer-Planers

CRAFTSMAN 4 3/8-in. Jointer-Planer

CRAFTSMAN 6-in. Jointer-Planer

A The ideal jointer-planer for small woodworking shops, school shops and home workshops. The three 4 3/8-inch high-speed steel knives in the 1/4-inch cutter head are securely locked in. Retain sharp, easy-cutting qualities.

B Heavy-duty jointer-planer gives you greater accuracy, smoother operation and greater safety. 6-inch solid steel cutter head has 3 high speed steel knives.

Front and rear table are precision ground cast iron and operate on accurately machined ways to insure perfect alignment. 19 1/4-inch fence tilts 45 degrees either way . . . locks in position. Rugged one-piece cast iron base, with three-point mounting, eliminates twist or strain, gives rigid support.

Sturdy construction. Extra-long, precision-ground, cast-iron table. Three-point suspension mounting of rear table aligns it perfectly with front table. Front table mounted on double set of widely spaced ways. One-piece base is rugged cast iron, giving rigid support. Three-point-of-contact mounting eliminates twist.

Quick-acting guard gives positive protection . . . readily removable for making rabbeting cuts. Accurate gauges for indicating depth of cut and angle of tilt with rip fence. Ball bearings sealed against dirt and lubricated for life.

Quick-acting spring-loaded guard gives complete protection. It never needs to be removed while machine is running. Guard can be removed in one motion for rabbeting cuts. Belt and pulley fully enclosed by guard for safety. 31 1/16-inch fence tilts up to 45° in either direction . . . locks in place.

- SPECIFICATIONS:**
- Width of cut 4 3/8 in.
 - Rabbet depth 3/8 in.
 - Spindle diameter 1 1/2 in.
 - Size, front table 11 3/16 x 6 5/8 in.; rear table 11 3/8 x 6 5/8 in.
 - Bearings 2 sets of shielded precision ball
 - Cutter knives 3 high-speed steel, 4 3/8 x 1 1/2 x 1/8 in.
 - Recommended speed approximately 4500 R.P.M.
 - Motor recommended minimum 1/2-H.P. 1750 R.P.M.
 - Machine pulley (included) 2 inch
 - Motor pulley (not included) 5 inch
 - Mounting dimensions 7 3/4 x 21 3/4 in.
 - Overall dimensions Height 8 in.; width 9 3/4 in.; length 29 1/16 in.
- 99 AM 2334—CRAFTSMAN Jointer-Planer without motor. Shpg. wt. 63 lbs. **\$39.50**
 99 AM 2317—CRAFTSMAN Jointer-Planer with 1/2-H.P. 1750 R.P.M. bronze bearing split phase motor for 110-120-volt 60-cycle A.C., 5-inch motor pulley, 1/2 x 40-inch V-belt. Shipping weight 90 pounds **\$52.50**

- SPECIFICATIONS:**
- Width of cut 6 1/2 in.
 - Rabbet depth 1/2 in.
 - Spindle diameter 1 3/4 in.
 - Size, front table 16 3/16 x 7 7/8 in.; rear table 17 3/8 x 7 3/8 in.
 - Bearings 2 sets of shielded precision ball
 - Cutter knives 3 high-speed steel, 6 1/2 x 1 1/2 x 1/8 in.
 - Recommended speed approximately 4500 R.P.M.
 - Motor recommended minimum 1/2-H.P. 3450 R.P.M.
 - Machine pulley (included) 2 inch
 - Motor pulley (not included) 5 inch
 - Mounting dimensions 8 5/8 x 32 1/4 in.
 - Overall dimensions Height 11 3/4 in.; width 20 in.; length 42 1/2 in.
- 99 AM 2390—CRAFTSMAN Jointer-Planer without motor. Shpg. wt. 143 lbs. **\$94.50**
 99 AM 2391—CRAFTSMAN Jointer Planer with 1/2-H.P. 3450 R.P.M. ball-bearing capacitor motor for 110-120-volt 60-cycle A.C., 2 1/2-inch motor pulley, 1/2 x 42-inch V-belt. Shipping weight 181 pounds **\$123.50**

4 3/8-inch Jointer Replacement Knives. High-speed steel blades; ground to a keen edge. Set of three for above jointer-planers or for Nos. 2287 and 2290. 9 A 2291—Shipping weight 7 ounces. Set **\$3.25**

6 1/2-inch Jointer Replacement Knives. Made of high-speed steel; expertly ground. Set of three for above jointer and for thickness planer No. 2370. 9 A 2293—Shipping weight 10 ounces. **\$3.85**

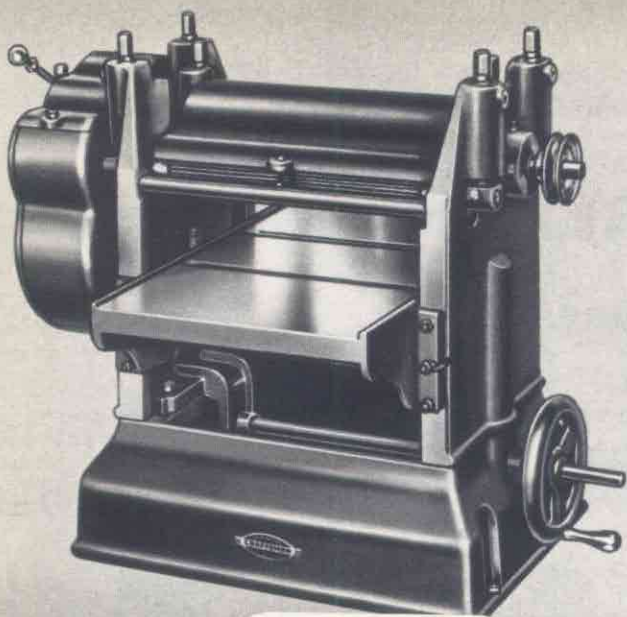

B
\$184⁵⁰ CASH
\$1850 DOWN



C
\$975⁰⁰ CASH
\$9750 DOWN

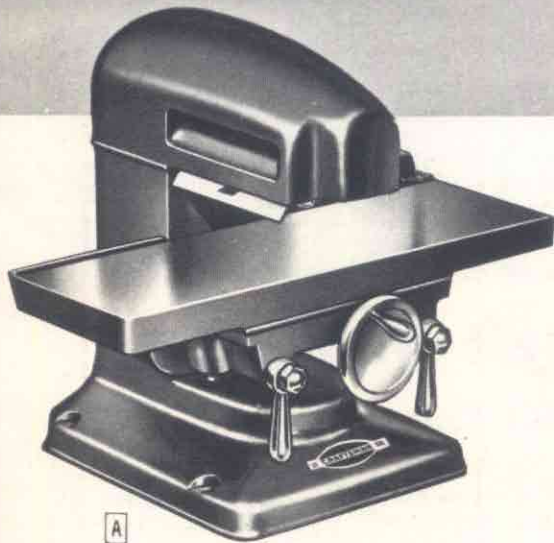

A
CRAFTSMAN Hand Feed Planer

A Now you can salvage old material... finish rough sawed lumber... reclaim marred or painted wood... make flat stock out of warped boards, etc.

Without motor
\$5350 CASH
\$5.50 DOWN

Large capacity. Planes material up to 6 in. wide and 2 in. thick... as small as 4 in. long and 1/8 in. thick. Open side design allows you to plane boards as wide as 12 in. Capacity of cut adjusted by hand wheel. Gives accurate operation... holds cut to within a few thousandths of an inch.

Rugged construction. Ribbed cast iron table and frame. Ways milled into one casting. Hand feed operation. Chip breaker and pressure bar guard head.

SPECIFICATIONS:

- Capacity of cut, maximum..... 3/32 inch
- Width of cut, maximum..... 6 inches
- Table size..... 65 1/4 x 19 1/4 inches
- Size of cutter head..... 2 3/8 inches diameter
- Knives..... three; size 6 1/2 x 1 1/2 x 3/8 inches
- Bearings..... 2 sets shielded precision ball
- Machine pulley (included)..... 2 inch
- Motor pulley (not included)..... 2 1/2 inch
- Motor recommended (min.)..... 1/2 H.P.; 3450 R.P.M.
- Mounting dimensions..... 8 x 10 inches
- Over-all dimensions: height 15 3/8 inches; width 15 3/4 inches; length 19 1/4 inches.

99 AM 2370—Without motor. Shpg. wt. 84 lbs. **\$53.50**

99 AM 2371—With 1/2 H.P. 3450 R.P.M. ball bearing capacitor motor for 110-120-volt 60-cycle A.C. 2 1/2-in. motor pulley, 1/2 x 58-in. V belt.

Shipping weight 122 pounds..... **\$82.50**

9 A 2293—Set of 3 extra knives for above planer.

Shipping weight 10 ounces..... **3.85**

CRAFTSMAN Thickness Planers
REG. U. S. PAT. OFF.

12-inch Power Feed Planer

B CRAFTSMAN "100" heavy-duty thickness planer... built with all the rugged sturdiness necessary to withstand daily high-production work. Does extremely accurate cutting... holds cut to within a few thousandths of an inch... balanced, extra-large 3 1/2-in. diameter cutter with three knives. Fast, smooth power feed. Easy-mesh gears run in oil. Heavy duty precision ball bearings.

Large capacity. Planes lumber up to 12 inches wide and 4 inches thick... as short as 6 inches and as thin as 1/16 inch. Maximum depth of a single cut is 3/32 inch depending on type of wood. Equipped with accurate depth-of-cut scale.

Heavily-ribbed table is accurately ground and fitted to one-piece, cast-iron frame by precision-machined ways. Easily raised and lowered by convenient handwheel to adjust depth of cut.

Solid steel feed rolls, 1 1/4-inch diameter, grip lumber and feed at rate of 17 lineal feet per minute. 12,000 cuts per minute when operated at the recommended speed of 4200 R.P.M.

SPECIFICATIONS:

- Capacity of cut, maximum..... 3/32 inch
- Width of cut, maximum..... 12 inches
- Table size..... 12x20 inches
- Size of cutter head..... 3 1/2 inches
- Knives..... three; size 12 x 3/8 x 1/8 inches
- Bearings..... 2 sets precision ball
- Power feed rate..... 17 lineal feet per minute
- Machine pulley (included)..... 3 inches
- Motor pulley (not included)..... 6 1/2 inches
- Motor recommended (variable)..... 3/4 to 2 H.P.; 1750 R.P.M.
- Recommended cutter head speed, approximately..... 4200 R.P.M.
- Mounting dimensions..... 8 3/4 x 18 3/4 inches
- Over-all dimensions: height 23 in.; width 33 in.; depth 20 in.

99 AM 2349F—Shipped from factory in Cincinnati from where you pay shipping charges when delivered. Without motor. Shipping weight 290 lbs.... **\$184.50**

20-inch Power Feed Planer

C It's NEW... it's BIG... it's our BEST! The CRAFTSMAN "100" 20-inch heavy duty thickness planer is designed to meet the planing needs of lumber mills, factories, and every type of woodworking shop... built to keep vibration to a very minimum, and to assure quality work, increased production and low operating costs.

Its range of speeds, 20 and 40 linear feet per minute, (or 40 and 80 linear feet per minute by changing sprocket) assures the user of a machine that can handle the heaviest type of roughing work or the finest cabinet finish and pattern shop planing with ease.

Extra-large capacity. Planes lumber up to 20 inches wide and 6 inches thick. Maximum depth of a single cut is 1/4 inch depending on type of wood. Scale indicates depth of cut; handwheel accurately adjusts.

Superior construction. Heavy welded base, alloy steel head, high-speed steel knives and hardened gears. Bed is of semi-steel; close-grained castings are supported by large anti-friction thrust bearings.

Safety-type cutter head mounted on heavy-duty ball bearings. Solid steel feed rolls 2 1/2 inches in diameter.

SPECIFICATIONS:

- Capacity of cut, maximum..... 3/8 inch
- Width of cut, maximum..... 20 inches
- Table size..... 34x20 inches
- Size of cutter head..... 4 1/2 inches
- Knives..... four; size 20x1x1/4 inches
- Bearings for cutter head..... 2 sets of precision ball
- Power feed rate..... 20 and 40 lineal feet per minute, or 40 and 80 lineal feet per minute
- Machine pulley (included)..... 3.4 inches
- Motor pulley (included)..... 2 step, 3.4 and 6.4 inches
- Motor recommended (variable)..... 3 to 10 H.P.; 1750 R.P.M.
- Recommended cutter head speed, approximately..... 3600 R.P.M.
- Over-all dimensions: height 47 inches; width 41 inches; depth 36 inches.

99 AM 2757F—Shipped from factory in Cincinnati from where you pay shipping charges when delivered. Without motor. Shipping weight 1240 pounds..... **\$975.00**

The two thickness planers shown above are not carried in stock or on display in many of our stores; however, shipment from factory can be made immediately. On such shipments there are fewer handling expenses... greater savings for you.



CRAFTSMAN 3-in. Portable Belt Sander

Exclusive 3-drum construction . . . Heavy duty G.E. Universal Motor

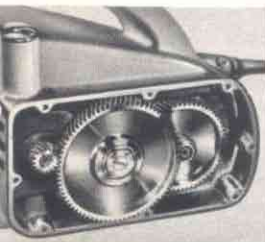

At left you see the spiral cut steel gears used in the CRAFTSMAN Portable Belt Sander. Exclusive 3-drum design makes possible a direct gear reduction from motor to drive shaft. No right-angle drive requiring a complicated arrangement of worm or bevel gears is needed.

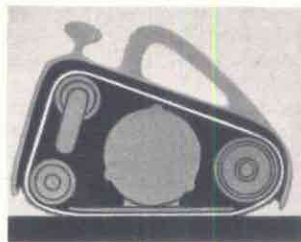

Notice, at left, how the 3-drum design makes possible more efficient construction and streamlined design. Sturdy motor is mounted in the center inside the housing for better efficiency, balance and handling. Permits use of a longer belt which gives you greater belt life.

Sanding Belts

B Replacement sanding belts for 99 A 02230 Portable Sander. Made of silicon carbide abrasive on cloth, 3x26 3/4 inches. Your choice of four grit sizes: 00 (extra fine), 0 (fine), 1 (medium) and 2 (coarse). *State grit size.* Shpg. wt. per belt 4 oz.
9 A 2231 32c

Lubricant

C Lubriplate No. 30 as specifically recommended for sanders 99 A 02230 and 99 A 02561. Comes in handy 2-oz. tube . . . just squeeze to apply whenever lubricant is needed. Shipping weight each tube 4 ounces.
9 A 2568 35c

Extension Cord

D 25-foot extension cord, for use with portable electric tools and all motors. Handy and safer! By using the proper size cord you assure full voltage at your motor or portable tool; lessen danger of motor burn-out from low voltage; get top-running efficiency.

25 feet of heavy No. 10 gauge wire; rubber covered. Type "SJ." Complete with heavy duty unbreakable rubber plug and connector. Approved by Underwriters. Shipping weight 4 lbs. 11 oz.
34 A 5884 \$4.49

Do your sanding the modern electric sander way! Save time . . . take this CRAFTSMAN Portable Belt Sander to the job. You'll be amazed . . . it's so lightweight and easy to handle. The frame and housing are made of strong die-cast aluminum . . . motor is mounted in the center . . . completely protected. Ideal for craftsmen, boat builders, cabinet makers, pattern makers, etc.

3-drum design. The great development in sander construction that is far superior to conventional 2-drum construction. It permits direct spiral gear reduction to drive shaft. No right angle drives or complex worm or bevel gearing. It also makes possible the modern functional design . . . gives minimum clearance on one side and front for getting into tight places and close to walls and corners. Underwriters' Laboratories Approved.

Superior sanding surface. The 26 3/4 x 3-inch sanding belt is longer and wider than belts used on conventional 2-drum sanders of the same general size. This sander produces a new, clean, smooth surface swiftly. And it means less wear and longer belt life with fewer belt changes. Metal shoe, on bottom of sander, keeps belt in even contact with work.

Smooth, easy operation. The convenient quick-change belt release lever is located on outside of housing. Just flip it and belt is loose . . . ready to be removed. All you do is replace belt, flip lever again and you're set to go back to work. All three drums are equipped with dust-protected, self-lubricating bronze bearings; extra large oil reserves. Built-in fan air cools the motor

SPECIFICATIONS:

- Belt size: width 3 inches
length 26 3/4 inches.
- Bearings: motor precision ball
drums self lubricating bronze
- Free speed of belt 1200 ft. per minute
- Gears spiral cut steel
- Belt release quick change, cam operated
- Motor G.E. universal, 110-120 volt AC-DC
- Switch safety trigger type; non-locking
- Over-all dimensions: Height 8 inches; length 11 1/4 inches; width 5 inches

Powerful G.E. universal ball-bearing motor (110-120 volt 25 to 60 cycle AC-DC) develops 3/4 H.P. maximum; has heat and abrasion-resistant Formex insulation that guards against motor "burn-out." This sander is safe, too. Will not run unless operator holds trigger switch in "on" position. With 10 feet of 3-wire cord, plug, 3 assorted belts and heavy duty all-steel carrying case.

A 99 A 02230—Shipping weight 18 pounds \$57.95

For all the details on Sears Easy Payment Plan, see inside front cover



With box and accessories

G \$38.95 CASH
\$400 DOWN ON TERMS

CRAFTSMAN Disc Sander, Buffer, Polisher

REG. U. S. PAT. OFF.

Will actually do the job 10 times faster than by hand

Accessories

A Adapter. Makes your CRAFTSMAN Sander-Polisher much more useful. Threaded shaft screws into shaft of Sander-Polisher. Can be used with any accessory that will fit 1/2-inch 20-thread spindle, such as chucks, brushes, etc. Steel flanges for clamping grinding wheels, buffing wheels, etc.

9 A 2564—Shipping weight 3 oz.49c

B Wire Cup Brush. Recommended for removing scale, paint, rust, weld splatter from rough metal surfaces, etc. Crimped steel wire bristles 1 1/2 in. long, rigidly held in a heavy cup-shaped metal holder. Brushing surface has 1 1/2 in. face. 2 3/4-in. outside diameter; 1/2-inch arbor hole. Use with adapter 9A2564.

9 A 6485—Shipping weight 4 oz.70c

C Floor Brush. For scrubbing, waxing, etc. 1-inch long Tampico fibers are securely set in 6-in. diam. hardwood block. Has 1/2-in. arbor hole. Use with adapter 9A2564.

9 A 6487—Shipping weight 11 oz. \$1.00

Chucks. For drills, carbon removing brushes, Roto-Verts, etc. Use with adapter 9A2564.

D 9 A 2175—Jacobs Hand Tite Chuck. Jacobs No. 4164. Capacity 0 to 1/4 in. Fits 1/2-in. 20-thread spindle. Postpaid. (Shpg. wt. 8 oz.) \$1.30

E 9 A 2248—CRAFTSMAN 3-jaw Chuck. Screw-on type. 0 to 1/4-inch capacity. Fits 1/2-in. 20-thread spindle. Shpg. wt. 5 oz.70c

F Lubricant. Lubriplate No. 30, for the CRAFTSMAN Sander Polisher. In handy 2-oz. tube. 9 A 2568—Shpg. wt. 3 oz.35c

Extra Sanding Discs. (Not illustrated.) Made with silicon carbide abrasive. Choice of four grits: 00 (extra fine), 0 (fine), 1 (medium), or 2 1/2 (coarse). Pkg. of 6 any one grit. State grit. 9 A 2562—Diam. 6 in. Shpg. wt. 7 oz.35c



Perfect for polishing cars, furniture, floors, linoleum, etc. A big work-saver!



Excellent for sanding curved or irregular surfaces; also floors, furniture, etc.

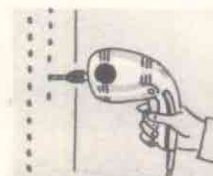

Can also be used for drilling, when equipped with adapter (sold separately).



Can be used with floor-polishing brushes with adapter (sold separately).

One of the most useful power tools we've EVER sold!

B No wonder it has become so tremendously popular! Has literally hundreds of uses! Really a jack-of-all-trades . . . and a master of all of them! You can use it for sanding, polishing and buffing on woodworking jobs, floors, walls, furniture, metals, etc. And even more, with the accessories listed at left, you can ALSO drill and grind; remove rust, scale, paint, etc.; and even scrub and wax floors. Can be used on wood, metal, plastic, concrete, stone, wallboard, etc., on either flat or curved surfaces.

A marvelous work saver. No rubbing! No pressing! No more aching arms and back! Just plug it in, snap the switch . . . and z-i-p . . . this machine does the job like magic. All you do is guide it. Men! See how swiftly it puts a beautiful polish on your car . . . and how easily it does so many sanding and buffing jobs in your shop. Women! Watch it sail through those many tiresome polishing tasks in the home. It weighs only 6 pounds . . . and is practically as easy to use as an electric iron.

Super quality construction throughout. Approved by Underwriters' Laboratories, Inc. A marvel of smooth, quiet operation because of the precision ball bearings and helical spur gears. Light, strong die cast aluminum alloy frame. Dual-purpose knob for 2-hand control

may be mounted on either side. Has a convenient non-locking trigger switch in the handle. Motor mounted directly over disc to provide maximum power and perfect balance. Heavy duty General Electric universal motor develops 1/4-H.P. maximum; has Formex insulation for longer motor life.

SPECIFICATIONS:

- Disc size, diameter 6 inches
- Over-all height, with disc 7 inches
- Bearings Precision ball
- Gears Helical spur
- Free speed of disc 1600 R.P.M.
- Switch Trigger type; non-locking
- Motor G.E. Universal type for 110-120 volt 25-60 cycle A.C. or D.C.
- Length of cord 10 feet

Accessories included. Comes complete with 10-ft. 3-wire rubber covered cord and plug, 6-inch flexible rubber sanding disc, 7-in. lamb's wool buffing bonnet, 6 assorted sanding discs, socket wrench for attaching discs, and handy all-steel carrying case which holds the sander and the accessories.

99 A 02561—CRAFTSMAN Electric Disc Sander-Polisher with accessories listed above. Shpg. wt. 12 lbs. . . \$38.95

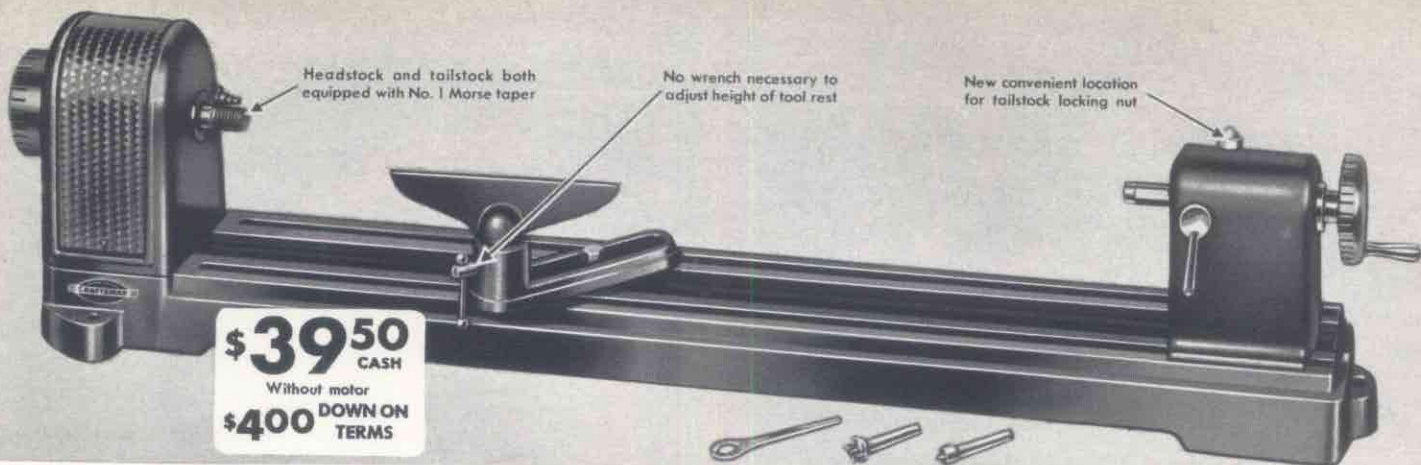

CRAFTSMAN "100" Ball-bearing Lathe

Ball Bearings in Headstock... Threaded Spindle

9-inch swing... 30 inches between centers... 46 1/2-inch bed. By far our finest production-type, wood-turning lathe. Extra-heavy-duty construction throughout.

Heavy cast semi-steel construction reduces vibration. Even under heavy cuts or high speeds this lathe operates with exceptional smoothness and accuracy. Sturdy, well braced bed. Three-point mounting helps eliminate twist and strain.

Two sets of precision radial thrust ball bearings—double-shielded and lubricated for life. Provide almost limitless service. Protected against grit and dirt. Assure longer life, greater accuracy.

No. 1 Morse taper in both headstock and tailstock. Easy to use with work arbor, drill chuck, etc. End cover removable. 3/4-inch x 16 left hand thread headstock spindle permits outboard turning of larger diameter work without reversing motor. Has indexing pin for use in fluting. May be driven from rear or below.

Complete with tool rest, spur and cup centers, wrench (for both tool-rest slide and tailstock), 4-inch 4-step machine pulley, 1/2x44-in. V-belt. Rust-resisting gray enamel finish. Chromium-plated hand wheels and headstock spindle cover.

SPECIFICATIONS:

- Spindle... 3/4-inch x 16 right hand thread inboard end; No. 1 Morse female taper 3/4-inch x 16 left hand thread, outboard
- Spindle speeds... Four: 875, 1350, 2250 and 3450 R.P.M.
- Tailstock taper... No. 1 Morse, female
- Tailstock ram travel... 2 3/4 inches
- Machine pulley (included)... 4-in. 4-step V type cone
- Motor pulley recommended (not included)... 4-in. 4-step V type cone
- Motor recommended (minimum)... 1/2 H.P.; 1750 R.P.M.
- Mounting dimensions (hole centers)... 7 1/4 x 43 1/2 in.
- Over-all dimensions... Height 10 1/4 in.; width 8 3/4 in.; length 50 1/2 in.

99 AM 2307—Without motor. Shipping weight 81 lbs. \$39.50
 99 AM 2195—With 1/2 H. P. split phase 1750 R.P.M. 110-120-volt 60-cycle A.C. bronze-bearing motor and 4-inch, 4-step motor pulley. Shpg. wt. 107 lbs. \$52.50



Accessories to make your lathe more useful

A "The Wood Lathe." CRAFTSMAN power tool book explains the construction and operation of the wood lathe. Full of helpful hints and technical and general information. It is full of actual photographs and step-by-step illustrations. Tells how to turn spindles, how to do grinding, sanding, finishing and many other operations. 32 pages. Shipping weight 2 ounces. 9 A 2920... \$35c

B Lathe Bed Extension. Exceptionally handy when you're doing extra long turning such as table legs, bed posts, lamp standards, etc. 18 inches long. Increases the distance between centers to anything you require. Heavy cast semi-steel in one piece. Ribbed and reinforced just like lathe bed. For lathe 99AM2307 above, or our earlier model 2318. 99 A 02488—Shipping weight 20 lbs... \$8.50

C Long Tool Rest. A great convenience when making long turnings such as table legs, bed posts, lamp spindles, etc. Makes it unnecessary to shift the standard tool rest down the bed. Full 20-inch length. Made of high-quality cast semi-steel... well machined and finished. Mounts rigidly on lathe bed. Readily adjusted for height. For lathe 99AM2307 above, or earlier model 2318. With one bed bracket. 9 A 2316—Shipping wt. 10 lbs... \$4.00

D High-grade Face Plates. Make your lathe much more useful. High-quality cast-iron construction. Complete with setscrew.

E For our earlier model 2318 lathe or any other lathe with 3/4-inch straight unthreaded spindle. 8-inch diameter. 9 A 2325—Shpg. wt. 2 lbs. 8 oz... \$3.50
F For 99 AM 2307 lathe above, or any other lathe with 3/4x16-thread spindle. Shipping weight each, 2 pounds. 9 A 2489—4-in. diam. (Inboard turning) \$2.00
 9 A 2490—8-in. diam. (Inboard turning)... 3.50
 9 A 2492—8-in. diam. (Outboard turning)... 3.50

G 3-inch diameter. Comes complete with spurs, removable center and screw center. For lathe 99 AM 2307 or any other lathe with 3/4 x 16-thread spindle. 9 A 2091—Shipping wt. 1 lb. 12 oz... \$1.80

H Sanding Plates. Carefully machined and balanced. Fitted with sandpaper. High-quality cast iron construction. For 99AM2307 lathe above or other 3/4-in. x 16 right-hand threaded spindles. 9 A 2491—8-in. diam. Shpg. wt. 2 lbs. 8 oz. \$3.50
 For 99A02160 lathe on opposite page or other 3/4-in. straight unthreaded spindles. 9 A 2341—8-in. diam. Shpg. wt. 2 lbs... \$3.10
 For our earlier model 2318 lathe or any lathe with 3/4-in. plain unthreaded spindle. 9 A 2308—8-in. diam. Shpg. wt. 2 lbs. 8 oz. \$3.50

I Jacobs Chuck Arbors. Precision ground... extremely accurate... to insure maximum accuracy of machine spindle and chuck performance. 9 A 2123—To fit chucks 9A2142 and 9A2143 on page 24. No. 1 Morse taper and No. 33 Jacobs taper. Postpaid. (Shipping weight 10 ounces)... 95c
 9 A 2154—To fit chucks 9A2129... 9A2144 and 9A2991 on page 24. No. 1 Morse taper and No. 3 Jacobs taper. Postpaid. (Shipping weight 12 oz.)... 95c

J Work Arbor. For mounting drill chucks and holding grinding, buffing and wire scratch wheels, etc. 3/4-inch x 20 thread. No. 1 Morse taper shank. 2 steel flanges with nut on head end for clamping wheels. 9 A 2153—Shpg. wt. 9 oz... 95c

K Work Arbor with Chuck. 3-jaw, screw-on type chuck, tapped 3/8-inch x 20 thread; 3/2-inch capacity. No. 1 Morse taper, shank end. 9 A 2234—Shipping weight 1 pound 8 oz... \$1.85

L Spur Centers. No. 1 Morse taper. 9 A 2106—Shpg. wt. 4 oz... 85c

M Tailstock Cup Centers. Supports work in tailstock. Ground and hardened steel with replaceable center point. No. 1 Morse taper. 9 A 2100—Shipping wt. 3 oz... 75c

N 60-degree Centers. No. 1 Morse taper shank. 9 A 2110—Shpg. wt. 3 oz... 70c

O Precision ball-bearing 60-degree center. (Center point rotates on ball bearing.) Recommended for high speed operations. No. 1 Morse taper. 9 A 2112—Shipping wt. 8 oz... \$2.90

P Screw Centers. For facing and hollowing operations. Replaceable center. No. 1 Morse taper. 9 A 2116—Shpg. wt. 12 oz... \$1.45

R CRAFTSMAN 4-jaw Independent Lathe Chuck. For lathe 99AM2307 above, or any lathe with 3/4-inch by 16-thread spindle. 4-inch diameter. Has four reversible jaws, drop forged from a solid bar of special steel, work independently. Especially useful for holding irregular shaped pieces. Large diameter jaw screw. Acme threaded. T-handle chuck wrench. 9 A 2156—Shpg. wt. 3 lbs. 10 oz. \$7.95



Headstock spindle rotates in 2 self-lubricating porous bronze bearings

Height of tool rest easily adjusted... with just a twist of the wrench

\$19.95 CASH
Without Motor
\$200 DOWN ON TERMS

DUNLAP Lathe . . new, low priced

OUR OWN TRADE MARK

Only \$2 down will put this fine Wood Turning Lathe in your shop

8-inch swing . . . 24 inches between centers . . . 36 $\frac{3}{4}$ -inch bed. We believe you will find it impossible to buy another lathe in this price range that matches this DUNLAP Lathe for quality features, performance and capacity.

Heavy cast semi-steel construction for smooth, accurate operation. Entire bed is made in one piece, ribbed and reinforced to reduce vibration to a minimum. All parts are accurately machined. 3-point mounting helps eliminate twist and strain. Tailstock easily and quickly adjusted.

Two self-lubricating porous bronze bearings and one ball thrust bearing in headstock. Oil well surrounds each bearing. This close, tight seal keeps spindle journals accurate—protects them against dirt and grit. Oil actually filters through bronze. Assures longer life and greater accuracy in operation. Ball thrust bearing absorbs spindle thrust to give smooth, accurate operation.

$\frac{3}{8}$ -inch straight unthreaded spindles in headstock and tailstock. Cover on outboard end of spindle; remove to use end of spindle for turning large diameter work. May be driven from the rear or below. Comes complete with tool rest, spur

and cup centers, wrench (for tool rest slide, tool rest, and tail stock lock) and 3-inch 3-step machine pulley. (V-belt not included.) Rust-resisting gray enamel finish.

SPECIFICATIONS:

- Spindle..... $\frac{3}{8}$ -inch straight unthreaded
- Spindle speeds..... Three: 1025, 1750 and 2985 R.P.M.
- Tailstock ram travel..... 1 $\frac{1}{2}$ inches
- Machine pulley (included)..... 3-inch 3-step V-type
- Motor pulley recommended (not included)..... 3-inch 3-step V-type
- Motor recommended (minimum)..... $\frac{1}{4}$ H.P. 1750 R.P.M.
- Mounting dimensions (hole centers)..... 33 $\frac{3}{4}$ x 6 in.
- Over-all dimensions..... Height 8 $\frac{3}{4}$ in.; width 7 in.; length 40 in.

99 A 02160—Without motor. Shipping weight 50 pounds..... **\$19.95**

99 AM 2193—With $\frac{1}{4}$ H.P. split phase 110-120-volt 60-cycle A.C. 1750 R.P.M. bronze bearing motor, 3-inch 3 step "V" type pulley, $\frac{1}{2}$ x36-inch "V" belt. Shipping weight 76 pounds..... **\$33.50**

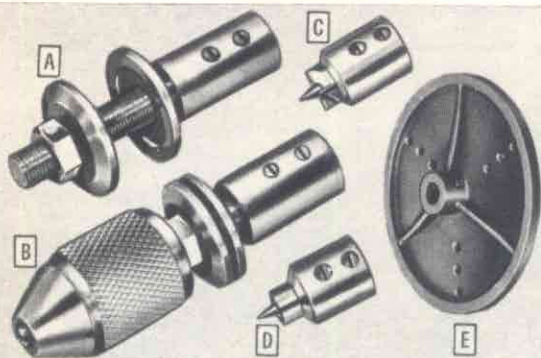

Arbors, Centers, Face Plates

A CRAFTSMAN General-purpose Work Arbor. Converts your lathe into a grinder, polisher, buffer, etc. Of carbon steel, 4 inches long. 2 $\frac{3}{4}$ -inch spindle has $\frac{3}{8}$ -inch x 20 thread. Steel flanges for clamping grinding or buffing wheels. Fits $\frac{1}{2}$ or $\frac{3}{8}$ -inch unthreaded shaft. Fastens with 2 set screws. State whether for $\frac{1}{2}$ or $\frac{3}{8}$ -inch spindle.
9 A 2164—Shipping weight 12 ounces..... **75c**

B Work Arbor with Chuck. 3-jaw, $\frac{1}{2}$ -inch capacity chuck and $\frac{1}{2}$ -inch x 20-thread arbor with steel flanges. Fits $\frac{1}{2}$ or $\frac{3}{8}$ -inch unthreaded straight spindle. Fastens with 2 set screws. State whether for $\frac{1}{2}$ or $\frac{3}{8}$ -inch spindle.
9 A 2151—Shipping weight 1 pound 10 ounces..... **\$1.50**

Lathe Centers. Ideal for use on any lathe with $\frac{3}{8}$ -inch straight spindle. Fasten with 2 set screws. Precision made of ground and polished steel. Specially designed for maximum strength and rigidity. Has replaceable center point.

C 9 A 2105—Headstock Spur Center. For driving work mounted between centers. Shipping weight 6 ounces..... **95c**

D 9 A 2102—Tailstock Cup Center. Supports work in tailstock. Shipping weight 6 ounces..... **95c**

E Face Plate. Makes your wood-turning lathe more useful. Excellent for many types of work which cannot be machined on centers or in a chuck and must be turned on outside or inside spindle with a face plate. Cast iron construction. For 99 A 02160 lathe above or any lathe with a $\frac{3}{8}$ -inch straight unthreaded spindle. 4-inch diameter. With set screw.
9 A 2320—Shipping weight 1 pound 5 ounces..... **\$1.65**

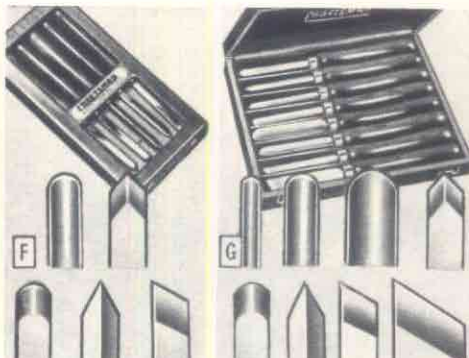

CRAFTSMAN Turning Chisels

In these fine chisels, you get genuine CRAFTSMAN quality at moderate prices. All have brightly polished 4-inch steel blades, carefully tempered to take and hold a keen edge for fast, clean cutting. Expertly ground. 8-inch handles of smoothly finished hardwood, securely fastened to blades. Heavy ferrule. Average over-all length 13 inches.

F 5-piece Chisel Set. Includes: $\frac{3}{8}$ -inch wide Gouge, $\frac{1}{2}$ -inch wide Spear Point Chisel, $\frac{1}{2}$ -inch wide Round Nose Chisel, $\frac{1}{2}$ -inch wide Parting Tool, $\frac{1}{2}$ -inch wide Skew Chisel. Shipping wt. 2 lbs. 4 oz.
9 A 2855..... 5-piece set **\$5.85**

G 8-piece Chisel Set. Includes one each of the following: $\frac{1}{4}$ -inch wide Gouge, $\frac{1}{2}$ -inch wide Gouge, $\frac{3}{8}$ -inch wide Gouge, $\frac{1}{2}$ -inch wide Spear Point Chisel, $\frac{1}{2}$ -inch Round Nose Chisel, $\frac{1}{2}$ -inch wide Parting Tool, $\frac{1}{2}$ -inch wide Skew Chisel, and 1-inch wide Skew Chisel. Set comes in sturdy wood box covered with attractive artificial leather. Shpg. wt. 8 lbs. 10 oz.
9 A 2853..... 8-piece set **\$11.50**

Individual Chisels. Shpg. wt. each 13 oz.
9 A 2850—Gouge, $\frac{1}{4}$ inch wide..... **\$1.25**
9 A 2851—Gouge, $\frac{1}{2}$ inch wide..... 1.35
9 A 2852—Gouge, $\frac{3}{8}$ inch wide..... 1.50
9 A 2854—Spear Point Chisel, $\frac{1}{2}$ inch wide..... 1.05
9 A 2856—Round Nose Chisel, $\frac{1}{2}$ inch wide..... 1.10
9 A 2858—Parting Tool, $\frac{1}{2}$ inch wide..... 1.30
9 A 2862—Skew Chisel, $\frac{1}{2}$ inch wide..... 1.10
9 A 2863—Skew Chisel, 1 inch wide..... 1.30

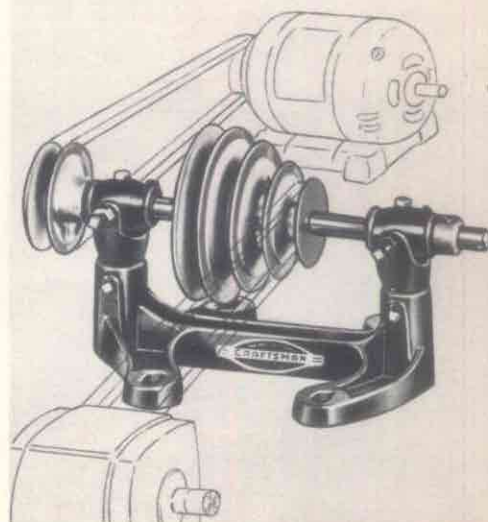

CRAFTSMAN Jack Shaft

Cone-pulley type. Used with matching cone pulley on machine. Provides broad speed variations on lathes, drill presses, grinders, etc. Speed is varied in certain definite steps. It is most commonly used between the motor and tool being driven. By changing drive pulley on motor, or driven pulley on jackshaft, a wide variety of speeds may be obtained.

Has self-aligning, self-lubricating porous bronze bearings with oil reservoirs. Cast iron base. Shaft of durable cold rolled steel. Die-cast pulleys. For use with $\frac{1}{2}$ -inch V-belts. Belts and motor not included. Shipping weight each 7 pounds 8 ounces.

9 A 2494—Please state size wanted.
With 4-inch 4-step pulley..... **\$6.00**
With 5-inch 4-step pulley..... **6.00**

Have you tried Sears Easy Payment Plan? It's so simple and easy to use . . . and just what you need to buy exactly what you want RIGHT NOW! For all the information on how you can use Sears Easy Terms, please turn to the inside front cover

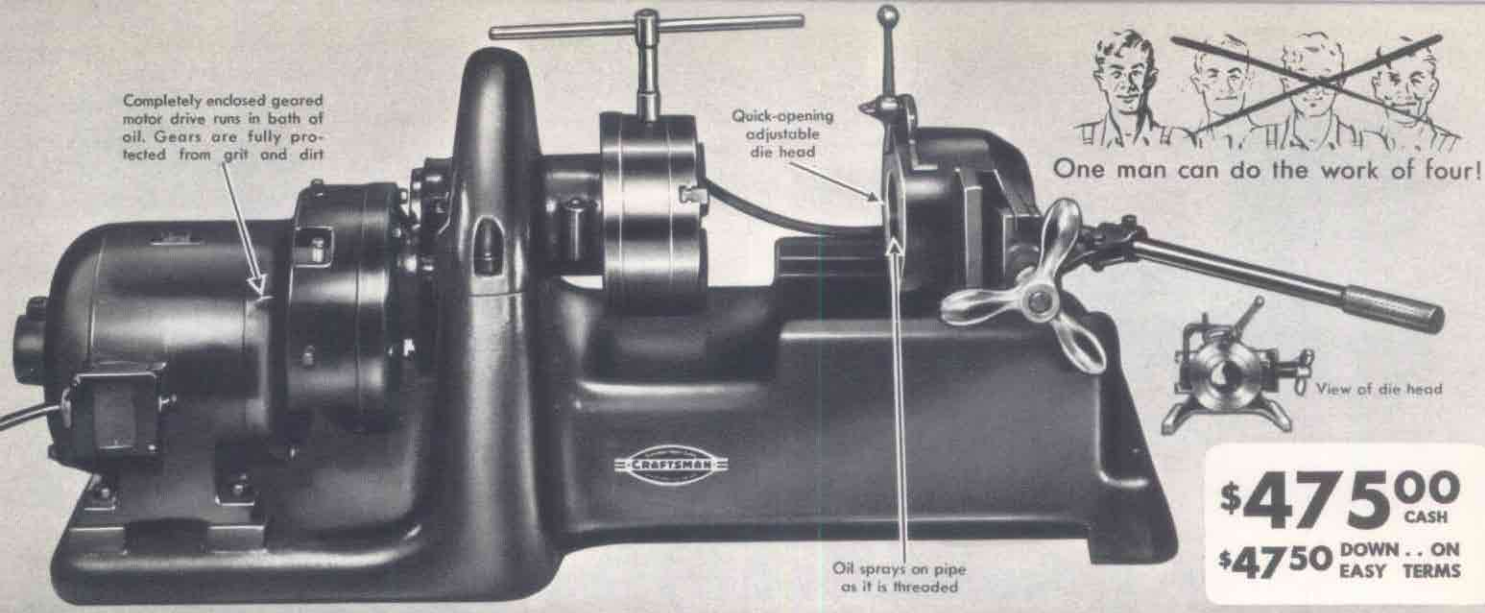

CRAFTSMAN Power Pipe Thread Cutter

REG. U.S. PAT. OFF.

It cuts! It reams! It makes much better threads!

One of the most important additions ever made to the famous CRAFTSMAN line! Contractors, plumbers, steamfitters, or anyone who threads large quantities of 1/2 to 2-in. diameter pipe, will find it gives tremendous savings in time, labor and money. Will pay for itself many times over. One man can place a big 2-inch diameter pipe in the machine, cut it off, ream it, thread it, and take it out . . . all in 1 1/4 minutes!

We had professional pipe fitters operate this tool, and they were amazed at its speed and accuracy. They agreed that it worked at least four times faster and did a better job than hand threading.

Extra heavy duty. Super quality construction throughout. Rugged cast iron frame. Can be used in a shop or transported on a small truck. Can be mounted on a bench or on braced pipe legs.

Quick-opening, cam-action, adjustable die head. Makes possible much faster, easier work than with a solid die head. Just flip handle to open head.

Three sets of die chasers. For iron or steel pipe; 1/2 or 3/4-in.; 1 or 1 1/4 in.; 1 1/2 or 2 in. (For die chasers to cut steel tubing, see listings at right.)

Power driven oil pump. Delivers a continuous stream of thread-cutting oil on the pipe where it is being threaded. Much better than hand oiling.

Heavy duty geared motor. 1/2-H.P. 1140 R.P.M. for 110 or 220-volt 60-cycle A.C. Enclosed 3-step gear assembly. Countershaft operates at 190 R.P.M.; drives 7 1/2-in. O.D. 3-jaw universal chuck at 32 R.P.M. Gears run in bath of oil. (Available with special voltage motors; consult your nearest Sears retail store or write Sears Personal Service Dept.)

Carriage travel 5 1/4 in. Width 20 in.; height 17 in.; length of base 41 in. With 5 gals. thread cutting oil. Power thread cutter and accessories shipped from factory in Philadelphia, Pa.; you pay transportation from there. If you wish more information, write for CRAFTSMAN Power Pipe Threader Booklet 620A.

- 99 AM 5560F—Shipping weight 450 lbs. \$475.00
- 9 A 5555F—Set of die chasers for iron or steel pipe. (3/4-1/2, 1-1 1/4, or 1 1/2-2 in.) State size. Shipping weight 2 pounds. \$8.00
- 9 A 5556F—Set of die chasers for steel tubing or conduit. Sizes as above. State size. Shpg. wt. 2 lbs. \$8.00
- 9 A 5557F—Extra reamer. Shpg. wt. 2 oz. 1.15
- 9 A 5558F—Extra guide roller for cut-off wheel. Shipping weight 6 ounces. 95c
- 9 A 5559F—Extra cut-off wheel with pin. Wt. 6 oz. \$1.25
- 9 A 5561F—5 gal. thread-cutting oil. Wt. 50 lbs. 4.25

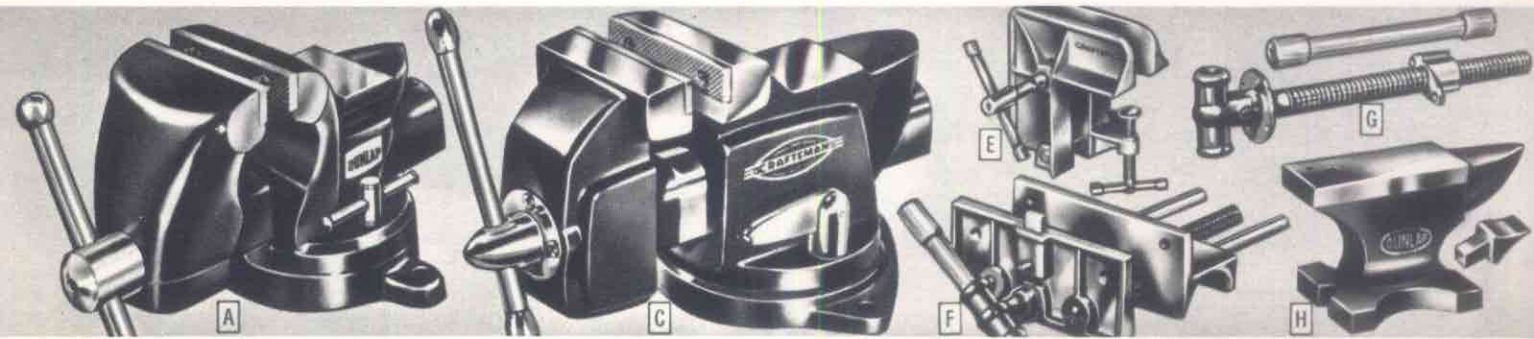

DUNLAP Bench Vise

A Good quality . . . priced low. Husky, semi-steel body strongly reinforced at all points of strain. Heavy U-shaped slide beam fits snugly, yet slides easily; jaws won't wobble. Smooth working Acme-threaded steel screw. Replaceable, oil-tempered, hardened steel jaw faces; deep-cut knurls assure firm, strong grip; hold objects rigidly. 3 1/2-in. jaws open to 4 1/2 inches. Swivel base turns left or right a full 180 degrees . . . has positive-locking three-point contact . . . locks securely in any position. Durable red finish. Actual weight 15 3/4 lbs. Mailable.

99 A 05244—DUNLAP Bench Vise only, as above. Shipping weight 17 lbs. \$7.85

99 A 05243—DUNLAP Bench Vise as above, plus set of pipe jaws. Shpg. wt. 23 lbs. \$8.25

B 9 A 5242—Pipe Jaws only. For Vise 99 A 05244 above. Shpg. wt. 1 lb. 4 oz. Pair 75c

CRAFTSMAN Bench Vise

C By far the finest vise of this type we've ever sold! Built for extra heavy duty . . . packed with rugged brute strength in every part. Body is strongly reinforced at all points of strain. All parts precision-machined, so that complete interchangeability is possible. Hardened and tempered, deep-knurled jaw faces . . . replaceable to permit longer vise life. Cold rolled steel "U" beam slides easily . . . fits snugly . . . prevents jaw wobble. Beam completely covers screw; protects it against dirt and filings. Acme-threaded steel screw has 6 threads per inch.

Oval stops at ends of handle help prevent pinched fingers. New-type handle on base; faster than sliding bar. Swivel base turns 360° . . . locks at any desired angle. Gray enamel finish; jaws, anvil and handles highly polished. Mailable.

99 A 05176—3 1/2-in. jaws open 5 in. Shpg. wt. 29 lbs. . . \$12.95
 99 A 05169—4-in. jaws open 5 in. Shpg. wt. 35 lbs. . . \$15.50
D 9 A 5167—Pipe Jaws only. For 99A05176 or 99A05169 vises. Shpg. wt. 1 lb. 4 oz. . . Pair 85c

Woodworkers' Vises

E Lightweight CRAFTSMAN Woodworkers' Vise. Light yet rugged. Easily carried in carpenters' kit. Cast aluminum jaws 5 1/2 x 5 1/4 in.; open to 2 3/4 in. Will fasten to anything from 7/8 to 2 1/4 in. thick. Acme thread screw. Screw holes in each jaw for fastening wood faces if desired. Holds work in vertical or horizontal position. Actual weight 2 3/4 lbs.
 9 A 5202—Shpg. wt. 3 lbs. \$3.25

F CRAFTSMAN Woodworkers' Vise. Heavy semi-steel front and back jaws; smooth ground faces; holes for fastening wood faces to jaws if desired. Adjustable bench stop on front jaw. Acme-threaded steel screw. 10-inch jaws; open to 10 inches.
 99 A 05200—Shpg. wt. 20 lbs. . . \$11.50
Quick-acting Woodworkers' Vise. (Not shown.) Similar to 99A05200 above, but half turn of handle disengages screw; permits jaw to slide back and forth. Turn in opposite direction again engages screw.
 99 A 05201—Shpg. wt. 20 lbs. . . \$14.50

Bench Screw

G Just the thing for replacement in old, worn-out bench vises, or for making new woodworkers' vises, fruit presses, etc. Strong steel screw, 1 inch in diameter; Acme-cut threads. 15 1/2 in. long. 14-in. hardwood handle. Shipping weight, 5 pounds 8 ounces.
 9 A 6662 \$1.85

20-pound Anvil

H DUNLAP. Ideal small anvil for small shop work, hobbyists, etc. Rugged semi-steel construction, with surfaces properly formed for making various shapes. Face size 6 3/4 x 2 3/4 in., with 3/4 x 3/4-in. hardy hole. Over-all size 10 x 5 1/2 in. With forged steel hardy. Actual weight is same as shipping weight. Shipping weight 20 pounds.
 99 A 05280 \$5.95

Precision built... yet very low in price! Guaranteed accurate within 1/1000 inch! Actually matches our larger screw-cutting lathes in precision and accuracy

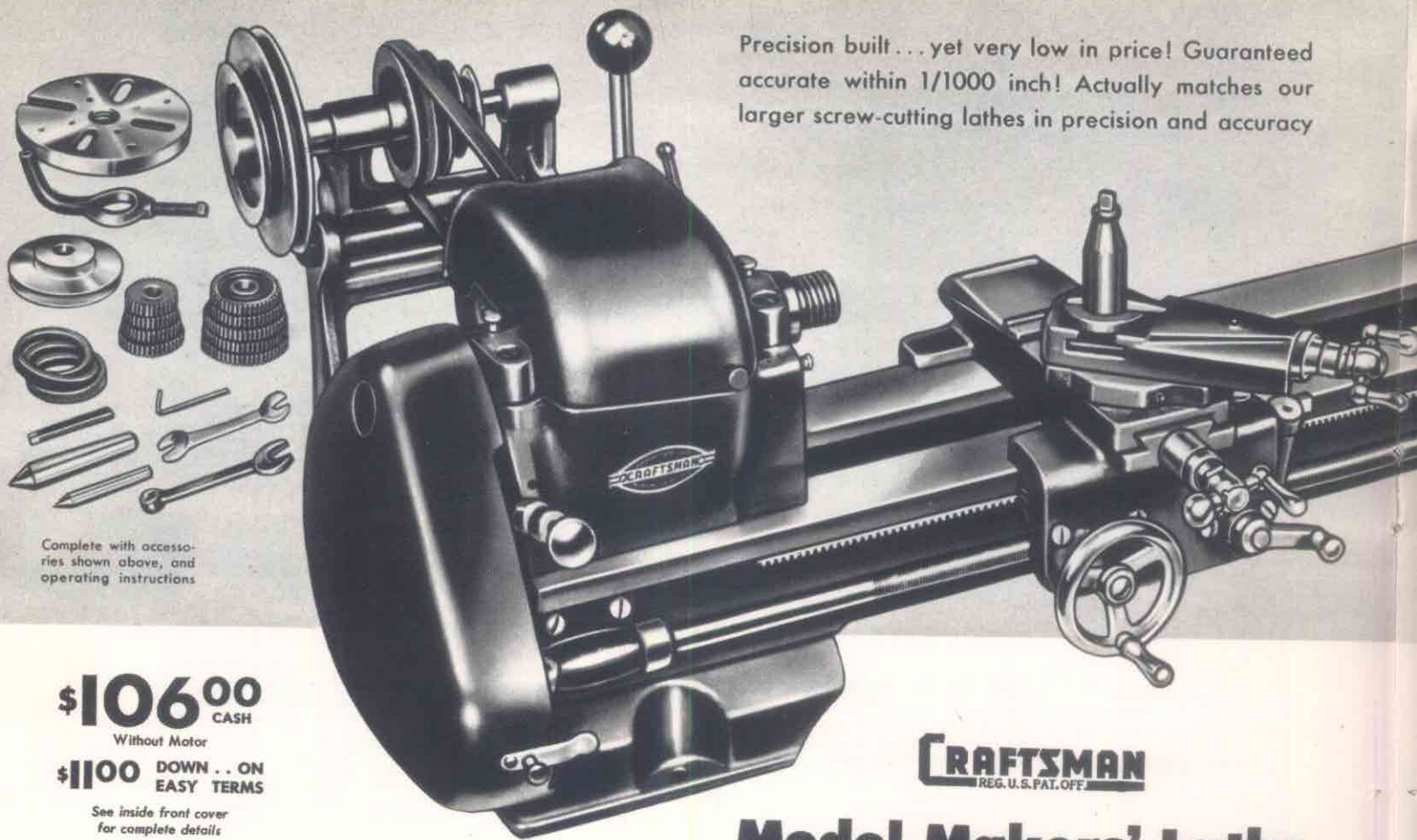

Complete with accessories shown above, and operating instructions

\$106⁰⁰
CASH

Without Motor

\$1100 DOWN .. ON
EASY TERMS

See inside front cover
for complete details

CRAFTSMAN
REG. U.S. PAT. OFF.

Model Makers' Lathe

Designed, built and priced for model makers, hobbyists, and tool makers... a fine shop tool that will give you precision performance on a wide variety of jobs.

Full 6-inch swing... 18 inches between centers... 30-inch bed. Massive, one-piece, cast semi-steel bed; precision ground. Carriage has hand wheel for manual operation and feed lever for reversible automatic power feed. Tailstock has set-over for taper turning.

Cuts 8 to 96 threads per inch, right or left hand. Back gears give 16 speeds from 54 to 3225 R.P.M. Graduated compound rest swivels 360°. Complete with 2-step motor pulley, 2-step machine pulley, 4-step countershaft, two 60-degree centers, 3/16-in. tool bit, 9 threading gears, 3/8-in. lathe dog, 3/8-in. V-belt, Allen wrench, 4-in. face plate and two wrenches.

SPECIFICATIONS:

- Swing over bed..... 6 inches
- Distance between centers..... 18 inches
- Spindle: Nose..... 1 inch x 8 thread
Taper..... No. 2 Morse
Bore..... 3/32 inch
- Spindle bearing... 2 porous bronze; 1 ball thrust
- Thread range..... 8 to 96, right or left hand
- Feeds..... Four: .0024, .0039, .0048 and .0078
- Back gear ratio..... approximately 63/5 to 1
- Countershaft and back gear bearings..... 4 porous bronze
- Swing over carriage..... 4 3/8 inches
- Compound rest travel..... 1 3/4 inches

- Cross slide travel..... 4 3/4 inches
- Tailstock taper..... No. 1 Morse
- Tailstock ram travel..... 1 1/4 inches
- Tailstock set-over..... 3/16 inch
- Motor recommended, minimum..... 1/4 H.P. 1750 R.P.M.
- Machine pulley (included)..... 2 step
- Motor pulley (included)..... 2 step
- Mounting dimensions..... 4 3/4 x 27 1/2 inches
- Over-all dimensions: Height 10 3/4 inches; width 21 3/4 inches; length 33 1/2 inches

Comes with instructions and accessories shown above.
99 AM 2048—Without motor.
Shipping weight 102 pounds..... **\$106.00**

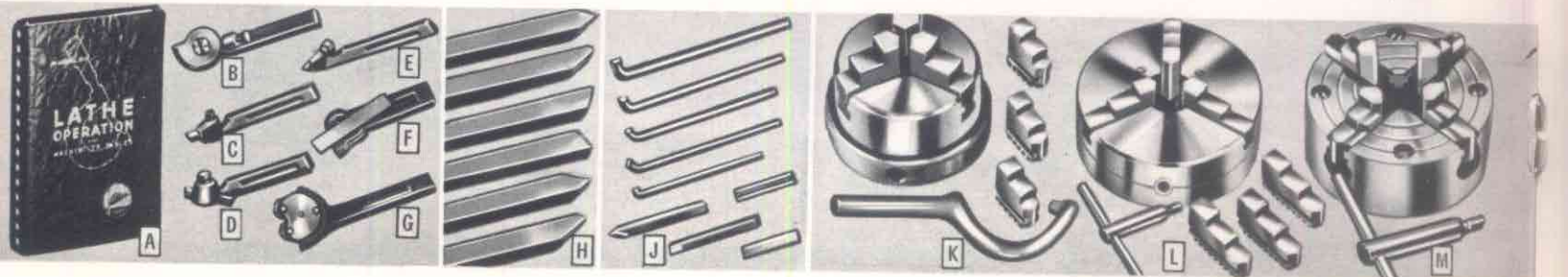

Metal Lathe Manual

A A complete, up-to-date, illustrated manual of metal lathe operations and machinists' tables. Easy-to-follow directions give you a sound, practical explanation of the construction of the metal lathe. An ideal book for students, apprentices, machinists and experienced lathe operators. Replete with actual photographs and pen and ink drawings. Each section separated by index tabs for convenience. Paper bound; spiral back. 234 pages. Shpg. wt. 11 oz.
9 A 2925..... **\$1.40**

Tool Holders

Fit 99 AM 2048 model makers' lathe above. Special drop forged steel, expertly heat treated and hardened.

B 9 A 2031—Threading Tool. Shpg. wt. 9 oz..... **\$4.60**

C 9 A 2033—Straight Tool Holder. No bit. Shpg. wt. 4 oz..... **\$2.10**

D 9 A 2034—Right Hand Tool Holder. No bit. Shpg. wt. 4 oz..... **\$2.10**

E 9 A 2035—Left Hand Tool Holder. No bit. Shpg. wt. 4 oz..... **\$2.10**

F 9 A 2037—Cut-off Tool. Shpg. wt. 7 oz..... **\$2.70**

G 9 A 2036—Knurling Tool. Has medium knurls. Shipping weight 9 oz..... **\$5.40**

Formed Tool Bit Set

H Six-piece set of 3/16-inch tool bits. High speed tool steel; ground, ready to use. Set includes threading bit, left-hand facing bit, left-hand turning bit, right-hand turning bit, right-hand facing bit, and round nose turning bit.
9 A 2043—Shpg. wt. 5 oz. **\$2.20**

Tool Post Set

J High speed tool steel. Tools mount directly in tool post. Set includes 4 boring bars, internal threading tool, external threading tool, external turning tool, and set of tool post spacers for height spacing.
9 A 2038—Shpg. wt. 1 lb. **\$7.75**

CRAFTSMAN precision made Lathe Chucks

K CRAFTSMAN 3-jaw Universal type. Self-centering, lever-operated... only two main parts, body and scroll. Ideal for production work. Holds tolerances to within .003 in. Steel jaws; steel body and scroll. Knurled rim. Fits 99 AM 2048 lathe above, or any 1-in. x 8-thread spindle. Diameter 4 in. Two sets of jaws; one for outside, one for inside gripping. With wrench. Shpg. wt. 6 lbs. 5 oz.
9 A 2297..... **\$20.50**

L 3-jaw Universal type. Jaws controlled by single screw and pinion gear... speedy gripping... self-centering... ideal for production work. Extra-strong semi-steel body casting. Special alloy metal scroll; alloy steel pinion. Alloy steel jaws. Fits 99 AM 2048 lathe above, or any 1-in. x 8-thread spindle. 4 in. diam. Has 2 sets of jaws (outside and inside). With T-handle chuck wrench. Shipping wt. 5 lbs. 3 oz.
9 A 2148..... **\$35.00**

M 4-jaw Independent type. For average shop needs. Special alloy steel body has wide, deep jaw slots. Four reversible jaws work independently; increase usefulness when working on irregular shaped pieces. Large diameter jaw screw. Acme threaded. Fits 99 AM 2048 lathe above, or any 1-in. x 8-thread spindle. Diameter 4 in. With T-handle chuck wrench; fits deep seat. Shpg. wt. 3 lbs. 12 oz.
9 A 2138..... **\$7.95**

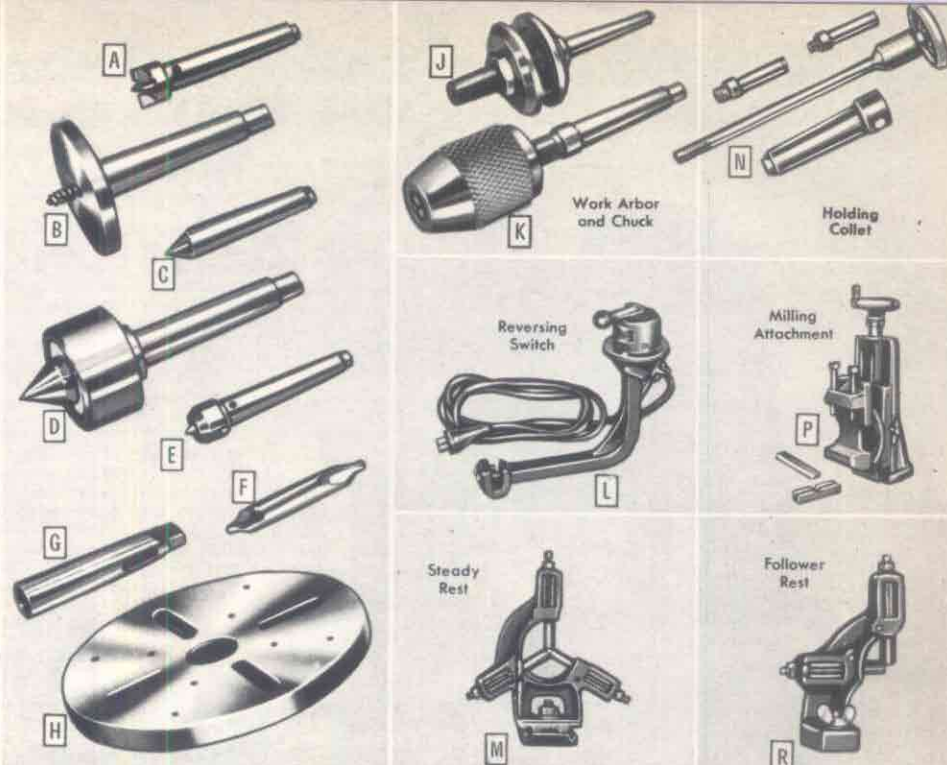
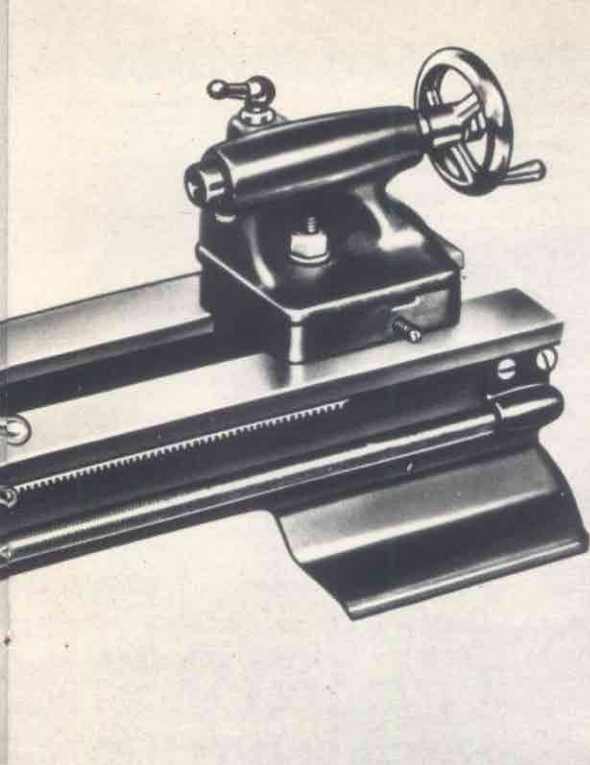

Accessories for CRAFTSMAN Model Makers' Lathe . . . make it more useful

- | | | | |
|---|---|--|---|
| <p>A Spur Centers. Use for wood turning. 9 A 2106—No. 1 Morse taper shank. Shipping weight 4 oz. . . . 85c
9 A 2107—No. 2 Morse taper shank. Shipping weight 7 oz. . . . 87c</p> <p>B Screw Centers. For facing and hollowing operations. Replaceable center. 9 A 2116—No. 1 Morse taper shank. Shipping weight 12 oz. . . . \$1.45
9 A 2115—No. 2 Morse taper shank. Shipping weight 14 oz. . . . 1.45</p> <p>C 60-degree Centers. For metal. 9 A 2110—No. 1 Morse taper shank. Shipping weight 3 oz.70c
9 A 2111—No. 2 Morse taper shank. Shipping weight 7 oz.75c</p> <p>D Precision ball bearing 60-degree center. (Center point rotates on ball bearing.) For high speed operations. 9 A 2112—No. 1 Morse taper shank. Shipping weight 8 oz. . . . \$2.90
9 A 2113—No. 2 Morse taper shank. Shipping weight 8 oz. . . . 2.90</p> | <p>E Tailstock Cup Centers. Supports work in tailstock. Replaceable center point. 9 A 2100—No. 1 Morse taper shank. Shpg. wt. 3 oz. . . . 75c
9 A 2101—No. 2 Morse taper shank. Shpg. wt. 7 oz. . . . 87c</p> <p>F Center Drill. Combination drill and countersink. In $\frac{3}{32}$ or $\frac{1}{8}$-in. size. <i>State size wanted.</i> 9 A 2061—Shpg. wt. 1 oz. . . . 45c</p> <p>G Adapter Sleeve. No. 2 Morse taper reduces to No. 1 Morse taper. Shpg. wt. 5 oz. . . . \$1.30
9 A 2161 \$1.30</p> <p>H Face Plate. Use for driving lathe dog and work for wood turning. 4-in. diameter. For use on 99AM2048 lathe (on opposite page) and other lathes with 1-in. 8-thread spindle. Shipping weight 3 lbs. 9 A 2470 \$3.20</p> | <p>J Work Arbor. For mounting chucks and holding grinding, buffing and wire scratch wheels, etc. $\frac{3}{8}$-in. x 20-thread. 2 steel flanges with nut on head end for clamping wheels. Morse taper shank. 9 A 2152—No. 2 Morse taper shank. Shipping weight 11 ounces. . . . 95c
9 A 2153—No. 1 Morse taper shank. Shipping weight 9 ounces. . . . 95c</p> <p>K Work Arbor with Chuck. 3-jaw, screw-on type chuck, tapped $\frac{1}{2}$-in. x 20-thread; $\frac{1}{4}$-in. capacity. Work arbor has Morse taper on shank end. 9 A 2247—No. 2 Morse taper with chuck and arbor. Shipping weight 1 pound 8 ounces. . . . \$1.90
9 A 2234—No. 1 Morse taper with chuck and arbor. Shipping weight 1 pound 8 ounces. . . . 1.85</p> <p>L Reversing Switch. Reverses motor and spindle direction in grinding, polishing, tapping, wood or metal finishing. Not for repulsion-induction motors. 9 A 2039—Shipping weight 4 lbs. 6 oz. . . . \$9.25</p> <p>M Steady Rest. Base clamps securely to bed ways. Gives added support needed when turning long pieces. Handles diameters up to 2$\frac{3}{4}$ inches. 9 A 2041—Shipping weight 3 lbs. 4 oz. . . . \$6.00</p> | <p>N Holding Collet. This attachment fits in the headstock spindle; will hold threaded-hole angular milling cutters, keyway cutters and $\frac{1}{2}$-inch end mills. Shipping weight 2 lbs. 9 A 2059 \$8.85</p> <p>P Milling Attachment. Has graduated swivel vise, flat block and V-block for holding cylindrical objects. Vise capacity 2 inches; vertical feed 1$\frac{3}{4}$ inches. Graduated angular swivel. Shipping weight 8 lbs. 4 oz. . . . \$21.00
9 A 2057 \$21.00</p> <p>R Follower Rest. Mounts on back of carriage dovetail slide . . . moves with cutting tool to provide support needed to prevent deflection when turning long, slender work. Shipping weight 1 pound 9 ounces. 9 A 2042 \$4.15</p> |
|---|---|--|---|

CRAFTSMAN "80" Power Hack Saw

Heavy duty . . . semi-automatic
Cuts accurately unattended

Save time . . . save labor . . . reduce operating costs . . . speed up production with this CRAFTSMAN "80" Power Hack Saw. Professional quality throughout. Ideal for plumbers, electricians, garage men and other metal workers.

Extra large capacity. Makes cuts on material up to 4x4 in. at 90°. Makes angle cuts 90° to 45°. Saws iron, steel, brass, aluminum, etc.; quickly and accurately. It has a 5-inch stroke; 60 strokes per minute, at 400 R.P.M.

Makes the cut alone while you work on other jobs. Draw-cut type, with automatic relieving mechanism to lift blade from work on the back stroke. Gives a clean, accurate cut.

Rugged construction. Heavy cast iron vise; quick-locking. Shafts run on porous bronze bearings. Cast semi-steel slide and arm. Cone type arm pivot; adjustable. Takes any standard 12-in. power hack saw blade (one included).

SPECIFICATIONS:

- Capacity, maximum. 4x4 inches
- Angle cuts. 90 to 45 degrees
- Bearings. porous bronze
- Length of blade. 12 inches
- Width of blade. $\frac{3}{4}$ inch
- Machine pulley (included). 6 $\frac{1}{4}$ -inch
- Motor pulley (not included). 1 $\frac{1}{2}$ -inch
- Motor recommended, minimum. $\frac{1}{2}$ H.P. 1750 R.P.M.
- Base size. 6x24 inches
- Mounting dimensions. 3 $\frac{1}{4}$ x19 $\frac{3}{8}$ inches
- Over-all dimensions: height 10 inches; width 9 inches; length (extended) 29 (not extended) 26 in.

99 AM 2294—Without motor. Shpg. wt. 60 lbs. **\$45.00**

9 A 6582—CRAFTSMAN 12-inch power hack saw blades.

Special tool steel, $\frac{3}{8}$ in. wide. 14 or 18 teeth per in.

State choice wanted. Shpg. wt. 3 oz. **2 for \$1.19**

\$45⁰⁰
CASH

Without Motor

\$450 DOWN . . ON
EASY TERMS



CRAFTSMAN Metal Lathe... Guaranteed Accurate to

- Two famous TIMKEN roller bearings maintain spindle alignment and absorb radial thrust load. These bearings assure exceptionally accurate operation.
- Reversible power cross feed makes facing work faster and easier.
- Hinged guards completely cover headstock and motor drive pulleys for utmost safety.

This great CRAFTSMAN Lathe is by far the finest we have ever sold. Because of its extra heavy duty design and its superb precision construction, it cuts accurately to within 1/1000 inch even after years of service. It is built to meet the most exacting requirements of master craftsmen and industrial shops.

Two very important features! (1) The TIMKEN tapered roller bearings are particularly desirable on production work where high speed counts; they assure smooth, fast, accurate cutting performance even at high spindle speeds. (2) The reversible power cross feed makes it possible to do facing work much more accurately—automatically!

Husky back gears make slow speeds and extra power available for heavy cuts. Headstock has indexing device so work can be evenly divided or fluted. Countershaft is part of lathe; complete with motor mounting.

Rugged, massive construction. Heavily reinforced cast semi-steel bed with precision-ground ways. Tailstock has 3/4-inch set for turning tapers; is fitted with center ejector and coordinate ram lock. V-belt drive has adjustable belt tension and release lever.

Heavy semi-steel carriage has adjustable gibs for take-up. Reversible longitudinal feed is provided to the carriage. Threading dial is supplied as standard equipment. Cuts metric as well as standard threads. Compound rest swivels and locks at any angle, and is graduated in one-degree divisions from 0 to 180 degrees. With tool post wrench, threading gears, 2 centers, Allen wrench, motor pulley, belt, and 234-page illustrated lathe manual.

99 AM2075—24 inches between centers. Shipping weight 275 pounds. \$210.00
99 AM2079—36 inches between centers. Shipping weight 295 pounds. 230.00



234-page Manual of Lathe Operation is included with these CRAFTSMAN Metal Turning Lathes

\$210.00 CASH
99 AM 2075
\$21.00 DOWN... ON EASY TERMS

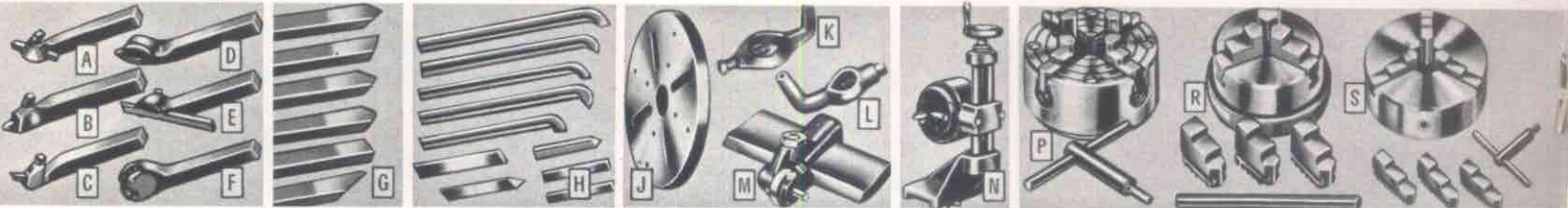

High-Quality Accessories for the CRAFTSMAN Metal-Turning Lathe Above

Tool Holders. Steel forgings. Shanks 3/4-in. high; 3/8-in. wide. Shpg. wt. 10 oz.
(A) 9 A 2194—Offset, left. \$2.15
(B) 9 A 2192—Offset, right. \$2.15
(C) 9 A 2196—Straight. 2.15
(D) 9 A 2198—Threading. 4.80
(E) 9 A 2200—Cut-off. 2.95
(F) 9 A 2202—Knurling tool. 5.75

G Six Formed Tool Bits. 3/8-in. Fit holders above. Threading, left hand facing, right hand facing, round nose turning, right hand turning, and left hand turning bits.
9 A 2205—Shpg. wt. 8 oz. \$2.25

H Tool Post Set. Includes 4 boring tools (3/8, 1/2, 5/8, and 3/4 inch); 3/8-inch inside threading tool; 3/8-inch turning tool; 3/8-inch threading tool; set of tool post spacers.
9 A 2189—Shpg. wt. 1 lb. 1 oz. \$8.00

J Face Plates. For lathe with 1 1/2-in. 8-thread spindle (as on lathe above).
9 A 2471—4-in. Shpg. wt. 3 lbs. \$3.20
9 A 2475—8-in. Shpg. wt. 6 lbs. 4.70
For lathes with 1-in. 8-thread spindle.
9 A 2470—4-in. Shpg. wt. 3 lbs. \$3.20
For lathes with 3/4-in. 16-thread spindle.
9 A 2469—4-in. Shpg. wt. 3 lbs. \$3.20
9 A 2473—8-in. Shpg. wt. 6 lbs. 4.70
For lathes with 1 1/2-in. 20-thread spindle.
9 A 2468—4-in. Shpg. wt. 3 lbs. \$3.20

K Lathe Dog. Malleable iron. 1/2, 3/4, 1 or 1 1/4 in. size. State size.
9 A 2078—Shpg. wt. 8 oz. 45c

L Lathe Dog. Forged steel. Heat treated set screw. Shpg. wt., each, 1 lb.
9 A 2183—State size wanted.
3/4-inch. 87c 1-inch. \$1.00
3/8-inch. 98c 1 1/4-inch. 1.15

M Micrometer Carriage Stop. Has adjustable micrometer stop for stopping carriage in boring or facing to a given depth, duplicating longitudinal cuts, etc. Clamps on bed way. Shipping wt. 1 lb.
9 A 2185 \$5.00

N Mica Undercutter. Screw feed regulates height of cutter and carriage feed moves cutter into commutator slot. With motor, switch, cord, set of 5 undercutting saws. For 110-120 volt 25-60 cycle A.C. or D.C. Shipping weight 11 pounds.
9 A 2989 \$40.00

P CRAFTSMAN 4-Jaw Independent Chuck. Four reversible jaws work independently. Acme threaded. T-handle chuck wrench.
9 A 2139—Fits 1 1/2-in. 8-thread spindle. Diameter 6 in. Shpg. wt. 9 lbs. 10 oz. \$14.95
99 A 02141—Fits 1 1/2-in. 8-thread spindle. Diameter 8 in. Shpg. wt. 25 lbs. \$26.95

R CRAFTSMAN 3-jaw Universal Chuck. Two sets of jaws; one for outside and one for inside gripping. Spanner wrench included.
9 A 2298—Fits 1 1/2-in. by 8-thread spindle. Diameter 5 in. Shpg. wt. 10 lbs. \$25.50
99 A 02299—Fits 1 1/2 by 8-thread spindle. Diameter 6 inches. Shpg. wt. 15 lbs. \$32.50

S CRAFTSMAN 3-jaw Universal Chuck. Pinion gear type. Two sets of jaws (outside and inside). Square socket chuck wrench.
9 A 2150—Fits 1 1/2-in. by 8-thread spindle. Diameter 5 in. Shpg. wt. 7 lbs. 14 oz. \$36.50

one-thousandth inch

SPECIFICATIONS:	99 AM 2075	99 AM 2079
• Swing over bed.....	12 3/4 inches.	12 3/4 inches
• Distance between centers.....	24 inches.	36 inches
• Spindle, Nose size.....	1 1/2 in.; 8 thread.....	1 1/2 in.; 8 thread
Taper.....	No. 2 Morse.....	No. 2 Morse
Bore.....	2 5/16 in.....	2 5/16 in.
• Spindle bearing.....	2 Timken Roller.....	2 Timken Roller
• Thread range.....	4 to 96 R.H. or L.H.....	4 to 96 R.H. or L.H.
• Feeds.....	.0024; .0035; .005; .0071; .0087	
• Back gear ratio.....	Approx. 6 to 1.....	Approx. 6 to 1
• Countershaft and back gear bearings.....	4 porous bronze.....	4 porous bronze
• Swing over carriage.....	8 3/8 inches.....	8 3/8 inches
• Compound rest travel.....	2 9/16 inches.....	2 9/16 inches
• Cross feed.....	Reversible; power feed.....	Reversible; power feed
• Tailstock taper.....	No. 2 Morse taper.....	No. 2 Morse taper
• Tailstock set over.....	3/4 inch.....	3/4 inch
• Machine pulley (included).....	6-inch 4-step.....	6-inch 4-step
• Motor pulley (included).....	4 1/2-inch 2-step.....	4 1/2-inch 2-step
• Speeds.....	Sixteen.....	28 to 2072 R.P.M.
• Mounting dimensions.....	6 3/16 x 35 1/16 in.....	6 3/16 x 47 1/16 in.
• Over-all dimensions.....	Height 20 inches.....	20 inches
	Width 25 1/2 inches.....	25 1/2 inches
	Length 45 inches.....	57 inches

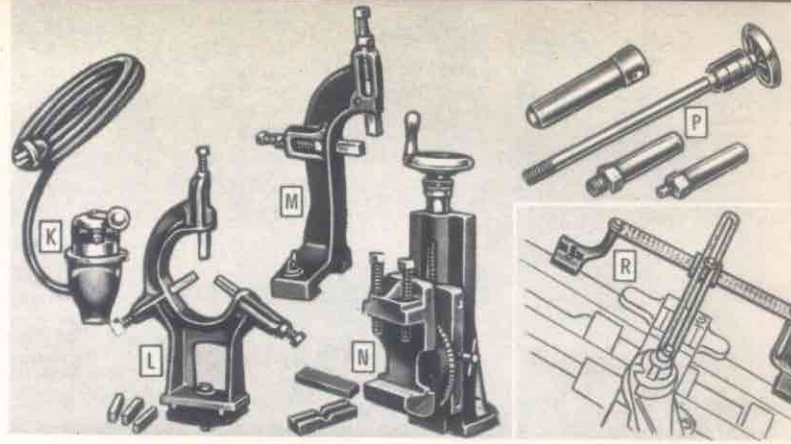

High Quality Lathe Accessories

- K Reversing Switch.** Drum type reversing switch that is essential for grinding, tapping and all types of fine metal and wood finishing. The reversing motor reverses direction of lathe spindle. (Note: Do not use with repulsion-induction motors.) Comes with cord and plug.
9 A 2983—Shpg. wt. 5 lbs..... **\$10.35**
- L Steady Rest.** The sturdy solid brass jaws give rigid support to insure accuracy in turning, boring, and threading on your lathe. Especially useful for accuracy when turning, boring or threading long slender pieces. Clamps securely and rigidly to the bed ways. Has a capacity up to 2 1/2 inches. Complete with extra jaws. Ready for use.
9 A 2050—Shpg. wt. 6 lbs. 6 oz..... **\$7.80**
- M Follower Rest.** Gives the necessary support for jobs that require a long cut on a small diameter. Fastens securely to the back of carriage dovetail slide... follows the cutting tool. Essential for long, slender pieces.
9 A 2988—Shpg. wt. 3 lbs. 10 oz..... **\$5.50**
- N Milling Attachment.** Complete as shown, with graduated swivel vise and V-block for holding cylindrical objects. Vise capacity 2 3/8 in. Vertical feed 3 3/8 in. Cross feed 5 in. Graduated micrometer feed screw. Angular swivel accurately graduated in degrees.
99 A 02987—Shpg. wt. 18 lbs... **\$24.95**
- P Holding Collet.** For use on straight shank milling cutters. Furnished with two arbors, one to take threaded hole angular cutters, etc. Hand wheel.
9 A 2994—Shpg. wt. 2 lbs. 8 oz... **\$9.35**
9 A 2985—Four bushings for use with 1/4, 3/16, 1/8 and 1/16 inch end mills. Shipping weight 2 oz..... **\$2.30**
- R Taper Attachment.** You don't have to move the tailstock out of alignment when you use this attachment. Duplicate tapers can be cut accurately on pieces of different lengths. Internal boring can be done as easily as external work. Index plate is graduated 7° and 3 inches both sides of center line. Equivalent to taper of 2 1/16 inches per foot.
9 A 2984—Shpg. wt. 10 lbs..... **\$24.00**

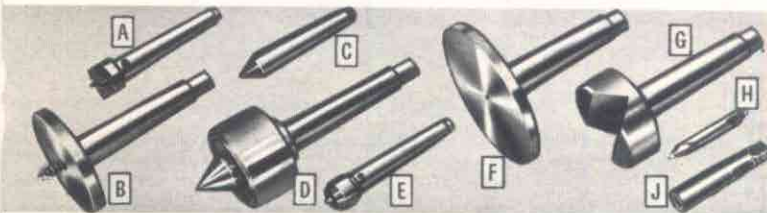
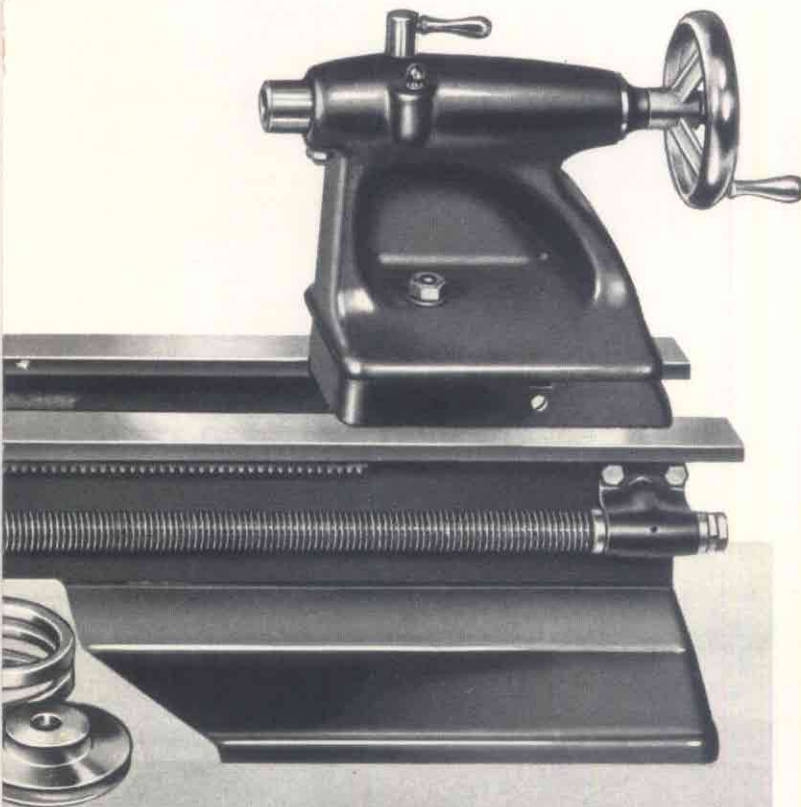

Lathe Centers and other Accessories

- A Spur Center.** Use for wood turning. No. 2 Morse taper.
9 A 2107—Shpg. wt. 7 oz..... **.87c**
- B Screw Center.** For facing and hollowing operations. Replaceable center. No. 2 Morse taper.
9 A 2115—Shpg. wt. 14 oz..... **\$1.45**
- C 60-degree Center.** Precision ground. No. 2 Morse taper.
9 A 2111—Shpg. wt. 7 oz..... **.75c**
- D Precision ball bearing 60-degree Center.** Center point rotates on ball bearing. Recommended for high speed operations. No. 2 Morse taper.
9 A 2113—Shpg. wt. 8 oz..... **\$2.90**
- E Tailstock Cup Center.** Supports work in tailstock. Ground and hardened steel with replaceable center point. No. 2 Morse taper.
9 A 2101—Shpg. wt. 7 oz..... **.87c**
- F Drill Pad.** Used in tailstock of lathe to provide rigid support for drilling flat or square work. Diameter of face is 3 1/2 inches. No. 2 Morse taper. Shipping wt. 1 lb. 2 oz.
9 A 2187..... **\$1.45**
- G Crotch Center.** Automatically centers round work in tailstock of lathe for accurate cross drilling. V-slot is precision machined. No. 2 Morse taper.
9 A 2114—Shpg. wt. 1 lb..... **\$1.45**
- H Center Drill.** Combination drill and countersink. Tempered steel. Gives correct bearing for 60° centers. In 3/32 or 1/8-in. size. *State size wanted.*
9 A 2061—Shpg. wt. 1 oz..... **.45c**
- J Adapter Sleeve.** To reduce from No. 2 to No. 1 Morse taper.
9 A 2161—Shpg. wt. 5 oz..... **\$1.30**

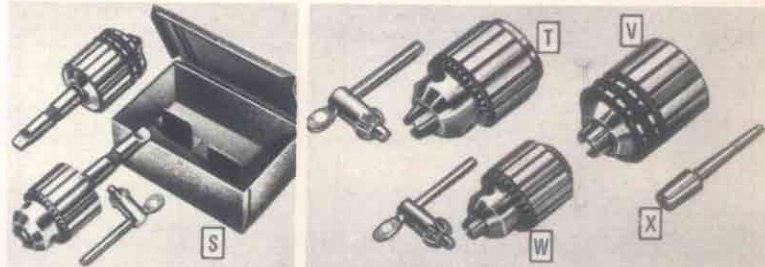

Nationally-famous Jacobs Chucks

- S Jacobs Commutator Kit.** For holding armature shafts rigidly during reconditioning. Kit includes: No. 75A armature driving chuck; No. 100 center rest chuck (1/4 to 3/4-in. capacity); two arbors (No. 2 Morse taper, shank end; No. 3 Jacobs taper, head end); chuck key. In strong metal box. Same price cash or terms.
9 A 2129T—Postpaid. (Shipping weight 7 pounds 4 ounces)..... **\$21.47**
- T Jacobs Headstock Chucks.** Nationally famous. Extremely accurate.
9 A 2144—Jacobs No. 58B. 1/2 to 3/8 in. Fits 1 1/2-in., 8-thread spindle.
9 A 2121—Jacobs No. 59B. 3/16 to 1/4 in. Fits only 1 1/2-in., 8-thread spindle. Can't be used with an arbor. Postpaid. (Shpg. wt. 5 lbs. 8 oz.)..... **\$18.76**
- V Jacobs Center Rest Chuck.** Jacobs No. 100CR. Capacity 1/4 to 3/4 in. Must be used with No. 3 Jacobs taper arbor.
9 A 2991—Postpaid. (Shipping weight 3 pounds 2 ounces)..... **\$10.45**
- W Jacobs Drill Chucks.** For No. 33 Jacobs taper arbor.
9 A 2142—Jacobs No. 33 key-type chuck. Fits arbors with No. 33 Jacobs taper. Capacity 5/64 to 1/2 in. Postpaid. (Shpg. wt. 1 lb. 8 oz.)..... **.713**
9 A 2143—Jacobs No. 6A-33 key-type chuck. Fits arbors with No. 33 Jacobs taper. Capacity 0 to 1/2 inch. Postpaid. (Shpg. wt. 2 lbs. 8 oz.)..... **.760**
- X Jacobs Chuck Arbors.** Precision ground. Extremely accurate.
9 A 2124—To fit 9 A 2142 and 9 A 2143 chucks above. No. 2 Morse taper and No. 33 Jacobs taper. Postpaid. (Shipping weight 14 ounces)..... **.95c**
9 A 2126—To fit 9A2129T, 9A2144 and 9A2991 Jacobs chucks above. No. 2 Morse taper and No. 3 Jacobs taper. Postpaid. (Shipping weight 12 ounces)..... **.95c**
- Jacobs Chuck Keys.** (Not illustrated.) Fit the Jacobs chucks indicated below.
9 A 2054—Jacobs No. 32 key. Fits following Jacobs chucks: Nos. 32, 32B, 32BB, 33, 33B, 33BB, 9, 11, 11N, 381. Postpaid. (Shipping weight 7 oz.)..... **.48c**
9 A 2052—Jacobs No. 3 key. Fits Jacobs chucks: Nos. 3, 3A, 3B, 3AE, 6, 6A-2A, 6A-33, 6B, 6AE, 14, 14N, 34, 34B, 54B, 55B, 56B, 58B, 75A. Postpaid. (Shipping weight 8 ounces)..... **.52c**
9 A 2053—Jacobs No. 4 key. Fits following Jacobs chucks: Nos. 4, 16, 16N, 18, 18N, 36, 36B, 59B. Postpaid. (Shipping weight 12 ounces)..... **.76c**

Arbors and Chucks

- Y Work Arbor.** For mounting drill chucks and holding grinding, buffing and wire scratch wheels, etc. 1/2-in., x20 thread. No. 2 Morse taper shank. Two steel flanges with nut on head end for clamping grinding wheels, etc.
9 A 2152—Shipping weight 11 ounces..... **.95c**
- Z Work Arbor with Chuck.** 3-jaw, screw-on type chuck, tapped 1/2-in., x20-thread. 1/2-inch capacity. No. 2 Morse taper, shank end.
9 A 2247—Shipping weight 1 pound 8 ounces..... **\$1.90**

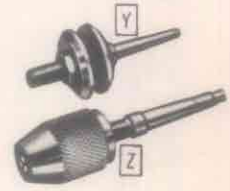

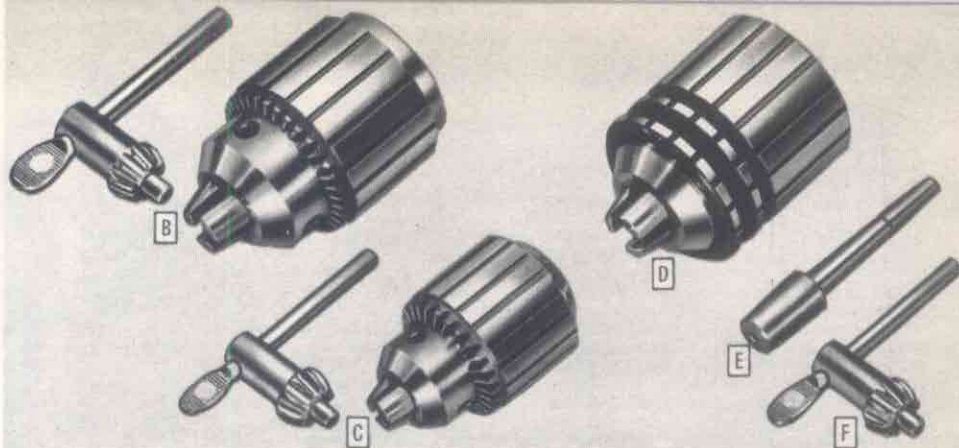

Jacobs Chucks for drill presses, lathes, electric drills, etc.

Genuine Jacobs chucks and arbors, nationally famous for their correct design, excellence of materials and precision manufacture. *All Jacobs chucks and accessories described on this page are postpaid.*

Jacobs Commutator Kit

A For holding armature shafts rigidly during reconditioning. Kit includes: No. 75A armature driving chuck; No. 100 center rest chuck ($\frac{1}{4}$ to $\frac{1}{2}$ -in. capacity); two arbors (No. 2 Morse taper, shank end; No. 3 Jacobs taper head end); chuck key. Comes in metal box. *Postpaid.*
9 A 2129T—(Shpg. wt. 7 lbs. 4 oz.)... **\$21.47**

Jacobs Headstock Chucks

B 9 A 2044—Jacobs No. 55B. Capacity 0 to $1\frac{1}{32}$ in. Fits only 1-in., 8-thread spindle. Cannot be used with any arbor. *Postpaid.* (Shpg. wt. 3 lbs. 10 oz.)... **\$12.59**
9 A 2144—Jacobs No. 58B. Capacity $\frac{1}{8}$ to $\frac{3}{8}$ in. Fits $1\frac{1}{2}$ -in., 8-thread spindle; can be used with No. 3 Jacobs taper arbor. *Postpaid.* (Shpg. wt. 3 lbs. 12 oz.)... **\$15.68**
9 A 2121—Jacobs No. 59B. Capacity $\frac{3}{16}$ to $\frac{1}{2}$ in. Fits $1\frac{1}{2}$ -in., 8-thread spindle. Cannot be used with any type of arbor. *Postpaid.* (Shpg. wt. 5 lbs. 8 oz.)... **\$18.76**

Drill Chucks

C 9 A 2142—Jacobs No. 33 Key-type chuck. Fits arbors with No. 33 Jacobs taper. Capacity $\frac{3}{64}$ to $\frac{1}{2}$ in. *Postpaid.* (Shipping weight 1 lb. 8 oz.)... **\$7.13**
9 A 2143—Jacobs No. 6A-33 key-type chuck. Fits arbors with No. 33 Jacobs taper. Capacity 0 to $\frac{1}{2}$ in. *Postpaid.* (Shipping weight 2 lbs. 8 oz.)... **\$7.60**

Jacobs Chucks for Electric Drills.

9 A 2978—Jacobs No. 1B. Capacity 0 to $\frac{1}{4}$ in. Threaded $\frac{3}{8}$ in. x 24-thread. *Postpaid.* (Shipping weight 8 ounces)... **\$5.23**
9 A 2979—Jacobs No. 7B. Capacity 0 to $\frac{1}{4}$ in. Threaded $\frac{3}{8}$ in. x 24-thread. *Postpaid.* (Shipping weight 10 ounces)... **\$5.23**
9 A 2980—Jacobs No. 33B. Capacity $\frac{3}{64}$ to $\frac{1}{2}$ in. Threaded $\frac{3}{8}$ in. x 20-thread. *Postpaid.* (Shipping weight 1 lb. 3 oz.)... **\$7.13**

Jacobs Center Rest Chuck

D 9 A 2991—Jacobs No. 100CR. Capacity $\frac{1}{4}$ to $\frac{3}{4}$ in. Must be used with No. 3 Jacobs taper arbor to support centerless armatures, etc. *Postpaid.* (Shpg. wt. 3 lbs. 2 oz.)... **\$10.45**

Jacobs Chuck Arbors

Precision ground... extremely accurate to assure finest performance of spindle and chuck.

E For 9A2142 and 9A2143 chucks at left.
9 A 2131—No. 0 Morse and No. 33 Jacobs taper. *Postpaid.* (Shpg. wt. 8 oz.)... **.95c**
9 A 2123—No. 1 Morse and No. 33 Jacobs taper. *Postpaid.* (Shpg. wt. 10 oz.)... **.95c**
9 A 2124—No. 2 Morse and No. 33 Jacobs taper. *Postpaid.* (Shpg. wt. 14 oz.)... **.95c**
For 9A2129, 9A2144 and 9A2991 chucks.
9 A 2133—No. 0 Morse and No. 3 Jacobs taper. *Postpaid.* (Shpg. wt. 10 oz.)... **.95c**
9 A 2154—No. 1 Morse and No. 3 Jacobs taper. *Postpaid.* (Shpg. wt. 12 oz.)... **.95c**
9 A 2126—No. 2 Morse and No. 3 Jacobs taper. *Postpaid.* (Shpg. wt. 12 oz.)... **.95c**

Jacobs Chuck Keys

F 9 A 2051—Jacobs No. 1 key. Fits these Jacobs chucks: Nos. 1, 1A, 1B, 1BB, 1BS. *Postpaid.* (Shpg. wt. 4 oz.)... **.33c**
9 A 2054—Jacobs No. 32 key. Fits following Jacobs chucks: Nos. 32, 32B; 32BB, 33, 33B, 33BB, 9, 11, 11N, 381. *Postpaid.* (Shpg. wt. 7 oz.)... **.48c**
9 A 2052—Jacobs No. 3 key. Fits Jacobs chucks: Nos. 3, 3A, 3B, 3AE, 6, 6A-2A, 6A-33, 6B, 6AE, 14, 14N, 34, 34B, 34VR, 54B, 55B, 56B, 58B, 75A. *Postpaid.* (Shpg. wt. 8 oz.)... **.52c**
9 A 2053—Jacobs No. 4 key. Fits Jacobs chucks: Nos. 4, 16, 16N, 18, 18N, 36B, 59B. *Postpaid.* (Shpg. wt. 12 oz.)... **.76c**
9 A 2073—Jacobs No. 7 key. Fits Jacobs chucks Nos. 7, 7B, 7-1A, 7D, 255, 7BB. *Postpaid.* (Shpg. wt. 7 oz.)... **.38c**

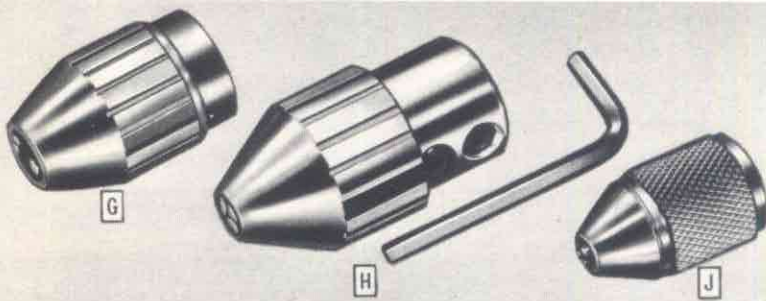

Jacobs Hand Tite Chucks

G 9 A 2175—Jacobs No. 4164. Capacity 0 to $\frac{1}{4}$ in. Tapped $\frac{1}{2}$ in. x 20-thread. *Postpaid.* (Shipping weight 8 ounces)... **\$1.30**
9 A 2145—Jacobs No. 4165. Capacity 0 to $\frac{1}{4}$ inch. Tapped $\frac{1}{2}$ inch x 24 thread. *Postpaid.* (Shipping weight 8 ounces)... **1.30**
9 A 2146—Jacobs No. 4191. Capacity 0 to $\frac{1}{4}$ inch. Tapped $\frac{3}{8}$ inch x 24-thread. *Postpaid.* (Shipping weight 8 ounces)... **1.30**
9 A 2176—Jacobs No. 4364. Capacity 0 to $\frac{3}{8}$ inch. Tapped $\frac{1}{2}$ inch x 20-thread. *Postpaid.* (Shipping weight 1 lb. 2 oz.)... **2.00**
9 A 2147—Jacobs No. 4365. Capacity 0 to $\frac{3}{8}$ inch. Tapped $\frac{1}{2}$ inch x 24-thread. *Postpaid.* (Shipping weight 1 lb. 2 oz.)... **2.00**
9 A 2177—Jacobs No. 4464. Capacity $\frac{1}{8}$ to $\frac{1}{2}$ inch. Tapped $\frac{1}{2}$ inch x 20-thread. *Postpaid.* (Shipping weight 1 lb. 2 oz.)... **2.00**
9 A 2149—Jacobs No. 4465. Capacity $\frac{1}{8}$ to $\frac{1}{2}$ inch. Tapped $\frac{1}{2}$ inch x 24-thread. *Postpaid.* (Shipping weight 1 lb. 2 oz.)... **2.00**

Jacobs Hex Key Chucks

H 9 A 2938—Jacobs No. 6425. Capacity $\frac{1}{8}$ to $\frac{1}{2}$ inch. Bored $\frac{1}{2}$ -inch straight hole. *Postpaid.* (Shipping weight 1 lb. 8 oz.)... **4.00**

SCREW-ON CHUCKS. Most economical type of chuck that tightens by hand. For accurate, but not precise, work. For breast or hand drills, work arbors, polishing heads, grinders and flexible shafts.

HAND-TITE CHUCKS give a tighter grip than screw-on type. For tools listed under screw-on type, where extreme accuracy isn't required.

KEY-TYPE CHUCKS are used on drill presses and electric drills where extreme accuracy is required; for most precise work, and for greatest gripping power.

HEX KEY CHUCKS (with straight hole) are used on many electric tools with flat shafts. Hex key chucks will also work directly on electric motor shafts. For accurate work.

ARBORS will make tools adaptable to other accessories such as grinding wheels, chucks, polishing wheels, etc. Two types: (1) Straight hole for motors and unthreaded spindle power tools. (2) Taper type for lathes with taper spindles.

CENTERS are used to hold work being machined in lathes. They vary in size and according to: headstock or tailstock use; type of material being worked; speed of operation.

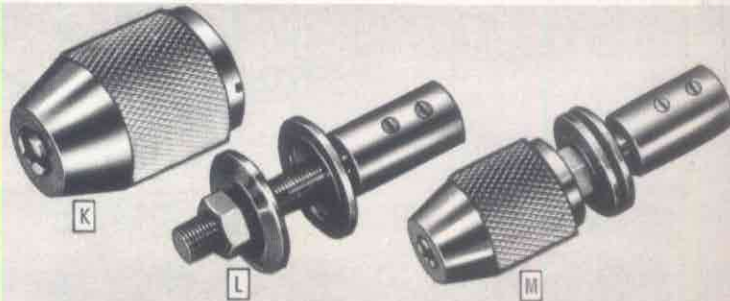

CRIFTSMAN 3-jaw Chucks . . . screw-on type

J Tapped to fit $\frac{1}{2}$ -inch x 20-thread spindles. Check spindle size.
9 A 2248— $\frac{1}{4}$ -inch capacity. Shipping weight 5 ounces... **.70c**
9 A 2243— $\frac{3}{8}$ -inch capacity. Shipping weight 12 ounces... **.80c**
K 9 A 2256— $\frac{1}{2}$ -inch capacity. Shipping weight 12 ounces... **.98c**

CRIFTSMAN General-purpose Work Arbor

L Converts your motor into a grinder, polisher, buffer, etc. Of carbon steel. 4 inches long. $2\frac{3}{8}$ -inch spindle has $\frac{1}{4}$ -inch x 20 thread. Steel flanges for clamping grinding or buffing wheels. Fits $\frac{1}{2}$ or $\frac{3}{8}$ -inch unthreaded shaft. Fastens with 2 set screws. *State whether for $\frac{1}{2}$ or $\frac{3}{8}$ -in. spindle.*
9 A 2164—Shipping weight 12 ounces... **.75c**

Arbor with 3-jaw, $\frac{1}{2}$ -inch Drill Chuck

M Chuck and $\frac{1}{2}$ -inch x 20-thread arbor with steel flanges. Fits $\frac{1}{2}$ or $\frac{3}{8}$ -inch unthreaded straight spindle. Fastens with 2 set screws. *State whether for $\frac{1}{2}$ or $\frac{3}{8}$ -inch spindle.*
9 A 2151—Shipping weight 1 pound 10 ounces... **\$1.50**

CRAFTSMAN quality Lathe Chucks

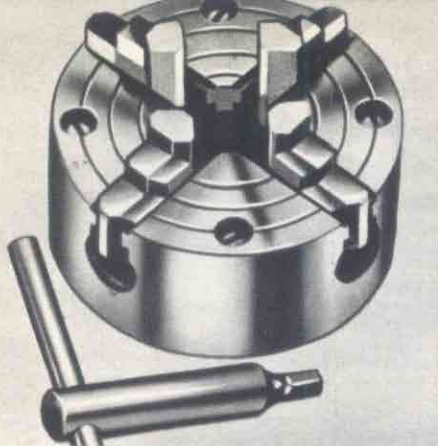

4-jaw Independent

CRAFTSMAN. Precision made of finest materials. Body of special alloy steel has deep, wide jaw slots for added strength and greater bearing surface. For average shop needs.

Four reversible jaws, drop forged from a solid bar of special steel, work independently; especially useful for holding irregular shaped pieces. Large diameter jaw screw for extra strength; Acme threaded.

T-handle chuck wrench included. Fit any lathe with spindle diameters and threads per inch listed below. Sizes to fit 5 different threaded lathe spindles.

9 A 2137—CRAFTSMAN. Fits $\frac{1}{2}$ -inch x 24-thread spindle. Diameter 3 inches. Shipping weight 2 pounds 8 ounces. **\$6.95**

9 A 2157—CRAFTSMAN. Fits $\frac{1}{2}$ -inch x 20-thread spindle. Diameter 3 inches. Shipping weight 2 pounds 8 ounces. **\$6.95**

9 A 2156—CRAFTSMAN. Fits $\frac{3}{4}$ -inch x 16 thread spindle. Diameter 4 inches. Shipping weight 3 pounds 10 ounces. **\$7.95**

9 A 2138—CRAFTSMAN. Fits 1-inch x 8-thread spindle. Diameter 4 inches. Shipping weight 3 pounds 12 ounces. **\$7.95**

9 A 2139—CRAFTSMAN. Fits $1\frac{1}{2}$ -inch by 8-thread spindle. Diameter 6 inches. Shipping weight 9 pounds 10 ounces. **\$14.95**

9 A 02141—CRAFTSMAN. Fits $1\frac{1}{2}$ -inch by 8-thread spindle. Diameter 8 inches. Shipping weight 25 pounds. **\$26.95**

3-jaw Universal Chuck

For precise, heavy-duty work

CRAFTSMAN finest quality . . . true precision construction . . . best materials and craftsmanship. 3-jaw self-centering type. Jaws are controlled by single screw and pinion gear. Ideal for production work because of their great accuracy, leverage and holding power.

Chuck body casting of high-strength semi-steel construction. Special alloy metal scroll and alloy steel pinion. Alloy steel jaws are heat treated and hardened; have raised, precision-ground steps. Accurate within standard chuck tolerances which is approximately .003 inches. Complete with two sets of jaws; one for outside and one for inside gripping. T-handle chuck wrench included. Fit lathes with spindle diameters and threadings listed below.

9 A 2148—Fits 1-inch by 8-thread spindle. Diameter 4 inches. Shpg. wt. 5 lbs. 2 oz. **\$35.00**

9 A 2150—Fits $1\frac{1}{2}$ -inch by 8-thread spindle. Diameter 5 inches. Shpg. wt. 7 lbs. 14 oz. **\$36.50**

3-jaw Universal Chuck

Low priced . . . for medium duty

CRAFTSMAN fine quality in design, materials and construction. Self-centering, lever-operated type . . . has only two main parts, body and scroll. Ideal for production work because of speedy gripping. Accurate within standard chuck tolerances which is approximately .003 inches.

Case-hardened, cold rolled steel jaws; polished steel body and scroll. Knurled rim permits easy hand operation. Body casting is precision threaded to fit directly on spindle. Has two sets of jaws; one for outside and one for inside gripping. Chuck wrench included. In four sizes. Fit lathes with spindle diameters and threadings listed below.

9 A 2296—CRAFTSMAN. Fits $\frac{1}{2}$ -in. by 20-thread spindle. Diam. 3 in. Shpg. wt. 3 lbs. 5 oz. **\$17.75**

9 A 2297—CRAFTSMAN. Fits 1-in. by 8-thread spindle. Diam. 4 in. Shpg. wt. 6 lbs. 5 oz. **\$21.50**

9 A 2298—CRAFTSMAN. Fits $1\frac{1}{2}$ -in. by 8-thread spindle. Diameter 5 in. Shpg. wt. 10 lbs. **\$25.50**

9 A 02299—CRAFTSMAN. Fits $1\frac{1}{2}$ -in. by 8-thread spindle. Diam. 6 in. Shpg. wt. 15 lbs. **\$32.50**

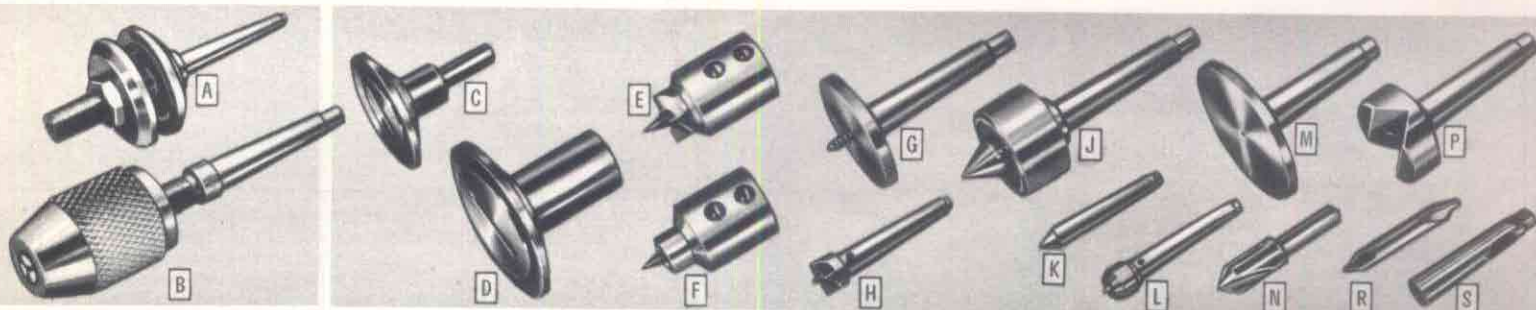
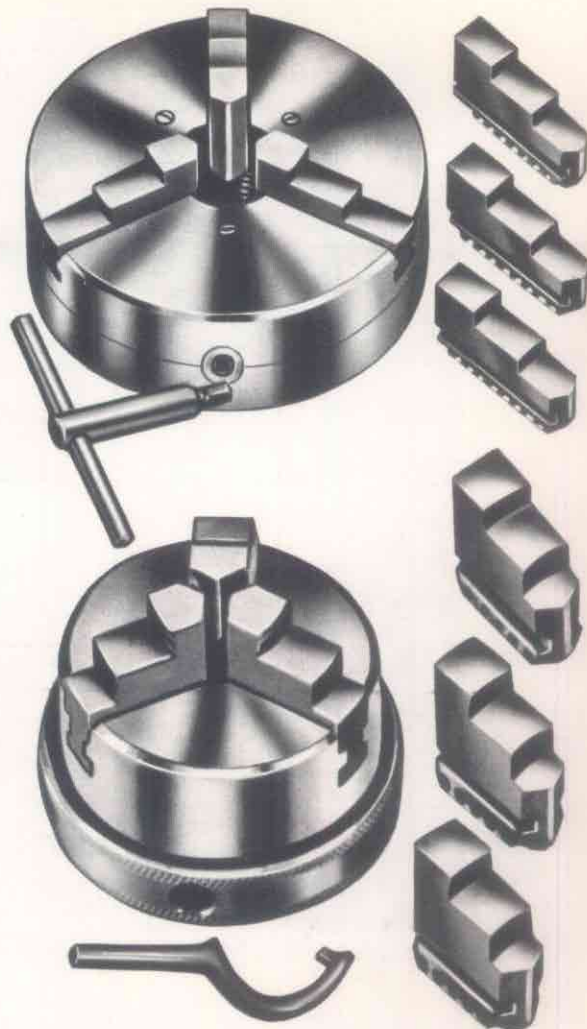

Arbors and Chucks

A Work Arbors. For mounting drill chucks and holding grinding, buffing and wire scratch wheels, etc. $\frac{1}{2}$ -inch x 20-thread. Morse taper shank. 2 steel flanges with nut on head end for clamping wheels.

9 A 2117—No. 0 Morse taper. Shpg. wt. 8 oz. **95c**
9 A 2153—No. 1 Morse taper. Shpg. wt. 9 oz. **95c**
9 A 2152—No. 2 Morse taper. Shpg. wt. 11 oz. **95c**

B Work Arbors with Chucks. 3-jaw, screw-on type chucks, $\frac{1}{2}$ -inch capacity; tapped $\frac{1}{2}$ inch x 20-thread. Have Morse taper on shank end.

9 A 2276—No. 0 Morse taper with chuck and arbor. Shipping weight 1 lb. 4 oz. **\$1.90**
9 A 2234—No. 1 Morse taper with chuck and arbor. Shipping weight 1 lb. 8 oz. **\$1.85**
9 A 2247—No. 2 Morse taper with chuck and arbor. Shipping weight 1 lb. 8 oz. **\$1.90**

Abrasive Disc Holders

A handy accessory for converting your lathe, drill press, hand drill, electric drill, etc. into a sander or polisher. For use with abrasive discs, etc.

C 9 A 2446— $1\frac{1}{2}$ -inch diameter. Has $\frac{1}{4}$ -inch straight shank. Shpg. wt. 5 oz. **63c**
D 9 A 2447—2-inch diameter. Tapped for use on any $\frac{1}{2}$ -inch x 20-thread spindle. Shpg. wt. 7 oz. **90c**

Use Sears Easy Payment Plan to equip your shop completely, NOW. See inside front cover for details

CRAFTSMAN fine quality Lathe Centers and Accessories

Lathe Centers. (E) (F) Ideal for use on any lathe with $\frac{1}{8}$ -inch straight spindle. Fasten with 2 set screws. Precision made, ground and polished steel. Especially designed for maximum strength and rigidity. Replaceable center points.

E 9 A 2105—Headstock Spur Center. For driving work mounted between centers. Shpg. wt. 6 oz. **95c**
F 9 A 2102—Tailstock Cup Center. Supports work in tailstock. Shpg. wt. 6 oz. **95c**

G Screw Centers. For facing and hollowing operations. Replaceable center. Morse taper shank sizes as listed below.

9 A 2116—No. 1 Morse taper. Shpg. wt. 12 oz. **\$1.45**
9 A 2115—No. 2 Morse taper. Shpg. wt. 14 oz. **\$1.45**

H Spur Centers. Use for wood turning. Accurately ground for perfect fit. Morse taper shank.

9 A 2108—No. 0 Morse taper. Shpg. wt. 3 oz. **75c**
9 A 2106—No. 1 Morse taper. Shpg. wt. 4 oz. **85c**
9 A 2107—No. 2 Morse taper. Shpg. wt. 7 oz. **87c**

J Precision ball bearing 60-degree center. For Hard wood or metal. (Center point rotates on ball bearing.) Recommended for high speed operations. Morse taper shank as listed below.

9 A 2112—No. 1 Morse taper. Shpg. wt. 8 oz. **\$2.90**
9 A 2113—No. 2 Morse taper. Shpg. wt. 8 oz. **2.90**

K 60-degree Centers. Use for turning hard woods and metals. Choice of three Morse taper shanks as listed below.

9 A 2103—No. 0 Morse taper. Shpg. wt. 3 oz. **65c**
9 A 2110—No. 1 Morse taper. Shpg. wt. 3 oz. **70c**
9 A 2111—No. 2 Morse taper. Shpg. wt. 7 oz. **75c**

L Tailstock Cup Centers. Support work in tailstock. Morse taper shank as listed below.

9 A 2109—No. 0 Morse taper. Shpg. wt. 3 oz. **70c**
9 A 2100—No. 1 Morse taper. Shpg. wt. 3 oz. **75c**
9 A 2101—No. 2 Morse taper. Shpg. wt. 7 oz. **87c**

M 9 A 2187—Drill Pad. Used in tailstock as rigid support for drilling flat or square work. Diameter of face, $3\frac{1}{2}$ in. Steel shank has No. 2 Morse taper. Shpg. wt. 1 lb. 2 oz. **\$1.45**

N 9 A 6697—82° Center Reamer. $\frac{3}{8}$ -inch size. $\frac{1}{4}$ -inch shank diameter. Shpg. wt. 1 oz. **\$1.15**

P 9 A 2114—Crotch Center. Automatically centers round work in tailstock for accurate cross-drilling. V-slot is precision machined. Steel shank has No. 2 Morse taper. Shpg. wt. 1 lb. **\$1.45**

R 9 A 2061—Center Drill. Combination drill and countersink. In $\frac{3}{32}$ or $\frac{1}{16}$ -inch size. *State size wanted.* Shipping weight 1 ounce. **45c**

S 9 A 2161—Adapter Sleeve. To reduce from No. 2 to No. 1 Morse Taper. Shpg. wt. 5 oz. **\$1.30**

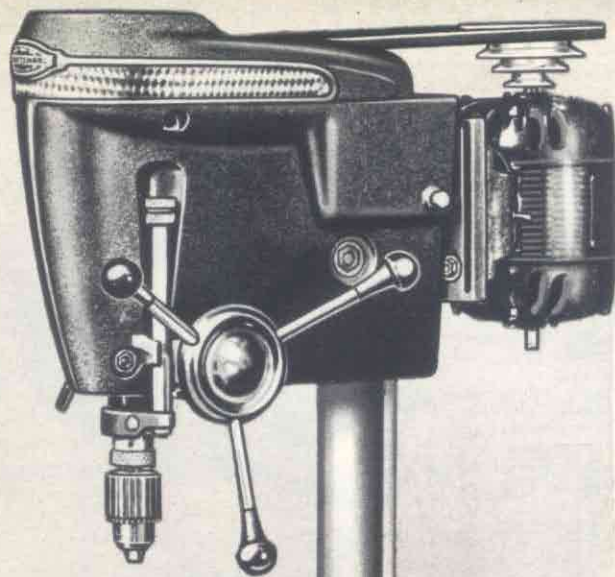

CRAFTSMAN
 THE RIGHT WAY
 TO SAY
**HARDWARE
 AND TOOLS**



A
 Without motor
\$82.50 CASH
\$8.50 DOWN ON TERMS
 \$107.45 with motor

B
 Without motor
\$72.50 CASH
\$7.50 DOWN ON TERMS
 \$97.45 with motor



CRAFTSMAN "100" Drill Presses

Ball bearing industrial type

Drill to center of 15-inch circle. By far our finest drill presses! Extra heavy duty! Meet the most rigid demands of professional craftsmen and industrial shops. Notice the modern designed streamlined head... no unsightly spindle extending above head. Famous "Floating Drive" spindle assembly eliminates side pull of belt and pulley "whip". Spindle "floats" within pulley! Four sets heavy duty, shielded precision ball bearings are used! Easy-acting three-lever feed handle.

Jacobs No. 6A-33 chuck... 0 to 1/2-inch capacity. Improved spiral coil spring quill return. Rubber cushion absorbs quill return shock; preloads quill bearings to take up wear and reduce spindle end play after long use. Positive-acting quill lock permits you to do routing, shaping and mortising using proper attachments. (Attachments not included; see pages 28 and 29.) Depth gauge graduated in 16ths of an inch. Accurate stop collar may be set for repetitive drilling.

10x10-in. ground cast semi-steel table tilts 0 to 90° right or left... slotted to hold fixtures. Taper pin maintains table in perfect alignment at horizontal (90°) position. Base has 10x10-in. working surface; slotted for attachments.

SPECIFICATIONS:	A 99 AM 2314	B 99 AM 2313
• Depth of throat.....	7 3/4 inch	7 3/4 inch
• Spindle.....	No. 33 Jacobs taper	No. 33 Jacobs taper
• Bearings.....	4 sets precision ball	4 sets precision ball
• Chuck capacity (Jacobs 6A-33)...	0 to 1/2 inch	0 to 1/2 inch
• Spindle travel.....	4 inches	4 inches
• Depth gauge, graduations.....	1/16 of an inch	1/16 of an inch
• Column diameter (outside).....	2 3/4 inches	2 3/4 inches
• Table size.....	10x10 inches	10x10 inches
• Table travel.....	41 1/2 inches	13 3/2 inches
• Distance table to chuck, max....	41 1/2 inches	13 3/2 inches
• Distance base to chuck, max....	45 3/4 inches	17 3/4 inches
• Machine and motor pulleys (included).....	5-in. 4-step	5-in. 4-step
• Motor recommended, minimum..	1/2-H.P. 1750 R.P.M.	1/2-H.P. 1750 R.P.M.
• 11 speeds from.....	625 to 5000 R.P.M.	625 to 5000 R.P.M.
• Mounting dimensions.....	16 1/4 x 14 1/2 inches	9 3/4 x 14 3/4 inches
• Overall dimensions: Height.....	68 3/4 inches	36 3/4 inches
Width.....	18 1/4 inches	12 3/4 inches
Depth.....	24 inches	19 inches

- A** 99 AM 2314—Floor model without motor. Shpg. wt. 181 lbs. **\$82.50**
- 99 AM 2331—Floor model with 1/2-H.P. 1750 R.P.M. capacitor ball bearing, 110-120-volt 60-cycle A.C. motor. Shipping weight 215 pounds. **107.45**
- B** 99 AM 2313—Bench model without motor. Shipping weight 136 lbs. **72.50**
- 99 AM 2330—Bench model with 1/2-H.P. 1750 R.P.M. capacitor ball bearing 110-120-volt 60-cycle A.C. motor. Shipping weight 170 pounds. **97.45**

CRAFTSMAN Production Table

For use with oil or coolants. 19x18 3/4 x 4 in. Cast semi-steel; 10 1/2 x 16 1/2 in. ground surface. Oil trough surrounds table; 3/4 in. x 18-thread outlet. Column bore 2 3/4 in. Fits drill presses 99AM2314, 99AM2331, 99AM2313, 99AM2330. With Allen wrench for cap screws. Shipped freight or express from factory in Ypsilanti, Mich., from where you pay shipping charges on delivery. 99 A 2306F—Shpg. wt. 50 lbs. **\$19.95**

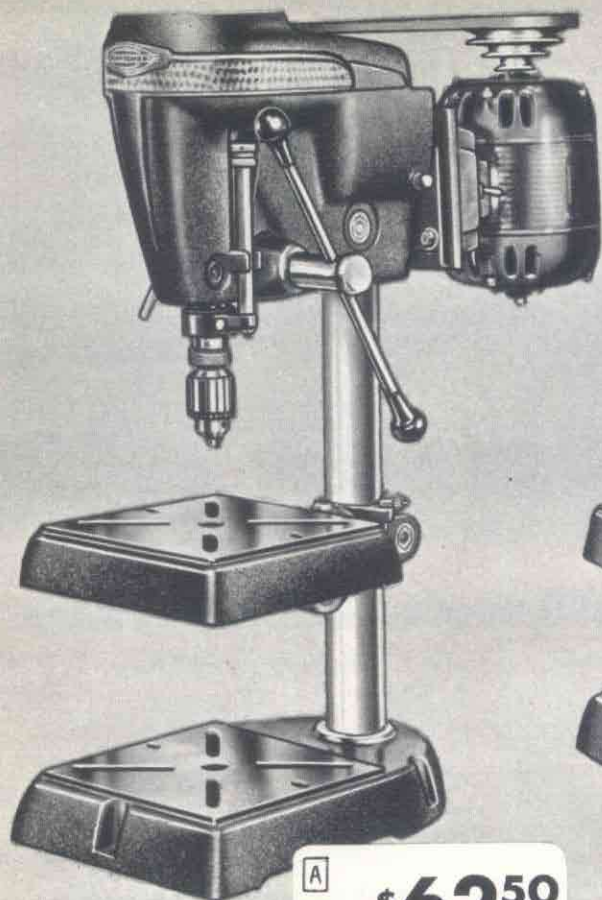

A
Without motor
\$62.50 CASH
\$6.50 DOWN ON TERMS
\$87.45 with motor



B
Without motor
\$39.50 CASH
\$4.00 DOWN ON TERMS
\$56.00 with motor



C
Without motor
\$14.50
\$27.50 with motor

CRAFTSMAN "80" and DUNLAP Drill Presses

Ball bearing Drill Press

A CRAFTSMAN "80". Professional quality. Heavy duty type for wood and metal. No 6A-33 Jacobs key chuck; 0 to 1/2-inch capacity; with key. Four sets heavy duty, shielded precision ball bearings and "Floating Drive" spindle assembly assure smooth operation.

Drills to center of 13 1/2-inch circle. Improved spiral coil spring quill return. Rubber cushion absorbs quill return shock and preloads quill bearings. Adjustable stop collar for repetitive drilling. Depth gauge graduated in 16ths. 2 1/4-in. diameter column.

Perfectly aligned table. Tapered pin holds table on support in alignment at horizontal position. Table can be tilted 0 to 90 degrees right or left. Table and base both cast semi-steel; slotted for attachments.

SPECIFICATIONS:

- Depth of throat..... 6 3/4 inches
- Spindle..... No. 33 Jacobs taper
- Bearings..... 4 sets precision ball
- Chuck capacity..... 0 to 1/2 inch
- Spindle travel..... 3 1/2 inches
- Depth gauge graduations..... 1/16 inch
- Outside column diameter..... 2 1/4 inches
- Table size..... 9x9 inches
- Table travel..... 10 5/16 inches
- Table to chuck, maximum..... 10 5/16 inches
- Base size..... 11x16 3/4 inches
- Base to chuck, maximum..... 14 3/8 inches
- Machine and motor pulley (included)..... 5-in. 4-step
- Motor recommended, minimum..... 1/2 HP. 1750 R.P.M.
- Eleven speeds..... 625 to 5000 R.P.M.
- Mounting dimensions..... 8 3/8 x 12 1/2 inches
- Over-all dimensions: Height 31 3/8 inches; width 11 3/4 inches; depth 16 3/8 inches.

99 AM 2364—Without motor. Shpg. wt. 108 lbs... **\$62.50**
 99 AM 2366—With 1/2-H.P. 1750 R.P.M. capacitor 110-120-volt 60-cycle A.C. ball bearing motor. Shipping weight 143 pounds... **\$87.45**

Bronze bearing Drill Press

B DUNLAP. A good quality drill press... ideal for drilling operations in smaller shops. Accurate... smooth running... does efficient work in either wood or metal.

Drills to center of 12 1/4-inch circle. Runs on three long-life, self-lubricating porous bronze bearings; ball thrust bearing absorbs spindle thrust. Famous "Floating Drive" spindle assembly eliminates side pull of belt and pulley "whip"; helps give smoother operation.

Has No. 33 Jacobs key chuck (1/4 to 1/2-inch capacity) with key. No. 33 Jacobs taper spindle. Adjustable stop collar for repetitive drilling. Depth gauge accurately graduated in 16ths of an inch. Improved spiral coil spring quill return; rubber cushion absorbs return shock.

Smooth ground cast semi-steel table. 7 3/4 x 7 3/4-inch working surface on both table and base. Both table and base slotted for attachments. Table does not tilt.

SPECIFICATIONS:

- Depth of throat..... 6 1/2 inches
- Spindle..... No. 33 Jacobs taper
- Bearings..... 1 ball thrust; 3 porous bronze
- Chuck capacity..... 1/4 to 1/2 in.
- Spindle travel..... 3 inches
- Outside diameter of column..... 1 3/4 inches
- Table size..... 7 3/4 x 7 3/4 inches
- Table travel..... 8 3/8 inches
- Table to chuck, maximum..... 8 3/8 inches
- Base size..... 9x14 inches
- Base to chuck, maximum..... 11 3/8 inches
- Machine and motor pulley (included)..... 4-inch 4-step
- Motor recommended, minimum..... 1/2-H.P. 1750 R.P.M.
- Eleven speeds..... 750 to 4000 R.P.M.
- Mounting dimensions..... 7 7/8 x 11 1/16 inches
- Overall dimensions: Height 26 3/8 inches; width 10 3/4 inches; depth 15 1/2 inches.

99 AM 2362—Without motor. Shpg. wt. 79 lbs... **\$39.50**
 99 AM 2363—With 1/2-H.P. 1750 R.P.M. ball bearing split phase motor for 110-120-volt 60-cycle A.C. Shipping weight 106 pounds... **\$56.00**

Low priced Drill Press

C DUNLAP. A good, economy-priced drill press for your hobby or small home workshop. For drilling wood or metal.

Drills to center of 9-inch circle. Two top quality self-lubricating porous bronze bearings; one ball thrust bearing.

Adjustable head, table and idler drive. Screw-on type chuck; 3/8-inch capacity. Ground steel column. Smooth ground table, 3/4 x 56-inch V-belt included.

SPECIFICATIONS:

- Depth of throat..... 4 1/2 inches
- Spindle..... 3/8-20 thread
- Bearings..... 2 porous bronze; 1 ball thrust
- Chuck capacity..... 0 to 3/8 inch
- Spindle travel..... 1 11/16 inches
- Outside column diameter..... 1 3/8 inches
- Table size..... 5 1/4 x 5 1/4 inches
- Table travel..... 10 1/16 inches
- Table to chuck, maximum..... 10 1/16 inches
- Base size..... 6x6 inches
- Base to chuck, maximum..... 11 3/8 inches
- Machine pulley (included)..... 3-inch 3-step for 3/4-in. "V" Belt
- Motor pulley (not included), 3-inch 3-step
- Motor recommended, minimum 1/2-H.P. 1750 R.P.M.
- Belt (included)..... 3/4 x 56 inches
- Seven speeds..... 1150 to 3450 R.P.M.
- Mounting dimensions..... 8x6 3/4 inches
- Overall dimensions: Height 24 7/8 inches; depth 13 3/4 inches; width 7 1/4 inches.

99 A 02172—Without motor. Shipping weight 26 pounds... **\$14.50**
 99 AT 2188—With 1/2 H.P. 1750 R.P.M. split phase, bronze bearing 110-120-volt 60-cycle A.C. motor and 3-step cone type motor pulley. Shipping weight 53 pounds... **\$27.50**

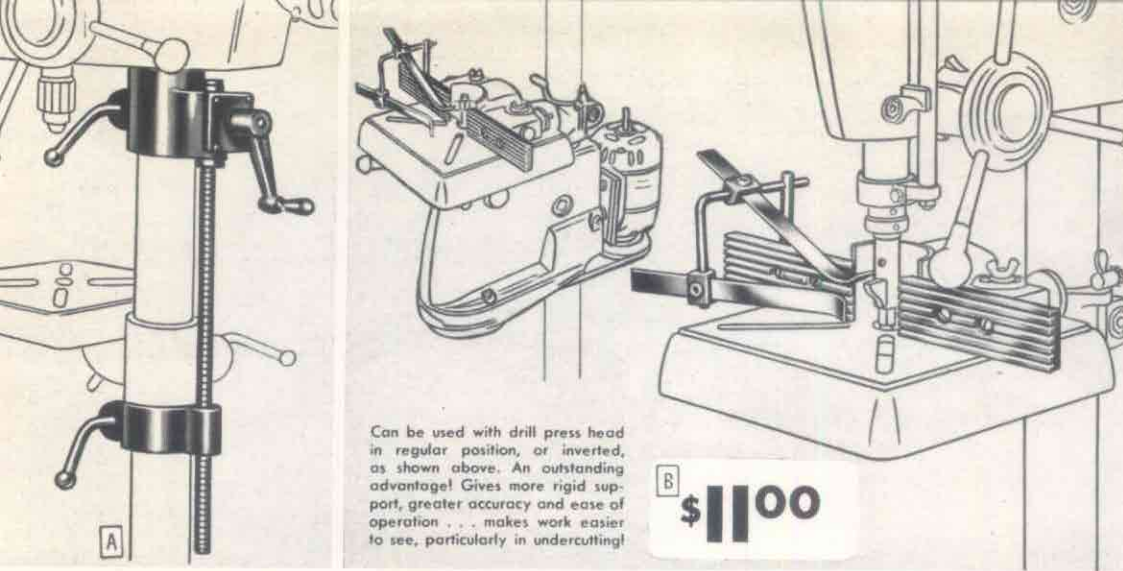

Can be used with drill press head in regular position, or inverted, as shown above. An outstanding advantage! Gives more rigid support, greater accuracy and ease of operation . . . makes work easier to see, particularly in undercutting!

\$11.00

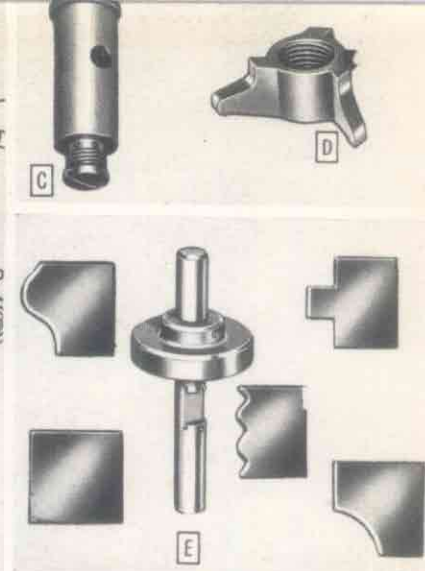

Fine quality, precision-made Drill Press Accessories . . .

Head and Table Lift

A For CRAFTSMAN 99AM2314 and many other floor model drill presses with 2 3/4-inch outside diameter columns. For fast, easy raising or lowering of drill press head or table. Support collars for drill head and table are positioned by Acme-threaded lift screw with bevel-gear drive controlled by handy crank handle. Both support collars have co-ordinate clamp locks. When head support collar is tightened, lower collar may be loosened for raising or lowering table. Similarly, when table collar is tightened, it serves as support for positioning drill press head.

Each turn of crank gives 1/8-inch travel. Maximum travel at any one setting is 12 inches. Two bevel gears, thrust bearing and crankshaft are all housed in gear case which is cast in one piece with the upper support collar for extra strength. Ball thrust bearing absorbs the load on the screw.

99 A 02419—Shpg. wt. 30 lbs. **\$18.50**

CRAFTSMAN Shaper Fence Attachment

B New! Makes your drill press more useful for making picture frame, sash and many types of molding and trim. The answer to the home craftsman who has limited use for a separate shaper. Fits drill presses 99 AM 2314, 99 AM 2313, 99 AM 2364 and 99 AM 2362 on pages 26 and 27 or most any other drill press. Unit fastens to drill press table with fast-acting wing nuts. Once installed, it can be left undisturbed during all operation adjustments. Fence faces of hardwood, each 6 3/4 x 2 1/4 in., have separate finger-tip, micrometer-type adjustments with 1 1/8-in. maximum forward and back travel; and open from 1-in. for smallest diameter shaper cutter to 3-in. maximum for large cutters or sanding drum work; lock separately for accuracy. Fence faces are planed to within .005-in. accuracy after assembling of unit. One-piece cast aluminum has opening in back for chip outlet. Cutter enclosed for maximum safety. Adjustable steel hold-downs for constant pressure on work, have easier action "one-screw" locks. Entire hold-down assembly shifts quickly, to either end of unit for regular or reverse feeding. Use with cutters and attachments on opposite page.

9 A 2487—Shipping weight 5 pounds. **\$11.00**

Adapters and Cutters

C Adapter for 9 A 2438 sash cutter below. Fits spindles of drill presses 99AM2314, 99AM2313, 99 AM 2364 and 99 AM 2362, (see pages 26 and 27), or any drill press with No. 33 Jacobs taper spindle and threaded locking collar to hold adapter flange securely.

9 A 2437—Shipping weight 7 ounces. **\$1.35**

D Sash Cutter. For 9 A 2437 above.

9 A 2438—Shipping weight 4 ounces. **\$2.29**

CRAFTSMAN Drill Press Shaper Set

E New! Economical! Converts your drill press into an efficient shaper at very little extra expense. Shapes almost any contour you wish, including tongue-and-groove. Attachment is 4 1/2-in. high, with 1/2 x 4 1/2-in. spindle. Operates at 5000 R.P.M.; has blade guard for safety. With 5 assorted tool steel cutter blades, 3/8-in. wide, and Allen wrench. Should be used with 1/2-in. collet chuck on any drill press (see opposite page).

9 A 2486—Shipping weight 8 oz. Set **\$2.85**

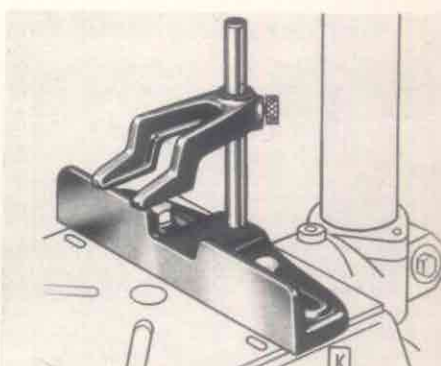
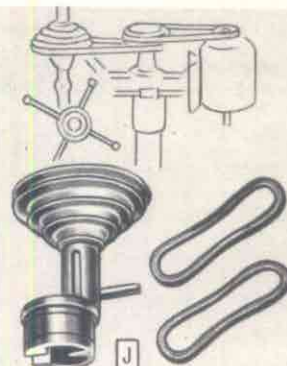
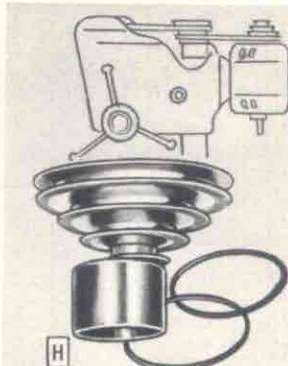
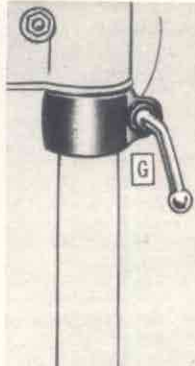
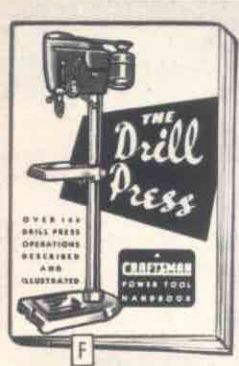

Drill Press Instruction Book

F New; up-to-date! 32 pages covering over 100 drill press operations. Over 175 illustrations. Explains how to do drilling, shaping, sanding, mortising, dovetailing, routing and carving. Describes new uses and accessories for your drill press. Paper bound.

9 A 2921—Shipping weight 2 oz. **35c**

Drill Press Collars

Locks on column under drill press head or table. Makes it easy to swing head or table around for working at different positions. Makes your drill press work much easier to handle.

G 9 A 2429—For drill presses on page 26, or any drill press with a 2 3/4-in. outside diameter column. Shpg. wt. 2 lbs. **\$1.85**

9 A 2427—For 99 AM 2364 and 99 AM 2366 drill presses on page 27, or any drill press with a 2 1/4-in. outside diameter column.

Shipping weight 2 pounds 8 ounces. **\$1.85**

CRAFTSMAN Multi-Speed Attachments

Permits you to use the correct speed for every drill press job. The right speed means better performance and smoother cutting. Enables you to get the most out of your drill press. Gives you 20 speeds from 200 R.P.M. to about 15,000 R.P.M. 8 speeds are under 1,000 R.P.M., a complete range for the low speeds required for metal drilling even with 3/8-inch drills. The remaining speeds offer correct, most efficient speed for wood drilling, shaping, routing, carving, dovetailing, etc.

Finest ball bearing construction. Balanced 4-step, cone-type pulley. 2 V-belts included. We recommend the use of 3/4-H.P. 1750 R.P.M. motor (minimum) to secure sufficient power for high speed work.

H Fits 99 AM 2314, 99 AM 2313 and 99 AM 2364 (see pages 26 and 27), and some other drill presses with 2 or 2 3/8-inch (plus .005-inch) inside diameter column.

9 A 2338—Shpg. wt. 5 lbs. **\$10.25**

(Not illustrated.) Fits former drill presses 2482, 2483, and some others with 2 3/8-inch (plus .005-inch) inside diameter columns.

9 A 2399—Shpg. wt. 5 lbs. **\$10.25**

J Fits former drill presses 2407, 2392, 2423, and some other drill presses with 2 3/4-inch (plus .005-inch) inside diameter columns.

9 A 2394—Shpg. wt. 5 lbs. **\$10.25**

(Not illustrated.) Fits former drill presses 2380 and some other drill presses with 2-inch (plus .005-inch) inside diameter column.

9 A 2397—Shpg. wt. 5 lbs. **\$10.25**

Hold-down and Guide

K CRAFTSMAN. Made to fit almost any drill press table. An indispensable aid in mortising, routing, planing or repetitive drilling. Fingers on the hold-down prevent work from being lifted when chisel or drill is raised. It is easily and quickly adjustable for thick or thin materials. Fence keeps work lined up accurately. Attachment bolts to your drill press table; may be adjusted forward or backward simply by loosening bolts. Fence section can also be used without the hold-down to serve as a guide in routing, inlay work, repetitive drilling and similar operations. Durable heavy cast iron construction assures accurate operation. Grey enamel finish. Shipping weight 6 pounds 6 ounces.

9 A 2457. **\$4.00**

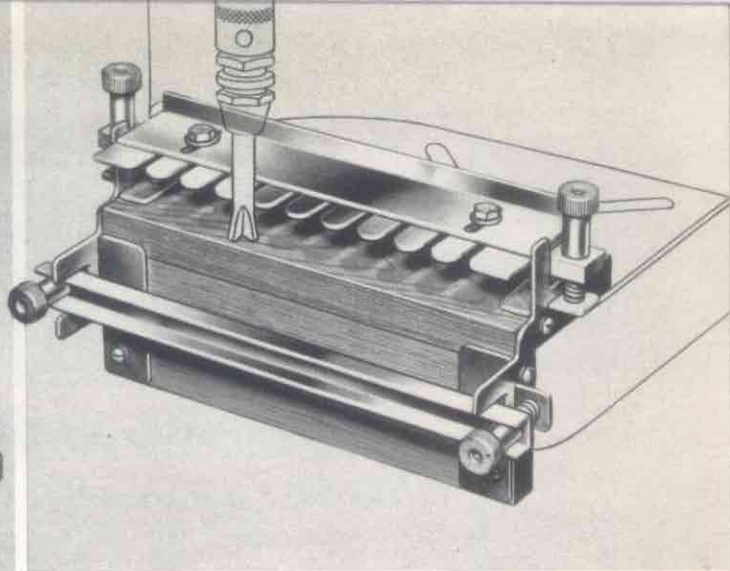
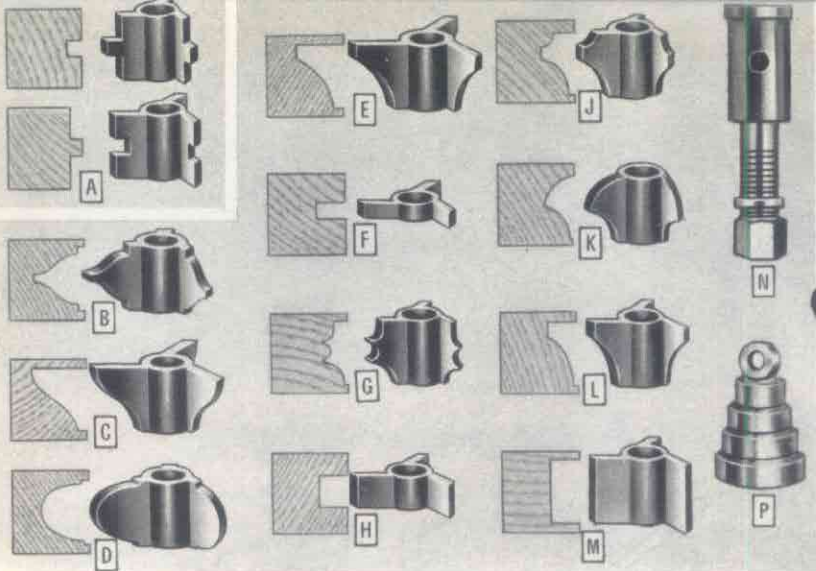

make your drill press a much more useful shop tool!

Shaper Cutters for drill press or shaper

Of finest quality, hardened alloy steel, precision machined. Keen, long lasting edges, ground to exact dimensions. Cutters have 1/8-in. bore. Use with adapter 9 A 2435 below, when used on drill press with Jacobs taper. Sharpen by grinding front face only on flat, fine grit wheel.

- A** A complete matched set of tongue and groove cutters to be used in connection with your drill press or shaper. Precision ground and matched for accurate fit. 1/8-inch bore; 1-inch high; 3/8-inch radius. 9 A 2365—Shpg. wt. 10 oz. Set **\$3.75**
- B** 9 A 2345—Large size cutter. 1-in. high; 1 1/4-in. radius. Shpg. wt. 8 oz. Each **\$2.75**
- C** 9 A 2347—Large size cutter. 1-in. high; 1 1/4-in. radius. Shpg. wt. 8 oz. Each **\$2.75**
- D** 9 A 2346—Large size cutter. 1-inch high; 1 1/4-in. radius. Shpg. wt. 8 oz. Each **\$2.75**
- E** 9 A 2348—Large size cutter. 1-inch high; 1 1/4-in. radius. Shpg. wt. 8 oz. Each **\$2.75**
- F** 9 A 2319—1/2-in. high; 3/8-in. radius. Shipping weight 6 ounces. Each **\$1.35**
- G** 9 A 2327—1-in. high; 7/8-in. radius. Shipping weight 6 ounces. Each **\$1.90**
- H** 9 A 2321—1/2-in. high; 3/8-in. radius. Shipping weight 6 ounces. Each **\$1.60**
- J** 9 A 2329—1-in. high; 7/8-in. radius. Shipping weight 6 ounces. Each **\$1.90**

- K** 9 A 2335—1-in. high; 3/8-in. radius. Shipping weight 6 ounces. Each **\$1.90**
- L** 9 A 2323—1-in. high; 3/8-in. radius. Shipping weight 6 ounces. Each **\$1.90**
- M** 9 A 2333—1-in. high; 3/8-in. radius. Shipping weight 6 ounces. Each **\$1.85**
- N** Adapter for all 1/2-inch bore shaper cutters shown at left and above. Fits spindles of CRAFTSMAN drill presses 9 A 2314 and 9 A 2313, 9 A 2362 and 9 A 2364, (pages 26 and 27), or any drill press with No. 33 Jacobs tapered spindle and knurled locking collar. 9 A 2435—Shipping weight 7 oz. **\$1.30**
- P** Shaper Collars. Mount beneath shaper cutters to control depth of cut on curved work. Fit 1/2-inch spindle. Set of 5. 9 A 2367—Shipping wt. 6 oz. Set **\$1.85**

Dovetailing Attachment

Makes perfect dovetail joints, as on desk and dresser drawers. Both pieces are cut at same time. Pieces to be dovetailed are held at right-angles in clamp, and cutter is guided through one piece into the other. Complete with hardened steel spacing comb, to guide shank of router to predetermined depth; end plates; screw fittings and clamps for holding work; wood parts; and complete instructions. Dovetail cutter bit not included. Use 9 A 2411 listed below. 9 A 2462—Shipping weight 4 pounds 1 ounce. **\$8.00**

Woodworking Cutters

For drill-press carving, round-end mortising, dovetailing, boring, round edging, reeding and general routing. Precision made of finest quality high speed steel. Keen edges, perfectly ground to exact dimensions. All have 1/8-inch shanks. Use with either 9 A 2455 or 9 A 2271 collet chucks shown below. Routing bits are used most efficiently when work is held against a fence to obtain parallel and accurate routing (see 9 A 2457 Hold-down Guide at bottom of opposite page). **Caution: Use these cutters in collet chucks only—NEVER in Jacobs or other three jaw drill chucks!** Shpg. wt. each 6 oz.

- (W) 9 A 2400—1/8-inch router. **\$1.20**
- (X) 9 A 2401—1/8-inch router. 1.30
- (Y) 9 A 2402—1/8-inch router. 1.35
- (Z) 9 A 2403—1/8-inch router. 1.55
- (AA) 9 A 2404—1/8-inch router. 1.80
- (BB) 9 A 2409—1/8-inch dovetail. 1.30
- (CC) 9 A 2410—1/8-inch dovetail. 1.35
- (DD) 9 A 2411—1/8-inch dovetail. 1.55
- (EE) 9 A 2415—1/8-inch carving. 1.55
- (FF) 9 A 2416—1/8-inch carving. 1.80

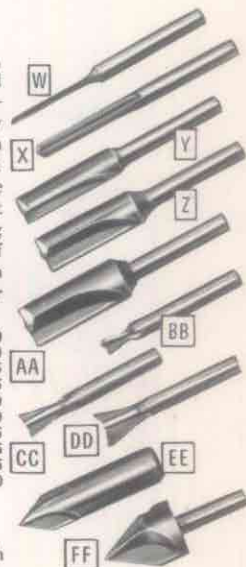

Collet Chucks

- GG** Screw-on type collet chuck. Use with cutters above. Fit drill press or any 1/2-inch x 20 thread spindle (see 9A2310 and 9 A 2172, page 27). 9 A 2271—1/2-in. capacity. Shpg. wt. 3 oz. **98c**
- 9 A 2269—1/2-in. cap. Shpg. wt. 3 oz. **\$1.20**

- HH** Collet chuck for cutters above or any 1/2 or 3/8-in. diam. shank. 1/2-in. capacity with 1/2-in. bushing. Fits any drill press with No. 33 Jacobs taper spindle having threaded locking collar on quill. Replaces 3-jaw chucks for any work developing side thrust, as in routing. Threaded collar holds chuck securely. 9 A 2455—Shpg. wt. 8 oz. **\$1.35**

Circular Hole Saw

- JJ** For drill presses, electric drills, etc. Finest heat treated high speed steel. Cuts clean, round holes in wood or metal. Depth of cut 1/2 in. Fits 1/2-in. chuck or larger. Mandrel, center drill and blade complete. *State size.*
- | Size, in. | 1/2 | 1 1/4 | 1 3/4 | 2 | 2 1/2 |
|-----------------|--------|--------|--------|-------------|-------------|
| Shpg. wt. 8 oz. | 6 oz. | 14 oz. | 15 oz. | 1 lb. 4 oz. | 1 lb. 6 oz. |
| 9 A 2698 | \$3.69 | \$3.69 | \$3.69 | \$4.10 | \$4.59 |
- Saw Blade only for circular hole saw**
- | Size, in. | 1/2 | 1 1/4 | 1 3/4 | 2 | 2 1/2 |
|-----------|-------|-------|-------|-------|-----------------|
| Shpg. wt. | 5 oz. | 6 oz. | 8 oz. | 9 oz. | 12 oz. 15 oz. |
| 9 A 2697 | 89c | 89c | 89c | 89c | \$1.29 \$1.79 |

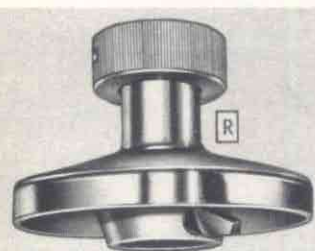

Rotary Planer

R CRAFTSMAN. Five tools in one! Does routing, planing, rabbeting and paneling. Dresses, trues-up and finishes all types of wood. Won't burn, gouge or scratch. Excellent for removing paint, varnish, etc., from old boards. Fits drill presses having No. 33 Jacobs taper and 1 1/16-in. x 20-threaded side thrust nut or locking collar. Diam. 3 3/8 in. With Allen wrench and instructions. Shpg. wt. 11 oz. 9 A 2745. **\$3.95**

CRAFTSMAN Mortising Chisel Housing

Cut square holes with your drill press. Housing mounts on quill. Bit drills round hole; hollow chisel trims corners square. Makes drill press a mortising machine that cuts clean, accurate mortise joints.

- S** 9 A 2463—Mortising Chisel Housing. For drill presses 99AM2314 and 99AM2313 (page 26), and 99AM2364 and 99AM2362 (page 27). Use with 9A2420 and 9A2422 (listed below), or almost any mortising chisel and bit. Shipping weight 3 pounds. **\$3.50**
- 9 A 2461—Mortising Chisel Housing. For former CRAFTSMAN drill presses Nos. 2380, 2382, 2407, 2423 and 2392. Use with 9A2420 and 9A2422 (listed below), or almost any mortising chisel and bit. Shipping weight 3 pounds. **\$3.00**
- T** 9 A 2420—Hollow Chisel. For 9A2463 and 9A2461 listed above. 1/4, 3/8 and 1/2-in. *State size.* Shpg. wt. 4 oz. **\$2.85**
- U** 9 A 2422—Mortising Bit. For 9A2420 (listed above). 1/4, 3/8 or 1/2-in. *Please state size.* Shpg. wt. 4 oz. **\$1.75**
- V** CRAFTSMAN Sanding Drums. For drill presses, flexible shafts, electric drills, etc. 1-in. faces; 1/2-in. plain spindle, 1 1/4-in. long. Use with a collet chuck. (Listed at right.) 9 A 2497—1 1/2-inch diameter. Shpg. wt. 5 oz. Each **85c**
- 9 A 2498—2 3/8-in. diameter. Shpg. wt. 5 oz. Each **\$1.00**
- 9 A 2499—3-inch diameter. Shpg. wt. 7 oz. Each **1.10**
- 9 A 2442—Sanding Drum Sleeves. Choice of fine or coarse grit, in pkg. of 6. *State diameter, and grit wanted.* Shpg. wt. 3 oz. Pkg. **39c**

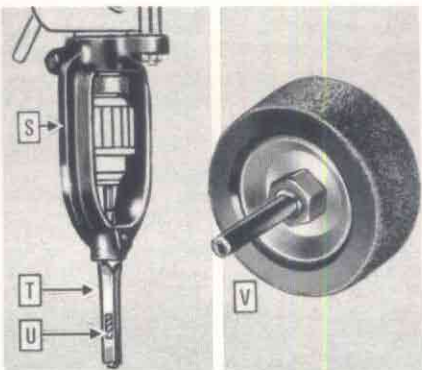

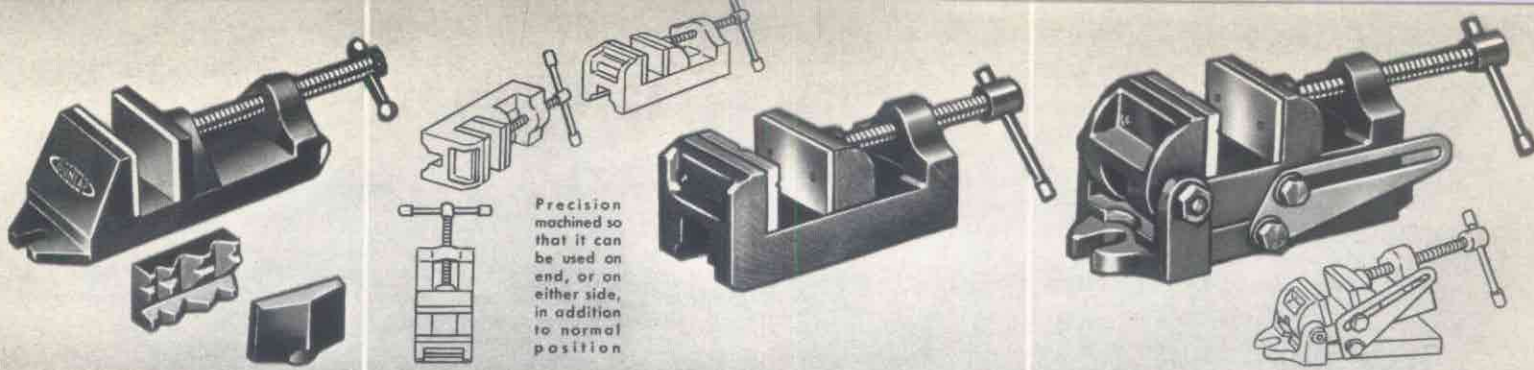

Precision machined so that it can be used on end, or on either side, in addition to normal position

Fine quality, useful Drill Press Accessories

DUNLAP Drill Press Vise

A low-priced vise to increase accuracy of your drilling operations . . . holds work firmly in position while it is being drilled or worked on. Increases the range in size of work you can handle. Makes working with small pieces easier, safer, and more convenient. Strong, accurately-cut steel screw; knurled end; sliding handle. Cast of non-ferrous metal. 2 3/8-inch jaws with steel faces; open 3 inches. With 2 extra cast iron jaws; one for round or irregular work; one for tapered pieces. Overall length 10 1/2 in.

\$310

9 A 2436—Shipping weight 4 pounds. \$3.10

CRAFTSMAN Drill Press Vise

Our newest and finest drill press vise! Precision-squared sides make it possible to use this vise on end, or on either side, in addition to its normal position. Can be used with magnetic chuck. Accurately machined from highest quality iron castings. Adjusting screws are made of hardened steel with a fine pitch thread and long bearing in vise body. 2 7/16-inch hardened steel jaws are grooved horizontally and vertically for holding round pieces; open to 2 1/2 inches. Overall length 7 1/2 inches.

\$495

9 A 2755—Shipping weight 4 lbs. 12 oz. \$4.95

CRAFTSMAN Angle Vise

Designed for quick, accurate set-ups without the use of clamps or wedges. Can be adjusted to full 90 degrees or used like ordinary vises when horizontal. Accurately graduated and ready for instant use by locking support screws. Can be used with magnetic chuck. Accurately machined from highest quality iron castings. Hardened steel adjusting screws; fine pitch thread; long bearing in vise body. 2 5/16-inch hardened steel jaws are grooved for holding round pieces; open to 2 1/2 inches. Overall length 9 inches.

\$795

9 A 2756—Shipping weight 9 lbs. 12 oz. \$7.95

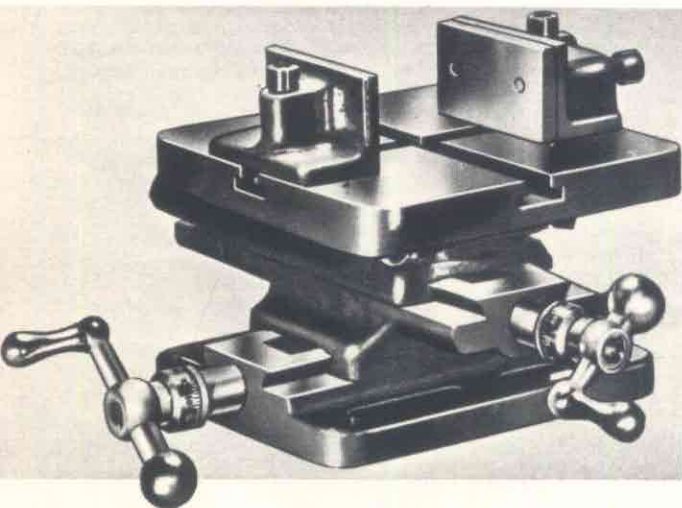

CRAFTSMAN Drill Press Milling Vise

Use this drill press milling vise to increase the usefulness of your drill press! This versatile accessory enables you to handle all types of accurate drilling, layout and spacing work—straight lines, radial and circular work; also light milling. Can be used with shaper, lathe or grinder for jobs in which accurate feeds in one or two directions are required.

\$3350 CASH
\$3.50 DOWN

Bolts on drill press table. The work is locked on the table between two adjustable jaws. By use of the two cross feed controls, work may be moved to any desired horizontal position. Base is graduated through 180 degrees so vise table may be rotated to any angle and set accurately.

Table is 7x7 inches. Travel on both cross feeds is 6 inches. Capacity of vise is 3 1/2 inches. Husky jaws are 3 inches wide; 1 1/2 inches high. Dovetailed ways assure smooth, accurate operation at all times. Comes with wrench. Shipping weight, 32 pounds.

99 A 02432 \$33.50

Buy any accessories you wish on Easy Terms. See inside front cover

CRAFTSMAN Roto-Vert Senior

For drill press and electric hand drills having chuck capacity of 1/2 inch or greater. Easily attached to drill presses having depth gauges as illustrated. Converts electric drill or drill press into a power sawing and filing machine. Uses standard hack saw blades and files.

\$1095

Only two moving parts . . . both made of tough, wear-resistant tool steel. No gears or springs to break or get out of order. Solid brass case has gray wrinkle finish; contrasting chromium plated trim. All parts accurately machined and assembled. 5 7/16 inches long. With instructions.

9 A 2600—Shipping weight 2 lbs. 13 oz. \$10.95

30 . . . SEARS, ROEBUCK AND CO. Zone 1

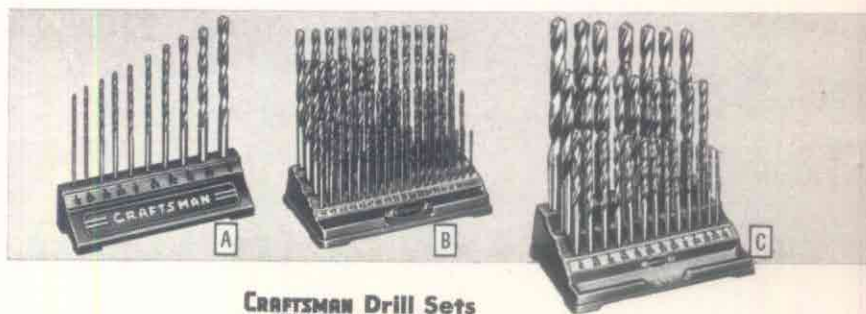

CRAFTSMAN Drill Sets

Our finest CRAFTSMAN twist drills for home, shop and industrial use. Highest quality steels, expertly tempered and hardened. Precision ground to exact size; cut cleanly and easily in wood or metal. Your choice of low speed carbon tool steel or high speed steel. Use carbon tool steel

drills for hand, breast or bench drills operating at relatively low speeds; use high speed drills for high speeds in electric drills and power driven drill presses. Sets come in drill stands with hole sizes clearly marked for quick selection of drills. Stands may be used as drill gauges.

- A** Ten-piece drill sets in drill stands. Sizes 1/16, 3/64, 1/32, 1/64, 1/8, 3/64, 5/32, 3/16, 1/32, and 1/4 inch. Shpg. wt. per set, 8 oz. 9 A 6705—10-pc. carbon tool steel drill set and stand. . . . \$1.85
- B** Sets of 60 wire gauge drills, sizes 1 to 60, in drill stands. Shipping weight, per set, 2 lbs. 12 oz. 9 A 6701—60-pc. carbon tool steel set and stand. \$8.95
- C** Sets of 29 drills, sizes 1/16 to 3/8 inch by 64ths, in drill stands. Shipping weight, per set, 4 lbs. 2 oz. 9 A 6702—29-pc. carbon tool steel set, stand. \$10.25
- 9 A 6703—10-pc. high speed steel set and stand. . . . \$3.50
- 9 A 6707—60-pc. high speed steel set and stand. \$18.50
- 9 A 6704—29-pc. high speed steel set and stand. . . \$21.75

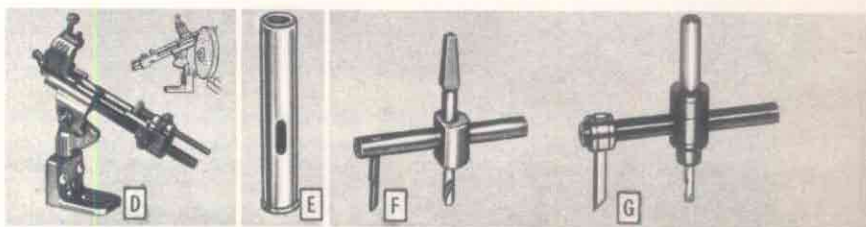

Drill Grinding Attachment

D CRAFTSMAN. Now you can repoint your drills with factory accuracy! Strong, non-rusting die-cast aluminum frame. May be adjusted for all popular drill point angles, including countersinks. Will handle twist drills of the following sizes: 1/8 to 3/4 in.; No. 1 to No. 30; A to Z; 3.0 to 19.0 millimeters. Easy to use. Instructions. 9 A 6677—Shipping wt. 2 lbs. 8 oz. . . . \$4.95

Tapered Adapter

E Enables you to fit #2 Morse male taper shank drill to #33 Jacobs male taper spindle. Shipping weight 8 oz. 9 A 2445 \$2.40

CRAFTSMAN Circle Cutters

- F** For small jobs. Tapered square shank for standard bit brace. Cuts hole 1 to 5 1/2-inch diameter. Easy adjustment. Removable high speed steel bit. 9 A 3640—Shipping wt. 10 oz. . . . \$2.29
- G** Heavy duty for larger jobs. 3/4-inch shank for use in drill presses or electric drills. Easy adjustment. Cut holes 2 to 8-inch diam. up to 1 inch deep; in sheet steel, aluminum, brass, wood, plastic, fiber, etc. For pipe or ventilator holes; instrument panels on radios, autos, etc. With removable high speed steel bit. 9 A 3641—Shipping wt. 10 oz. . . . \$4.50

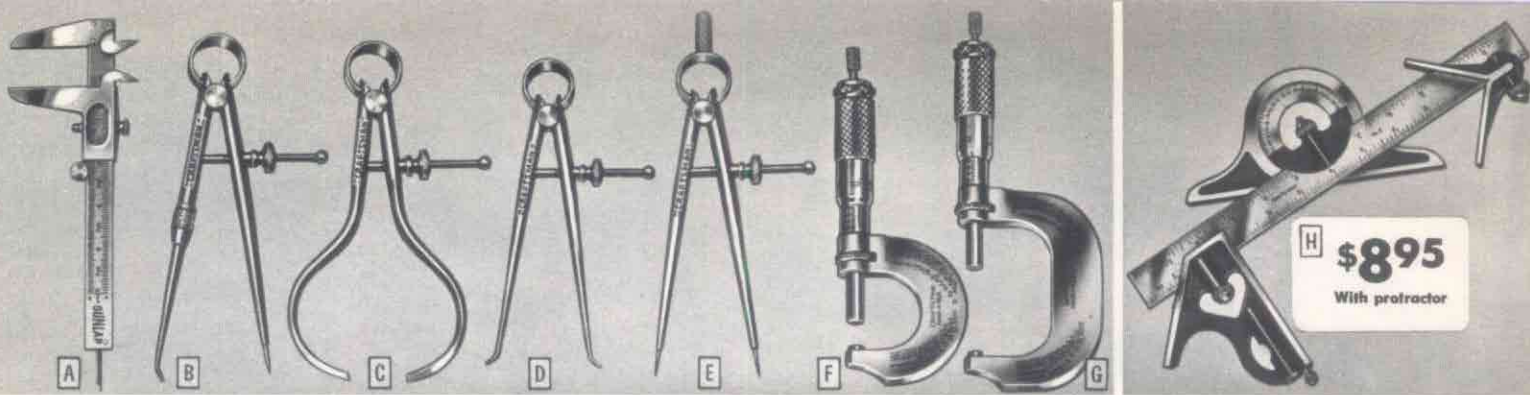

CRAFTSMAN Precision Tools . . . guaranteed accurate

Calipers, Dividers, Micrometers, Combination Squares

A DUNLAP Vernier Calipers. For inside or outside measurements, or for use as a depth gauge. Graduated in 16ths and 32nds of an inch; 1/128-inch vernier. Clear, easy-to-read graduations. 5 inches long. Shpg. wt. 5 oz.
9 A 4022.....**95c**

B CRAFTSMAN Toolmakers' Hermaphrodite Calipers. For the most precise laying out work, for accurately locating centers, etc. Many improvements over conventional flat leg pattern—round legs and stiff springs give more rigidity; eliminate wobbling. Finest alloy stainless steel. Replaceable point.
9 A 3853—Please state size.
4 inch. Shpg. wt. 10 oz.....**\$1.65**
6 inch. Shpg. wt. 12 oz.....**1.85**

CRAFTSMAN Toolmakers' Calipers and Dividers. For the most sensitive adjustments and most precise work. Stiff spring and tapered spool eliminate wobble at the points. Finest alloy stainless steel. Replaceable points on dividers. Order by catalog number and be sure to state size wanted.
Size..... 4 in. 6 in.
Shipping weight..... 4 oz. 6 oz.
(C) 9A3851—Outside Calipers.....**\$1.65 \$1.85**
(D) 9A3852—Inside Calipers.....**1.65 1.85**
(E) 9A3850—Dividers.....**1.65 1.85**

F CRAFTSMAN Micrometer. Ratchet and spindle lock. Forged steel frame. Tool steel anvil, spindle, screw. Graduated to 1/1000 in. Decimal equivalents on frame. Capacity 0 to 1 in.
9 A 4069—Wt. 8 oz.....**\$13.25**
G 9 A 4071—As above but larger. Capacity 1 to 2 in. With test gauge.
Shpg. wt. 14 oz.....**\$14.95**

H CRAFTSMAN Combination Squares. 12-in. polished steel blade, graduated in 8ths, 16ths, 32nds, 64ths. Handle has level and scriber; lock nut holds setting. 360° graduated turret protractor with level. Shipping wt. 1 lb. 14 oz.
9 A 4039.....**\$8.95**
9 A 4037—As above, but without protractor. State size.
6-inch blade. Wt. 14 oz.....**\$5.75**
12-inch blade. Wt. 1 lb. 4 oz. 3.98

H \$8.95
With protractor

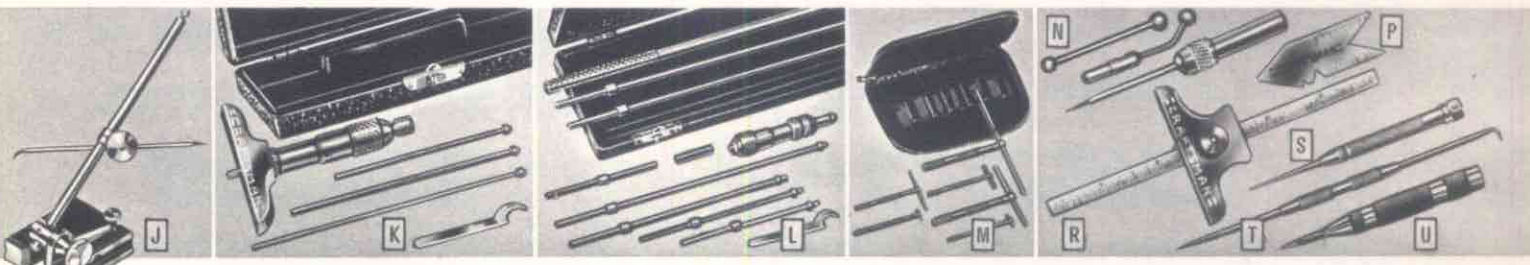

Gauges, Micrometers, Wiggler Set, Center Punch, Scribers

J CRAFTSMAN Surface Gauge. Professional quality. Base, 2 3/4 x 1 1/2 x 3/4 inch, is slotted so spindle can be turned down for use as a depth gauge. Base carefully ground for work on surface plates. With two spindles, 9 and 12 in. long. 5-in. scriber. Spring control holds scriber and head at any point by tightening a thumb nut.
9 A 4055—Shpg. wt. 1 lb.....**\$5.50**

L CRAFTSMAN Inside Micrometer. Makes all inside measurements by 1/1000ths of an inch, from 2 to 12 1/2 in. Seven measuring rods and long handle. In cotton plush-lined case.
9 A 4073—Shpg. wt. 1 lb. 8 oz.....**\$14.75**

N CRAFTSMAN Wiggler or Center Finder Set. Three precision tools in one! Ball shaft, bent indicator shaft and needle-point shaft. Chuck tension adjustable. 4 1/2 in. long over-all.
9 A 4021—Shpg. wt. 8 oz.....**\$1.89**

S CRAFTSMAN Pocket Scriber. Knurled steel body; replaceable steel point. Shipping weight each, 4 oz.
9 A 4051—Please state size wanted.
3/4-inch diameter.....**45c**
5/8-inch diameter.....**55c**

K CRAFTSMAN Micrometer Depth Gauge. Spindle has full one-inch movement; graduated in 1000ths of an inch. Three measuring rods give 0 to 3-in. capacity. Base is 2 1/2 in. long, 1/2 in. wide; hand lapped at right angles to rod. Comes in plush-lined case.
9 A 4046—Shpg. wt. 14 oz.....**\$14.25**

M CRAFTSMAN 6-piece Telescoping Gauge Set. For measurements in slots and holes. One plunger is telescoping; locks in position by slight turn of knurled screws. Ends of each head heat treated. 6 gauges: 1/16 to 1/2-inch range; 1/2 to 3/4-inch; 3/4 to 1 1/4-inch; 1 1/4 to 2 1/4-inch; 2 1/4 to 3 1/2-inch; 3 1/2 to 6-inch. Packed in blue leatherette case with zipper fastener. Shipping weight 10 ounces.
9 A 4027.....6-piece set **\$14.50**

P CRAFTSMAN Center Gauge. For checking lathe centers, etc. U.S. Standard 60° gauge. Tempered steel with ground edges. Graduated in 14ths, 20ths, 24ths, 32nds.
9 A 4064—Shpg. wt. 4 oz.....**.75c**

T CRAFTSMAN Double Scriber. Knurled steel body. Replaceable tempered points; one bent. Over-all length 9 in.
9 A 4014—Shpg. wt. 6 oz.....**.65c**

R CRAFTSMAN Depth Gauge. Also angle gauge. 6 x 1 1/2-in. tempered spring steel rule; 32nds on one side, 64ths on other. Tension nut holds rule at 30, 45, 60 and 90°. 2 1/2-in. head.
9 A 4044—Shpg. wt. 4 oz.....**\$2.39**

U CRAFTSMAN Adjustable Center Punch. For spotting metals, plastics, etc.; staking rivets and nuts. One-hand operation; no hammer needed. Replaceable alloy steel point. 1/2-inch diameter; 5-inches long. Comes in plastic tube.
9 A 4054—Shpg. wt. 8 oz.....**\$2.50**

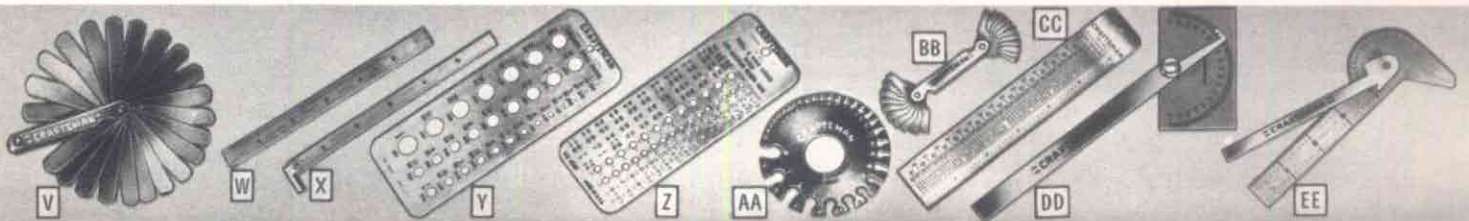

Feeler Gauge, Drill Gauge, Wire Gauge, Thread Gauge, Rules

V CRAFTSMAN 25-leaf Feeler Gauge. Finest professional quality. 3 1/16-inch spring steel blades, .0015 to .025 inches. Thicknesses range from .0015 to .2755 inches.
9 A 4057—Shipping wt. 7 oz.....**\$2.98**

X CRAFTSMAN Machinists' Hook Rule. Professional quality. Tempered Steel. Length, 6 in.; width, 3/8 in. Graduated in 64ths on one side; 32nds on other.
9 A 4035—Shpg. wt. 4 oz. **\$1.85**

AA CRAFTSMAN Wire Gauge. Our finest. Steel, gunmetal finish. American standard. Sizes, 0 to 36.
9 A 4023—Shipping wt. 6 oz.....**\$2.75**

BB CRAFTSMAN Thread Gauge. Finest quality. Gives screw pitches on V-threads. 22 pitches, 9 to 40.
9 A 4048—Shipping wt. 2 oz.....**\$1.65**

W CRAFTSMAN Steel Rules. Professional quality. Made of crucible steel. Edges are carefully ground and polished. Machine etched; sharp graduations are easy to read. Shpg. wt. each 6 oz.

CRAFTSMAN Drill Gauges. Professional quality. Made of hardened steel, polished.

CC CRAFTSMAN Reference Table-Rule. Tempered steel, 6-in. rule. Fractions, decimals, graduations to 32nds, one side; reference table for tap and drill data, 64ths other side.
9 A 4011—Shipping wt. 4 oz.....**.45c**

DD CRAFTSMAN Protractor. Professional quality. Stainless steel. Rectangular head has 4 working faces. Graduated 0 to 180 degrees.
9 A 4029—Shipping wt. 4 oz.....**98c**

Catalog No.	Size, In.	Graduations	Type	Each
9 A 4031	6x1 1/2	1/32, 1/64	Flexible	\$1.19
9 A 4032	6x3/4	1/8, 1/16, 1/32, 1/64	Solid	1.19
9 A 4033	12x1	1/8, 1/16, 1/32, 1/64	Solid	1.98

V 9 A 4049—Fractional sizes. 29 sizes, 1/16 to 1/2 in. Shpg. wt. 4 oz.....**98c**
Z 9 A 4047—Wire gauge sizes. Sizes 1 to 60. Wt. 7 oz.....**98c**

EE CRAFTSMAN Combination Rule. Stainless steel. Square bevel protractor, circle finder, divider, drill gauge. Marked in 32nds and 64ths. Comes in protective leatherette case.
9 A 4026—Shipping wt. 4 oz.....**98c**

Build your order up to \$20 and use Sears Easy Terms. See inside front cover for all the details

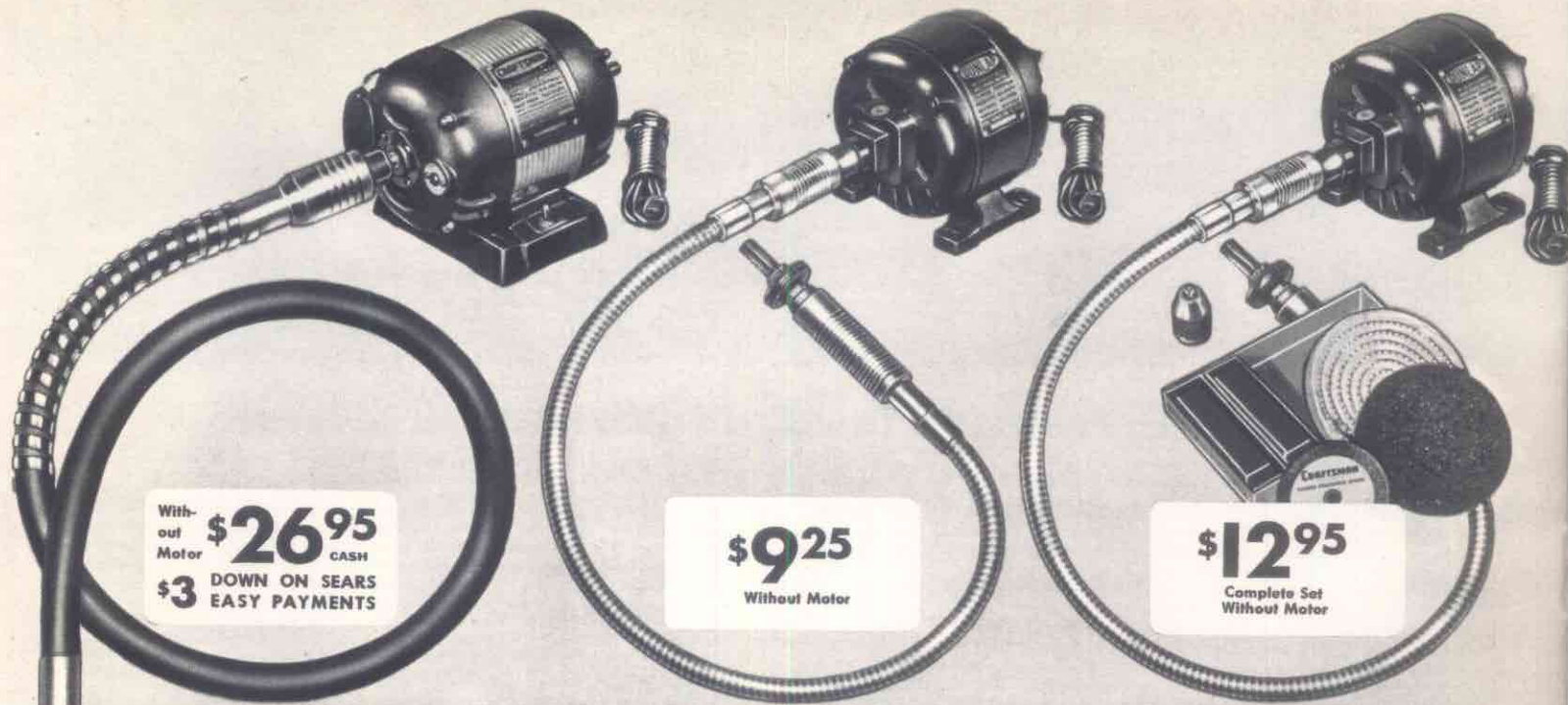

CRAFTSMAN Flexible Shafts . . many tools in one

Construction features below show why you get superior performance



72-in. casing has an oil-tempered spring steel liner with an oil-resistant cotton fabric jacket inside a steel wire and braid reinforced synthetic rubber cover. Motor-end is spiral steel reinforced for resistance to wear.

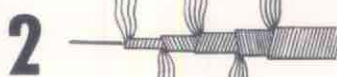

Cores of helically wound, high carbon steel wire (23 wires, 5 layers in 50-inch shaft; 35 wires, 6 layers in 72-inch shaft) have tensile strength of 240,000 to 270,000 pounds per square inch.



50-in. shaft casing has inner layer of tempered spring steel. Outer layer of soft steel resists lubrication leakage; also resists rust. Makes shaft more flexible . . . run smoother.

CRAFTSMAN 72-inch Flexible Shaft

Extra long . . . and tough. Ideal for heavy duty use in garages, shops, factories and industrial plants.

Chrome plated steel hand piece and motor coupling both have extra large precision ball bearings for smoother operation and longer wear. Knurling on hand piece gives firm, non-slip grip. Black, rust resistant steel end fittings.

Extra long, 72-inch shaft. Fits $\frac{1}{2}$ -inch motor shaft. Spindle is $\frac{1}{2}$ -inch, 20-thread. Core is of $\frac{1}{2}$ -inch high carbon steel wire, helically-wound, multiple-strand. Inner casing is of helically wound steel, covered with heavy, abrasion-resistant synthetic rubber jacket . . . steel impregnated . . . will not scratch surfaces.

Unusually flexible! Absolutely leakproof! Supports core evenly. The spiral steel chrome finish outer reinforcement at end of shaft protects jacket. Complete with casing, core, motor coupling, hand piece and simple instructions for correct usage.

- 99 A 02655—CRAFTSMAN 72-inch Flexible Shaft without motor. Shipping weight 11 lbs. . . . \$26.95
- 99 AT 2629—CRAFTSMAN 72-inch Flexible shaft with $\frac{1}{2}$ -H.P. 1750 R.P.M. capacitor ball bearing motor for 110-120 volt 60-cycle A.C. Shpg. wt. 45 lbs. . . \$51.90
- 9 A 2682—Extra Core for above flexible shafts. Shipping weight 3 lbs. 4 oz. . . . \$6.75

CRAFTSMAN 50-inch Flexible Shaft

For general use in the home, garage or repair shop. It's smooth . . . quiet running . . . and transmits power from motor to driven tool with minimum power loss.

50 inches long. Fits any $\frac{1}{2}$ -inch motor shaft. Smooth operating, ball bearing hand piece, with $\frac{1}{2}$ -inch 20-thread spindle. The motor coupling also runs on ball bearings. Hand piece and motor coupling are made of non-rusting aluminum alloy. Black, rust-resistant end fittings.

Two layers of steel in casing. Inner layer is tempered spring steel and outer layer is soft steel. Practically leakproof. $\frac{3}{4}$ -inch core is made of helically-wound high carbon steel wire. Complete with casing, core, motor coupling, hand piece and instructions.

- 99 A 02633—CRAFTSMAN 50-inch Flexible Shaft without motor. Shipping weight 5 lbs. . . . \$9.25
- 99 AT 2619—CRAFTSMAN 50-inch Shaft with $\frac{1}{2}$ -H.P. 1750 R.P.M. sleeve bearing split phase motor for 110-120 volt 60-cycle A.C. Shpg. wt. 28 lbs. . . \$19.75
- 9 A 2634—Flexible Shaft Extension (not shown). 38 inches long. Same construction as above flexible shaft. Without hand piece or motor coupling. Shipping weight 3 pounds 6 ounces. . . . \$3.65
- 9 A 2622—Extra Core for above flexible shaft or extension. Shipping weight 1 pound. . . . 2.15

CRAFTSMAN 50-in. Flexible Shaft Set

Makes grinding, sanding, cleaning, polishing, drilling, and rust removal far easier. Set includes:

Flexible Shaft. 50 inches long over-all; fits $\frac{1}{2}$ -inch motor shaft. Casing has 2 layers of steel consisting of an inner layer of tempered spring steel and an outer layer of soft steel. Ball bearings in hand piece and in motor coupling. Aluminum alloy housings. Black, rust-resistant steel end fittings. Has $\frac{3}{4}$ -inch core of multiple-strand, helically-wound high carbon steel wires. Spindle is $\frac{1}{2}$ -inch by 20-thread.

Motor. DUNLAP $\frac{1}{2}$ -H.P. 1750 R.P.M. sleeve bearing split-phase for 110-120 volt 60-cycle A.C.

Buffing Equipment. 6-in. double-thickness sewed buff; 6-oz. bar of rouge buffing compound for soft, nonferrous metals; 5-oz. bar of Tripoli (brown) buffing compound for aluminum, brass, wood, plastics, etc. Also 4-in. rubber and abrasive polishing wheel, $\frac{1}{2}$ in. thick, $\frac{1}{2}$ -in. bore; 5 $\frac{1}{2}$ -in. flexible sanding plate with medium grit abrasive; 3-jaw chuck, screw-on type, $\frac{1}{4}$ -in. capacity.

- 99 AT 2651—Complete set, with motor. Shipping weight 32 pounds . . . \$23.45
- 99 A 02630—Complete set, without motor. Shipping weight 8 pounds 10 ounces. . . . 12.95

Flexible Shaft Accessories

- A CRAFTSMAN Wheel Guard.** Protects hands and eyes from danger of flying particles and grit. Fits 99 A 02633 and 99 AT 2619 (listed above) or any flexible shaft with $\frac{1}{2}$ -inch diameter hand piece. Hand guard. Use with any 4-inch grinding wheel or wire wheel. 9 A 2637—Shipping weight 2 lbs. 4 oz. . . . \$3.50
- B CRAFTSMAN Wheel Guard.** Made to fit 99 A 02655 and 99 AT 2629 (listed above) or any flexible shaft with $\frac{1}{2}$ -inch diameter hand piece. Has hand guard. For use with 4-inch grinding wheel or wire wheel. 9 A 2638—Shipping weight 2 lbs. 4 oz. . . . \$3.50
- C CRAFTSMAN Angle Head.** Ideal for sanding and polishing operations. Gives better control of sanding discs . . . for more accurate work. Cast aluminum head. Ball bearings take thrust; needle bearings take radial load. 1-to-1 gear ratio. Removable rubber grip handle. Fits only 99 A 02655 and 99 AT 2629 (listed above). 9 A 2628—Shipping weight 2 lbs. 8 oz. . . . \$29.95

Grinding Tools

Mounted grinding tools for use on flexible shafts. Points made of highest quality vitrified aluminum oxide. Accurately mounted on $\frac{1}{2}$ -inch steel shafts; run true. For finish work, die cutting, or other grinding work. Sizes given are stone sizes. Use 9 A 6458 for sharpening 9 A 2420 hollow chisel (page 29). Shipping weight each 3 ounces.

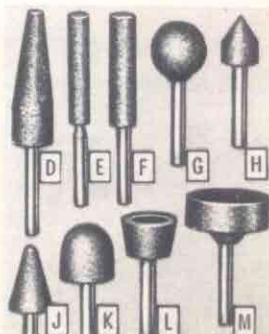

Catalog No.	Diameter	Length	Each
(D) 9 A 6461	$\frac{3}{4}$ in.	2 $\frac{1}{2}$ in.	45c
(E) 9 A 6453	$\frac{3}{8}$ in.	2 in.	45c
(F) 9 A 6462	$\frac{1}{2}$ in.	2 in.	45c
(G) 9 A 6459	1 in.	1 in.	45c
(H) 9 A 6458	1 $\frac{1}{2}$ in.	$\frac{3}{8}$ in.	45c
(J) 9 A 6457	$\frac{3}{4}$ in.	1 $\frac{1}{2}$ in.	45c
(K) 9 A 6460	1 in.	1 in.	45c
(L) 9 A 6443	1 in.	$\frac{1}{2}$ in.	45c
(M) 9 A 6444	1 $\frac{1}{2}$ in.	$\frac{1}{2}$ in.	45c



**Accessories for
CRAFTSMAN**

Rotary Electric Tool

NOTE: Shipping weight for the CRAFTSMAN Rotary Tool accessories below is 2 ounces each.

Cutters: Cut soft metals such as aluminum, tin, lead, bronze, etc. rapidly; efficiently. Ideal for delicate designs in soft or hard wood.

- D 9 A 2670—Oblong cutter. Diam., 3/16 inch; 3/8 in. long.....59c
- E 9 A 2836—Ball cutter. Diameter 1 1/64 inch.....59c
- F 9 A 2671—Ball cutter. Diameter 7/32 inch.....59c
- G 9 A 2672—Cone cutter. Diameter 7/32 inch.....59c
- H 9 A 2673—Oval cutter. Diameter 7/32 inch.....59c
- J 9 A 2674—Flat cutter. 3/16 in. diam.; 3/16 in. long.....65c
- K 9 A 2837—Pointed cutter. Diameter 7/64 inch.....59c
- L 9 A 2656—Saw and Mandrel. Diameter 3/8 inch. .032 inch thick.....69c
- M 9 A 2689—Saw blade without mandrel. Diam. 3/8 in. 39c

High Speed Steel Drills. For use on wood, metals, plastics, etc.

- N 9 A 2684—High speed drill. Diameter 1/16 inch.....35c
- P 9 A 2685—High speed drill. Diameter 3/32 inch.....35c
- R 9 A 2686—High speed drill. Diameter 1/8 inch.....35c

Brushes. Ideal for hard-to-get-at places, polishing, cleaning out cavities; many other jobs.

- S 9 A 2679—Disc type bristle brush. 3/8-inch diameter.....15c
- T 9 A 2680—Cup type bristle brush. 3/8-inch diameter.....15c
- U 9 A 2681—Mounted portable polishing brush. 3/16-inch diameter.....15c

Mounted Emery Wheels. For shaping or for giving a fine, smooth finish to metal. Choice of sizes and shapes as shown for wide variety of jobs.

- V 9 A 2653—1-inch diameter; 3/8-inch thick.....35c
- W 9 A 2654—3/8-inch diameter; 3/8-inch long.....35c
- X 9 A 2675—5/16-inch diameter.....29c
- Y 9 A 2676—3/8-inch taper emery wheel.....29c
- Z 9 A 2677—3/16-inch diameter; 3/8-inch long.....29c
- AA 9 A 2678—3/8-inch diameter; 3/8-inch long.....29c
- BB 9 A 2831—3/8-inch diameter; 3/8-inch long.....29c
- CC 9 A 2832—3/8-inch diameter; 3/8-inch long.....29c

Polishing Wheels, Sanding Drums, and Abrasive Discs.

- DD 9 A 2951—Set of 3 buffing wheels. 1 1/8-in. diam.....35c
- EE 9 A 2977—Set of 3 felt buffers. 1-in. diam.....35c
- FF 9 A 2952—Set of 3 rubber-bonded polishing wheels. 3/8-inch diameter.....29c
- GG 9 A 2953—Set of 3 knife-edge rubber taper wheels. 3/8-inch diameter.....29c
- HH 9 A 2696—Mounted sanding drum assembly with sanding sleeve. 3/8-in. diameter; 3/8-in. width.....39c
- JJ 9 A 2699—Set of 4 replacement sanding sleeves for above sanding drum assembly.25c
- KK 9 A 2691—Set of 12 silicon carbide discs. 1-inch diameter; 1/32-in. thick. Mounting hole size 1/16-inch diam.....29c

Mandrels. Steel. Ideal for mounting various accessories above.

- LL 9 A 2666—Nut and collar type.....17c
- MM 9 A 2667—Screw-in-end type.....17c

\$19.50
CASH
\$2.00 DOWN . . ON
EASY TERMS

CRAFTSMAN Rotary Electric Tool
REG. U. S. PAT. OFF.

Hundreds of uses in every industrial or home workshop

Expert craftsmen, hobbyists—even novices will get a real thrill from using this superb CRAFTSMAN Rotary Electric Tool. It will help you turn out fine work, quickly, easily, accurately . . . for pleasure or profit! Excellent for home or shop, hobby or professional work . . . for maintenance, tool room, light production work . . . and scores of other jobs!

You can use the CRAFTSMAN Rotary Electric Tool for grinding, drilling, routing, carving, sawing, cutting, engraving and sharpening . . . on wood, metal, glass, leather, plastics and other materials. It polishes, buffs, brushes, smooths and cleans . . . truly a whole shop-full of tools in one!

Notice all these quality features! Precision-built throughout! Powerful, 18,000 R.P.M. universal motor for 110-120-volt, 25-60 cycle, A.C. or D.C. . . has improved fan-cooling system; grease-packed precision ball-bearing in front; self-aligning rear bronze bearing. Large size brushes are replaceable from outside. Balanced armature and built-up commu-

tator. Built-in condenser reduces radio static. Has positive-break, on-off switch. 1000-volt tested. Entire tool—not just cord and plug—approved by Underwriters' Laboratories, Inc. Has removable pistol-grip handle, and removable finger-rest over chuck for close, accurate work. Accurate collet chuck with 2 collet inserts (capacities, 3/32-inch and 1/8-inch) assures solid locking of accessories. With 5 1/2-foot heavy rubber covered cord, and unbreakable plug. Overall length of tool, 7 inches. Weighs only 1 3/4 pounds, less cord.

The leader for completeness. 35 accessories assure great versatility. Set includes one each of all the accessories shown at right plus extra mandrels, sanding sleeves and abrasive discs, ripping guide, 2 chuck wrenches, collet chuck, with 2 collet inserts, emery wheel dresser, and set of motor replacement brushes . . . actually 52 pieces in all . . . in lined, simulated leather covered workshop case.

9 A 2652—Shipping weight 3 pounds 4 ounces . . . \$19.50

CRAFTSMAN Deluxe Electric Hand Grinder

A Rugged quality, for particular craftsmen in shop or tool room. Underwriters' Labs. approved. Extra capacity . . . handles 3/32, 1/8 and 1/4-in. shank tools. Extra power . . . 4 times the power of 9A2652. 17,000 R.P.M. motor (110-120-volt, 25-60 cycle A.C. or D.C.); 8-ft. cord, and plug; Handles big jobs without stalling. Extra versatility . . . sands, sharpens, grinds, saws, etc., works in wood, metal, plastics, glass. Extra utility . . . converts in seconds to a flexible shaft tool (see 9A2517, below). Aluminum slip-sleeve covers chuck for safety; permits more accurate work. Complete with 25 accessories: files, burrs, wheels, brushes, arbors, etc. In metal box.

9 A 2516—Shipping weight 6 lbs. 4 oz. . . . \$26.95

CRAFTSMAN Flexible Shaft and Hanger Set

B Converts 9A2516 into a high-speed flexible shaft tool in seconds. Also for electric drill or drill press. 36-in. shaft; cover resists moisture, oil, grease. 5 1/2-in. handpiece. Slip-sleeve covers chuck. For 3/32 and 1/8-in. shank tools. Nickel-plated hanger bracket holds 9A2516 grinder as shown.

9 A 2517—Shipping weight 2 lbs. . . . \$10.50

CRAFTSMAN High-speed Flexible Shaft Outfit

C Look at the many features of this new flexible shaft outfit. Pen-type handpiece permits more accurate work. Sensitive finger-tip control. Motor doesn't obstruct view of work. You can grind, polish, sharpen, engrave, clean, mill, carve, etc. . . . do dozens of other jobs on metal, wood, glass and plastics. 15,000 R.P.M. motor (110-120-volt, 25 to 60-cycle, A.C. or D.C.); 2 3/4 times more powerful than 9A2652. 8-ft. cord, and plug. 30-in. flexible shaft; 5 1/2-in. handpiece with aluminum sliding sleeve over chuck (holds 3/32 and 1/8-in. shank tools); 10 accessories. In sturdy metal case.

9 A 2515—Shipping weight 5 lbs. 6 oz. . . . \$24.50

Speed Control Foot Switch. Five controlled speeds plus "on" and "off". For 1/100 to 1/14-H.P. universal motors. Use with any electric tool above. With 4-ft. and 6-ft. cords and plugs. Size, 7x4x4 in.

9 A 2518—Shpg. wt. 1 lb. 12 oz. . . . \$3.39

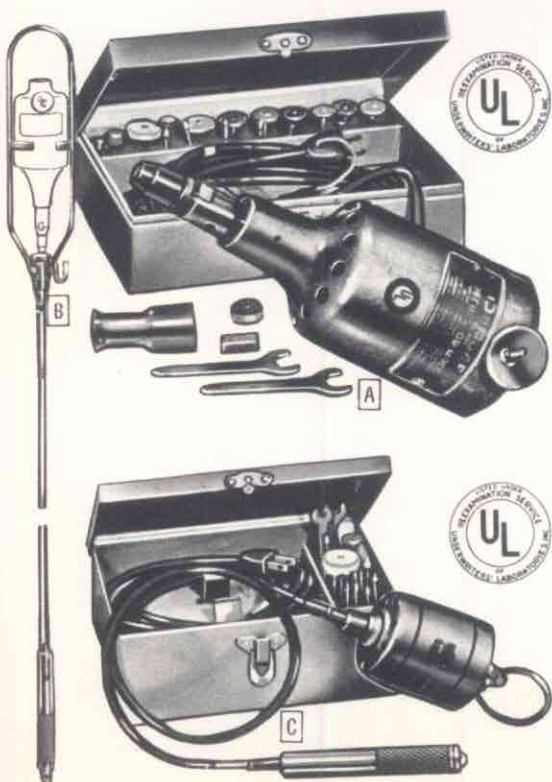

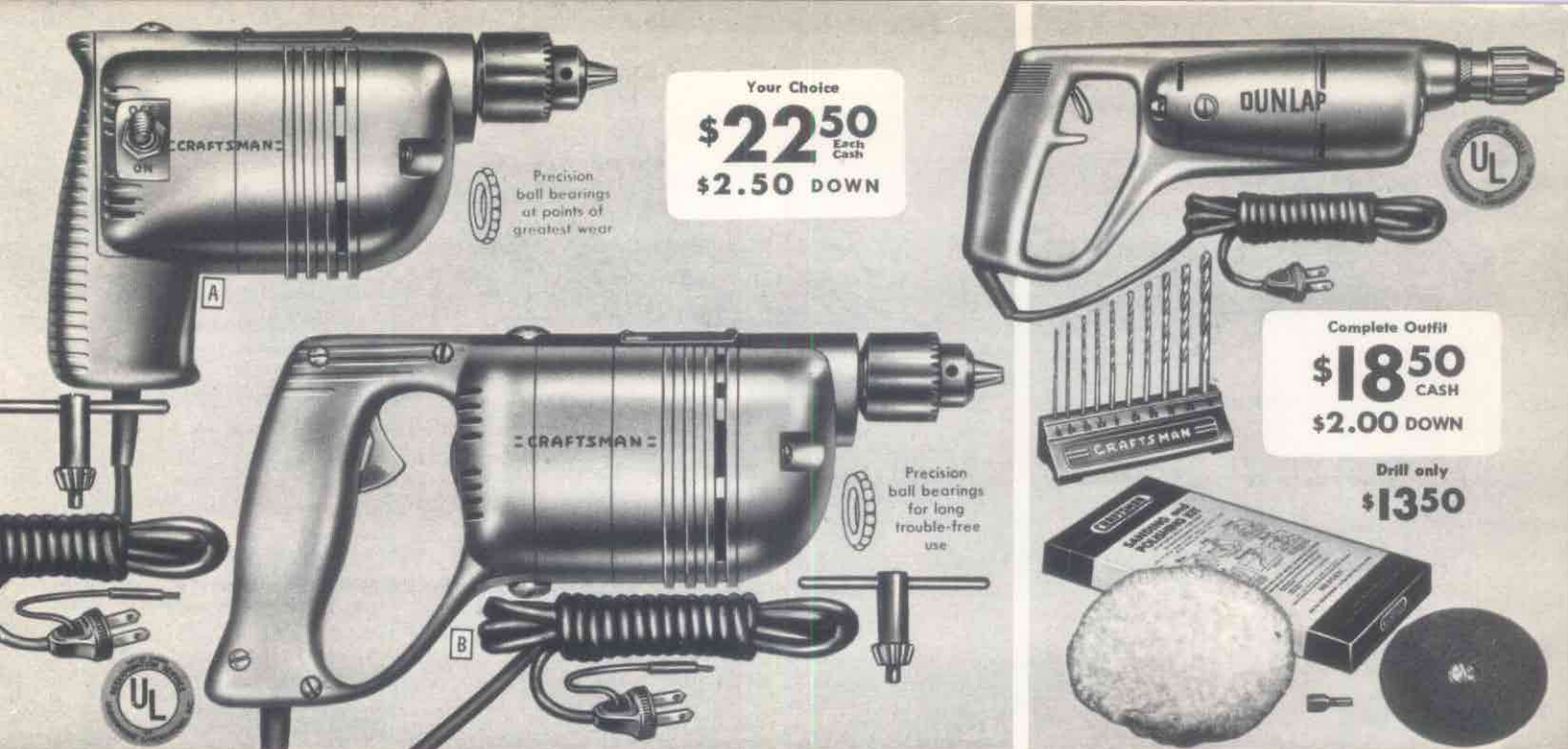

Your Choice
\$22.50 Each
\$2.50 DOWN

Complete Outfit
\$18.50 CASH
\$2.00 DOWN

Drill only
\$13.50

CRAFTSMAN 1/4-in. Electric Drills . . . power-packed

CRAFTSMAN "80" . . . small, handy, general-purpose type

These popular, powerful little brutes are taking the place of large, heavy, hard-to-handle drills. That's because these CRAFTSMAN "80" drills are small . . . light . . . easy to handle, even in close places . . . and literally packed with power. Ideal for use by maintenance men, small shops, garages, hobby shops, etc. Don't let their size and weight fool you! We tried to stall one of them, using a 1/4-inch bit on steel plate . . . it just couldn't be done!

Expertly designed and engineered. Durable die-cast aluminum frame is exceptionally strong for its light weight (actually less than 3 pounds). Ball bearing construction gives true-running, dependable, long life. Precision ball bearing on front end of motor; self-aligning rear bearing. Spindle needle bearing; ball thrust bearing. Equipped with famous Jacobs No. 1B geared key chuck . . . 1/4-inch capacity . . . seats drills firmly, yet easily removed.

Double reduction gears . . . precision machine-cut from special alloy steel . . . perfectly meshed for smooth, quiet operation and lower, more practical spindle speed. No-load chuck speed, 1600 R.P.M. Equipped with powerful universal motor for use on 110-120 volt, 25 to 60-cycle, A.C. or D.C.; approved by Underwriters' Laboratories, Inc. Each drill comes complete with 10-foot, 3-wire, rubber-covered power cord and unbreakable plug. Your choice of two popular models—with pistol-grip handle or saw-grip handle, as listed below.

A 9 A 2577—Pistol-grip handle. Has single pole toggle switch. Over-all length 7 3/4 in. Shpg. wt. 4 lbs. 4 oz. . . . \$22.50

B 9 A 2578—Saw-grip handle. Has single pole safety trigger switch. Over-all length 9 3/4 in. Shpg. wt. 4 lbs. 8 oz. . . . \$22.50

DUNLAP Drill Outfit

Complete drilling, sanding and polishing outfit at low cost for the home workshop. Good quality DUNLAP utility drill is for intermittent use; compact; strong; will drive 1/4-in. bits in steel. Has bronze bearings; triple-reduction gears; 1/4-in. capacity 3-jaw chuck (1500 R.P.M. no-load speed). Die-cast aluminum frame; saw-grip handle; trigger switch. Underwriters' Labs. approved. 110-120 volt 25-60 cycle A.C.-D.C. universal motor; 6-ft. cord; plug. Length 12 in. over-all.

Also includes 10 high speed drills 1/16 to 1/4-in. in stand; 6-in. sanding disc; 7-in. lamb's wool polishing bonnet; chuck adapter (1/2-in.-20 thread; 1/4-in. shank). *Note the low price.*
 9 A 2576—Complete Outfit, as above. Shipping weight 5 lbs. . . . \$18.50
 9 A 2575—DUNLAP 1/4-inch Electric Drill only. Shpg. wt. 3 lbs. 12 oz. . . . \$13.50

Use these quality Accessories to get the most from your Electric Drill



Grinding Wheel Arbor (See page 35)



Tampico Floor Brush (See page 40)



Wire Cup Brush (See page 40)



Wire Scratch Wheel (See page 40)



Sanding Drum (See page 40)



Rubber Polishing Wheel (See page 40)



Sanding Plate (See page 41)

CRAFTSMAN Drill Press Stand

\$11.95 Now you can convert any 1/4-inch electric drill on this page into a fast, accurate, sturdy drill press. Greatly increases drill's usefulness . . . ideal for maintenance shops and hobbyists.

Drills can be easily installed in clamp and quickly aligned. Clamp can be rotated 360°. Permits horizontal polishing and sanding as well as vertical drilling. Feed handle has compound leverage . . . makes it easier to drill through steel. Built-in compression spring holds drill in raised position when not in use.

Maximum head travel, 2 1/2 in. Outside column diameter, 1 1/2 in. Depth of cut collar. Cast iron base table has 6x6-in. ground working surface; with center hole and diagonal slots. Overall height 25 in. Can also be used with 9A2516 electric hand grinder (see page 33). Shpg. wt. 16 lbs. 99 A 02589 . . . \$11.95

Buy on Sears Easy Terms! See Inside front cover.

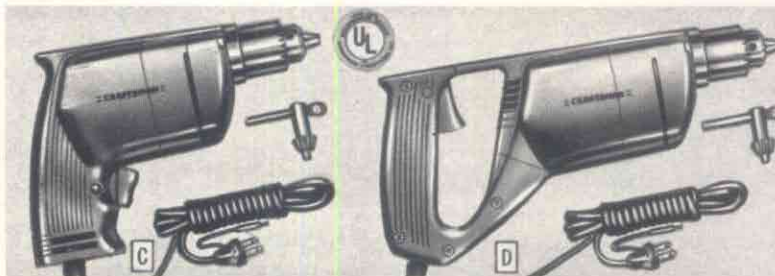

CRAFTSMAN "100" Drills . . . 1/4-in. heavy-duty type

More for your Money with a CRAFTSMAN "100" Drill! Laboratory comparison with two famous heavy duty drills shows the CRAFTSMAN "100" similar in performance . . . at a huge saving! Actually it sells for even less than standard duty drills by the same makers!

	Sears drill	Drill X	Drill Y
Maximum H.P.20	.234	.194
Full load H.P.15	.16	.138
No load R.P.M.	1600	1700	1800
Full load temperature rise	53°C	52.5°C	42°C
Efficiency	51.4%	53.5%	51.2%
U.L. approved	YES	NO	NO
Price	\$33.50	\$42.00	\$41.00

Your Choice
\$33.50 Each
\$3.50 DOWN

For continuous, heavy duty production. *Not standard duty drills, but genuine heavy duty design . . .* at less than standard duty drill prices! We believe they're the finest 1/4-in. heavy duty, close-quarter drills you can buy! Super-powered, 110-120 volt, 25-60-cycle, A.C.-D.C. universal motor; won't stall on toughest jobs. Approved by Underwriters' Laboratories, Inc. Strong, lightweight, die-cast aluminum alloy frame. 1/4-in. Jacobs 7B geared key chuck. Double-reduction, nickel-chrome-molybdenum steel gears. Two precision ball bearings on motor shaft; two on gear spindles; one for thrust. Needle bearing on chuck spindle. No-load chuck speed 1600 R.P.M. Single pole trigger switch; automatic safety release; lock for continuous running. 10-ft., 3-wire cord; plug.
C 9 A 2570—Pistol-grip handle. 7 3/4 in. long. Shipping weight 5 lbs. . . . \$33.50
D 9 A 2571—Saw-grip handle. 10 3/4 in. long. Shpg. wt. 5 lbs. 3 oz. . . . \$33.50

\$38⁹⁵
CASH
\$4.00 DOWN ..

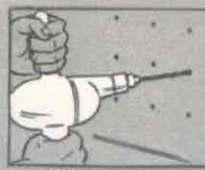

Drive twist drills

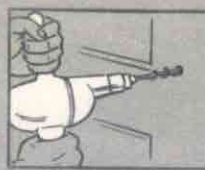

Drive wood augers

\$61⁹⁵
CASH
99 A 02585
\$6.50 DOWN ..

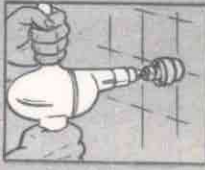
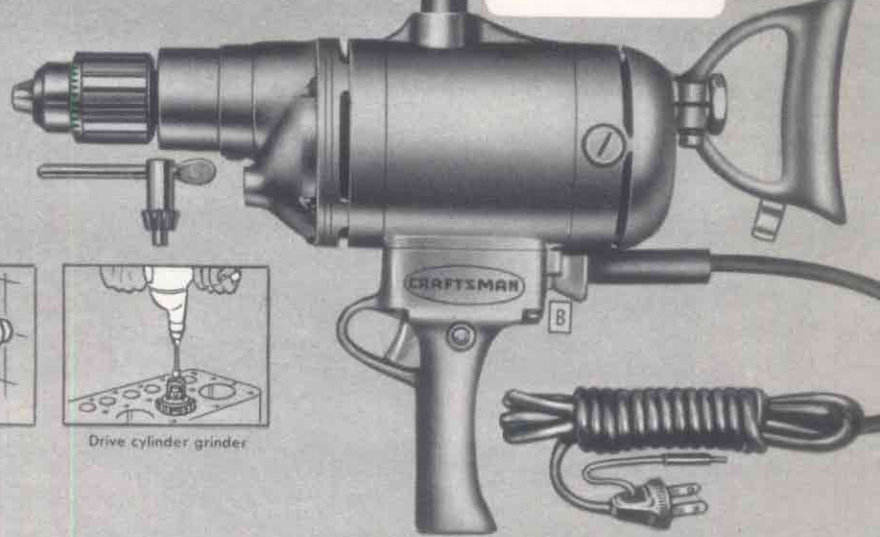
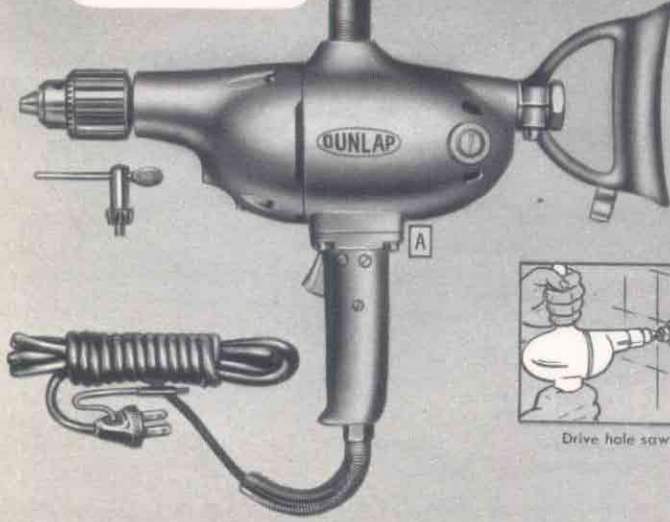

Drive hole saws

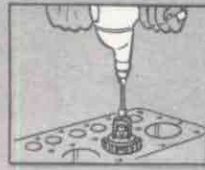

Drive cylinder grinder

Electric Drills . . 1/2-in. capacity or larger

DUNLAP 1/2-inch Electric Drill

A Economy-priced . . . yet has that extra power necessary for those tough jobs. Ideal utility drill for farmers, garage mechanics and maintenance men. It's well balanced and easy to handle. Runs smoothly and quietly without chatter.

Streamlined, lightweight but sturdy aluminum alloy frame. Gears, pinions, motor shaft and chuck spindle are of high quality, heat treated alloy steel. Double reduction gears of heat treated chrome nickel steel . . . improve with use. Self-lubricating bronze bearings; ball thrust bearing on spindle to take up end thrust. Top handle and rear grip are removable for close-quarter work.

Equipped with 1/2-inch capacity, No. 33B Jacobs geared key chuck . . . finest chuck available. Underwriters' Laboratories approved, fully enclosed, double-pole automatic releasing switch; locks for continuous running. Powerful universal motor operates on 110-120-volt, 25 to 60-cycle A.C. or D.C. No-load spindle speed 400 R.P.M.; most practical speed for general drilling, hole saws, wood augers, twist drills, cylinder grinders, etc. Comes complete with 10-foot 3-wire rubber-covered cord and unbreakable plug. Overall length 16 inches.

99 A 02584—Shipping weight 15 pounds \$38.95

CRAFTSMAN production-type Drills

B Built for heaviest production work in shop, factory or mill. Has plenty of surplus power . . . won't stall on any job when used with the largest drill size specified. Ball bearing construction, lightweight aluminum frame, and modern design give these rugged drills maximum operating ease and efficiency.

Special triple reduction gears are heat treated chrome-nickel steel . . . supply extremely high torque. Armature shaft runs smoothly on New Departure ball bearings; sealed in oil. Equipped with genuine Jacobs geared key chuck. Underwriters' Laboratories, Inc. approved double-pole switch locks for continuous running. Top and rear handles removable for close-quarter work. Heavy duty, universal ball bearing motor for use on 110-120-volt, 25 to 60-cycle A.C. or D.C. Comes with 10-foot, 3-wire, rubber-covered cord and unbreakable plug. Over-all length, 18 1/2 inches. Available in three sizes (see table below).

Catalog Number	Size	R.P.M.	Shipping Weight	Price
99 A 02585	1/2-inch	750	20 pounds	\$61.95
99 A 02586	3/4-inch	525	21 pounds	69.95
99 A 02587	1-inch	475	21 pounds	74.95

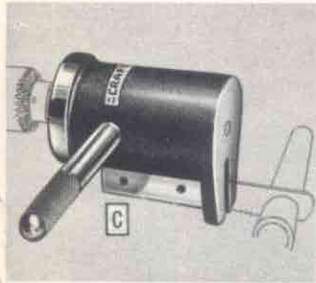

C

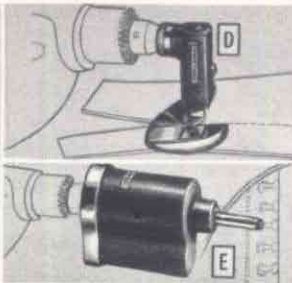

D

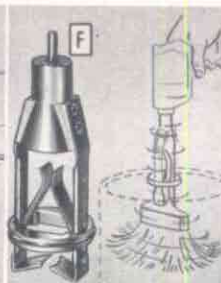

E



G

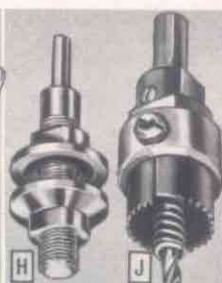

H



J

Accessories for 1/4-in. Electric Drills

Solid brass cases; gray wrinkled finish. Only two moving parts in each tool; no gears or springs. For general use with spindle speeds 1600 to 2500 R.P.M. Instructions included.

C CRAFTSMAN Roto-Vert. Converts your 1/4-in. electric drill into an efficient portable power saw and filing machine. Uses standard hack saw blades and files. Over-all length 3 3/4 in. 9 A 2590—Shipping weight 2 pounds \$9.75

D CRAFTSMAN Roto-Snip. Converts your 1/4-in. electric drill into a power shear. Cuts metal up to 20-gauge . . . in a straight line or in a circle down to 1 1/2-in. radius. Cutting edges are readily adjusted or resharpened. Over-all length 3 3/4 in. 9 A 2591—Shipping weight 2 pounds \$17.50

E CRAFTSMAN Roto-Pein. Converts your 1/4-in. electric drill into a light duty power hammer. Riveting attachment included. Other attachments below. Length, tool only, 4 1/4 in. 9 A 2592—Roto-Pein only. Shpg. wt. 2 lbs. 3 oz. \$6.25

Attachments for Roto-Pein

Catalog No.	Accessory	Size	Shpg. Wt.	Price
9 A 2595	Concrete Drill	1/2-in.	4 oz.	79c
9 A 2596	Cold Chisel	3/16-in.	3 oz.	49c
9 A 2597	Wood Chisel	1/2-in.	3 oz.	79c
9 A 2598	Center Punch	3/16-in.	3 oz.	49c

9 A 2599—Two 1/8-in. tool steel blanks (for roto-pein) that can be shaped as desired. Shpg. wt. 3 oz. Set 49c

Attachments to give your electric drill new uses

F Spin-A-Brush Attachment. Makes cleaning brushes much faster and easier! Fits 1/4-in. electric drills or larger of 1600 R.P.M. or less. Salvages paint-clogged brushes in just 90 seconds!

Easy to use. Just fasten Spin-A-Brush in drill chuck, center brush and soak in turpentine or thinner about 30 seconds. Centrifugal force cleans brush quickly. Enables quick change of colors, using same brush. Durable clamp; die-cast cup and ring; spring steel arms. Nickel plated; 1/4-in. diameter steel shank. Shpg. wt. 1 lb. 9 A 2605 \$2.19

G CRAFTSMAN Sander-Polisher. Fits 1/4-in. drills like 9A2577, 9A2578, 9A2570 and 9A2571 (on opposite page). For sanding or polishing furniture, woodwork, walls or other flat surfaces. Cast aluminum housing and base plate. Sealed ball bearing on eccentric drive. 3 1/2 x 7-in. oscillating pad. 6 1/2 in. high. With wrench and instructions. 9 A 2603—Shpg. wt. 2 lbs. 8 oz. \$9.95

H Arbor for Electric Drill. For holding grinding, wire or buffing wheels, etc. Carbon steel. 1/4-in. shank; 1/2-in. x 20-thread arbor. 1 1/4-in. flanges with nuts. 3 1/4 in. long. 9 A 2594—Shpg. wt. 6 oz. Each 60c

J Circular Hole Saw. Fits 1/2-in. drill or larger. Cuts holes in wood or metal. Depth of cut 1/2 in. With mandrel. *Slate size.*
Size, in. 3/4 1 1 1 1/2 2 2 1/2
Shpg. wt. 8 oz. 9 oz. 14 oz. 15 oz. 1 lb. 4 oz. 1 lb. 8 oz.
9 A 2698 \$3.69 \$3.69 \$3.69 \$3.69 \$4.10 \$4.59

Saw Blade only for circular hole saw
Size, in. 3/4 1 1 1/2 2 2 1/2
Shpg. wt. 5 oz. 6 oz. 8 oz. 9 oz. 12 oz. 15 oz.
9 A 2697 89c 89c 89c 89c \$1.29 \$1.79

Use these
Accessories
in your
Electric Drill



10-pc. Drill Set
(See page 30).



Carbon Removing
Brush (page 40).



Mounted grinding
tools (page 32).



New Departure Grease-sealed precision ball bearings



New Departure Grease-sealed precision ball bearings

A 1/2-H.P.
\$21⁹⁵
 CASH
\$2.50 DOWN

B 1/2-H.P.
\$35⁹⁵
 CASH
\$4.00 DOWN

Sears high quality Electric Motors

CRAFTSMAN Capacitor Motors...powerful!

A Efficient motors for shops, factories, etc., for driving tools or equipment. Note ALL features at left, included! Built-in condenser reduces starting current; motor starts loads about 50% heavier than split phase motors of same rating. New Departure grease-sealed precision ball bearings. Operates in any position; easily reversed. Specially designed fan and baffles keep all parts of motor cool. All are 110-120-volt, 60-cycle A.C., with 1/2-in. shafts, except 99A01981 has 3/8-in. keyway shaft. Mounting dimensions, 3 3/4 x 5 in.

Catalog No.	H. P.	R. P. M.	Shpg. wt.	Price
99A01977	1/2	1750	33 lbs.	\$21.95
99A01978	1/2	1750	34 lbs.	24.95
99A01980	1/2	3450	37 lbs.	27.95
99A01981	1/2	3450	44 lbs.	36.95

CRAFTSMAN Mill Type Motors

B Extra heavy duty for factories, farms, etc. Heavier windings; greater overload capacity. Condenser reduces starting current. New Departure grease-sealed precision ball bearings; use motor in any position. "Klixon" overload protector. 3/4 x 2 1/4-in. keyway shaft. Mounting dimensions 5 x 5 3/4 in. For 115-230-volt 60-cycle A.C. Easily reversed.

Catalog No.	H.P.	R.P.M.	Shpg. wt.	Price
99A01985	1/2	1750	53 lbs.	\$35.95
99A01986	3/4	1750	58 lbs.	43.95
99A01987	1	1750	63 lbs.	45.95

99 A 01906—1-H.P. 3450 R.P.M. Capacitor Motor. (Not shown.) Ball bearing; overload protector; double shaft (3/8-in. and 1/2-in.); on-off switch; 8-ft. cord with plug. 115-230-volt 60-cycle A.C. Mounting dimensions 5 x 5 3/4 in. Shpg. wt. 53 lbs. **\$45.95**



1 Heavy 8-ft. cord and unbreakable plug.



2 Overload protector prevents motor burn-out.



3 Shaft extends on both ends... more useful.



4 Convenient on-off switch built into motor base.

NOW! Nylon insulation used in all motors shown above. Gives much greater resistance to abrasion and heat.



C **\$10⁵⁰**
 1/4-H.P.



D **\$11⁹⁵**
 1/2-H.P.



E **\$16⁹⁵**
 1/2-H.P.

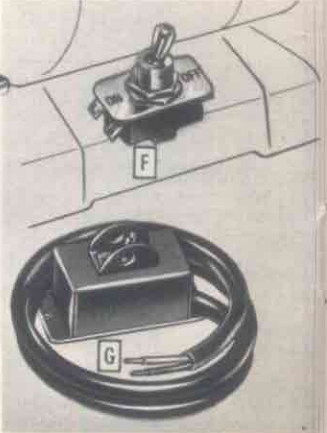

DUNLAP Split Phase Motors

Super values! Not lightweight, but full size, full power. Rugged, well-made motors, designed for general use on easy-starting loads such as washing machines, light power tools, etc. Excellent performance and trouble-free operation. All parts guaranteed against defects in material or workmanship. Exceed N.E.M.A. breakdown torques. Husky, diamond-bored precision bronze bearings for smooth operation and long life. Sealed oil chambers; don't need lubrication for at least 1000 hours operation. Motor should be used in horizontal position only. Easily reversed. Cast iron base gives motor solid mounting. 1/2-in. shaft extends 1 1/2-in. on one end. 1750 R.P.M. For 110-120-volt, 60-cycle A.C. With 8-ft. cord; unbreakable plug. Mounting dimensions 3 3/4 x 5 in.

- C** 99 A 01974—1/4-H.P. Shipping weight 23 pounds. **\$10.50**
- D** 99 A 01966—1/2-H.P. Shipping weight 26 pounds. **11.95**

1/3-H.P. Split Phase Motor

E **DUNLAP Deluxe.** Our finest split phase motor! Heavy duty! Super powered! Ideal for operating light power tools and compressors, ventilating fans, washing machines, etc. Note all these great features: double shaft, ball bearings, on-off switch, cord, and unbreakable plug. Exceeds N.E.M.A. specifications. Handles more than TWO times rated H.P. before stalling! Efficient, modern design. Deep end bells, large fan and baffled openings ventilate motor; assure cool operation. Massive cast iron base for solid mounting; handy on-off switch. Easily reversed. Extremely quiet running. All parts guaranteed against defects in materials or workmanship for one year. New Departure grease-sealed precision ball bearings; motor operates in any position. 1/2-in. shaft extends 1 1/2-in. on both ends; permits operation of two tools. 1750 R.P.M. For 110-120-volt, 60-cycle A.C. Heavy 8-ft. cord; unbreakable plug. Mounting dimensions 3 3/4 x 5 in. 99 A 01975—Shipping weight 27 pounds. **\$16.95**



Precision Ball Bearings

"On-off" motor Switches

- F** "On-off" Motor Switch. Same as used on our CRAFTSMAN Capacitor Motors 99A01977, 99A01978, 99A01980 and 99A01981, at top of page, and our 99A02616 and 99A02618 Grinders (see page 38). For motors 3/4-H.P. 3450 R.P.M. or smaller. 9 A 1921—Shipping weight 3 ounces. **69c**
- "On-off" Motor Switch. (Not shown.) Same as used on our 99A01975 motor shown at left. Can be used for motors up to and including 1 1/2-H.P. 9 A 1920—Shipping weight 3 ounces. **49c**
- G** Remote Control Switch. Far more convenient and safer than an ordinary motor switch. Mount it at front of machine with the rest of your controls, and start or stop motor with a flip of your finger! Switch mounted in 3 1/2 x 2 1/4-in. steel box. 4-ft. lead of heavy duty 14-gauge type "SJ" cord for motor connection. For motors up to and including 1-H.P. 9 A 1922—Shipping weight 1 lb. 8 oz. **\$3.69**



Grease-sealed precision ball bearings

A 1/2-H.P.
\$3650
 CASH
\$4.00 DOWN

B 1/2-H.P.
\$2550
 CASH
\$3.00 DOWN

C 3/4-H.P.
\$4595
 CASH
\$5.00 DOWN

Grease-sealed precision ball bearings

3-Phase, and R-I Type Motors

***3-Phase Ball Bearing Motors for 220-440-volt, 60-cycle A.C.**

Catalog Number	H.P.	R.P.M.	Size Shaft Inch	Base Mounting Inches	Shpg. wt. Lbs.	Cash Price
(A) 99A01910	1/2	1725	3/4	5 x 5 1/2	39	\$36.50
99A01911	3/4	1725	3/4	5 x 5 1/2	57	44.95
99A01912	1	1725	3/4	5 1/2 x 8	81	54.00
99A01913	1 1/2	1725	3/4	6 1/2 x 8	86	64.00
99A01914	2	1725	1	6 3/4 x 9	105	73.00
99A01915	3	1725	1	7 1/2 x 9	115	82.00
99A01916	5	1725	1 1/2	8 1/2 x 10	128	97.00

* Most homes and farms have single phase current. 3-phase is usually used in factories. Check with your local power company before ordering.

Super-powered for tough jobs!

Our finest! Used in shops and factories for steady day-in day-out production work. Tremendous overload capacity for the tough jobs! Easily handle hard starting loads. Develop THREE to FIVE times the rated H.P. while starting. Ideal for farms and for low voltage lines and rigorous climatic conditions.

Meet all A.I.E.E., N.E.M.A. and central station requirements. All have grease-sealed precision ball bearings... never need lubrication... run in any position. Husky, improved round frame for better ventilation. Large air vents and powerful fan keep extra heavy windings cool. Designed not to exceed 40 degrees Centigrade temperature rise under normal operation. Air vents drip-proof protected. Easily reversed. Shafts have keyways. Before ordering, check with your local power company on voltage, cycle, phase and capacity of your line.

CRAFTSMAN 60-cycle 110-220-volt Single Phase Repulsion-Induction

Catalog Number	H.P.	R.P.M.	Size Shaft Inch	Base Mounting Inches	Shpg. wt. Lbs.	Cash
(B) 99A01935	1/2	1725	3/8	3 x 4 1/2	32	\$25.50
99A01936	3/4	1725	3/8	5 x 5 1/2	36	36.50
(C) 99A01937	1	1725	3/8	5 x 5 1/2	61	45.95
99A01938	1	1725	3/8	5 1/2 x 8	84	65.00
99A01939	1	3450	3/8	5 x 5 1/2	74	45.95
99A01940	1 1/2	1725	3/8	6 1/2 x 8	96	85.00
99A01941	2	1725	1	6 3/4 x 9	130	110.00
99A01942	2	3450	3/4	6 1/2 x 8	96	95.00
99A01943	3	1725	1	7 1/2 x 9	141	140.00
99A01944	5	1725	1 1/2	8 1/2 x 10	192	210.00

IMPORTANT! Buy the Right Motor! Too small a motor is poor economy. A larger motor of more powerful type will last years longer than one slightly too small.
Split Phase Motors—For easy-starting loads or where maximum load is applied at full motor speed; washing machines, ventilating fans, light power tools, etc.
Capacitor Motors—For medium-starting loads; heavier power tools, paint sprayers,

refrigerators, stokers, shallow-well pumps (about 22 ft. or less), etc.
Mill-Type Capacitor Motors—For medium to hard-starting loads. Ideal for production equipment, compressors, heavy power tools, etc.
Repulsion-Induction and 3-Phase Motors—For hard-starting jobs; deep-well pumps, large compressors, heavy industrial tools and farm equipment, freezers, etc.

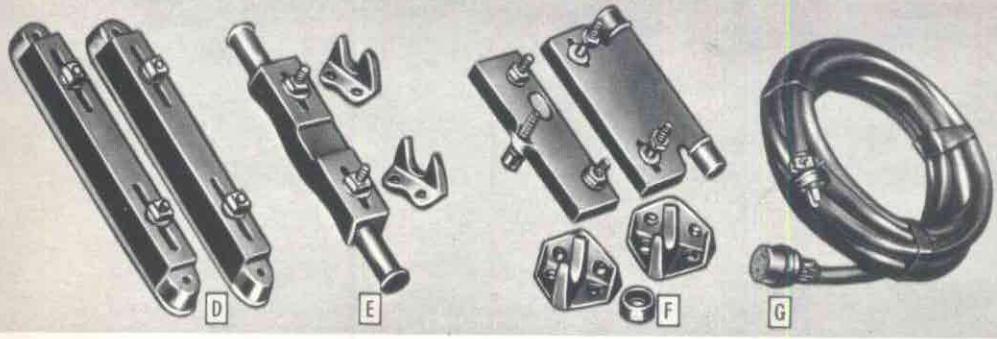

CRAFTSMAN Motor Rails . . Convenient . . Speedy

D Adjustable Motor Rails. For jobs where motor is not moved from tool to tool. Easy to adjust belts; simply loosen bolts holding motor to rail, slide motor for belt tension wanted, then tighten bolts. Do not run V-belts too tightly. Shipping weight 3 lbs.
 9 A 2279 Per pair **\$1.20**

E Floating Motor Rails. Permits using one motor for several tools. Fasten clips near each tool, and shift motor with rail attached, from tool to tool. Keeps belts at proper tension.
 9 A 2275—Floating motor rail and one pair clips. Shpg. wt. 1 lb. 13 oz. **.85c**
 9 A 2277—Rail clips only.
 Shipping weight 7 oz. Per pair **32c**

F Deluxe Floating Motor Rail. For smooth, vibrationless motor operation. Has all advantages of regular type; plus support for rear end of motor, rubber cushioning, and right angle clips. Clips allow motor to be mounted either behind or under tool. Rear rail pivot support is used to carry rear end of motor; pivot is adjustable. Fits nearly all fractional horsepower motors. Use with standard type clips if desired.
 9 A 2326—Complete set. Shipping weight 2 lbs. **\$2.10**
 9 A 2328—Rail clips only. Shpg. wt. 10 oz. Per pair **70c**

Extension Cord

G For use with all motors and portable electric tools. Handy; safe! By using this proper size cord you assure full voltage at your motor or portable tool; lessen danger of motor burn-out from low voltage. 25 feet of heavy No. 10 gauge 2-conductor wire; rubber covered. Type "SJ." Complete with heavy duty unbreakable rubber plug and connector. Approved by Underwriters Laboratories, Inc. Shpg. wt. 4 lbs. 11 oz.
 34 A 5884 **\$4.49**

Get more use from your motor!

Use these convenient arbors and chucks with your motor for buffs, polishing wheels, wire wheels, drills, etc. See page 24.

Use your motor as a sander, too. Get this handy sanding plate. See page 41.

You can buy any equipment in this book on Sears Easy Terms. See inside front cover for details

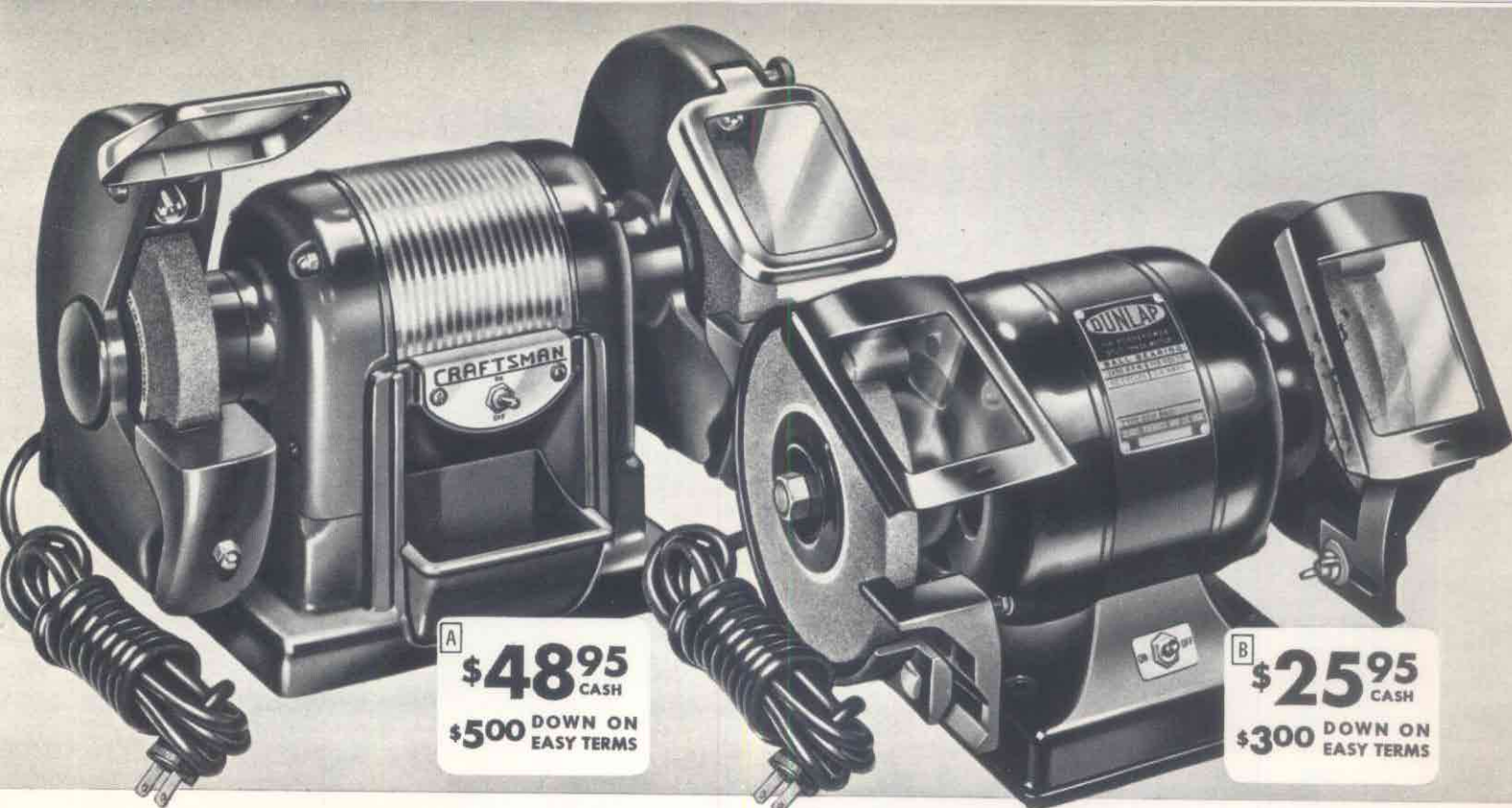

A
\$48⁹⁵ CASH
\$500 DOWN ON EASY TERMS

B
\$25⁹⁵ CASH
\$300 DOWN ON EASY TERMS

Precision-built Grinders for your shop

Get the most from your Grinder



Use wire scratch wheels for the removal of rust and paint from metal. See page 40



Use tampico brushes to remove burrs, corners; for brush finish effect. See page 40



Use rubber polishing wheels to polish and finish metals and plastics. See page 41



Use spiral-sewn buffs with buffing compounds for very high polish. See page 40

CRAFTSMAN 1/3-H.P. Grinder

A Incorporates the latest and best in grinder design! Excellent for heavy-duty grinding and sharpening in any type of shop.

Strength, beauty, utility. Heavy, rigid cast-iron frame . . . rubber mounted to absorb vibration. Finished in attractive CRAFTSMAN gray with contrasting chromium trim. Convenient removable built-in water pan of bright red plastic. Two 10-watt work lamps . . . one built into each wheel guard . . . rubber mounted . . . easily replaced.

Ample overload capacity to meet unusual power demands without burning out motor. CRAFTSMAN 1/3-H.P. capacitor motor is condenser-start induction-run type with new nylon-insulated windings. Balanced for vibration-free operation at 3450 R.P.M. Operates on 110-120 volt, 60-cycle A.C. power. Toggle switch located at front of grinder. 8-foot rubber-covered cord, and unbreakable plug.

New Departure precision ball bearings assure minimum friction and wear . . . sealed against dirt, dust and grit. Strong steel shaft is 3/8-inch diameter, turned down to 1/2 inch at each end.

For safety each grinding wheel is enclosed by a cast-iron wheel guard; rear dust chutes. Shatterproof glass eye shields mounted in chromium-plated frame. Ground cast-iron tool rests are adjustable.

Two industrial quality CRAFTSMAN vitrified aluminum oxide grinding wheels . . . one 36 grit for coarse grinding and one 70 grit for fine grinding. Thirteen-inch clearance between wheels. Operate safely at rated speed of 3450 R.P.M. **Dimensions** (without eye shields and tool rests): height 12 in.; width 17 in.; depth 8 3/4 in.

99 AM 2618—Shipping weight 98 pounds. **\$48.95**

DUNLAP 1/4-H.P. Grinder

B Designed to do most grinding jobs in small shops and for general maintenance work. An excellent utility grinder.

Equipped with 1/4-H.P. DUNLAP split-phase motor that operates on 110-120 volts 60-cycle A.C. power. Nylon insulated windings. Rated speed is 3450 R.P.M. Toggle switch conveniently located at front of grinder. Eight-foot rubber-covered cord, and unbreakable plug.

New Departure ball bearings are protected against dirt, dust, grindings and abrasive particles. You get dependable operation with a minimum of power loss due to friction. 3/8-inch steel shaft; turned down to 1/2 inch at wheel ends.

Two 6x3/4-inch fully vitrified CRAFTSMAN grinding wheels . . . one 36 grit wheel for coarse grinding and one 70 grit wheel for finer grinding and finishing. Operate safely at rated speed of 3450 R.P.M. Clearance between wheels is eleven inches.

Cast-iron wheel guards. Shatterproof glass eye shields in adjustable steel frames; protection from flying particles and sparks from grinding wheels. Removable, adjustable tool rests steady your work . . . assure greater accuracy.

Durable cast-iron frame for strength and rigidity. Finished in gray enamel. Rubber mounted for quiet operation.

Over-all dimensions (without eye shields and tool rests): height 8 3/4 inches; width 12 3/4 inches; depth 8 inches.

99 A 02616—Shipping weight 43 pounds. **\$25.95**

CRAFTSMAN general-purpose Grinding Wheels

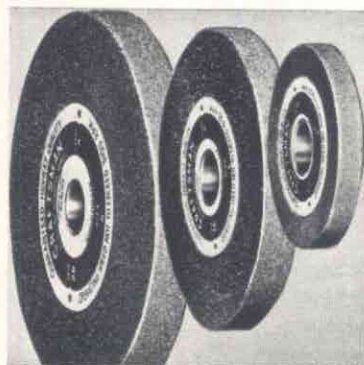

First quality; none finer; perfectly balanced. Dressed square, sides and face. Cut cool, fast and free. **New aluminum oxide abrasive.** Longest wearing. Tough, sharp, solid, uniform crystalline structure. Bonded and vitrified in an electrically-controlled furnace for over 150 hours. Wheels up to and including 8-in. diameter have 1-in. arbor holes. (*) Bushings furnished for shafts 1/4, 5/16, 3/8, 1/2, 5/8, and 3/4-in. diameter. **Please be sure to state shaft diameter.**

HOW TO ORDER: To send correct grinding wheel, we need catalog number of wheel you want, and: (1) Diameter of wheel. (2) Thickness of wheel. (3) Diameter of shaft.

SAFETY INFORMATION—(1) Use concave flanges as large or larger than recommended in table below. (2) Use guard and shatter-proof glass shield. (3) Don't exceed R.P.M. shown. (4) Wear safety goggles (see page 45).

Diameter wheel, inches	3	4	5	6	7	8
Diameter flange, inches	1 1/4	1 1/2	1 3/4	2	2 1/2	3
R.P.M.	8276	6207	4966	4138	3547	3103

Select the correct grit for your job:

FINE . . . for knives, keen-edged tools, finish grinding and polishing.

MEDIUM FINE . . . for chisels, axes, woodcutting tools, or preparing surfaces for finishing.

MEDIUM COARSE . . . for machine shop use, or fast removal of stock.

Diameter and thickness	Bore inches	Shpg. wt., lbs.	9 A 6412 Fine	9 A 6411 Medium fine	9 A 6415 Medium coarse
3x1/2 in.	1	1	43c	43c	
3x3/4 in.	1	1	45c	45c	
4x1/2 in.	1	1	65c	65c	
4x3/4 in.	1	2	75c	75c	
4x1 in.	1	2	89c	89c	
5x3/4 in.	1	3	\$1.10	\$1.10	
5x1 in.	1	3	1.35	1.35	
6x1/2 in.	1	3	1.15	1.15	
6x3/4 in.	1	3	1.35	1.35	
6x1 in.	1	4	1.59	1.59	
6x1 1/4 in.	1	4			\$1.79
7x3/4 in.	1	4		1.65	
7x1 in.	1	5	1.89	1.89	1.89
7x1 1/4 in.	1	6			2.15
8x1 in.	1	6		2.35	2.35
8x1 1/4 in.	1	7	2.65	2.65	2.65
8x1 1/2 in.	1	9	3.15	3.15	3.15

CRAFTSMAN Wet Grindstone

REG. U.S. PAT. OFF.



\$10⁵⁰
Without motor
\$21.75 with motor

Specially designed for industrial use

Extra heavy duty. Revolves in a bath of water... won't draw temper from tools. Highest quality natural Ohio grindstone, 10-in. diameter, 1½-in. face. Built-in gear train reduces stone to proper speed. Heavy cast-iron body. Durable cast-iron bearings. Adjustable 3-in. tool rest. Splash guard can be flipped back for grinding axe, etc., on top of stone. Drain plug in base. Comes with 4½-in. drive pulley. Use 1½-in. motor pulley with 1750 R.P.M. motor. Motor, V-belt and motor pulley are not included. Rust-resisting gray enameled finish.

99 A 06620—CRAFTSMAN Wet Grindstone only. Shipping weight 32 pounds. **\$10.50**
99 AT 6727—CRAFTSMAN Wet Grindstone with ¼-H.P. 1750 R.P.M. split-phase bronze bearing, 110-120-volt, A.C. motor, 1½-in. motor pulley and ½x36-in. V-belt. Shpg. wt. 56 lbs. **\$21.75**
9 A 6621—Replacement Stone only for above. Shipping weight 13 pounds. **3.75**

Power Grinders

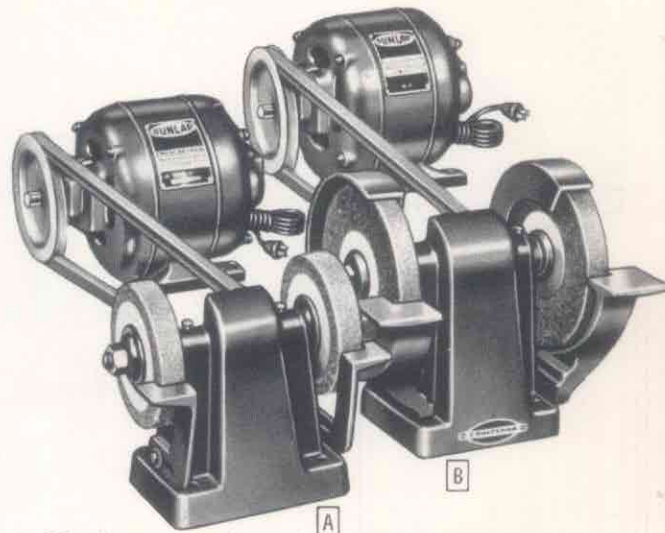

Make tough grinding jobs easy

A 4-inch Grinder, Cast-iron frame. Gray enameled. 8x¾-in. steel spindle, turned down to ½-in. x 20-thread at ends. Spring cap oil cups. Tool rests. Two 4x¾-in. grinding wheels; one fine, one medium grit. 2-in. pulley for V-belt drive. **\$525**
9 A 6628—Shipping weight 8 lbs. **\$5.25**
99 AT 6653—Grinder Head with ¼-H.P. 1750 R.P.M. split-phase bronze bearing 110-120-volt A.C. motor, 5-in. motor pulley and ½x34-inch V-belt. Shipping weight 32 pounds. **\$17.00**

B CRAFTSMAN 6-inch heavy-duty Grinder. 9¾-in. spindle; ½-in. diameter, turned down to ¾-in. x 20-thread at ends. Long porous bronze bearings. Oil well around each. Adjustable guards and tool rests. Spring cap oil cups. Gray enameled. Two 6x¾-in. vitrified grinding wheels; one fine, one medium grit. 1½ and 2½-in. pulleys for V-belt drive. **\$1050**
99 A 06614—Shipping weight 19 pounds. **\$10.50**
99 AT 6655—Grinding Head with ¼-H.P. 1750 R.P.M. split-phase bronze bearing 110-120-volt A.C. motor, 5-in. motor pulley and ½x34-inch V-belt. Shipping weight 43 pounds. **\$22.25**

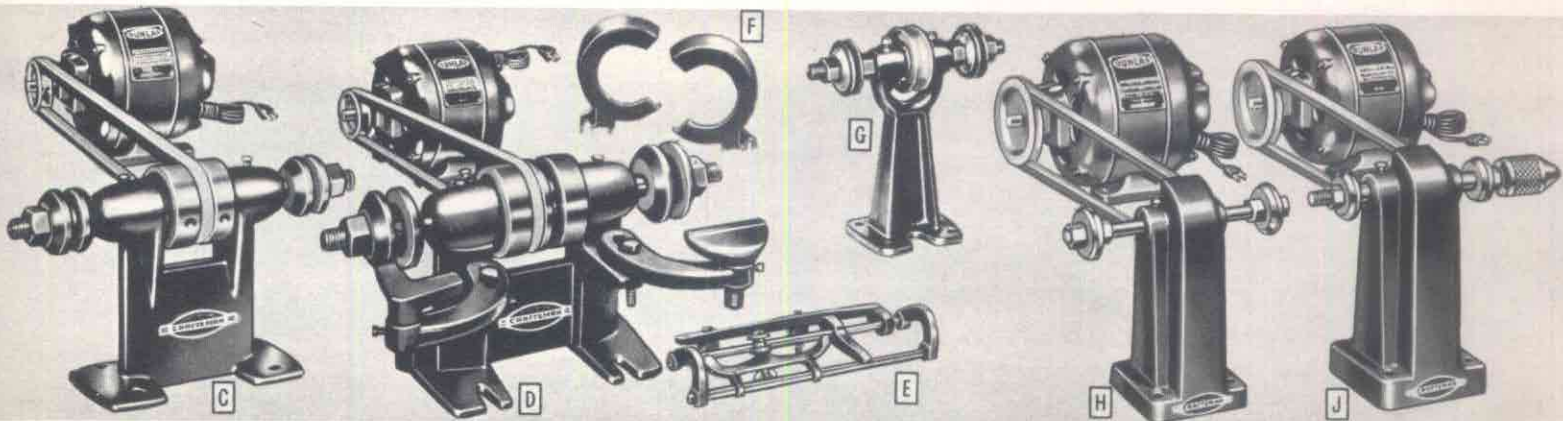

All-purpose Grinder

C Grinder Head. **\$400**
11¾-in. spindle; ¾ in. at ends. Long porous bronze bearings; oil well around each. 2-in. flat and single V-pulley. Holds grinding wheels up to 8x1 inches.
9 A 6616—Shpg. wt. 9 lbs. **\$4.00**
99 AT 6723—Grinder Head with ¼-H.P. 1750 R.P.M. split phase 110-120-volt A.C. motor, 4-in. motor pulley and ½x36-in. V-belt. Shipping weight 33 pounds **\$15.50**

99 A 06619—Same as 9 A 6616 but with two vitrified 6x1-in. grinding wheels. Shipping weight 16 pounds. **\$7.35**

99 AT 6724—Same as 99 A 06619 but with ¼-H.P. 1750 R.P.M. split phase 110-120-volt A.C. motor, 4-in. motor pulley and ½x36-in. V-belt. Shipping weight 40 pounds. **\$19.00**

CRAFTSMAN heavy duty Grinder

D 15½x½-in. spindle, turned down to ¾-in. at ends; takes up to 8x 1½-in. wheels with ¾-in. arbor holes. Two combination pulleys for flat or V-belts. Porous bronze bearings with oil well around each. Idling pulley locks for double V-drive. **\$750**
99 A 06629—Grinder Head only. Shipping weight 21 pounds. **\$7.50**
99 AT 6725—Grinder Head with ¼-H.P. 1750 R.P.M. split phase 110-120-volt A.C. motor, 4-in. motor pulley and ½x36-in. V-belt. Shipping weight 45 lbs. **\$19.00**
99 A 06631—Grinder Head with 2 CRAFTSMAN vitrified grinding wheels, 8x1½ in., and 5½x3½-in. vitrified sickle wheel. Shpg. wt. 40 lbs. **\$14.75**
99 AM 6726—Same as 99A06631 but with ¼-H.P. 1750 R.P.M. split phase 115-volt A.C. motor, motor pulley and V-belt. Shpg. wt. 64 lbs. **\$26.25**

E 9 A 6420—Sickle Holder. For 99A06629. Aligns mower knives. Shpg. wt. 4 lbs. **\$2.35**

F 9 A 6421—Guards. For 99A06629. 8-inch capacity. Shpg. wt. 4 lbs. **Pair \$2.50**

Polishing Heads . . sharpen, grind, polish, drill

G Low-priced Polishing Head. Well balanced. Sharpens tools, grinds, polishes, drills, etc. when used with proper accessories. Head is 7¼ in. high; spindle is 7x½-in., 20-thread. Stamped steel collars. Oil plugs. Can be driven from rear, above or below. Two-inch V-pulley included. Shpg. wt. 3 lbs. 7 oz. **\$195**
9 A 6615. **\$1.95**

Heavy cast iron frames, enameled gray. Spindles are threaded ¾-in., 20-thread. Porous bronze bearings; oil well around each. Spring cap oil cups. Drive from below or behind. 2-inch pulley for V-belt. **\$295**

H CRAFTSMAN Polishing Head. Height 7¾ inches. Machined steel flanges. **\$295**
9 A 6627—Polishing Head only. Shipping weight 6 pounds. **\$2.95**
99 AT 6657—Polishing Head with ¼-H.P. 1750 R.P.M. split-phase 110-120-volt, 60-cycle A.C. motor, 4-in. motor pulley, ½x34-inch V-belt. Shipping weight 30 pounds. **\$14.50**

J CRAFTSMAN heavy duty Polishing Head. Height 9¼ in. 3-jaw screw-on type chuck; ¾-in. capacity. Machined steel collars. **\$565**
9 A 6647—Polishing Head only. Shipping weight 9 pounds. **\$5.65**
99 AT 6658—Polishing Head with ¼-H.P. 1750 R.P.M. split-phase 110-120-volt, 60-cycle A.C. motor, 4-in. motor pulley, ½x34-inch V-belt. Shipping weight 33 lbs. **\$17.35**

EASY TERMS

Why not try Sears Easy Payment Plan? Details on inside front cover.

Accessories for use with...

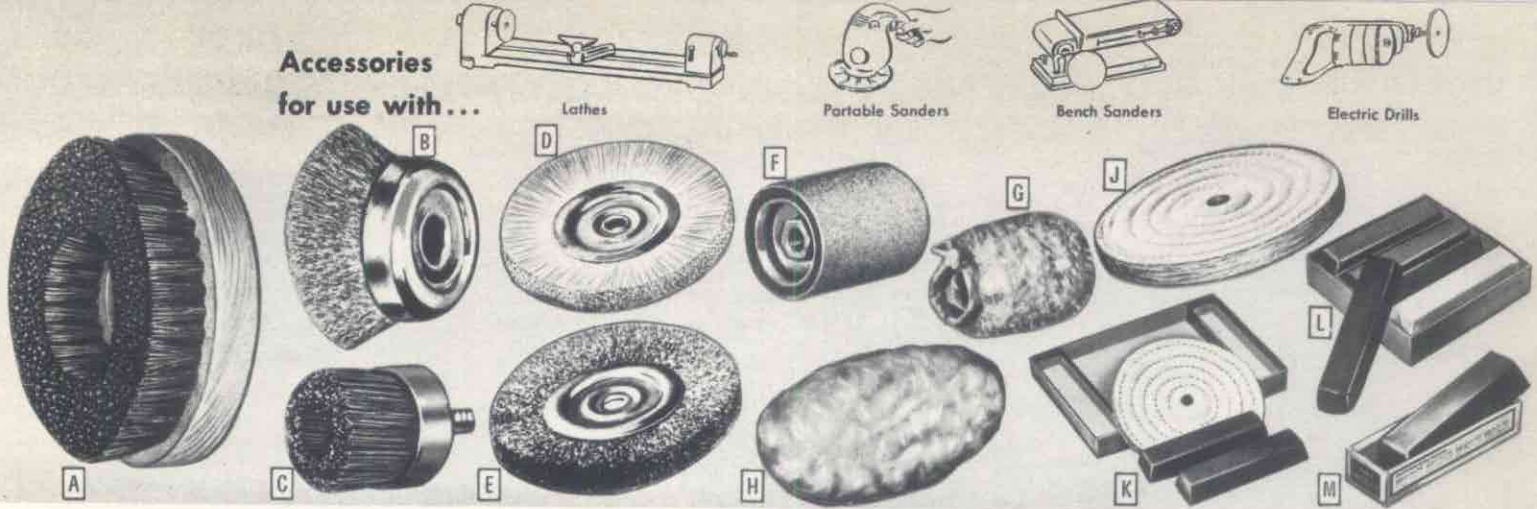

Accessories for Lathes, Sanders, Polishing Heads...

A Floor Brush. Handy for scrubbing, waxing, etc. 1-in. long Tampico fibers securely set in 6-in. diam. hardwood block. 1/2-in. arbor hole. Shpg. wt. 11 oz.
9 A 6487.....\$1.00

B Wire Cup Brush. Special crimped steel wire bristles, 1 1/2 in. long, secured in metal holder. For removing scale, rust, paint or weld spatter from rough metal surfaces. Brushing surface has 1 1/2-in. face, 2 3/4-in. outside diam.; 1/2-in. arbor hole. Shipping weight 4 ounces.
9 A 6485.....70c

C Carbon Removing Brush. Used by auto mechanics for hard-to-get-at jobs such as carbon removing, brushing motor parts, engine heads, etc. 1-in. long tempered steel wires secured in metal holder. Ferrule diam. 1 in. 1/4-in. diam. steel shank. Shipping weight 4 oz.
9 A 6484.....65c

D Tampico Fiber Wheel Brush. Tampico fiber secured by metal center. 6-inch diameter 3/8-inch face. 1/2-inch arbor hole. Shipping wt. 8 oz.
9 A 6486.....65c

E Steel Wire Wheel Brushes. Crimped steel wire; metal center. Coarse made from No. 33 wire; fine from .006-in. diam. wire; heavy duty from No. 33 wire. Order by catalog number, stating wheel diameter and arbor hole size.

Diam.	Face Width	Center Hole	Shpg. wt.	Each
-------	------------	-------------	-----------	------

9 A 6480—Coarse.

4 in.	7/16 in.	1/2 in.	5 oz.	\$0.48
6 in.	9/16 in.	3/4 in.	11 oz.	.65
8 in.	1 1/16 in.	1 1/2 in.	1 lb.	.85

9 A 6482—Fine.

4 in.	3/8 in.	1/2 in.	5 oz.	\$0.62
6 in.	1/2 in.	3/4 in.	11 oz.	.85
8 in.	5/8 in.	1 1/2 in.	1 lb.	1.10

9 A 6483—Heavy duty.

4 in.	1 in.	1 1/2 in.	14 oz.	\$1.50
6 in.	1 1/8 in.	1 3/4 in.	1 lb. 12 oz.	2.10
6 in.	1 3/8 in.	1 3/4 in.	1 lb. 12 oz.	2.10
8 in.	1 3/8 in.	1 3/4 in.	2 lbs. 12 oz.	2.60
8 in.	1 3/8 in.	1 3/4 in.	2 lbs. 12 oz.	2.60

F Sanding Drums. Complete with adapter and medium grit sleeve. Diameter 2 1/4 in.; length 3 in. Fits 1/2-in. x 20-thread shaft.
9 A 2524—Shipping weight 12 oz.\$1.25

Replacement Sanding Sleeve. (Not shown.) For above. State grit: fine, medium, coarse.
9 A 2522—Shipping weight 2 oz.14c

G Lambswool Polishing Drum. 1-in. pile. Diam. 2 1/4 in.; length 3 in. Slips over sanding drum above; polishes curved and irregular surfaces.
9 A 2533—Shipping weight 3 oz.70c

H Lambswool Polishing Bonnets. Fit over sanding plates. For polishing wax surfaces. Shpg. wt. 8 oz.
9 A 2527—7-in. diam. Fits over 5 1/2 or 6-in. sanding plate. 1-in. pile.Each 95c

9 A 2528—8-in. diam. Fits over 7-in. sanding plate. 1 1/2-in. pile.Each \$1.10

9 A 2539—9-in. diam. Fits over 8-in. sanding plate. 1 1/2-inch pile.Each \$1.40

J CRAFTSMAN Spiral-sewn Buffs. Highest quality. Full disc muslin. High thread count. 1/2-in. center hole. State diameter.

Catalog No.	Diam.	Layers	Shp. wt.	Each
9 A 6491	4 in.	18	2 oz.	\$0.23
Single Thickness Buffs	6 in.	18	3 oz.	.38
	8 in.	18	6 oz.	.52
9 A 6493	4 in.	32	2 oz.	.37
Double Thickness Buffs	6 in.	32	6 oz.	.56
	8 in.	32	11 oz.	.85

CRAFTSMAN Loose Buffs. (Not shown.) 1/2-in. center hole. Rows of sewing indicated are concentric. Easily removed. Use on bare metals, plastics and plated surfaces to give light cut and high finish. State diameter.

Catalog number	Diameter	Rows of Sewing	Layers	Shpg. wt.	Each
9 A 6494	4 in.	2	32	2 oz.	\$0.35
	6 in.	2	32	4 oz.	.52
	8 in.	3	32	7 oz.	.82

K CRAFTSMAN Buffing Set. For 1/2-in. shafts. 6-in. double-thick muslin buffing wheel; 6-oz. bar Rouge and 5-oz. bar Tripoli (brown) buffing compounds.
9 A 2864—Shpg. wt. 1 lb. 1 oz.Set 82c

L CRAFTSMAN Buffing Compound Set. One 5-oz. bar each of Emery (black), Tripoli (brown), Red Rouge and White Rouge.
9 A 2896—Shpg. wt. 2 lbs.4 bars for 55c

CRAFTSMAN 5-oz. Buffing Compound Bars.
9 A 2860—White Rouge. Shpg. wt. 8 oz.17c
9 A 2865—All Purpose. Shpg. wt. 8 oz.17c

M CRAFTSMAN Economy-size Buffing Compound Bars. 7 1/2 x 2 1/4 x 1 1/4 inches.
9 A 2874—Red Rouge. 19-oz. bar. For soft metals. Shpg. wt. 2 lbs.52c
9 A 2872—White Rouge. 19-oz. bar. For hard metals. Shpg. wt. 1 lb. 8 oz.40c
9 A 2868—All Purpose. 1-lb. bar. For plastics, most metals. Shpg. wt. 1 lb. 4 oz.45c

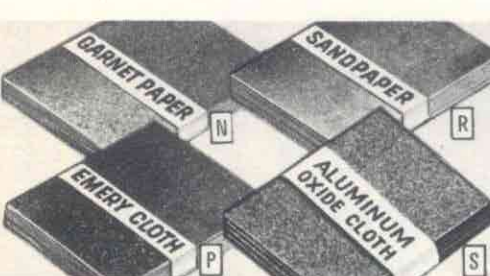

GRIT CHART

Grade	Approx. Grit	Flint or Sandpaper	Garnet Paper	Emery Cloth	Alum. Oxide Cloth
Extra fine	.150	2/0	4/0	2/0	
Fine	.120	1/0	3/0		3/0
Medium fine	.100	1/2	2/0	0	2/0
Medium	.80		0	1	0
Medium coarse	.60	1 1/2	1/2		1/2
Coarse	.40	2	1 1/2		

Grits of Abrasive Papers and their Uses

- Use coarse, medium coarse and medium grit for fast removal of material.
- Use medium-fine and fine grit for semi-finishing and light removal of material.
- Use extra-fine grit for finishing, polishing.

N Garnet Paper. 9 x 11-inch sheets. Tough; outlasts sandpaper.
9 A 6795—State grit and size package wanted.

Grit	Shpg. wt. of 6	6 for	72 for
4/0 Extra fine	4 ounces	\$0.30	\$3.45
3/0 Fine	4 ounces	.30	3.45
2/0 Medium fine	5 ounces	.30	3.45
0 Medium	6 ounces	.33	3.75
1/2 Medium coarse	7 ounces	.39	4.45
1 1/2 Coarse	8 ounces	.49	5.45

New! Wet or Dry Garnet Paper. Can be used dry or with water or rubbing oil to produce a professional finish on wood or metal. Folds without cracking.
9 A 3018—9x11-inch sheets. Please state grit.

Grit	6/0 Super fine	4/0 Extra fine	2/0 Medium fine
Shpg. wt.	3 oz.	3 oz.	3 oz.
6 for	24c	33c	37c

9 A 3006—Assorted Grits. 4 1/2 x 5 1/2-in. sheets. Shpg. wt. 2 oz. One package (10 sheets).....29c

P Emery Cloth. Package of 6 sheets; 4 3/4 x 5 1/4 inches; assorted grits. Shpg. wt. 3 oz.
9 A 6799—One package for9c
9 A 6798—3 sheets; 9x11 inches. Choice of 2/0, 3/0, or 1 grit. Please state grit when ordering. Shpg. wt. 3 oz. 3 for.29c

R Sandpaper. 4 1/2 x 5-inch sheets. 20 sheets per pkg. Assorted grits. Shpg. wt. 6 oz.
9 A 6794—One package for9c

9x10-inch sheets. Sold only in units of 12 or 120 sheets.
9 A 6793—State grit, and quantity of sheets wanted when ordering.

Grit	Shpg. wt. of 12		12 for	120 for
	lbs.	oz.		
00 Extra fine	8	17	\$1.59	
0 Fine	8	17	1.59	
1/2 Med. fine	9	19	1.79	
1 Medium	10	19	1.79	
1 1/2 Med. coarse	11	21	1.98	
2 Coarse	1	23	2.19	



S Aluminum Oxide Cloth. 9x11-inch sheets. Toughest abrasive known.
9 A 6789—State grit and size package.

Grit	Shpg. wt. of 3	3 for	24 for
3/0 Fine	6 oz.	43c	\$3.15
2/0 Med. fine	6 oz.	43c	3.15
0 Medium	6 oz.	49c	3.65
1/2 Med. coarse	6 oz.	49c	3.65

T DUNLAP Sanding Block. Curved to fit the hand. With 30x1 1/4-in. roll of medium grit garnet paper. Pull out new section as sanding cloth wears out.
9 A 3681—Shipping wt. 12 oz.75c
9 A 3688—Sanding Block Refills. 30x1 1/4-in. rolls. Medium grit. Shipping weight 3 oz. 3 rolls.27c

High quality Steel Wool. In rolls or pads. Grades: 0-fine; 1-medium fine; 2-medium; 3-coarse. State grade.
9 A 6791—Pkg. of 16 pads. Shpg. wt. 1 lb. 4 oz.29c
9 A 6787—1-pound roll. Shpg. wt. 1 lb. 4 oz.29c

W CRAFTSMAN Shop Rolls. Strong cloth back, aluminum oxide abrasive lasting. Sold in 10-yard rolls only; you cut to any length desired. For wood or metal finishing. Order by catalog number; state grit.

9 A 6431—1 inch wide

Grit	Shipping weight	10-yd. roll
Fine	7 ounces	\$0.85
Medium	7 ounces	.95
Coarse	10 ounces	1.05

9 A 6433—1 1/2-inch wide

Grit	Shipping weight	10-yd. roll
Fine	7 ounces	\$1.23
Medium	10 ounces	1.39
Coarse	13 ounces	1.63

X Liquid Glue. Use for wood, leather, glass, etc. Ready to use.
9 A 8089—4-oz. bottle. Shipping weight 14 ounces.27c
9 A 8082—8-oz. bottle. Shipping weight 1 lb. 4 oz.49c

Y Casein Powder Glue. Makes a stronger bond than ordinary glue. Simply mix with water. Fine for use where dampness occurs. 11-oz. can.
9 A 8092—Shpg. wt. 1 lb. 4 oz.75c

See inside front cover for all the details on Sears Easy Terms



Flexible Shafts



Bench Grinders



Polishing Heads

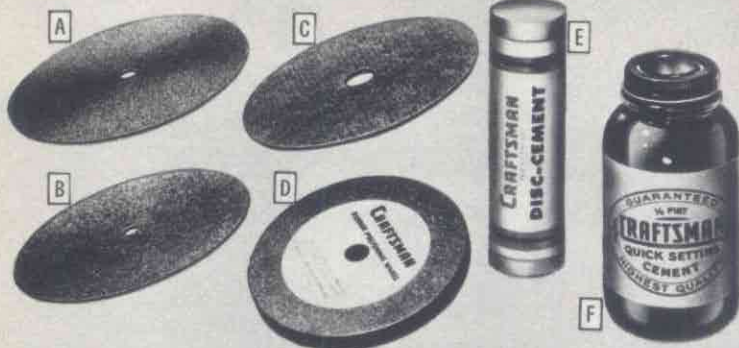

Flexible Shafts, Grinders, etc.

A Aluminum oxide abrasive rubber-bonded Cut-off Wheels. 8-in. diam. by $\frac{3}{32}$ in. thick. For $\frac{1}{8}$, $\frac{3}{16}$ or $\frac{1}{4}$ -in. shaft. 9 A 6470—State shaft. Shpg. wt. 1 lb. . . . **98c**

B New Resinoid-Bonded Cut-Off Wheels. 8-in. diam., $\frac{3}{32}$ in. thick. For $\frac{1}{8}$, $\frac{3}{16}$ or $\frac{1}{4}$ -in. shaft. State shaft diameter.

9 A 6448—For steel sheets of tubing, etc. (aluminum oxide). Shpg. wt. 1 lb. Each. **\$1.19**
9 A 6449—For tile, porcelain, etc. (silicon carbide). Shpg. wt. 1 lb. Each. **\$1.39**
9 A 6455—For cast iron, brick, concrete, etc. (silicon carbide). Shipping weight 1 pound. Each. . . . **\$1.39**

C Bayflex Abrasive Wheels. Safest all purpose grinding wheel made. Cotton felted, aluminum oxide impregnated and resinoid bonded. Replace hack saw, file, sharpening wheel or circular saw. 1-in. hole. Bushings furnished for smaller shafts.

9 A 6428—State diameter, grit and hole size

Diam.	Thickness	R.P.M.	Grit	Shpg. wt.	Each
6 in.	$\frac{1}{16}$ in.	10,000	120	8 oz.	\$1.43
6 in.	$\frac{3}{32}$ in.	10,000	80	12 oz.	1.75
6 in.	$\frac{1}{8}$ in.	10,000	24	1 lb.	2.10
7 in.	$\frac{1}{16}$ in.	8,500	120	12 oz.	1.85
7 in.	$\frac{3}{32}$ in.	8,500	80	1 lb.	2.25
7 in.	$\frac{1}{8}$ in.	8,500	24	1 lb. 8 oz.	2.69
8 in.	$\frac{1}{16}$ in.	7,500	120	1 lb.	2.29
8 in.	$\frac{3}{32}$ in.	7,500	80	1 lb. 4 oz.	2.85
8 in.	$\frac{1}{8}$ in.	7,500	24	1 lb. 8 oz.	3.39
10 in.	$\frac{1}{16}$ in.	6,000	24	2 lbs.	5.25
10 in.	$\frac{3}{32}$ in.	6,000	24	3 lbs.	8.45

D CRAFTSMAN Rubber Polishing Wheel. Made of rubber with the cutting abrasive distributed through it! For polishing and finishing all hard metals and plastics. Easy to shape for getting into difficult places. Ideal for rust removal, die work, deburring, putting a super-keen edge on knives, etc. $\frac{3}{4}$ -inch thick; $\frac{1}{2}$ -inch bore. Maximum speed recommended: 4-inch, 3800 R.P.M.; 6-inch, 2500 R.P.M. Choice of fine, medium or coarse grit. Please be sure to state grit wanted when ordering.

9 A 2928—4-inch diameter. Shipping weight 9 ounces. . . . **88c**
9 A 2929—6-inch diameter. Shipping weight 1 lb. 8 oz. . . . **\$1.60**

E Disc Cement. Holds sanding discs firmly to metal or wood sanding plates. Non-drying type. Choice of $4\frac{3}{4}$ or 16-oz. sticks.

9 A 2219— $4\frac{3}{4}$ oz. Shpg. wt. 6 oz. **29c**
9 A 2229—16 oz. Shipping weight 1 pound 2 ounces. . . . **62c**

F Cement. Fastens abrasive discs to metal plates. Sets quickly and holds very firm. Shipping weight 1 pound 2 ounces.

9 A 2535— $\frac{1}{2}$ -pint **45c**

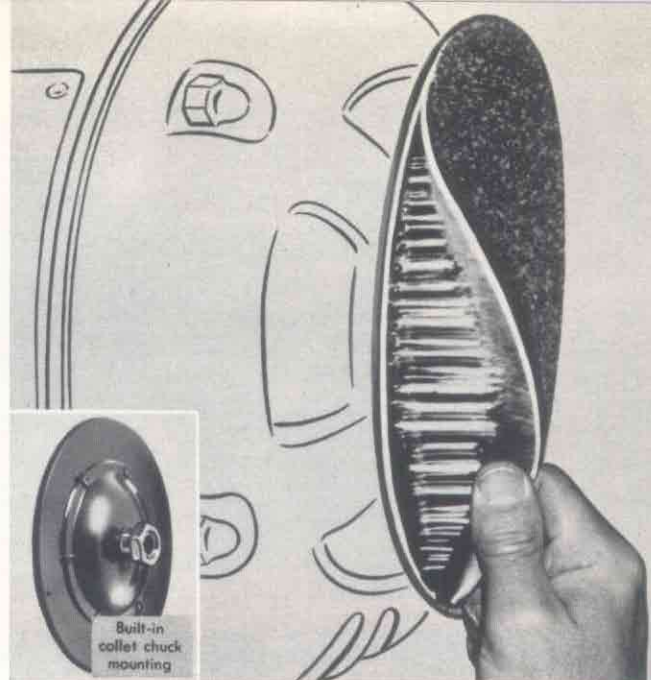

Quick-change Sanding Plate

Read the features below and you'll understand why these amazing NEW CRAFTSMAN Quick-change Sanding Plates have become so popular . . . how they will help you save time and do better work while grinding, sanding or polishing wood, metal or plastic.

The abrasive discs are pre-glued with a non-setting glue which permits instant change and immediate use of proper grit for the job at hand. No mess gluing . . . No fuss . . . No bother! Just remove old discs and replace with new one. The old disc can be replaced later without regluing.

Rubber cushion backing with resilient cutting action reduces "loading" of abrasive . . . gives cleaner, more accurate cutting . . . increases length of abrasive life . . . cuts faster and cooler with minimum possibilities of burning.

Built-in collet chuck mounting grips shaft all the way around . . . fits any $\frac{1}{2}$ -inch shaft or spindle, either plain or threaded without spoiling or marring threads. Quick, simple, secure . . . no fussing to get abrasive in place.

All-steel 7-inch diameter plate will not fracture. Non-setting adhesive holds self-centering abrasive firmly and positively.

Perfect for sanding, grinding or polishing wood, metal or plastic. Comes complete with one medium grit disc.

9 A 2549—Shipping weight 2 pounds. . . . **\$1.98**
9 A 2546—Replacement Abrasive Discs for above. Choice of fine, medium or coarse grit. State grit wanted when ordering. Shpg. wt. 5 oz. . . . Pair **45c**



G Sanding Belts. Endless construction. For sanding wood or metal. Choice of fine, medium or coarse grit. Please state grit wanted.

9 A 2167— $6 \times 48 \times \frac{3}{16}$ inches. Aluminum oxide on cloth. Fits 99 AM 2728 sander (see page 9). Shpg. wt. 8 oz. . . . **\$1.05**
9 A 2211— $4 \times 52 \times \frac{1}{2}$ inches. Aluminum oxide on cloth. Fits Sears former No. 2210 sander. Shpg. wt. 10 oz. **75c**
9 A 2215— 4×36 inches. Aluminum oxide on cloth. Fits Sears former No. 2213 sander. Shpg. wt. 4 oz. . . . **58c**

H 7-inch Resin-bonded Abrasive Discs. $\frac{1}{2}$ -inch center hole. Out-last glue-bonded discs from 2 to 2 $\frac{1}{2}$ times! Won't "soften up" under high speeds. Fine for curved surfaces. Made of aluminum oxide grit, firmly bonded to pliable fiber back. Your choice of following grits: No. 24, 36, 50 or 80. Please state grit wanted.

9 A 2220—Shpg. wt. 5 oz. Each. **30c**
J 7-inch Fiber Backing Pads. Used for backing up abrasive discs for more rigidity. Please state $\frac{1}{2}$ -inch center hole when ordering.
9 A 2225—Shpg. wt. 4 oz. Each **55c**

K Replacement Abrasive Sanding Discs. Made of aluminum oxide on paper. Ideal for sanding either wood or metal. Six discs of same grit size in package. Choice of fine, medium, or coarse grit. State grit size wanted.

9 A 2532—6-inch diameter. Shipping weight for package of six, 6 ounces.
Package of 6 fine grit for. . . . **25c**
Package of 6 medium grit for. . . . **28c**
Package of 6 coarse grit for. . . . **35c**

L 9 A 2525—8-in. diam. Fits Sears former sander No. 2213 and 9A2341 and 9A2491 sanding plates at right. Shpg. wt. per pkg., 8 oz.
Package of 6 fine grit for. . . . **43c**
Package of 6 medium grit for. . . . **53c**
Package of 6 coarse grit for. . . . **63c**

9 A 2526—9-in. diam. Fits Sears 9A2730 sanding plate (see page 9). Shpg. wt. per pkg., 8 oz.
Package of 6 fine grit for. . . . **55c**
Package of 6 medium grit for. . . . **65c**
Package of 6 coarse grit for. . . . **80c**

9 A 2534—10-in. diam. Fits Sears former No. 2210 sander. Shpg. wt. per pkg., 10 oz.
Package of 6 fine grit for. . . . **68c**
Package of 6 medium grit for. . . . **80c**
Package of 6 coarse grit for. . . . **\$1.00**

M Sanding Plates. Cast iron construction. Set screw provided to lock plate securely on spindle. Plate has one abrasive disc for sanding wood, attached. Extra abrasive discs at left. Be sure to check spindle size.

9 A 2341—Shpg. wt. 2 lbs. . . . **\$3.10**
8-inch diameter. Fits lathe 99 AM 2307 (see page 16) or any $\frac{3}{4}$ in. x 16 right hand thread spindle.
9 A 2491—Shpg. wt. 2 lbs. 8 oz. **\$3.50**

N Sanding Wheel. 8-in. diameter. $\frac{1}{2}$ or $\frac{3}{8}$ in. bore. Steel. Fits any 8-in. or larger bench saw, having $\frac{1}{2}$ or $\frac{3}{8}$ -in. arbor. Has one medium and one coarse abrasive disc for wood, attached. State bore size.
9 A 2272—Shpg. wt. 4 lbs. . . . **\$2.50**

O Replacement Sanding Discs, for 9 A 2272 above. 8-in. diameter. 2-in. center hole fits over any arbor. Package of six assorted: 2 each of fine, medium and coarse grit.
9 A 2273—Shpg. wt. 10 oz. . . . **57c**

P Flexible Sanding Plates. Fit flexible shafts, polishing heads, lathes, electric hand drills, etc., or any other $\frac{1}{2}$ -inch 20-thread spindle. One medium grit abrasive attached. For wood or metal.

5 $\frac{1}{2}$ -inch diameter. Thick, molded flexible rubber pad, with $3\frac{1}{2}$ -inch diameter steel insert. Hub center-screw in hub keeps sanding disc from shifting.
9 A 2610—Shpg. wt. 13 oz. . . . **\$1.25**

7-inch diameter. Thick, molded flexible rubber pad, with $4\frac{3}{8}$ -inch diameter steel insert. Hub center-screw keeps sanding disc from shifting. Takes regular or resin-bonded discs at left.
9 A 2611—Shpg. wt. 1 lb. 5 oz. . . . **\$1.75**

Q Replacement Sanding Discs. For either plate described above. Medium grit abrasive. Use on wood or metal. Number 9 A 2612 replaces Sears old No. 2541; Number 9 A 2613 replaces Sears old No. 2545.

9 A 2612—5 $\frac{1}{2}$ -inch diameter. Shipping weight 2 oz. . . . Pair **25c**
9 A 2613—7-inch diameter. Shipping weight 3 oz. . . . Pair **40c**

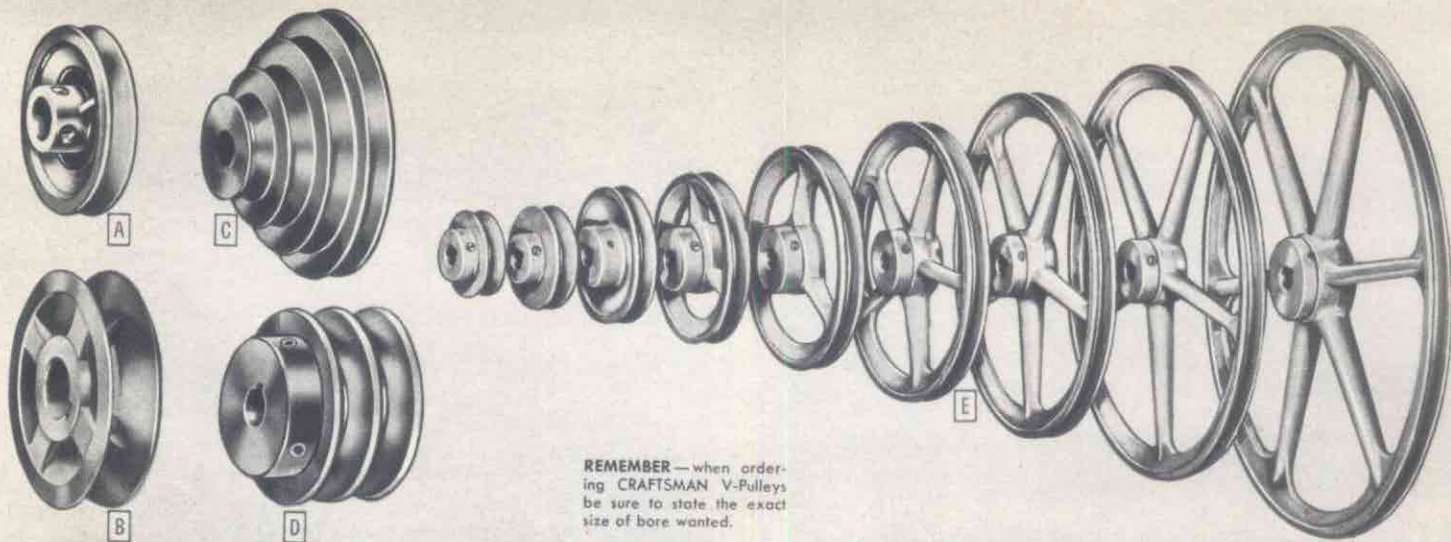

REMEMBER—when ordering CRAFTSMAN V-Pulleys be sure to state the exact size of bore wanted.

CRAFTSMAN V-Pulleys are available for most power tools

CRAFTSMAN pulleys are scientifically designed for greatest working efficiency and are carefully and accurately made to give you top working performance from your machinery or power tools. All the belt grooves are painstakingly machined to run true. All bores are reamed to exact size. Diameters given in the table listings below refer to outer edge of pulleys, not to bottom of the groove. Before ordering, carefully check diameter and bore size wanted.

CRAFTSMAN single groove V-Pulleys

A Made of tough alloy die cast metal. Strong flanges and hubs; machined grooves and reamed bores. Two slotted head, hardened setscrews insure positive locking of pulley on shaft. For $\frac{3}{8}$ -(O section) or $\frac{1}{2}$ -(A section) inch wide V-belts, except 9A2800, which is for use with $\frac{3}{8}$ -(O section) inch belt only. State bore size.

Cat. No.	Diameter	Bore, inch	Shpg. wt.	Each
9 A 2800	1½ in.	½	3 oz.	32c
9 A 2801	2 in.	¾	5 oz.	37c
9 A 2802	2½ in.	¾	6 oz.	42c
9 A 2803	3 in.	¾	7 oz.	46c
9 A 2804	4 in.	¾	10 oz.	60c
9 A 2805	5 in.	¾	15 oz.	78c
9 A 2806	6½ in.	¾	1 lb. 6 oz.	\$1.20

CRAFTSMAN hubless V-Pulleys

B Permit use of pulleys side by side for multiple drives. Sturdily built of tough alloy die cast metal. Machined grooves and reamed bores. Two slotted head, hardened setscrews lock pulley on shaft. For $\frac{3}{8}$ -(O section) or $\frac{1}{2}$ -(A section) inch wide V-belts. Please state bore size wanted.

Cat. No.	Diameter	Bore	Shpg. wt.	Each
9 A 2901	2 inches	½, ¾ inch	6 ounces	44c
9 A 2902	2½ inches	¾, 1 inch	9 ounces	53c
9 A 2903	3 inches	¾, 1 inch	11 ounces	62c

CRAFTSMAN cone-type V-Pulleys

C Use in pairs for variable speed applications. Made of tough alloy die cast metal. Three and four step. Two slotted head, hardened setscrews lock pulley on shaft. For $\frac{3}{8}$ -(O section) or $\frac{1}{2}$ -(A section) inch wide V-belts. Have $\frac{1}{2}$, $\frac{3}{8}$ or $\frac{1}{4}$ -inch bore. State bore size.

Cat. No.	Size	Diam., step, in.	Shpg. wt.	Each
9 A 2788	3½ in.	3, 2½, 2	1 lb.	\$1.05
9 A 2792	4 in.	4, 3½, 2½, 2	1 lb. 10 oz.	1.30
9 A 2793	5 in.	5, 4, 3, 2	1 lb. 14 oz.	1.50

CRAFTSMAN two-groove V-Pulleys

D Made of heavy cast iron. Balanced and true running, strong enough for heavy production work. Use on electric motors or gas engines on industrial, farm, workshop or household machines. Standard keyways provided in all bores listed in table below. Two hardened, hollow head setscrews. With wrench. For V-belts $\frac{1}{2}$ (A section) or $\frac{3}{8}$ (B section) inch wide. State bore size wanted.

Cat. No.	Diameter	Bore, inch	Shpg. wt.	Each
9 A 2940	3 in.	¾, 1	2 lbs. 11 oz.	\$2.80
9 A 2941	4 in.	¾, 1	4 lbs. 1 oz.	3.50
9 A 2942	5 in.	¾, 1, 1½	4 lbs. 9 oz.	3.85
9 A 2943	6 in.	¾, 1, 1½	6 lbs. 6 oz.	4.40
9 A 2944	8 in.	1, 1½	9 lbs. 11 oz.	5.50
9 A 2945	10 in.	1, 1½	11 lbs. 8 oz.	6.40
9 A 2946	12 in.	1, 1½	13 lbs. 15 oz.	7.50

CRAFTSMAN single-groove V-Pulleys

E Made of heavy cast iron. Heavy duty for production work in the shop, household or on the farm. Use to replace single groove V-pulleys on any type electric motor or gas engine. Positive grip grooves are expertly machined and bores are accurately reamed. CRAFTSMAN single groove V-pulleys have slotted-head, hardened setscrew. Standard keyways in $\frac{3}{8}$ -inch or larger bores. The grooves fit V-belts $\frac{3}{8}$ -inch (O section) or $\frac{1}{2}$ -inch (A section) wide. Order by catalog number and please remember to state clearly the size of bore which you require.

Cat. No.	Diameter	Bore, inch	Shpg. wt.	Each
9 A 2880	1½ in.	½	9 oz.	45c
9 A 2881	2 in.	¾	11 oz.	50c
9 A 2882	2½ in.	¾	15 oz.	60c
9 A 2883	3 in.	¾	1 lb. 7 oz.	70c
9 A 2884	4 in.	¾	2 lbs. 3 oz.	95c
9 A 2885	5 in.	¾	2 lbs. 7 oz.	\$1.05
9 A 2886	6½ in.	¾	3 lbs.	1.25
9 A 2808	8 in.	¾	3 lbs. 15 oz.	1.75
9 A 2810	10 in.	¾	4 lbs. 7 oz.	1.95
9 A 2812	12 in.	¾	5 lbs. 11 oz.	2.50
9 A 2814	15 in.	¾	9 lbs. 11 oz.	4.85

How to figure pulley diameter for engine. Multiply diameter of driven pulley by speed (R.P.M.) of driven machine. Divide result by the speed (R.P.M.) of engine. Result is diam. of engine pulley.

How to figure machine pulley diameter. Multiply diam. of engine pulley by speed (R.P.M.) of engine. Divide result by speed (R.P.M.) at which driven machine will run. Result is diam. of machine pulley.

Table of Pulley Speeds

Use this table to determine the speed of your machine with varying sizes of motor and machine pulleys. Figures given are for use with belt at proper tension and a standard motor speed of 1750 R.P.M.

Diam. of Driving or Motor Pulley	Diameter in inches of Machine or Driven Pulley				
	1½	2	2½	3	4
1½ inches	1725	1290	1030	860	645
2 inches	2300	1725	1380	1150	860
2½ inches	2890	2160	1725	1440	1080
3 inches	3450	2590	2070	1725	1290
4 inches	4600	3450	2760	2300	1725
5 inches	5750	4310	3450	2870	2160
6½ inches	7460	5600	4490	3740	2800

EXAMPLE—the machine has a 2-in. pulley and should run 3450 or 3500 R.P.M. What size pulley should be used with a 1750 R.P.M. motor? From the above table, follow down the vertical 2-in. column to the speed of 3450, then to the left in column headed "Diameter of Driving or Motor Pulley." The answer is a 4-inch diameter pulley is required.

CRAFTSMAN Pulley Remover

Gives a snug and evenly distributed non-slip grip

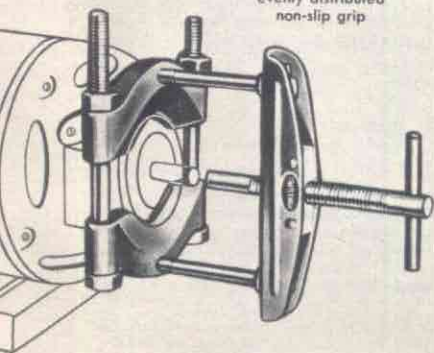

\$285 Professional quality. An excellent sheave and pulley remover for removing small V-drive pulleys when frozen fast on electric motors or other power tool shafts and for removing single or multiple drive sheaves.

Fits single or multiple groove pulleys, gears, bearings, etc. Eliminates the need for pulling on outer flange. So simple and easy to operate. Just clamp down in V-groove of sheave or pulley . . . the pulling strain is evenly distributed around a great part of the circumference. Gives a positive non-slip grip. Has capacity of 1¼ to 4½ inches. Strong steel construction.

A very handy tool for the home workshop or for the man who does set-up and mechanical repair work . . . perfect for solving many service and maintenance problems.

9 A 4696—Shpg. wt. 4 lbs. . . . \$2.85

Buy NOW! Buy the BEST! See inside front cover for Easy Terms

Hollow-head Setscrews, Wrenches

F Hollow-head Setscrews. Take the place of ordinary setscrews. Can be screwed down flush with the surface. Made of tough alloy steel. Shipping weight each 2 ounces.

9 A 2809—Please state diameter and length.

Diameter	Length	Threads to in.	Each
¼ inch	¼ inch	20	5c
¼ inch	½ inch	20	5c
¼ inch	¾ inch	20	5c
¼ inch	1 inch	18	5c
¼ inch	1½ inch	18	5c
¼ inch	2 inch	16	5c

G 9-piece Allen Wrench Set. For above setscrews. In convenient plastic holder. Fit Allen setscrews No. 4, No. 6, No. 8, No. 10, and ¼, ⅜, ½, ⅝, ¾, 1 inch. Made of hardened and tempered tool steel. Shipping weight 10 oz.

9 A 2807 Set 98c

9 A 2813—Individual sizes. Please be sure to state size wanted. Shpg. wt. each 1 oz.

For ¼-inch screw	9c
For ⅜-inch screw	9c
For ½-inch screw	9c
For ⅝-inch screw	9c
For ¾-inch screw	9c

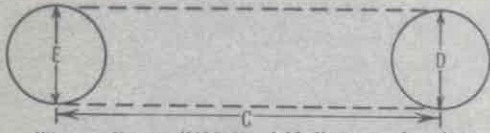
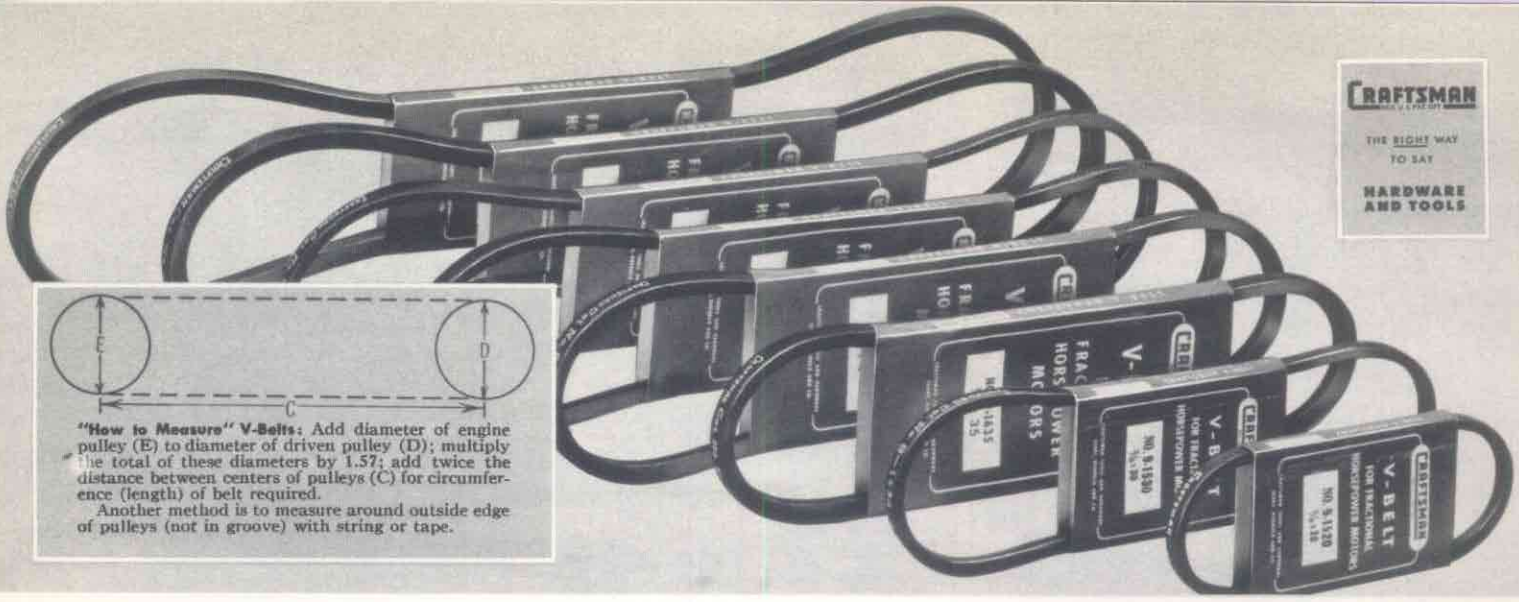

"How to Measure" V-Belts: Add diameter of engine pulley (E) to diameter of driven pulley (D); multiply the total of these diameters by 1.57; add twice the distance between centers of pulleys (C) for circumference (length) of belt required.
Another method is to measure around outside edge of pulleys (not in groove) with string or tape.

More pulling power, less frictional loss with **CRAFTSMAN V-Belts**

CRAFTSMAN V-belts are highest quality . . . expertly made from the finest materials available in order to give you the utmost in satisfaction. Each belt has an extra

heavy, closely woven cotton jacket wrapped around pliable, heat-resistant rubber. Reinforcing cords are pre-treated in liquid rubber.



3/8-inch V-Belts

CRAFTSMAN quality. Correct size for use on drives over small diameter pulleys. See "How to Measure" above.



1/2-inch V-Belts . . . for most applications with V-pulleys

Genuine CRAFTSMAN quality. The correct size for most applications with V-pulleys, 2 inches in diameter or larger. Gives positive non-slip grip along sides of V-pulley grooves. Be sure to order correct size V-belt. See "How to Measure" above.

Why not replace your worn-out V-belt with a long-wearing, true-running CRAFTSMAN V-belt today . . . you'll speed up production and cut costs immediately.

Cat. No.	Length	Shpg. wt.	Each
9 A 1520	20 in.	4 oz.	43c
9 A 1522	22 in.	4 oz.	44c
9 A 1524	24 in.	4 oz.	45c
9 A 1526	26 in.	4 oz.	47c
9 A 1528	28 in.	4 oz.	49c
9 A 1530	30 in.	4 oz.	51c
9 A 1532	32 in.	4 oz.	54c
9 A 1534	34 in.	4 oz.	56c
9 A 1536	36 in.	4 oz.	59c
9 A 1538	38 in.	4 oz.	61c

Catalog Number	Length	Shipping weight	Each
9 A 1622	22 in.	4 oz.	45c
9 A 1624	24 in.	4 oz.	46c
9 A 1625	25 in.	4 oz.	47c
9 A 1626	26 in.	4 oz.	48c
9 A 1628	28 in.	4 oz.	50c
9 A 1629	29 in.	4 oz.	51c
9 A 1630	30 in.	5 oz.	52c
9 A 1631	31 in.	5 oz.	53c
9 A 1632	32 in.	5 oz.	55c
9 A 1633	33 in.	5 oz.	56c
9 A 1634	34 in.	6 oz.	57c
9 A 1635	35 in.	6 oz.	59c
9 A 1636	36 in.	6 oz.	60c
9 A 1637	37 in.	6 oz.	61c
9 A 1638	38 in.	7 oz.	63c
9 A 1639	39 in.	7 oz.	64c
9 A 1640	40 in.	7 oz.	65c
9 A 1641	41 in.	7 oz.	67c
9 A 1642	42 in.	7 oz.	70c

Catalog Number	Length	Shipping weight	Each
9 A 1643	43 in.	7 oz.	71c
9 A 1644	44 in.	7 oz.	73c
9 A 1645	45 in.	7 oz.	74c
9 A 1646	46 in.	7 oz.	75c
9 A 1647	47 in.	7 oz.	76c
9 A 1648	48 in.	7 oz.	77c
9 A 1650	50 in.	7 oz.	81c
9 A 1651	51 in.	7 oz.	82c
9 A 1652	52 in.	7 oz.	83c
9 A 1654	54 in.	7 oz.	86c
9 A 1656	56 in.	8 oz.	89c
9 A 1658	58 in.	8 oz.	93c
9 A 1660	60 in.	8 oz.	95c
9 A 1662	62 in.	8 oz.	98c
9 A 1664	64 in.	8 oz.	\$1.03
9 A 1666	66 in.	9 oz.	1.05
9 A 1684	84 in.	10 oz.	1.28
9 A 16100	100 in.	11 oz.	1.49

EASY TERMS

It's easy to buy the power tools and accessories you need in one order . . . use Sears Easy Terms Payment Plan. See inside front cover for complete details.

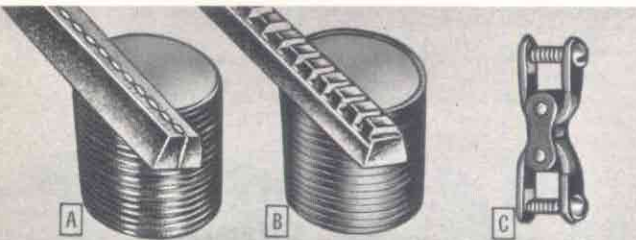

Leather V-Belting . . . Wire Hooks . . . Couplers

A Leather V-Belting. Use this fractional horsepower plain leather V-belting for rapid replacement on your power tools and other machines. No need to remove machinery to replace belt. Made of two thick plies of tough oak-tanned leather cemented together and then sewn down the center. Steel wire hook is included with every length.

9 A 2777—Be sure to state width and length wanted.

3/8-inch width. Shipping weight per foot 3 oz. . . . Per inch **2c**

1/2-inch width. Shipping weight per foot 4 oz. . . . Per inch **3c**

3/4-inch width. Shipping weight per foot 5 oz. . . . Per inch **3½c**

Wire V-Belt Hooks. (Not shown.) Simple to use. Connect leather V-belt sections by punching holes into belt, inserting hook and clinching. That's all there is to it when you use these convenient wire V-belt hooks. Made of tough steel music wire. Makes a safe, dependable connection. Shipping weight of six 1 oz.

9 A 2847—State size wanted. Small size. For 3/8 or 1/2-inch belt. Each **1c**

Large size. For 3/4 or 3/8-inch belt. Each **1c**

B Notched V-Belting. Made of tough, strong, oak-tanned leather. Fine grade of leather and expert tanning make this belting extremely flexible. Notches cut crosswise in under surface. Gives belt greater flexing ability and more positive, non-slip-grip contact with pulleys. Ideal for fractional horsepower drives. Steel wire hook is included with every length. Be sure to measure carefully length around outside of pulleys (not in grooves) to determine length needed.

9 A 2778—State length and width.

1/2-inch width. Shipping weight per foot 3 oz. . . . Per inch **3c**

3/4-inch width. Shipping weight per foot 4 oz. . . . Per inch **4½c**

9 A 2779—3/8-inch oak-tanned leather V-belting. Similar to above but not notched. Shipping weight per foot 3 ounces. . . . Per inch **2c**

C V-Belt Couplers. Here's the ideal way to shorten old leather V-belts or to couple together new ones. Coupler consists of roller chain link between two bails. Will not cause additional vibration. So simple and easy to install. Use for 3/4, 1/2 or 3/8-in. V-belting.

9 A 2842—Shpg. wt. 1 oz. . . . **25c**

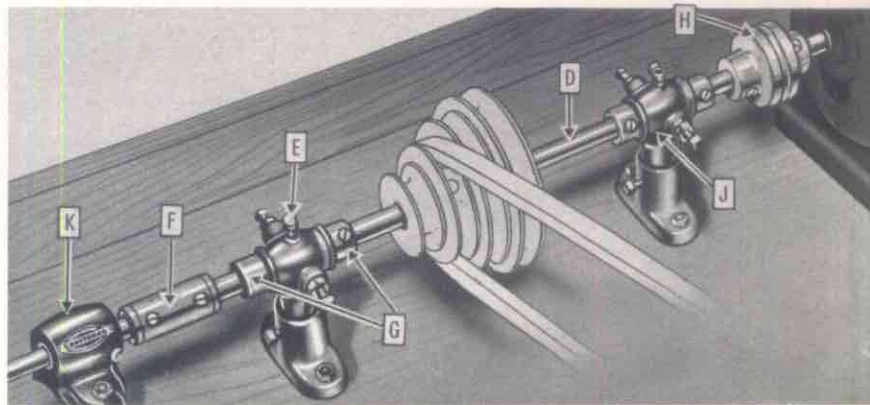

Line Shaft and Line Shaft Accessories

Use 1/2-in. line shaft for light tools, 3/4 and 3/8-in. line shaft for heavier machines and larger motors. Oil cups easily installed in place of plugs. Rigid couplings often used to connect sections of line shafting. Line shaft collars prevent end-wise "drift" of shaft. Flexible couplings used to connect motor shaft to line shaft; self-adjusting for slight misalignment. Bronze bearing hangers adjustable for perfect shaft alignment. 1/2-in. hangers should be spaced every 18 in.; 3/4-in. hangers every 24 in. Pillow blocks are used as end supports for shafts.

We recommend a 1/2-H.P. motor or larger to drive tools from a line shaft.

Catalog Number		Shpg. wt.	Each
(D) 9 A 2833	1/2-inch x 24-inch Steel Shaft	1 lb. 15 oz.	\$0.48
99 A 02834	1/2-inch x 48-inch Steel Shaft	3 lbs.	.74
99 A 02830	3/8-inch x 48-inch Steel Shaft	5 lbs.	.95
99 A 02835	3/4-inch x 48-inch Steel Shaft	7 lbs.	1.25
(E) 9 A 2820	Oil Cups	1 oz.	.07
(F) 9 A 2839	1/2-inch Rigid Coupling	5 oz.	.30
(G) 9 A 2824	1/2-inch Line Shaft Collar	2 oz.	.12
9 A 2825	3/4-inch Line Shaft Collar	3 oz.	.18
(H) 9 A 2840	Flexible Coupling (Specify 1/2, 3/4 or 3/8-inch)	12 oz.	.53
(I) 9 A 2828	1/2-inch Bronze bearing Shaft Hanger	1 lb. 8 oz.	1.45
9 A 2829	3/4-inch Bronze bearing Shaft Hanger	1 lb. 12 oz.	1.85
(K) 9 A 2716	1/2-inch Pillow Block	1 lb. 8 oz.	1.20
9 A 2717	3/8-inch Pillow Block	1 lb. 8 oz.	1.20
9 A 2718	3/4-inch Pillow Block	1 lb. 8 oz.	1.20

"I've already saved myself \$800 with my CRAFTSMAN Arc Welder"

writes IRVIN SUTTON of Carlock, Ill.

Dear Sirs: I estimate I've already saved myself \$800 in repair bills, in the 4 years I have used my CRAFTSMAN Arc Welder, and averaged over \$100 a year doing work for my neighbors. I had no previous experience in welding and yet by the end of the first month I had made a bulldozer for my tractor, a rear end manure loader, and changed my 4-wheel manure spreader into a 2-wheel

spreader for tractor use. I use my welder for hard facing plow shares; preheating iron; for bending; brazing; soldering; and cutting iron even as large as 4-inch bar stock. My welder paid for itself the first 4 months I had it. Two of my neighbors have bought welders from you after seeing how easy it was to weld with mine.

Irvin Sutton



CRAFTSMAN Industrial A. C. Electric Arc Welders

- CRAFTSMAN Electric Arc Welders are tested and approved by Underwriters' Laboratories, Inc. for safety, freedom from fire hazard and temperature rise limits.
- Coils insulated with sensational spun glass insulation . . . dipped in varnish, then baked. Makes it practically impossible to burn out welder if used on correct current supply (220-230 volts).
- Fire-resistant all-metal cabinets with control panels fully protected against dust and dirt.
- Built-in reactance helps maintain steady arc; automatically increases voltage on low heats.
- Transformer has high power factor for greater efficiency and reduced current consumption.
- Complete range of current outlets allows wide variety of work. Cuts, brazes, solders and welds metals of all thicknesses. Even more versatile if used with Twin Carbon Torch 9A2007, below.

\$19900
CASH
99 AM 2015
\$20.00 DOWN

Maximum heat at arc with minimum current consumption! Natural draft cooling . . . no fans. Approved code-type on-off switches. Sturdy steel feet in front; large wheels in rear. Stub wire leads for A.C. connection. With 5 lbs. assorted welding electrodes, wire brush, carbon electrode, electrode holder, two 15-ft. cables, welding helmet, and illustrated manual (9 A 2025 described on opposite page). For use on single phase, 220-230 volt, 60-cycle A.C. only. Be sure to check voltage, cycle, phase, and capacity of your power line with your local power company before ordering.

SPECIFICATIONS:	99 AM 2015	99 AM 2012
• Maximum amperes actual welding current delivered...	300 amperes	200 amperes
• Welding heats available (actual welding current)	Thirty; 20 to 300 amps.	Eighteen; 20 to 200 amps.
• Maximum rod size	3/8 inch	3/16 inch
• Type of service	Continuous	Continuous
• Current supply required	Single phase 220-230 volt A.C.	Single phase 220-230 volt A.C.
• Maximum open circuit secondary volts	94 volts	94 volts
• Maximum line draw	65 amperes	48.5 amperes
• Maximum kilowatts	8.2 kilowatts	6.2 kilowatts
• Maximum kilo-volt-amperes	14.3	10.7
• Cabinet dimensions, Height	37 inches	33 inches
Width	23 inches	20 inches
Depth	21 inches	21 inches
99 AM 2015—Shipping weight 336 pounds		\$199.00
99 AM 2012—Shipping weight 260 pounds		149.00

Illustrated Arc Welder Manual included with CRAFTSMAN Arc Welders.

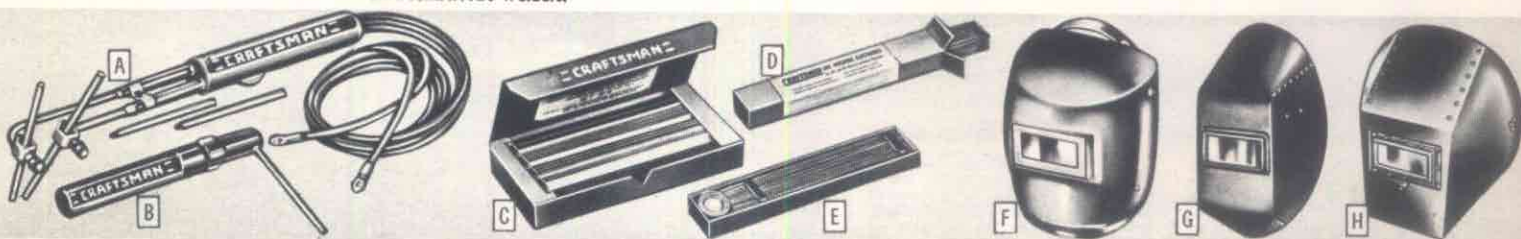

Welders' Supplies . . . Twin Carbon Torch . . . Electrodes

A CRAFTSMAN Twin Carbon Torch. Industrial type. Increases usefulness of your welder. For brazing, soldering, heating, etc., on A.C. arc welders. Lightweight. Balanced. 15 3/4 inches long. With cables, carbons, instructions. Shipping weight 4 lbs. 6 oz. 9 A 2007—\$13.95

Cored Carbons. For twin torches.
9 A 2020—1/4x6 inches. Shpg. wt. 10 oz. 10c
9 A 2021—5/16x6 inches. Shpg. wt. 12 oz. 12c
9 A 2022—3/8x6 inches. Shpg. wt. 1 lb. 15c

B CRAFTSMAN Electrode Holder. Insulated. Light weight. For 300-ampere welders or smaller. 9 in. long. Shpg. wt. 1 lb. 9 A 2006—\$3.19

C 20-lb. Electrode Assortment. (About 380 rods). For use with A.C. or D.C. welders (D.C. reverse polarity). Includes: Rods for mild steel welding; 2 lbs. 3/32-in. rods, 4 1/2 lbs. 1/8-in. rods and 4 1/2 lbs. 5/32-in. rods; for cast iron welding: 4 1/2 lbs. 1/8-in. rods; for hard surfacing: 4 1/2 lbs. 1/8-in. rods. Shipping weight 22 lbs. 99 A 02024—Complete assortment. \$6.25

D CRAFTSMAN Welding Electrodes. Flux-coated for use on all A.C. or D.C. (D.C. reverse polarity) welders. 9 A 2003—For use on mild steel. State size.

Size	Shpg. wt.	1/16-in.	3/32-in.	1/8-in.	5/32-in.	3/16-in.
2 lbs. 2 lbs. 2 oz.		\$2.65				
5 lbs. 5 lbs. 12 oz.		\$1.55	\$1.25	\$1.15	\$1.15	
25 lbs. 29 lbs.		7.40	5.90	5.40	5.40	

9 A 2055—For use on cast iron. State size.
5 lbs. 5 lbs. 12 oz. \$1.65 \$1.35 \$1.19 \$1.19
25 lbs. 29 lbs. 7.90 6.40 5.80 5.60
9 A 2004—For hard surfacing use. State size.
5 lbs. 5 lbs. 12 oz. \$2.98 \$2.79 \$2.59
25 lbs. 29 lbs. 14.45 13.45 12.45

E 9 A 2002—Brazing Rod Kit. 2 pounds 1/8-in. rods. S-oz. flux. Shpg. wt. 2 lbs. 4 oz. \$3.29

Industrial Welding Helmets

F One-piece seamless vulcanized fiber construction. Our finest. Shaped to fit head contour. Fiber head band adjustable over wide range of sizes. No metal touches head. Friction joint adjustable from outside for free-floating action. Bakelite glass holder. 2x4 1/2-in. clear cover glass provided. Filter lens not included (listed and sold separately at right). 9 A 1324—Shpg. wt. 2 lbs. 6 oz. \$7.50

G Streamlined fabricated fiber construction. Has automatic spring snap for "off" and "on" positions. Black fiber headband; genuine leather sweatband. Size adjustable over wide range. No metal touches head. Convenient glass holder is readily removable. 2x4 1/2-in. clear cover glass supplied. Filter lens not included (listed and sold separately at right). 9 A 1323—Shpg. wt. 2 lbs. 9 oz. \$6.00

H Fabricated fiber construction. Adjusts to fit head size. Can be thrown back without removing from head. Friction joint between headband and helmet makes helmet readily adjustable and secure in both "on" and "off" positions. Clear cover glass and No. 10 shade filter lens provided. Both are 2x4 1/2-in. size. Note our low price! Shipping weight 2 pounds 8 ounces. 9 A 1326. \$3.75

Extra Filter Lenses and Cover Glass. (Not illustrated.) For arc welding use. Size 2x4 1/2-in. Flt almost all style helmets. Shipping weight, each, 5 ounces.
9 A 1327—No. 10 Shade Filter Lens. For 75 to 250-amp. 82c
9 A 1328—No. 12 Shade Filter Lens. For 250 amp. or over 82c
9 A 1329—Clear Cover Glass. 6c



CRAFTSMAN 150-amp. Arc Welder

- Ideal for intermittent service in farm, garage, small welding and industrial shops; operates perfectly on R.E.A. and other rural power lines.
- Approved by Underwriters' Laboratories, Inc.; meets R.E.A. and N.E.M.A. standards.

\$13500 CASH Complete! Just plug in on properly wired and fused line. Actually welds 2½ minutes out of every 10 at 150 amps.; much longer at lower ratings. 25% duty cycle... 5% more than needed. Economical. Spun glass insulation; varnished and baked. Has principal features of welders on opposite page. 33x20x21-in. metal cabinet. Uses ¼-in. rods or smaller.

\$13.50 DOWN Fifteen heats; 20 to 150 amps. actual welding current. Max. open circuit secondary volts 64; max. K.W. 4.8; max. K.V.A. 6.9. With two 15-ft. work cables; assorted electrodes; electrode holder; steel brush; helmet; 3-wire 7-ft. primary cable; polarized plug; receptacle; manual (9A2025). For single-phase, 220-230-volt 60-cycle A.C. power lines where local distribution transformer has 3 K.V.A. or greater capacity. Check voltage, phase, cycle, and capacity of your line with power company before ordering. 99 AM 2018—Shipping weight 215 lbs. **\$135.00**



Arc Welder Manual. 36 pages. Learning to weld is easy with this new instruction book. Tells how to repair broken equipment and build new devices for more efficient work. 165 illustrations, clearly and fully described. New... up-to-date. Paper bound. 9 A 2025—Shpg. wt. 3 oz. **.49c**

CRAFTSMAN 75-amp. Arc Welder

- Compact... portable... for light maintenance, body and fender shops, metalworking shops. Ideal for the farm or home workshop.
- Approved by Underwriters' Laboratories, Inc. Spun glass insulation; varnished and baked.

\$5895 CASH We believe this is one of the finest small shop arc welders ever made. Not a toy—but built to the same standards as our big industrial welders on opposite page.

\$6.00 DOWN Actually welds on all heats with standard type electrodes. 20% duty cycle for intermittent service. Just plug in on properly wired and fused (30 amp.) house or shop circuit.

Fire-resistant all-metal cabinet, 14½x12½x10 in.; controls on front. "On-off" toggle switch. Automatic voltage regulation. Natural draft cooling; no fans. Maximum rod size ¼-in. Can also be used with Twin Carbon Torch 9A2007 (not included; see opposite page).

Four heats, 30, 45, 60, 75 amps. actual welding current. Maximum open circuit secondary volts 65; maximum K.W. 2.0; maximum K.V.A. 3.0; maximum line draw 26 amps.; line draw when idle 1.5 amps. With two work cables (7-ft. ground, 9-ft. electrode cable); 6-ft. primary cable, plug, receptacle; carbon electrode; electrode holder; wire brush; 2 lbs. assorted welding rods; welder's manual (9A2025, at left). For single phase, 110-120 volt 50-60 cycle A.C. Check voltage, phase, cycle, capacity of your line with your power company. 99 AM 2011—Shpg. wt. 60 lbs. **\$58.95**

Safety Goggles, Shields, Respirators

- A** Spectacle type with wire mesh side shields for chipping, grinding; minimizes fogging. Non-corroding frame, insulated temples; heat, perspiration resistant. Hardened, ground 50-mm. lenses. 28 A 6070—Shipping weight 8 oz. **\$1.98**
- B** Lightweight Spectacle type; full angle vision, non-inflammable plastic frame. Crystal clear 44-mm. flat lenses. Wire cored paddle temples. 28 A 6067—Shipping weight 5 oz. **\$1.79**
- C** Industrial Chipping, Grinding Goggle. Eye protection from all directions, 50-mm. hardened ground lenses, composition frame, adjustable headband. 28 A 6060—Shipping weight 9 oz. **\$2.35**
28 A 6061—Similar to above, but larger to fit over regular glasses. Shipping weight 12 oz. **\$2.49**
- D** Welders' Goggle. Shade 5 lenses; for light acetylene welding, cutting. Elastic headband, ventilated side shields. Screw caps for changing lens or cover glass. 28 A 6053—Shipping weight 4 oz. **\$2.39**
- E** Over-spectacle style... made for wearing over regular glasses. Similar to 28 A 6053. 28 A 6054—Shipping weight 12 oz. **\$2.75**
28 A 6055—Extra No. 4 density Filter Lenses, 50-mm.; for welding, etc. Shipping weight 3 oz. **Pair 85c**
28 A 6057—Extra No. 6 density Filter Lenses, 50-mm.; heavy welding. Shipping weight 3 oz. **Pair 85c**
- F** Wind, Dust Goggle... won't distort vision. Cloth sides filter dust, prevent fogging. Chenille bound edges; shatter-proof lenses for greater safety. 28 A 6068—Shipping weight 4 oz. **\$1.59**
28 A 6062—Same as above, but with plain glass lens. Shipping weight 4 oz. **.65c**
- G** Face Shield. Protects eyes, face; non-inflammable plastic. Metal-bound window snaps on shield. Sweatband; adjustable. 28 A 6085—Shipping weight 1 lb. **\$2.39**
28 A 6086—Extra Window. Wt. 8 oz. **.89c**
- H** Industrial Respirator... sure protection! Air-tight fit; valve can't stick open. Easy to clean and replace filter. Pliable non-irritating rubber. For all dust hazards... mineral, agricultural. Includes filter. 28 A 6073—Shipping weight 12 oz. **\$3.65**
28 A 6074—Extra Filter for above. Shipping weight 5 oz. **Each \$1.10**
28 A 6081—For fumes, vapors from paint spraying, dry cleaning, gasoline, etc. With filter. Design similar to 28 A 6073. Shipping weight 12 oz. **\$3.59**
28 A 6084—Extra Filter for above. Shipping weight 5 oz. **.75c**
- I** Low Cost Respirator. Protects against pollen; wood, grain, metal, stone dust. Lightweight molded rubber frame. 28 A 6087—Shipping weight 8 oz. **\$1.98**



WARNING: Respirators cannot be used as Gas Masks!

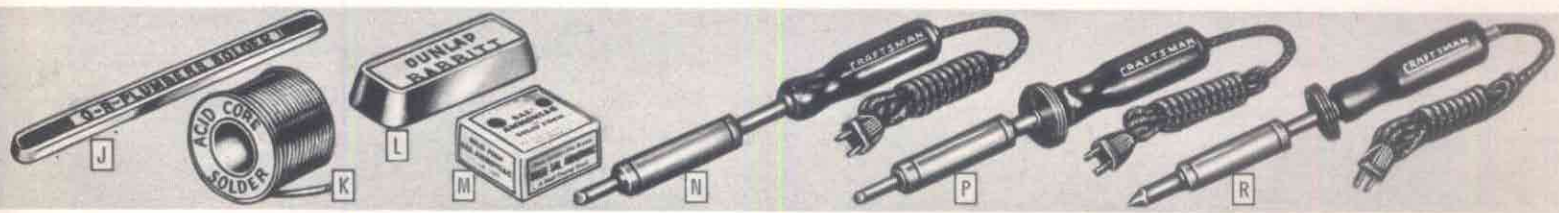

- J** Plumbers' Solder. Actual weight about 1 pound. 9 A 8085—Shipping weight 1 lb. 8 oz. **.75c**
- K** Core Solder. Flux in core, all set, ready to use. No soldering paste or soldering fluid needed. Acid Core Solder. For general soldering only. For electrical or radio work, use Rosin Core Solder. 9 A 8095—10-ft. coil. Shipping wt. 6 oz. **.35c**
9 A 8093—1-lb. spool. Shipping wt. 1 lb. 6 oz. **.93c**
- L** Rosin Core Solder. Non-corrosive and non-conductive. Best for electrical and radio work. 9 A 8102—10-ft. coil. Shipping wt. 6 oz. **.35c**
9 A 8100—1-lb. spool. Shipping wt. 1 lb. 6 oz. **.93c**
- M** Solid Wire Solder. (Not illustrated.) Requires flux. Diameter, ¼ in. 9 A 8090—1-lb. spool. Shpg. wt. 1 lb. 6 oz. **.85c**

- N** Babbitt Metal. Adopted as best for use in high speed heavy duty work. Pre-war quality. Quick forming... easy to use. Two sizes. 9 A 8081—State size bar wanted. About 2½-pound bar. Shipping weight 2 lbs. 10 oz. **\$1.19**
About 5-lb. bar. Shipping weight 5 lbs. 4 oz. **\$2.19**
- O** Sal Ammoniac. Solid type. For cleaning and tinning soldering coppers. Permits an even flow of solder. Shipping weight 6 oz. 9 A 8071... 4-oz. package **19c**

- P** CRAFTSMAN Electric Soldering Irons. You'd expect to pay much more for soldering irons of such good quality. Each one is approved by Underwriters' Laboratories, Inc. Heat quickly concentrated at point of copper tip by Nichrome element wound on Allegheny steel core. Smooth hardwood handles. For use on any 100-120 volt current. Each soldering iron comes complete with insulated cord, and plug.
- N** CRAFTSMAN, 100-watt. For radio or electrical work. 2½-ounce, ¾-in. replaceable copper tip, 4¼ in. long. 9 A 5381—Shipping weight 1 pound 8 ounces. **\$4.10**
- P** CRAFTSMAN, 150-watt. For general use. 2½-ounce, ¾-in. replaceable copper tip, 4¼ in. long. 3 cooling fins. 9 A 5382—Shipping weight 1 pound 8 ounces. **\$4.95**
- R** CRAFTSMAN, 200-watt. Heavy duty. Six-ounce replaceable copper tip, 4½ in. long; ½-in. diameter. 3 cooling fins. 9 A 5383—Shipping weight 1 pound 8 ounces. **\$5.45**

CRAFTSMAN Oxy-Acetylene Welders

Easy to operate . . . Handbook included

See the 8 super-quality features below

- (1) Tested and approved by Underwriters' Laboratories, Inc.
- (2) Approved by Associated Factory Mutual Insurance Company.
- (3) Tested and approved by Sears own testing laboratories.
- (4) Every part individually tested at factory before shipment.
- (5) All parts ground and hand fitted to eliminate leaks.
- (6) Regulators have patented safety pressure relief devices.
- (7) Exclusive balanced pressure non-flash mixer, beyond head of torch and outside of the torch handle, for maximum safety.
- (8) All parts are made of solid brass or bronze.

Farmers! Factories and industrial shops! Garages, repair and welding shops! Scrap yard operators! Maintenance men! Just what you've been looking for . . . a super-quality oxy-acetylene welding outfit at a price you can afford. Pays for itself many times over! Farmers—welding is easy! With this outfit and the Welders' Handbook (included) plus a little practice, you'll be able to do professional type welding for yourself and your neighbors. Readily portable . . . you can use it anywhere, even in areas where electrical power is not available or accessible. Make farm repairs in the field—no need to bring work into shop.

Heavy duty construction . . . extra safety too, because it's triple tested! Made by America's leading manufacturer of welding equipment. Has 17 1/4-in. bronze non-flash torch. 6-in. gooseneck is bronze drop forging—will not bend. Forged bronze-bodied regulators have 2 pressure gauges with brass cases, plate glass faces and etched silver dials; 0 to 80 and 0 to 3000 lbs. on oxygen regulator, and 0 to 80 and 0 to 500 lbs. on acetylene regulator.

Also included in this outfit! Five wide-range tips of one-piece solid drawn copper, highly polished (sizes AA-1, AA-2, AA-3, AA-4, and AA-5); two 12 1/2-ft. lengths of 3/4-inch high pressure hose (tested to 800 lbs. per square inch); assorted welding rods; flux; lighter; two wrenches; 50-mm. welders' goggles (meet Federal Specifications 4-GGG-G511A) and 258-page easy-to-understand Welders' Handbook. (This welding outfit may be used as a cutting torch with 9A5444 cutting attachment—not included; see below.)

99 A 05442—Complete outfit, as above. Shpg. wt. 25 lbs. . . . \$57.50
 9 A 5410—Flux only. Can be used for all kinds of acetylene welding. Shipping weight 1 lb. 3 oz. . . . 1-lb. can 60c
 9 A 5411—258-page Welders Handbook only. A very handy manual. Complete welding instructions. Shpg. wt. 1 lb. . . . \$3.50

\$57.50 CASH
\$6.00 DOWN . . .
 ON EASY TERMS

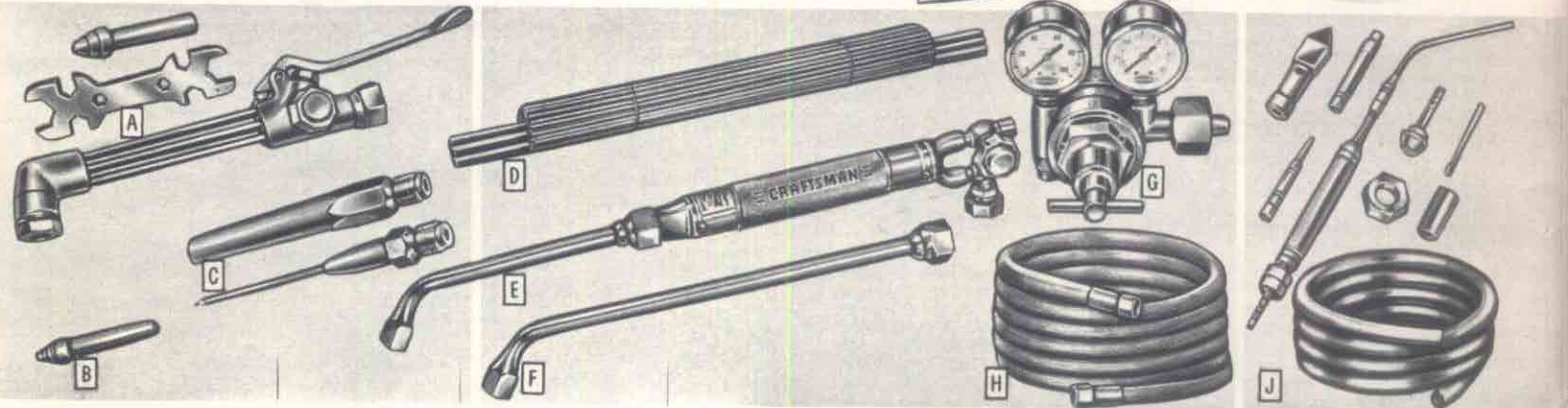

CRAFTSMAN Oxy-Acetylene Welding Attachments and Accessories

A CRAFTSMAN Cutting Attachment. Approved by Underwriters' Laboratories, Inc. Use with welders' outfit 99A05442 above. Replaces mixing attachment. Use in place of mixer. With one B-3 tip, wrench, instructions. 9 A 5444—Shpg. wt. 2 lbs. 12 oz. . . . \$14.50

B CRAFTSMAN Cutting Tips. For use with 9A5444 cutting attachment described and listed above. Shipping weight each 6 oz.
 9 A 5447—State size wanted . . . Each \$2.25

Size	Cuts Steel
B-1	Up to 3/8 inch
B-2	3/8 to 1/2 inch
B-3	1/2 to 1 1/4 inches
B-4	1 1/2 to 4 inches
B-5	4 to 6 inches

C CRAFTSMAN Welding Tips. Heavy, one-piece solid drawn copper. Polished finish. Use with 99A05442 listed above, or with 9A5429 listed at right. Shipping weight each 4 oz.
 9 A 5441—State size wanted . . . Each \$1.50

Size	Capacity, in.	Size	Capacity, in.
AA-0	Soldering . . .	AA-5	3/8 to 3/16
AA-1	3/64 to 1/16 . . .	AA-6	3/8 to 3/4
AA-2	3/64 to 3/8 . . .	AA-7	3/8 to 1
AA-3	3/8 to 3/16 . . .	AA-8	1 in. up
AA-4	3/16 to 3/8 . . .		

D Assorted Welding Rods. A complete selection of welding rods for oxy-acetylene welding of bronze, cast iron, aluminum, mild steel. Includes 90 rods as follows: four 3/8x18-inch and four 3/16x18-inch Tobin bronze rods; thirty 3/32x18-inch, twenty-two 3/16x18-inch, twelve 3/16x18-inch and eight 3/8x18-inch mild steel; four 3/16x18-inch drawn aluminum; seven 1/4x24-inch cast iron rods. 9 A 5440—Shpg. wt. 12 lbs. . . . \$4.60

E Model A Welding Torch. Approved by Underwriters' Laboratories, Inc. High quality bronze non-flashback torch with 6-inch gooseneck mixer, 17 1/4 inches long over all Gooseneck is solid bronze drop forging . . . will not bend. Will cut steel with 9A5444 cutting attachment listed at left. 9 A 5429—Shpg. wt. 3 lbs. . . . \$15.00

F 12-inch Mixing Chamber. Solid drop forged bronze construction. Gooseneck type. Necessary when using 9A5441 welding tips, sizes AA-6, AA-7 or AA-8 listed at left. 9 A 5443—Shpg. wt. 13 oz. . . . \$6.00

G Oxygen Regulator. Underwriters' Labs., Inc. approved. 0 to 80 and 0 to 3000-lb. gauges; brass cases. Guaranteed accurate. 99 AM 5430—Shipped express only. Shpg. wt. 5 lbs. 10 oz. . . . \$15.50

Acetylene Regulator. Approved by Underwriters' Laboratories, Inc. 0 to 80 and 0 to 500-pound gauges. Brass cases. Guaranteed accurate. 99 AM 5431—Shipped express only. Shpg. wt. 5 lbs. 6 oz. . . . \$14.00

High-pressure Oxygen Regulator. Approved by Underwriters' Laboratories, Inc. Use to cut metal thicker than 3 in. With 0 to 300 and 0 to 3,000-lb. gauges. Delivery pressure adjustable from 0 to 150 lbs. Shipped express from factory in Chicago; you pay shipping charges on delivery. 9 AM 5448F—Shipping weight 5 lbs. 10 oz. . . . \$15.50

9 A 5413—Adapter for Airco, Commercial or Searchlight tanks. Shipping weight 5 ounces. . . . \$1.25
 9 A 5414—Adapter for Prest-O-Lite auto lighting tanks. Shpg. wt. 5 oz. . . . 1.25

H 1/4-inch Green Oxygen Hose. With connections. State length wanted. 9 A 5437—12 1/2 feet. Shipping weight 1 lb. 13 oz. . . . \$1.65
 25 feet. Shipping weight 4 lbs. . . . 2.65

1/4-inch Red Acetylene Hose. With connections. State length wanted. 9 A 5438—12 1/2 feet. Shipping weight 1 lb. 13 oz. . . . \$1.65
 25 feet. Shipping weight 4 lbs. . . . 2.65

J CRAFTSMAN Heating-Brazing Set. Use with Prest-O-Lite cylinders to solder, braze, burn paint, etc. Operates on acetylene only. Requires pressure up to 4 lbs. for largest tip. Not to be used in connection with oxygen or air pressure. Includes: handle; three heating tips; soldering copper; paint burning tip; tank connection; tip cleaner; 5 ft. rubber hose. 9 A 5446—With instructions. Shipping weight 2 lbs. . . . \$6.50

"Easi-Bild" Patterns . . . Use only a hammer and a saw!

Just 3 simple steps . . . save money, time and effort . . .



(1) TRACE

Place pattern on wood and trace with pencil



(2) CUT OUT

Saw along traced lines with power or hand saw



(3) ASSEMBLE

Put together according to easy-to-follow directions

As low as **15¢** Here's the ideal way to save money and have fun doing it! You'll have a great time making your own work bench, boat, kitchen shelf, bookcase, toys, lawn chairs—even your own house, or any of the other things shown below and at right. Anyone who can drive a nail can build them. It's that simple! "Easi-Bild" Patterns take the mathematical mystery out of building things. No hard-to-read blueprints . . . it's the dress pattern idea applied to flat surface of lumber.

Just three simple steps as shown and described above . . . (1) Place "Easi-Bild" Pattern on wood and trace with pencil. (2) Saw along traced lines with either a power saw or a hand saw. (3) Assemble according to directions . . . and your article is ready for use, or for painting. Every "Easi-Bild" Pattern contains a full list of needed materials, recommended kind of lumber to be used, easy-to-follow, step-by-step directions, and assembly illustrations. Even shows you where to use screws, nails, bolts, etc.

The many things YOU can build with these patterns are shown on this page, set up. Look them over carefully now, and decide which patterns you want. Price and pattern number is listed below each pattern illustration. Lumber and materials not included. Postpaid. (Shipping weight each 6 ounces.)

9 A 2990—"Easi-Bild" Patterns. Please be sure to state pattern numbers wanted.

EVERY HOME NEEDS



No. 15 Handy Work Bench. .25c



No. 71 Tool Chest. .25c

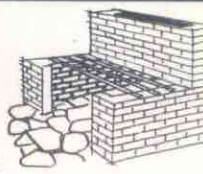

No. 73 Outdoor Fireplace. . . .25c



No. 1 Window Valance. .25c

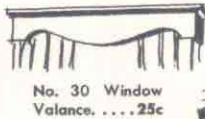

No. 30 Window Valance. . . .25c

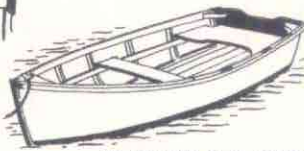

No. 85 Utility Boat. . \$1.00

KITCHEN EQUIPMENT

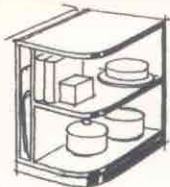

No. 3 Kitchen Unit. .50c

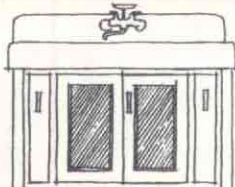

No. 41 Undersink Enclosure. .50c

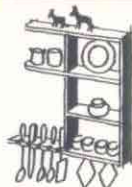

No. 5 Kitchen Shelf. .25c

BUILDINGS

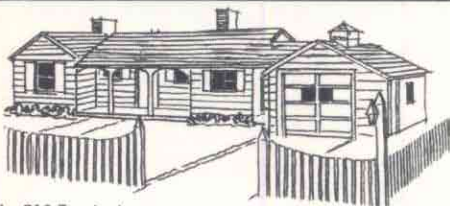

No. 910 Two-bedroom House. \$5.00



No. 91 Country Cottage. \$2.00

INTERIOR



No. 38 Corner Cabinet. .50c

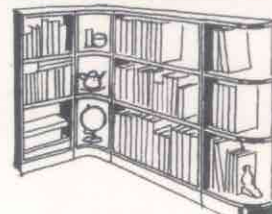

No. 42 Modern Bookcase. .50c



No. 18 Bookcase. .25c

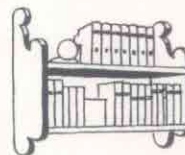

No. 21 Bookshelf. .15c

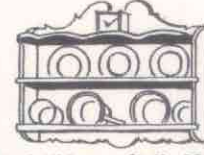

No. 6 All Purpose Shelf. .25c



No. 24 Wall Shelf. .25c

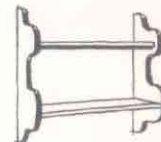

No. 35 Whatnot Shelf. .20c



No. 34 Whatnot Shelf. .20c



No. 25 Magazine Rack.25c

CHILDREN'S EQUIPMENT



No. 64 Colonial Cradle.25c



No. 34 Clothestree. 25c



No. 66 Wheelbarrow.25c



No. 53 Pony Ride Rocker.35c



No. 81 Lawn Ornaments. .25c



No. 54 Hobby Horse.20c



No. 65 Toy Chest. .25c



No. 33 Doll House. .50c

LAWN AND PORCH FURNITURE



No. 56 Foldaway Chair.25c



No. 32 Lawn Chair. .25c



No. 55 Foldaway Settee.35c



No. 22 Picnic Table. .25c



No. 39 Lawn Settee. .35c



No. 78 Garden Chaise. .35c



Handy Tool Light

Improper lighting in the shop costs money! You'll save money and have proper light if you use this handy work light. Easy-to-adjust, 18-inch flexible cable gooseneck permits movement to any desired position. New type triangular shades, which gives greater concentration of light, may be rotated 360 degrees.

Interlocking socket cannot be pulled apart. Has C clamp for fastening to work bench or tool. All steel construction; gray enameled finish. Takes 60-watt or smaller bulb. For 110-120-volt A.C. Complete with 6-ft. plastic cord and plug.

9 A 2536—Shpg. wt. 2 lbs. **\$2.95**

\$2.95

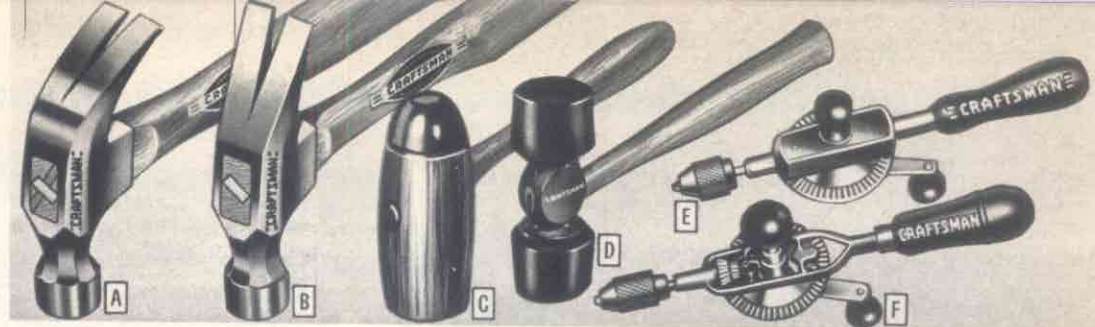

CRAFTSMAN Hammers and Mallets

CRAFTSMAN Hammers. Polished heads, drop forged from "Super-Tuff" steel. Faces beveled to resist chipping. White hickory handles, double steel wedged in tapered eye. Flared rubber tips on handles. **\$2.25**

A 9 A 3814—Curved Claw Carpenters' Hammer. State size wanted. Size 2. 13-ounce head. Shipping weight 1 pound 12 ounces. **\$2.25**
Size 1½. 16-ounce head. Shipping weight 2 pounds 2 ounces. 2.25

B 9 A 3816—Straight Claw (Rip) Hammer. Same quality as above. Size 1½. 16-ounce head. Shipping weight 2 lbs. 2 oz. **\$2.25**

C 9 A 3809—Straight Claw Tradesman's Hammer. Same quality as above. Size 1. 20-ounce head. Shipping weight 2 lbs. 6 oz. **\$2.35**

DUNLAP Wood Mallet. Seasoned hickory head; size 4; 2½x5½ in. **49c**
DUNLAP Rubber Mallets. Rubber composition head, 10-in. hardwood handle molded securely to head. **59c**

CRAFTSMAN Hand Drills

E Streamlined die-cast frame. Double pinion gear. Machine cut pinion and gear. 3-jaw chuck for round shank drill up to ¼ inches. Hardwood handle, mahogany finished. Overall length 12 inches. **\$2.49**

9 A 4243—Shpg. wt. 2 lbs. 10 oz. **\$2.49**

F Matched machine cut gears. 3-jaw chuck for round shank drills up to ¼ in. Screw-cap hollow hardwood handle for storing drills. Overall length 12½ inches. **\$2.95**

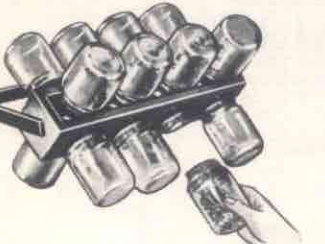

Workshop Dispenser

Convenient. Ideal for screws, nails, small parts, etc. Transparent glass containers let you see the part you want. . . find the item you need instantly. Turn the frame; unscrew the jar. Frame is of sturdy steel, enameled bright red. Sixteen 4-oz. screw-on glass jars. Turns on black enameled steel bracket that fastens to wall or ceiling. Over-all length 12½ in.; depth 9¾ in. with bracket. Mounting screws included.

9 A 7200—Shpg. wt. 7 lbs. 8 oz. **\$2.19**

\$2.19

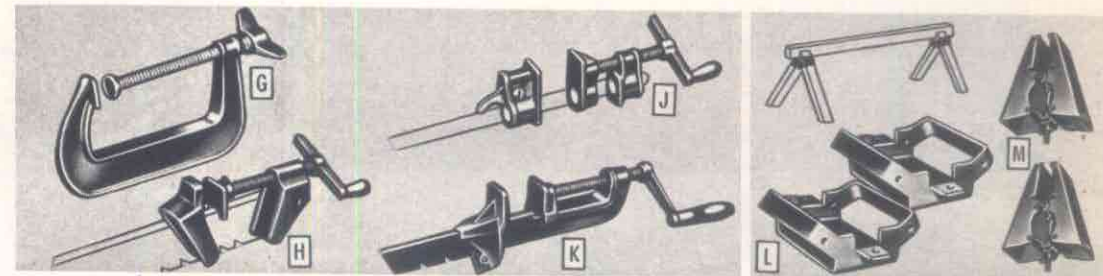

Heavy Duty Clamps

G Iron C Clamps. Strong clamps with Acme-threaded screw. Self-adjusting swivel head.

9 A 6667—Please state size.

Opens to	Shpg. wt.	Each
3 inches	1 lb. 8 oz.	\$.075
4 inches	2 lbs. 2 oz.	1.00
5 inches	2 lbs. 8 oz.	1.10
6 inches	3 lbs. 2 oz.	1.30
8 inches	4 lbs. 8 oz.	1.80

H Gluing Clamp. Wood bar type. For any length wood bar. 1½x2½ inches. Malleable iron. Sliding jaw has 1½x1½-in. face. Has convenient crank adjustment. Shpg. wt. 4 lbs. 8 oz.

9 A 6673. **\$2.10**

J Gluing Clamp. Adjustable pipe style. Use with any ¾-inch threaded pipe. Made of malleable iron. Has convenient crank adjustment. Sliding jaw has 1½x1½-inch face; handy lever lock. With cap for end of pipe. Pipe not included.

9 A 6674—Shpg. wt. 3 lbs. 14 oz. **\$2.45**

K Cabinet Makers' Steel Clamp. T-bar type. Bar is 1½x½x¾ in. Sliding jaw has 1½x1½-inch face; locks in notches.

99 A 06676—Please state size.

Opens to	Shpg. wt.	Each
3 feet	8 pounds	\$4.50
4 feet	9 pounds	4.98

Sawhorse Brackets

Two types for making your own sawhorses quickly and easily—set up tables, platforms, etc. Lumber is not included with brackets.

L For use with 2x4's. Made of heavy gauge, rust-resistant plated steel. Electrically welded into one solid unit for strength and rigidity. Wedge shaped.

9 A 2889—Shpg. wt. 3 lbs. Pair, **\$1.30**

M New type. Needs no nails, screws or bolts. Rust-resistant plated steel.

9 A 2848—For 1x4's. Shipping weight 6 pounds. Pair **\$2.75**

9 A 2849—For 2x4's. Shipping weight 7 pounds. Pair **\$3.10**

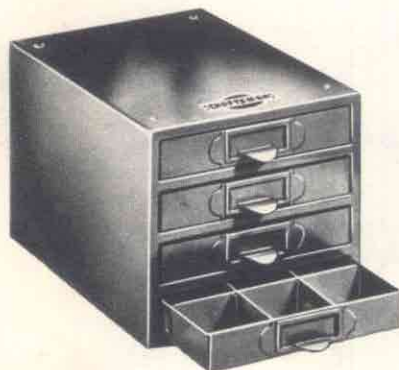

Tool Cabinet

Handy four-drawer tool cabinet. Ideal for storing small tools and parts. Drawer fronts have useful index card holders and pulls. Made of 24-gauge sheet steel, electrically welded. Dimensions: length 10 in.; width 7½ in.; height 8¾ in. Each of four drawers, 7½x10x1½ in., have 12 partitions that are adjustable and removable. Smooth machinery gray finish.

9 A 6531—Shpg. wt. 8 lbs. **\$4.50**

\$4.50

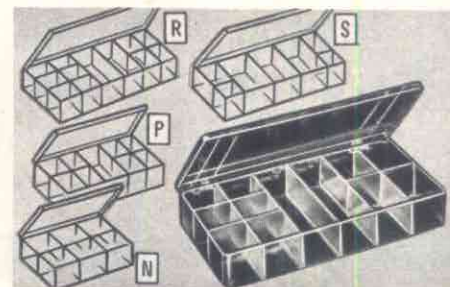

Transparent Plastic Utility Boxes

Don't mislay those small machine, radio or electrical parts! Store them safely in one of these transparent plastic boxes. The ideal container for holding hobby shop items, fishing tackle—flies, lures, hooks, etc.; tacks, screws, nails, washers, etc. Also handy for women's earrings, jewelry, buttons, etc. Exceptionally lightweight. Thick transparent plastic walls keep items separated, yet easy to find without opening box. Dirt and dust-free! Snug covers with smooth working hinges. In various sizes with various size compartments. See small views above for types available. Get several today.

Catalog No.	Compartment	Length	Width	Depth	Shpg. wt.	Each
(N) 9A6525	Six	4½ in.	2¾ in.	1 in.	8 oz.	35c
(P) 9A6523	Nine	7 in.	3½ in.	1¼ in.	9 oz.	59c
(R) 9A6530	Twelve	8¼ in.	4¼ in.	1¼ in.	11 oz.	85c
(S) 9A6526	Seven	8¼ in.	4¼ in.	1¼ in.	11 oz.	85c
9A6528	Eighteen	11 in.	6½ in.	1¼ in.	1 lb. 2 oz.	\$1.89

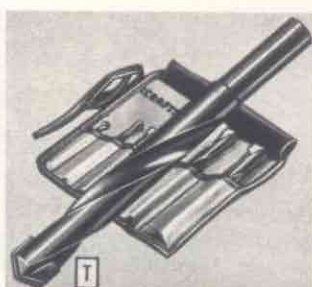

CRAFTSMAN Masonry Drills

T Of steel with carbide tips. Accurate. New type; spiral flutes for faster, cleaner cutting. Drills stone, marble, concrete, etc. Round shank for use with electric or hand and breast drills.

9 A 6731—Set of 6 CRAFTSMAN carbide-tipped Masonry Drills. One of each size listed below. In fabric carrying or storage case. Shipping weight 2 lbs. **\$11.95**

9 A 6730—State size wanted.

Size	Shank	Length	Shpg. wt.	Each
¼-in.	¼-in.	4 in.	4 oz.	\$1.35
⅜-in.	⅜-in.	4 in.	4 oz.	1.55
½-in.	½-in.	4 in.	6 oz.	1.69
⅝-in.	⅝-in.	6 in.	8 oz.	1.95
¾-in.	¾-in.	6 in.	10 oz.	2.45
¾-in.	¾-in.	6 in.	12 oz.	3.19

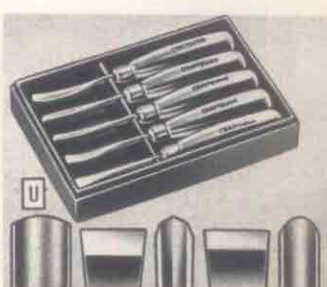

Wood-carving Set

U CRAFTSMAN 5-pc. Set. For carving models of all kinds, cutting linoleum, printing blocks, etc., by craftsmen, hobbyists and artists. Complete 5-pc. set has ⅝-in. bent gouge, ⅝-in. bent chisel, ⅝-in. "U" tool, ⅝-in. straight chisel, and ⅝-in. veining tool. 2½-in. long, forged, heat treated steel blades hold a keen edge; withstand repeated sharpening. Comfortable 3½-in. hardwood handles; metal ferrules. In box. Shpg. wt. 13 oz.

9 A 2899—5-pc. set. **\$3.25**

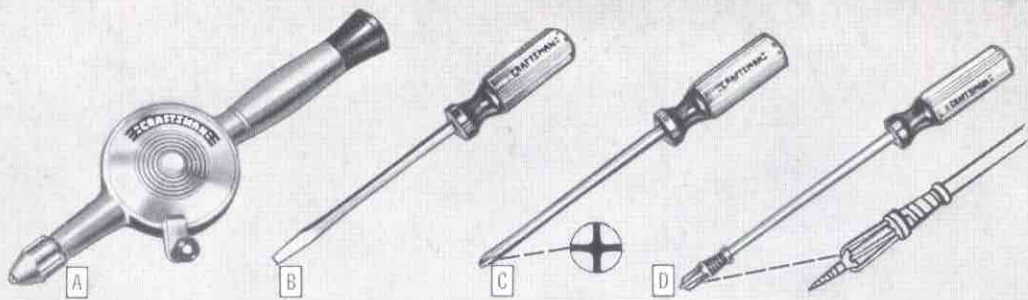

Streamlined Hand Drill

A CRAFTSMAN. Rustproof, die-cast aluminum frame; 12 $\frac{3}{4}$ -in. long, overall. Fully enclosed driving gear cast as integral part of turning section. New type Jacobs chuck. Jaws held together with DuPont Neoprene; no springs to weaken. Drills wood or metal. Takes round shank drills up to $\frac{3}{4}$ -in. diameter. Hollow handle stores drills.
9 A 4242—Shpg. wt. 1 lb. 12 oz. **\$.295**
9 A 4230—Set of 8 Drills. Fit all hand drills. For drilling wood. Sizes $\frac{1}{16}$ to $\frac{1}{4}$ in. Shpg. wt. 4 oz. **.45c**

CRAFTSMAN high quality Screwdrivers

B Heavy duty Screwdrivers. Blades of "Super-Tuff" steel. Amber color plastic handles. Square stock blades.
9 A 4148—State size.

Blade, in.	Shpg. wt.	Each
4x $\frac{3}{4}$	5 oz.	59c
4 $\frac{1}{2}$ x $\frac{3}{4}$	4 oz.	55c
6x $\frac{3}{4}$	6 oz.	75c
8x $\frac{3}{4}$	12 oz.	95c
9x $\frac{3}{4}$	10 oz.	69c
12x $\frac{3}{4}$	10 oz.	95c
12x $\frac{3}{8}$	16 oz.	\$1.19

C Phillips-type Screwdrivers. Amber color or plastic handles; "Super-Tuff" steel blades. Gauged points accurately fit recessed heads of Phillips screws; lessen danger of marring work.
9 A 4129—State size.

Size	blade	Shpg. wt.	Each
1	3-in.	4 oz.	59c
2	4-in.	5 oz.	75c
3	6-in.	6 oz.	95c

D Screwholding Screwdrivers. Spring steel clips hold screw to "Super-Tuff" steel blade; for easier use in hard-to-reach spots. Shockproof, amber-color or plastic handles.
9 A 4112—State size.

blade, in.	Shpg. wt.	Each
2 $\frac{1}{2}$ x $\frac{3}{8}$	4 oz.	45c
4x $\frac{3}{8}$	5 oz.	49c
5x $\frac{3}{8}$	6 oz.	69c
7x $\frac{3}{8}$	8 oz.	75c



Automatic Screwdriver

CRAFTSMAN. Heavy duty. Machined, "Super-Tuff" steel spirals. Drive or draw screws by pushing on handle. Left or right hand ratchet can be set rigid; locks closed. With 3 bits: small, medium, large.
9 A 4140—Pistol-grip handle. Standard size. Tenite plastic handle. Gives more leverage than straight type. Bits store in handle. Length extended, with bit, 19 $\frac{1}{2}$ in. Shpg. wt. 1 lb. 8 oz. **\$.4.25**
9 A 4143—Chuck and 8 Drills. (Not shown.) Converts 9A4140 and 9A4138 screwdrivers, above and below, into drills. Not for use with 9A4134. 8 drills, $\frac{1}{16}$ to $\frac{1}{4}$ in. Shpg. wt. 3 oz. **\$.1.09**

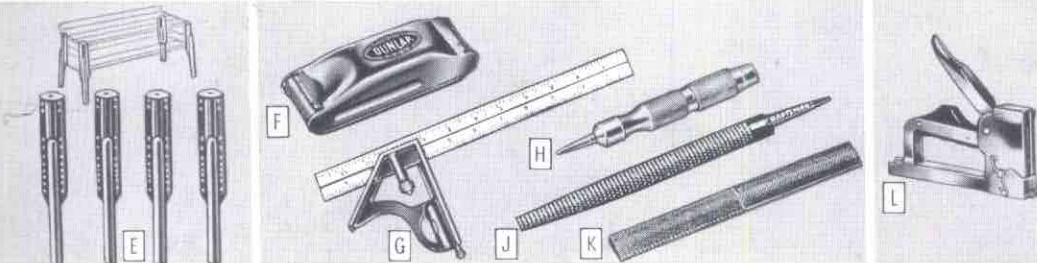

Bench Leg Sets

E Four steel bench legs of heavy cold rolled steel. Holes for installing lower shelf or cross braces at six different heights as desired. Enameled gray. With 4 legs, shelf-supporting brackets, lag screws, cadmium plated bolts, lock washers, nuts and instructions. Wood parts not included.
99 A 02732—26-in. high. Shpg. wt. 17 lbs. **\$.5.50**
99 A 02731—31-in. high. Shpg. wt. 18 lbs. **\$.5.50**

DUNLAP Sanding Block

F 6-inch bright steel block frame with 30x1 $\frac{3}{8}$ -inch roll of medium grit paper, stretched over felt cushion.
9 A 3681—Shpg. wt. 12 oz. **.75c**
Sanding Refill for above sanding block. 30x1 $\frac{3}{8}$ -inch rolls, medium grit. Shipping wt. 3 oz.
9 A 3688.....3 rolls for **27c**
G CRAFTSMAN Combination Square. Steel blade graduated in 8ths and 16ths in. Blade slotted so semi-steel handle, level and scribe handle can be moved to any point. Shpg. wt. 1 lb. State size.
9 A 3954—9-in. blade **\$.1.25**
 12-in. blade **\$.1.29**

Self-centering Punch

H CRAFTSMAN. Steel body; knurled for sure grip. Nickel plated. 3 inches long, over-all. Shipping weight 4 ounces.
9 A 4262..... Each **25c**
I CRAFTSMAN Half-round Rasps
J Shoe Rasps. Half-round, general purpose rasps. Half of each surface rasp cut; other half file cut. Sides smooth. State size.
9 A 6777—8-in. Shpg. wt. 3 oz. **55c**
 10-in. Shpg. wt. 6 oz. **69c**
K Half-round Rasps. Tapered sides.
9 A 6776—State length.

Length	Shpg. wt.	Each
8-inch	10 oz.	.75c
10-inch	14 oz.	.95c
12-inch	1 lb. 4 oz.	\$1.35

Screen Stapler

L Automatic type. Handy...fast! Leaves one hand free. Drives heavy (.050) staples in $\frac{1}{2}$, $\frac{5}{16}$ and $\frac{3}{8}$ -in. lengths. With screen stretching attachment. Steel, nickel plated. 7 $\frac{3}{8}$ in. long.
9 A 6864—Shpg. wt. 2 lbs. 4 oz. **\$.7.45**
9 A 6865—Heavy (.050) staples. 5000 in pkg. Shpg. wt. 2 lbs. Be sure to state length wanted.
 $\frac{1}{2}$ -in. long. Pkg. **\$.1.89**
 $\frac{5}{16}$ -in. long. Pkg. **\$.2.25**
 $\frac{3}{8}$ -in. long. Pkg. **\$.2.25**



Automatic Screwdrivers

CRAFTSMAN. Professional quality; heavy duty. Straight hardwood handle. Polished steel frames. Precision-machined "Super-Tuff" steel spirals give powerful action. Drive or draw screws simply by pushing on handle. Left or right hand ratchet can be set rigid; locks closed. Complete with 3 bits in small, medium, and large size.
9 A 4138—Standard size. Length extended, with bit 18 $\frac{3}{8}$ inches. Shipping weight 1 lb. 8 oz. **\$.3.75**
9 A 4134—Large size. Length extended, with bit, 25 inches. Shipping weight 1 pound 12 ounces **\$.5.15**

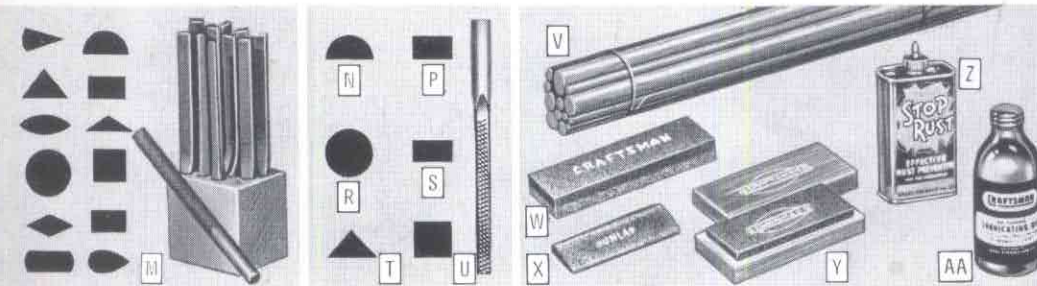

CRAFTSMAN Jig Saw File Set

M Fit all standard jig saws. Help eliminate tedious hand filing on metal or wood patterns, dies, scroll work, etc. $\frac{3}{4}$ -in. round shanks; 3 $\frac{1}{4}$ in. long. Swiss patterns, size 00, sharp, deep-cut teeth. Files in 12-pc. set are: 3 pillar, 1 each three-square, square, round, crochot, quarter-round, triangular, diamond, knife, and round back. In wooden box.
9 A 6778—Shpg. wt. 12 oz. **\$.7.50**
Special Jig Saw Files. Made from special steel; heat treated, tempered, hardened. Strong, deep-cut teeth stay sharp, wear long. $\frac{3}{4}$ -in. square shanks. Shpg. wt. each 1 oz.

N 9 A 2742—Half Round File	Each 65c
P 9 A 2740—Pillar File	Each 65c
R 9 A 2738—Round File	Each 65c
S 9 A 2739—Crochet File	Each 65c
T 9 A 2737—3-Square File	Each 65c
U 9 A 2741—Square File	Each 65c

Wood Dowels

V For model building, furniture repairs, etc. Clear grain hardwood. Pkg. of 14; $\frac{1}{4}$ to $\frac{3}{4}$ -in. diameter; 16 in. long.
9 A 2909—Shpg. wt. 14 oz. **\$.35c**
W CRAFTSMAN Sharpening Stones. Keep tools sharp. Vitrified silicon carbide. One side fine grit; other side coarse.
9 A 6440—State size wanted.
 5x2x $\frac{3}{4}$ in. Shpg. wt. 12 oz. **95c**
 6x2x1 in. Shpg. wt. 1 lb. **\$.1.19**
 7x2x1 in. Shpg. wt. 1 lb. 8 oz. **1.49**
X DUNLAP Medium Fine Slip Stone. Round edge, medium fine. For gouges and round-shaped tools.
 4x1 $\frac{3}{4}$ in.; taper $\frac{1}{2}$ to $\frac{3}{16}$ in.
9 A 6454—Shpg. wt. 12 oz. **59c**

Combination Stone

Y CRAFTSMAN. Vitrified silicon carbide. One side fine grit; other coarse. Wood case opens on either side; protects stone; makes stone easier to hold when sharpening. 5x2x $\frac{3}{4}$ in. Our finest stone.
9 A 6437—Shpg. wt. 1 lb. **\$.1.39**
Z DUNLAP Stop-Rust. Protects tools. Brush, spray or dip on. Safe to handle; non-inflammable.
9 A 2927—State no. cans wanted.
 8 oz. can. Shpg. wt. 9 oz. **39c**
 Four 8-oz. cans. Shipping weight 2 lbs. 4 oz. **\$.1.39**
AA CRAFTSMAN Lubricating Oil. For shop use, etc. Won't gum.
9 A 6547—State size.
 $\frac{1}{2}$ pt. Shpg. wt. 8 oz. **19c**
 1-pint. Shpg. wt. 1 lb. **35c**

CRAFTSMAN Push Drill

Automatic type. New! Finest drill of this kind we've ever seen! Compare it with any drill of its type for features, quality and low price! Streamlined design; properly balanced. Just the drill for boring holes in record time. Internal precision machined bronze spirals give smooth automatic action. 4-jaw chuck of hardened steel holds drill points firmly. Heavy chrome plated finish; rust-resistant. Blue enameled handle; grooved to prevent slipping. Complete with eight drill points, sizes $\frac{1}{16}$ to $\frac{1}{4}$ inch; which store safe and handy in magazine-type handle. Length 9 inches.
9 A 4216—Shipping wt. 1 lb. **\$.2.75**

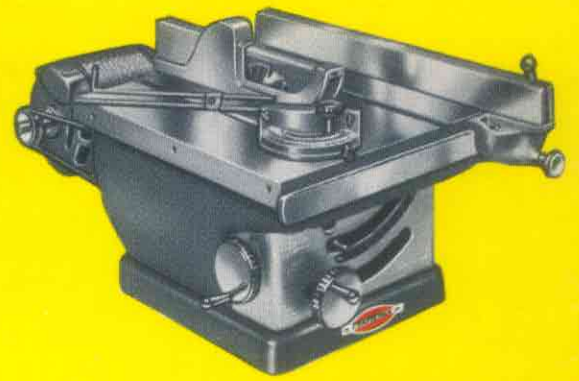

CRAFTSMAN POWER TOOLS

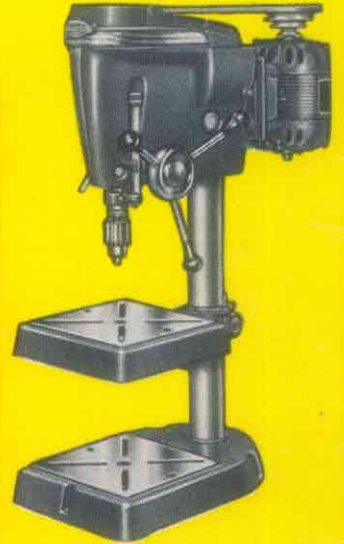

More Americans Buy
CRAFTSMAN Power Tools
than any other brand..

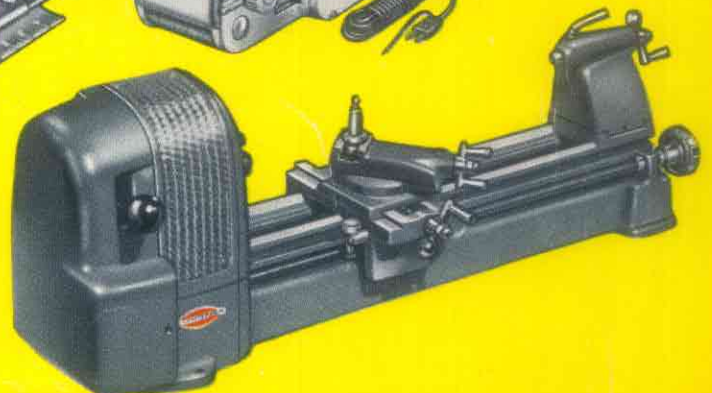
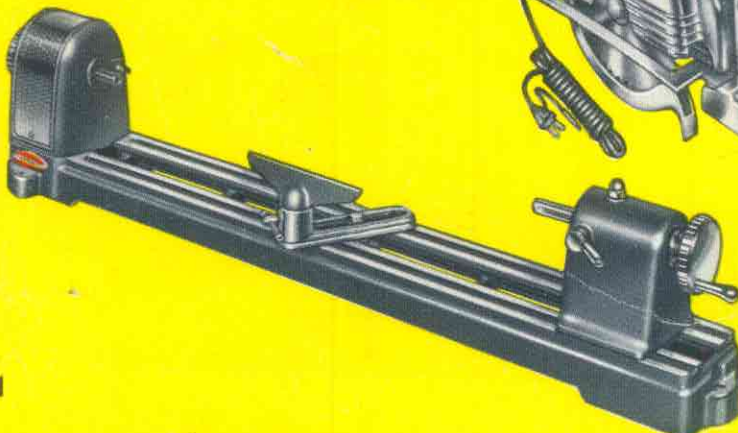
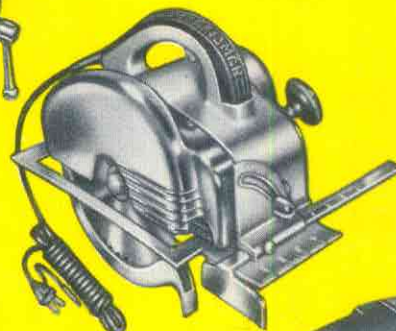

SEARS, ROEBUCK AND CO.