

**CRAFTSMAN** and **COMPANION**

# POWER TOOLS

*by Sears*



**LATEST 1936 MODELS**

**Finest in Design . . Unequaled  
in Engineering Development**

**SEARS, ROEBUCK AND CO.**

**World's Largest Distributors of Power Tools**

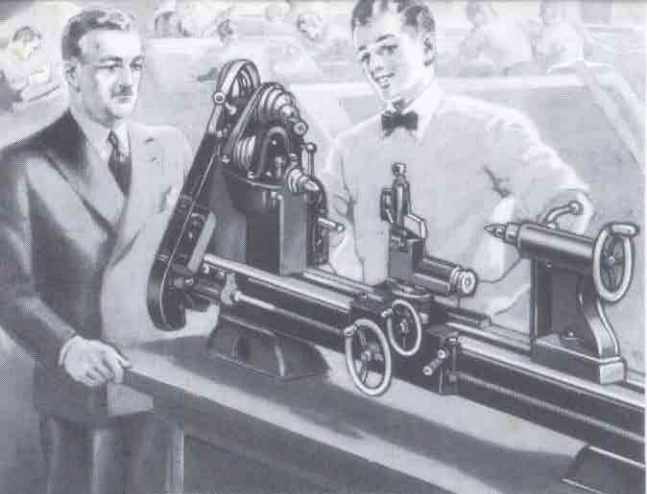

# LEADERSHIP!

Sound Engineering . . . Highest Quality Materials . . . Money Saving Prices . . . Have Made **CRAFTSMAN** Power Tools the Nation's Choice

## GUARANTEE

WE GUARANTEE EVERY CRAFTSMAN OR COMPANION POWER TOOL AS WELL AS EVERY MACHINE, MOTOR OR ACCESSORY SHOWN IN THIS CATALOG TO BE EXACTLY AS DESCRIBED AND ILLUSTRATED, TO GIVE YOU PERFECT SATISFACTION AND TO REPRESENT FULL VALUE FOR THE PRICE PAID. IF YOU ARE NOT FULLY AND COMPLETELY SATISFIED WITH YOUR PURCHASE, RETURN IT TO US AND WE WILL REFUND YOUR MONEY TOGETHER WITH ANY TRANSPORTATION CHARGES YOU MAY HAVE PAID.

NOT BY mere chance did Sears become the nation's headquarters for Quality Power Tools. Years of development work . . . the combined thinking of our own expert engineers and those of America's foremost power tool manufacturers . . . the selection of first quality materials, parts and accessories . . . combined with Sears vast buying power . . . enable us to stand four-square against the field as *the largest distributor of fine power tools in all the world*. . . But mere size and volume of business alone were in no wise responsible for Sears present position of leadership! It required a fearless courage to build to higher standards than the industry believed possible or necessary . . . a grim determination to break away from the old and the obsolete . . . a broad vision to see that in the design and manufacture of power tools engineering brains of the highest order were just as essential as in the production of automobiles, airplanes and streamlined trains!

When you order ANY Power Tool from Sears you get soundly engineered machinery, built of the finest materials obtainable and sold at a price that ALWAYS saves you money.

## INDEX

Aprons	34
Band Saws and accessories	10, 11
Belts	32
Bench Saws and accessories	2-6, 35, 37
Bench Work	34
Blue Prints	34
Carving Tools	36
Drill Presses and accessories	13-17
Electric Drills and accessories	33
Flexible Shaft and accessories	18-19
Glue Pots	36
Grinder and accessories	28, 29, 36
Instruction Books	34
Jig Saws and accessories	7-9, 37
Jointers and accessories	20-21
Line Shafting and accessories	32
Machine Stands	35
Metal Lathes and accessories	26-27
Motors and accessories	30-32
Motor Rails	32
Paint Sprayers	36
Pulleys	32
Sanders and accessories	20
Shapers and accessories	12
Spot Welders	36
Sprayers, Paint	36
Tool Clips	34
Trestle Joints	34
Welder, Spot	36
Wood Lathes and accessories	22-25, 35, 37
Work Benches	34
Workshop, complete	37

### Important Information Regarding Prices

Should the Federal Government or any State find it necessary to increase by taxes or otherwise the cost or selling price of any of the merchandise described in this Catalog, we reserve the right to add any such taxes or other increases of cost or selling price to the prices of merchandise shown in this Catalog.

## EASY PAYMENT TERMS

On Orders Amounting to \$20.00 or More.

Purchase What You Need Now!

A great number of our customers who do not have all of the ready cash set aside for their Power Tool purchases have found Sears Easy Payment Plan most convenient. We invite you to make use of this Plan when buying any power tools shown in this catalog, provided the total price amounts to \$20.00 or more. Simply select the tools you want, add up the cash prices of the various items selected and figure the terms according to the table below.

When using this Plan you merely make the down payment when you order, paying the balance, including carrying charge, in easy monthly installments. Why not make use of Sears Easy Payment Terms when sending your order?

### HERE ARE YOUR EASY TERMS

If Cash Price of Order is	Add for Easy Payment Terms	Down Payment	Monthly Payments
\$20.00-\$25.00	\$2.50	\$3.00	\$4.00
25.01- 30.00	3.00	3.00	5.00
30.01- 35.00	3.50	4.00	5.00
35.01- 40.00	4.00	4.00	5.00
40.01- 45.00	4.50	5.00	5.00
45.01- 50.00	5.00	5.00	5.00
50.01- 60.00	5.50	5.00	6.00
60.01- 70.00	6.50	6.00	7.00
70.01- 80.00	7.50	7.00	7.00
80.01- 90.00	8.50	8.00	8.00
90.01-100.00	9.50	9.00	8.00
100.01-125.00	11.00	10.00	9.00
125.01-150.00	13.00	12.50	10.00

### Handy Table of Pulley Speeds

Use this table to determine the speed of driven machines with varying sizes of motor and machine pulleys. Figures given are for use with belt at proper tension and a motor speed of 1725 R.P.M.

Diameter of Motor or Driving Pulley	Diameter in Inches of Driven Pulley or Pulley on Machines						
	1½	2	2½	3	4	5	6½
1½ in.	1725	1290	1030	860	645	520	400
2 in.	2300	1725	1380	1150	860	690	530
2½ in.	2890	2160	1725	1440	1080	860	660
3 in.	3450	2590	2070	1725	1290	1030	800
4 in.	4600	3450	2760	2300	1725	1380	1070
5 in.	5750	4310	3450	2870	2160	1725	1330
6½ in.	7460	5600	4490	3740	2800	2240	1725

**Example**—the machine has a 2-inch pulley and should run 3450 or 3500 R.P.M. What size pulley should be used with a 1750 R.P.M. motor? From the table follow down the vertical 2-inch column to the speed 3450, then to the left in column headed "Diameter of Motor or Driving Pulley" read 4-inch diameter required.

Use one of Our Easy Payment Order Blanks. Write our Personal Service Department for terms on purchases over \$150.00.



Tools which represent a real advance in design are the product of much thought, inquiry, research and experience. Sears has developed this process to a high degree—brought it to a focal point in a central office where all efforts are coordinated and results achieved in the most efficient manner. This organization has a breadth and scope that is unmatched.



# The Greatest Advancement in the HISTORY OF POWER TOOLS

THE Power Tools you will find illustrated and described in this book represent a long step forward. Sears have a dominant position in this field. Our engineers, through our several hundred retail stores and our ten huge mail order houses, are in direct touch with the needs and the problems of Power Tool users everywhere. Each day the Power Tool salesmen in our retail stores talk with countless thousands of Power Tool owners. Each week our buyers receive and analyze hundreds of letters coming to our Central office from every state in the union. Thus we not only know the tools our customers want, but we are in a position to work with them in designing new and improved tools that more exactly meet their needs. No other distributor has so remarkable an opportunity to do this as Sears. And no other distributor, to our knowledge, uses this opportunity so wisely for their customers' benefit!

The illustrations on this page depict the building of a tool—beginning at the upper left hand corner of the page, Power Tool experts in consultation on a newly designed tool considering all the virtues and weaknesses of all existing tools of this type, the comments of customers—craftsmen, factory users etc.—materials, everything required to produce better tools. Above at the right, in the larger illustration, our manufacturers' engineers working with our own experts to produce a perfect model of the proposed tool. Every detail of construction is studied from every possible angle before the tool receives our OK. When approved, it is put into production using only the best materials produced by the best methods. At every step during manufacture it is inspected and tested to insure perfection of materials and workmanship. Before shipment it receives a final testing and inspection.

Small wonder that Sears Power Tools are so expertly designed, so sturdily built and so accurately assembled!

This method of designing and building our Power Tools is responsible for the many engineering advancements and constructional betterments found in the tools shown in this catalog.

The alertness of our staff, our great testing facilities, our tremendous buying power and our will to produce better tools brings to you not only the latest mechanical improvements but also the finest materials uncovered by recent metallurgical developments—all tried—all tested—all better, every step an advance. This continual striving for perfection has developed for us new standards of precision through the use of finer, more accurate machining or the utilization of newer and better materials. It has brought about the introduction of new standards of safety for your protection. And it enables us to include in this catalog many new tools of unusual interest to the craftsman who wishes to still further broaden the usefulness of his shop.

Sears Power Tools reflect the combined ideas of America's millions of professional and amateur craftsmen, shop owners, factory production men and all other types of power tool users, allied with the nation's most progressive group of engineering and manufacturing experts, working together to bring you the most advanced line of **QUALITY** Power Tools ever offered by any distributor in the world—at prices that always offer you great savings!

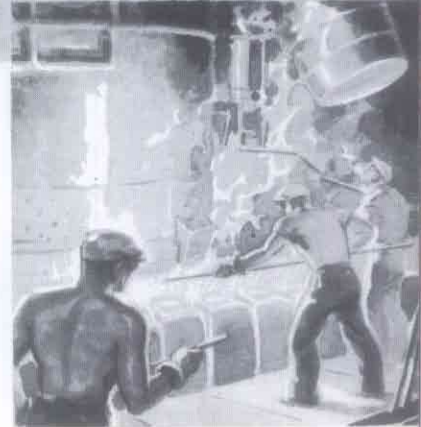

Sears — largest distributor of power tools in the world—takes advantage of latest metallurgical developments to insure the use of the finest material for each part.



Volume production effects great economies and permits the use of special tools and closer, more accurate inspection. Your assurance of quality.

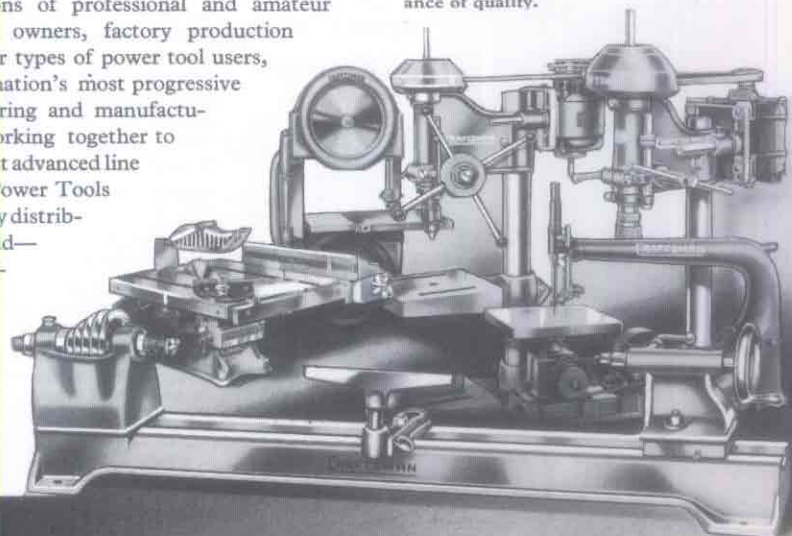

# Sears

**\$10<sup>95</sup>**



# COMPANION

## 7-INCH BENCH SAW

- Depth of cut easily adjusted by ball crank and gear mechanism.
- Operating mechanism completely enclosed.
- New type auto-lubricating bronze bearings.
- Equipped with 7-inch diameter saw blade.
- Table tilts to any angle from 0° to 45° with adjustable stops for both positions.
- Fitted with removable insert for dadoing.
- Ripping fence is rugged and accurate.
- Equipped with miter gauge and approved safety guard, latest design.
- Full 2 1/4-inch depth of cut.

Every home craftsman would like to own a really good bench saw—one with ample capacity for most any job, and one which represents the finest quality possible to build into a medium sized saw. We confidently believe the COMPANION 7-Inch Bench Saw provides the answer to this demand. It certainly has all of the features found in bench saws selling for much higher prices. And you can take our word for it that the quality is there!

## An Entirely New Design, Unmatched in Value . . . Without Equal Under \$20.00

### Dust Collecting Outfit

Consists of dust guard (A) and sawdust chute (B) for attaching to base of your 7-inch bench saw. Dust bag collects sawdust, making this saw one of the very cleanest ever built. Shpg. wt., 5 lbs. 8 oz.

9 P 2246...\$1.10

### Extension Table

Will more than double the table capacity of this saw. Fitted with slot for miter gauge and machined to accommodate ripping fence. Very easy to attach; exceptionally sturdy and well built. Shpg. wt., 6 lbs.

9 P 2245...\$2.95

### COMPANION Machine Stand

For bench saw 99 P 2228. Size of top, 10x21 in. Height, 31 in. Shipped knocked down with all necessary bolts and fittings for easy assembly. Shpg. wt., 33 lbs.

99 P 2719...\$4.25

### COMPANION Tool Light

Easy to attach; throws light on the work—extra large reflector keeps light out of your eyes. Has 15-in. flexible neck. Over all length, 23 in. Fitted with clamp; also drilled for bolting to machine. Shpg. wt., 1 lb. 12 oz.

9 P 2264...\$1.45

You can easily pay twice Sears low price for a 7-inch bench saw and still not get as finely designed and carefully built a piece of mechanism as our COMPANION! For we have built more real quality into this sturdy little saw than even we imagined could be done for this price. As a result you can do a wide variety of work with it, and, by adding an extension table at small cost, you can handle really big jobs that ordinarily would overtax the capacity of a larger bench saw.

Due to its carefully worked out design the COMPANION is unusually sturdy. It will go through the toughest, hardest wood with ease. It has full 2 1/4-inch depth of cut, operates at 3500 R.P.M., and is remarkably free from vibration. We want you to note its many features listed at the top of this page. Note particularly the size and weight. Then read the detailed specifications below. After doing this we know you will decide to add this splendid tool to your shop!

**BASE:** Husky one-piece casting of semi-steel, accurately machined and rigidly braced for maximum strength.

**BEARINGS:** Latest type auto-lubricating bronze bearings make this saw unusually smooth-running. They seal the journals against foreign materials so that they will give many years of perfect service.

**SAW ARBOR:** Extra heavy steel, accurately machined. Will run true and vibrationless under heaviest loads.

**TABLE:** Tilting type, 10x14 1/4 in. Table is heavy, non-warping semi-steel, carefully machined to a smooth flat surface.

**MITER GAUGE:** Sturdy, quickly adjustable. New, easily read scale makes adjustments extremely simple.

**RIP FENCE:** Accurate, well made, and self aligning; exceptionally rugged. When set it "stays put." Can be used on either side of saw blade.

**GUARD:** Fully approved type; meets all safety codes; of rugged construction, mounted on splitter and easily adjusted as to height. Complete with 2-inch machine pulley, guard and splitter and rip fence.

Shpg. wt., 40 lbs.  
99 P 2228...\$10.95

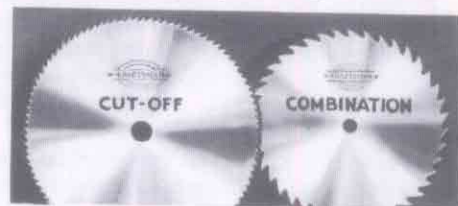

### 7-In. Cut-Off Saw

Special analysis saw steel, carefully heat treated. 1/2 or 3/8 inch center hole. State size. Shpg. wt., 1 lb.

9 P 4921...\$1.00

### 7-In. Combination Saw

Rip, cross cut or miter saw. 1/2 or 3/8-in. hole. Specify diameter and center hole size. Shpg. wt., 10 oz.

9 P 4936...\$1.00



### 4-In. Dado Saws

2 outside saws, 6 chippers. 1/2-in. hole. Shpg. wt., 13 oz.

9 P 4887 — Complete...\$2.25

9 P 4883 — Outside Dado Saw, Shpg. wt., 6 oz...55c

9 P 4880 — Inside Chipper, Shipping weight, 3 ounces...25c

### 5 1/2-In. Dados

2 outside saws, 6 chippers. Specify 1/2-in. center hole. Shpg. wt., 1 lb. 10 oz.

9 P 4888 — Complete...\$3.50

9 P 4884 — Outside Dado Saw, Shpg. wt., 9 oz...89c

9 P 4881 — Inside Chipper, Shpg. wt., 3 oz...30c

View of COMPANION 7-Inch Bench Saw on machine stand with tool-light in position. A most convenient and serviceable arrangement.

ON ORDERS OF \$20 OR MORE  
Easy Terms! SEE INSIDE FRONT COVER

# CRAFTSMAN

REG. U.S. PAT. OFF.

## 8-inch Ball Bearing BENCH SAW

- Price includes accurate, quick-reading, geared-indexing miter gauge, fine quality 8-in. blade, splitter and guard, rip fence, motor pulley and belt.
- Extra-heavy saw arbor runs on highest quality ball bearings.
- Height of saw blade above table is clearly indicated by easily read depth gauge.
- Table measures 16x13 inches, is carefully ground to very fine finish, well ribbed for extra strength, and tilts to 45 degrees.
- Table may be locked instantly at the desired angle.
- Steel trunnions are used as table pivots to insure greater accuracy and longer wear.
- A smooth-operating ball crank handle controls depth of cut through worm gear mechanism.
- Large ball bearing saw arbor is housed in dust-tight, grease-packed chamber.

The CRAFTSMAN Heavy Duty 8-Inch Bench Saw represents an unusual value. It is equipped with crucible alloy steel blade, an extremely accurate geared-indexing miter gauge and ripping fence with laminated hardwood facing, designed by expert power tool men and built of the finest materials obtainable!

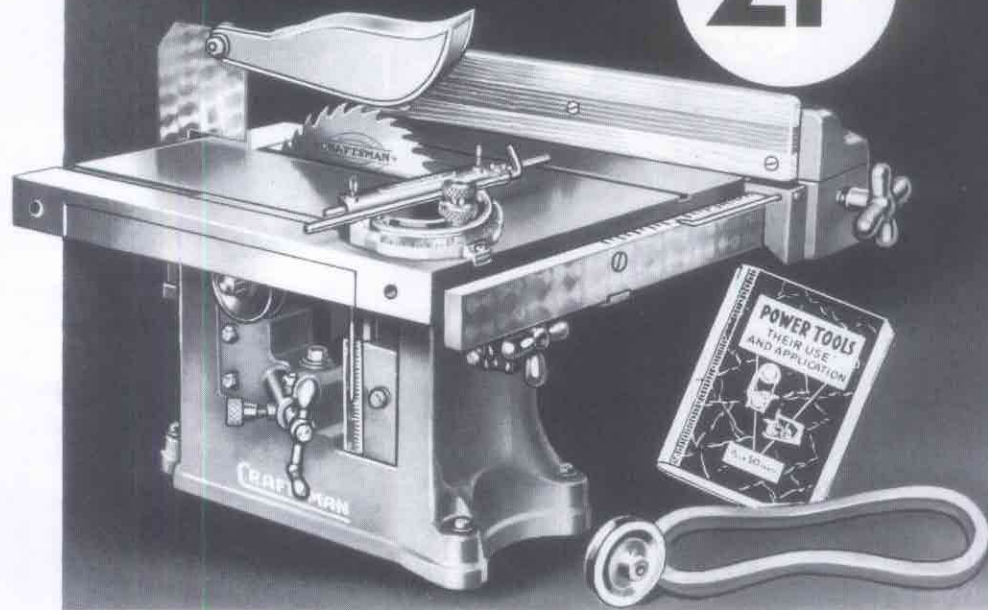

## Correct Design, Quality Materials, Lowest Price

This saw was built up to a standard! To begin with, the design is exactly right for a bench saw of its capacity. Note the heavy semi-steel base, clean cut in every detail of its design. Note also the accessibility of all controls—the complete visibility of its depth gauge, the rugged rip fence and the width of cut graduations. The totally enclosed worm and gear table elevating mechanism, protected from harmful dust, the exceptionally fine ripping fence. These are features to look for when comparing bench saw values!

You'll like the ease and precision with which the table may be tilted to any angle up to 45 degrees. You will appreciate the sturdy ball cranks which control the depth of cut, the adjustable stops in the base so table may be returned to exact horizontal when desired, or instantly and accurately tilted to 45 degrees. In short, you'll be inclined to agree with us that not only is this a fine bench saw for the money... it's also a splendidly designed, carefully built and wonderfully smooth operating piece of machinery.

### SPECIFICATIONS

**BASE:** Heavy gray iron casting, exactly machined. Beautiful Royal Blue finish.  
**TABLE:** Non-warping gray iron, beautifully machined, smoothly ground. Working surface, 16x13 inches. Tilts from 0° to 45°. Equipped with double nested dado inserts.  
**SAW BLADE:** 8-inch high quality crucible steel alloy ripping blade; 3/8-inch center hole.

**RIPPING FENCE:** Rugged and very easily adjusted. Has laminated hardwood face and is exceptionally accurate. Width of cut shown on graduated front support.

**GUARD AND SPLITTER:** Approved design, scientifically constructed for greatest safety and efficiency. Splitter insures free, easy cutting.

**DEPTH OF CUT:** 2 1/4 inches.

**MITER GAUGE:** Precision-built, with quick acting geared-indexing device and easily read scale. Massive construction. Safety design.

**BEARINGS:** Heavy duty. Sealed and grease packed ball bearings on saw arbor.

**TABLE EXTENSIONS:** Are available to increase table size to 16x25 in.  
**MOTOR RECOMMENDED:** 1/2-H.P. COMPANION Ball Bearing Motor No. 99 P 5607 on page 31.

Complete with 8-inch saw blade, geared-indexing miter gauge, rip fence, saw guard and splitter, 39-in. "V" belt, 4-in. "V" belt motor pulley and 72-page fully illustrated instruction book. Shipping weight, 84 pounds.

99 PM 2231..... \$21.95

At the right is shown the CRAFTSMAN 8-Inch Bench Saw on machine stand with machine light in position, all ready to use.

### COMPANION Machine Stand

Rigid and rugged. Size of top, 10x21 in. Height, 31 in. Complete with all necessary bolts and fittings. Shpg. wt., 33 lbs.

99 P 2719..... \$4.25

### COMPANION Tool Light

Easy to attach. Throws the light on the work—extra large reflector keeps light out of your eyes. Has 15-in. flexible neck; over all 23 in. Fitted with clamps, also drilled for bolting to machine. Shpg. wt., 2 lbs.

9 P 2264..... \$1.45

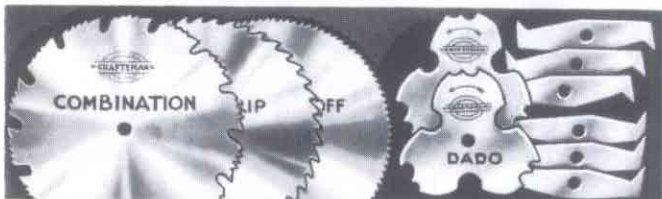

### High Grade 8-In. Circular Saws

Be sure to specify 3/8-in. center hole, and diameter of saw wanted. Shpg. wt., each, 13 oz.

9 P 4939—CRAFTSMAN Hollow Ground Combination. Not Illustrated..... \$3.25

9 P 4936—CRAFTSMAN Plain Tooth Combination. Not Illustrated..... \$1.45

9 P 4938—FULTON Combination..... 1.45

9 P 4928—CRAFTSMAN Rip..... 2.15

9 P 4924—FULTON Rip..... 1.35

9 P 4927—CRAFTSMAN Cut-Off..... 2.15

9 P 4923—FULTON Cut-Off..... 1.35

### CRAFTSMAN 5 1/2-In. Dado Saws

Two carefully ground outside saws with 6 chippers. Accurate and easy cutting in all woods. Specify 3/8-in. center hole.

9 P 4889—Complete. Shpg. wt., 2 lbs..... \$3.50

9 P 4884—Outside Dado Saw only. Shpg. wt., 9 oz..... 89c

9 P 4881—Inside Chipper only. Shpg. wt., 4 oz..... 30c



### Geared-Indexing Miter Gauge

Accurate, easy reading. Takes the guesswork out of cutting miters; just dial the angle desired.

9 P 2248—For saws on pages 2 and 3. Bar, 3/8x3/8 in. Shpg. wt., 6 lbs..... \$2.50

9 P 2249—Bar, 3/8x3/8 in. Shipping weight, 7 pounds..... \$3.00

### Front Extension Bars

For bench saw above. Easily attached. Readily removed so as not to interfere with normal operation. Filled in with strips or rollers they make it very easy to handle the widest cross cut. Shipping wt., 4 lbs.

9 P 2243..... \$1.50

### Extension Tables

For CRAFTSMAN 8-Inch Bench Saw above. Increases saw table size to 16x25 in.; enlarges its capacity. Strongly made and complete with long graduated front bar, ready to attach. Shipping weight, 26 pounds.

9 P 2241 Pair..... \$6.25

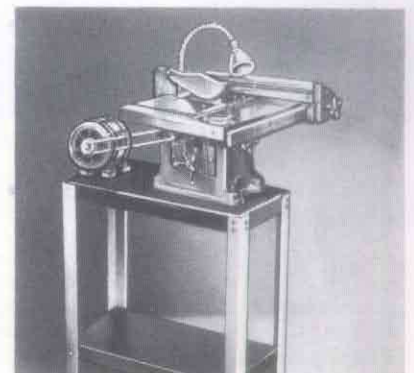

Easy ON ORDERS OF 120 OR MORE Terms! SEE INSIDE FRONT COVER

# Outstanding

# \$29<sup>95</sup>

Less Motor

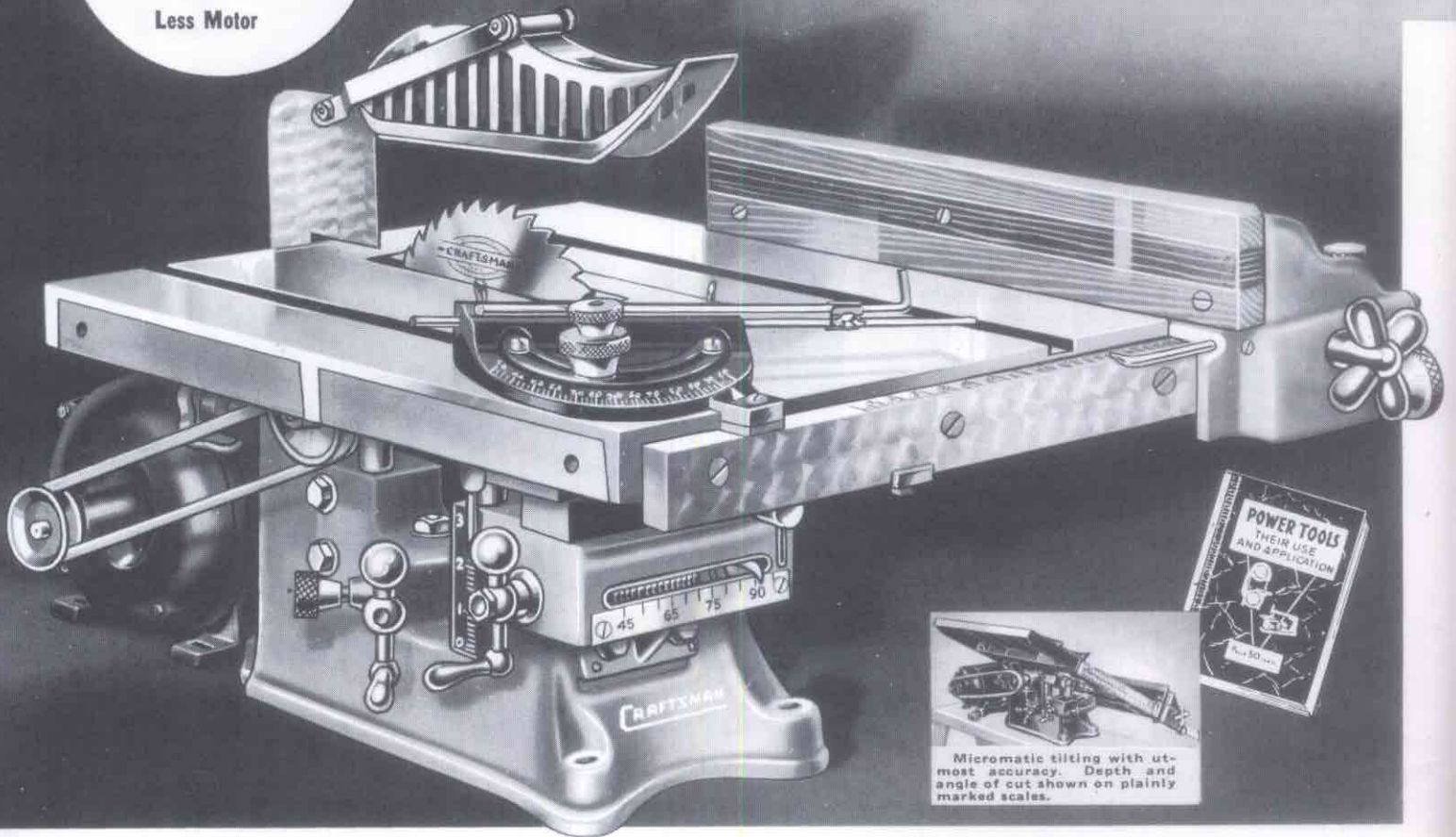

Micromatic tilting with utmost accuracy. Depth and angle of cut shown on plainly marked scales.

## Lowest Price Ever Quoted for a Bench Saw of This Quality!

### Extension Tables

These two 8-inch wide extension tables increase the working surface of the CRAFTSMAN Heavy Duty Bench Saw to 31 x 19 inches. Be sure to order them when you order your saw! With the two 8-inch tables is included an extra long graduated steel bar, which shows width of cut, for attaching to front of saw to support ripping fence. Shipping weight, 32 pounds.

9 P 2175.....\$7.95

### Front Extension Bars

Desirable when cutting wallboard, plywood, etc. Filled in with wood or rollers they make it very easy to handle the widest cross-cut. Readily removed, they impose no restriction on the normal easy operation of the saw, a feature that is well worth your consideration. Length of bars, 14 inches. Complete ready to attach. Shipping weight, 4 pounds.

9 P 2243.....\$1.50

This unquestionably is America's most outstanding bench saw! First, because point for point and feature for feature it outranks in design, in construction and in quality of materials saws that sell for as high as \$60.00. Second, because it is priced far lower than any saw of similar quality. We invite you to compare this saw, feature for feature, with the best saws now being offered. No one but Sears has sufficient sales volume to produce or offer such a saw at such a low price. Only years of experience, a strong organization and the comments of thousands of customers could produce such a saw. You can select it with a feeling of absolute certainty that you are getting MORE FOR YOUR MONEY than can be obtained in any saw anywhere else. It is a REAL Bench Saw!

# Among Quality Power Tools Regardless of Price! . . .

Designed  
for the  
Expert!

## CRAFTSMAN

REG. U. S. PAT. OFF.

Heavy Duty  
8-Inch  
Bench Saw

### The First Choice of Professional Craftsmen

- Saw arbor runs on heavy precision type ball bearings.
- Unusually rugged base of close grained gray iron insures steadiness and freedom from vibration.
- Depth of cut and tilt of table under instant, easy control by means of individual ball crank handles.
- Large, easily read scales indicate depth of cut and angle of tilt.
- Large table (15x19 inches) is beautifully machined and ground to a smooth finish and is grooved for miter gauge.
- Removable nested dado insert enables saw to be converted to a sander or metal cutting tool.
- Extra sturdy ripping fence has laminated hardwood face.
- Table attached to base by alloy steel trunnions insures accurate angle cuts . . . better than any other means of support.
- Exclusive Micromatic Tilting Device gives accurate and effortless control of angle of table from 0° to 45°.

A good bench saw is the key tool in every shop. It was our ambition to offer bench saw users the finest tool that could be built. Price to be determined later. Quality to be the first consideration. To better the best that any manufacturer has thus far produced was our goal. That we succeeded well you can easily be assured by studying the features and specifications of the CRAFTSMAN 8-Inch Bench Saw! We believe that today it is years ahead of all competing saws in completeness, strength, accuracy, workmanship and finish. When working with hard, tough, close-grained woods at top speed it is singularly free from vibration. It is exceptionally clean in design, free from "gadgets" and fragile parts likely to get out of order. In fact, it is so husky in appearance and so sturdily built throughout that in all but size it might be mistaken for a big production type saw such as is used in shops or mills and often costing several hundreds of dollars!

#### SPECIFICATIONS

**BASE:** Sturdy, accurate machined gray iron.

**TABLE:** Heavy, non-warping, exceptionally well ribbed and ground to very smooth finish. Tilts from 0° to 45° by means of positive Micromatic Tilting Device operated by convenient ball crank handle.

**ARBOR:** Tough alloy steel, carefully machined to accurate dimensions and running in precision type ball bearings sealed in oil.

**ELEVATING MECHANISM:** Fully enclosed as a protection from abrasives, and controlled by worm gearing and ball crank handle.

**RIP FENCE:** Protectively faced with laminated hardwood. Very accurate; fitted with indicator reading from graduated scale on front of saw. Fine micrometer adjustment for close work.

**GUARD:** Latest approved type, fully automatic.

**MITER GAUGE:** Highly efficient, extremely accurate and easily set to precise angle desired. Geared and self indexing.

**DEPTH OF CUT:** Full 2¼ inches.

**MOTOR REQUIRED:** ⅓-H.P. No. 99 P 5607 on page 31.

**EQUIPMENT INCLUDED:** Ripping fence, guard and splitter, geared miter gauge, 8-inch rip saw blade, motor pulley, belt and instruction book.

**99 PM 2233**—CRAFTSMAN Heavy Duty 8-Inch Bench Saw, complete as described (see equipment specifications below) and illustrated but without motor. Shipping weight, 99 pounds. . . . . \$29.95

**99 PM 2235**—Same as above but with ⅓-H. P. COMPANION ball bearing motor, 110-120 volt, 60-cycle A.C. Shpg. wt., 129 lbs. . . . . \$39.90

**99 P 2719**—COMPANION Machine Stand. For above saw. Size of top, 10 in. x 21 in. Height, 31 in. Complete with all necessary bolts and fittings. Shipping weight, 33 pounds. . . . . \$4.25

**9 P 2264**—COMPANION Tool Light. Easy to attach. Throws the light on your work—extra large reflector keeps it out of your eyes. Has 15-in. flexible neck. Over all length, 23 in. Fitted with clamp; also drilled for bolting to machine. Shipping weight, 2 pounds. . . . . \$1.45

Easy Terms on orders of \$20.00 or more. See inside front cover.



#### High Grade 8-In. Circular Saws

Be sure to specify ½-in. center hole, and diameter of saw wanted.

**9 P 4927**—CRAFTSMAN Cut-Off Saw. Made from special analysis saw steel, heat treated and hardened. Shpg. wt., 13 oz. \$2.15

**9 P 4923**—FULTON Cut-Off Saw. Saw steel. Set and filed, ready for use. Shipping weight, 13 ounces. . . . . \$1.35

**9 P 4928**—CRAFTSMAN Rip Saw. Highest quality. Accurately set for easy cutting. Shipping weight, 13 ounces. . . . . \$2.15

**9 P 4924**—FULTON Rip Saw. Outstanding Value at Sears low price. Shipping weight, 13 ounces. . . . . \$1.35

**9 P 4939**—CRAFTSMAN Hollow Ground Combination Saw. For cross cutting, ripping or mitering. Shpg. wt., 13 oz. . . . . \$3.25

**9 P 4936**—CRAFTSMAN Plain Tooth Combination Saw. Not illustrated. Shipping weight, 13 ounces. . . . . \$1.45



#### Grinding and Metal Cutting Wheels

**9 P 2242**—High quality steel abrasive disc wheel, 8½ in. in diameter, for use on CRAFTSMAN 8-Inch Bench Saw. Shpg. wt., 4 lbs. 4 oz. \$1.50

**9 P 2240**—Pkg. of six 8½-in. sanding discs, coarse and fine, to fit above wheel. Shipping weight, 10 ounces. . . . . 75c

**9 P 6470**—8-inch metal cutting wheel for use in CRAFTSMAN 8-Inch Bench Saw. Specify ½-in. hole. Shpg. wt., 1 lb. 14 oz. . . . . \$1.00

#### CRAFTSMAN 5½-in. Dado Saws

Two carefully ground outside saws with 6 chippers. Specify ½-in. hole.

**9 P 4889**—Complete. Shipping weight, 2 lbs. . . . . \$3.50

**9 P 4884**—Outside Dado Saw only. Shipping wt., 9 oz. . . . . 89c

**9 P 4881**—Inside Chipper only. Shipping weight, 3 ounces. . . . . 30c

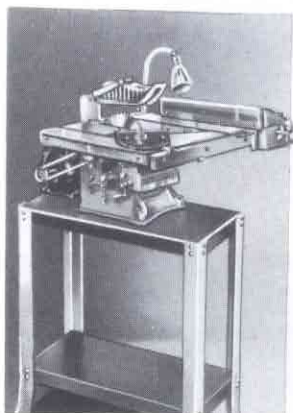

CRAFTSMAN 8-Inch Bench Saw on machine stand, with machine light in position, all ready to use. A most convenient and serviceable arrangement.

See Page 35.

# CRAFTSMAN

REG. U. S. PAT. OFF.

## Retractable Saw With Tilting Arbor

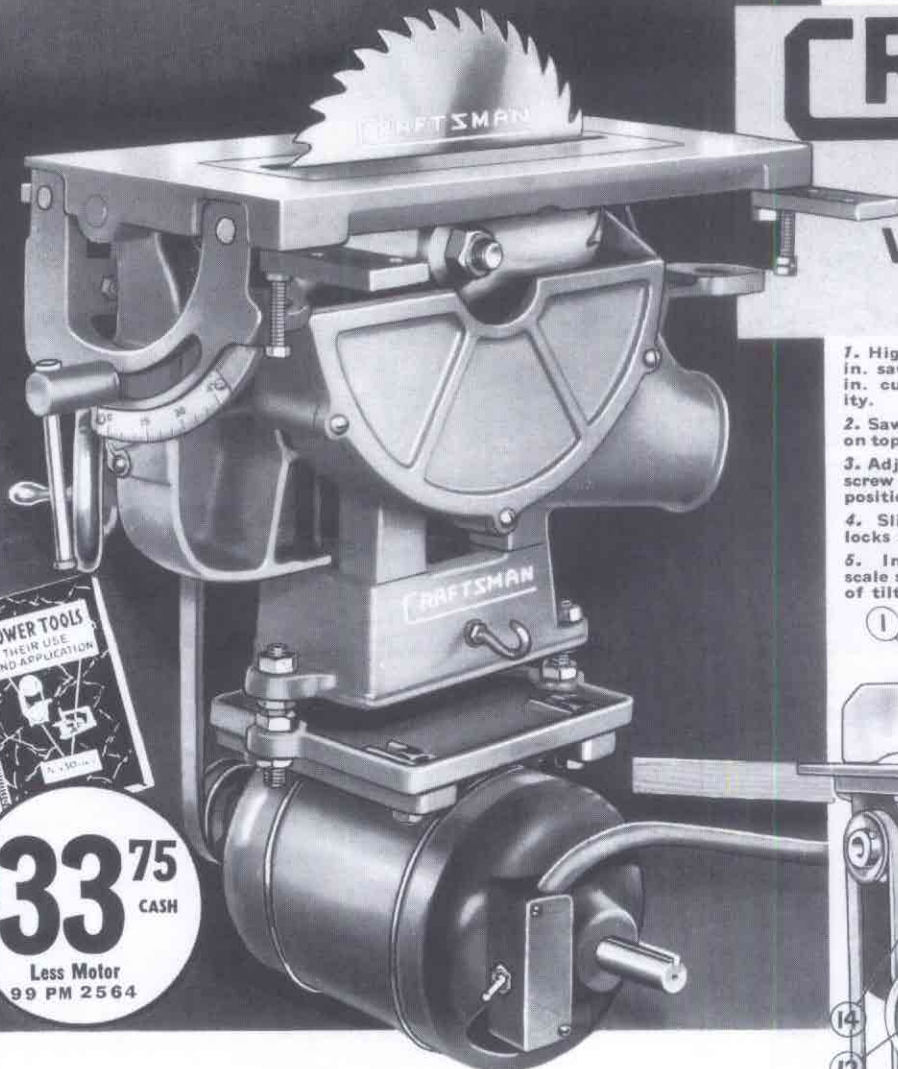

1. High quality 10-in. saw has full 3-in. cutting capacity.
2. Saw unit hinges on top plate.
3. Adjustable stop-screw for vertical position.
4. Slide bar bolt locks at any angle.
5. Indicator and scale show position of tilting arbor.

6. Hand wheel for raising and lowering saw and motor unit.
7. Plainly marked gauge shows depth of cut.
8. Simple, positive adjustment for belt.
9. Switch for controlling motor.
10. Extra-powerful 1/2-H.P. 110-120-volt 60-cycle A.C. motor.

11. Heavy duty "V" belt included with saw.
12. Worm gear mechanism for elevating saw blade.
13. Latest type of approved guard for protection of user.
14. Saw arbor runs in precision type ball bearings, insuring smooth, friction-free operation.

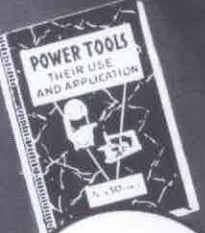

**\$33<sup>75</sup>**  
CASH  
Less Motor  
99 PM 2564

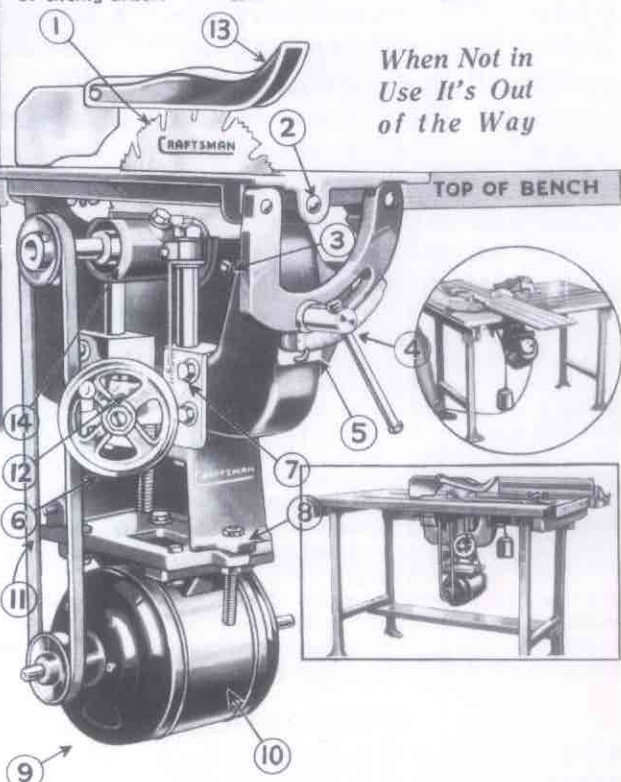

### Ample Capacity for Any Job!

When your shop is equipped with a CRAFTSMAN Retractable Saw you not only have ample capacity for any job you might want to handle but you also have the tremendous advantage of being able to use every inch of your bench top for other work! For the blade can be instantly be raised or lowered below the table surface leaving the entire work bench top free for other use. The saw guard is removable. Height of saw blade above table is controlled by hand wheel and worm gear. When raised the blade may be tilted to any desired angle up to 45°. All of this is accomplished by means of easily operated hand wheels and slide bar bolts. Indicators tell you exact height—precise degree of tilt!

## NEW - Revolutionary - a Space Saver

Carpenters, cabinet-makers, contractors, box makers, home craftsmen and many others have found the CRAFTSMAN Retractable Saw the handiest tool they ever owned. Precision type ball bearing arbor is fully protected from dust and grit, regardless of materials being cut. One of the most useful tools you could possibly own! The complete outfit includes the tilting arbor saw unit, motor base, belt, pulleys, safety guard and splitter, ripping fence with micrometer adjustment, 30-inch steel support bar graduated in fractions of an inch, accurate miter gauge, counterweight and pulley. This outfit comes to you all ready for mounting in

your own work bench. Fine 72-page instruction book included. Use 1/2-H.P. or 3/4-H.P., 3450 R.P.M. motors described on page 31.

99 PM 2564—CRAFTSMAN Retractable Saw unit and accessories listed at left without bench or motor. Shipping weight, 105 pounds.....\$33.75

99 P 2566—Laminated maple table top, 30x48x1 1/4 in., with two metal edged grooves for miter gauge. Slotted for mounting above unit. Shpg. wt., 60 lbs.\$12.95

99 PM 2722—Steel bench legs for above table top. Shipping weight, 34 pounds.....\$4.95

99 PM 2568—Complete outfit, including saw, accessories, bench and legs, but without motor. Shpg. wt., 198 lbs.\$49.95

99 PM 2570—Complete outfit with bench, legs, accessories and 1/2-H.P. 110-120 volt, 60-cycle A.C. motor, as shown above. Shipping weight, 230 pounds.....\$69.50

Easy Terms!  
ON ORDERS OF \$20 OR MORE SEE INSIDE FRONT COVER



### High Grade 10-In. Circular Saws

Be sure to specify 3/8-in. center hole, and diameter of saw wanted.

- 9 P 4927—CRAFTSMAN Cut-off Saw. Shpg. wt., 2 lbs. \$2.69
- 9 P 4923—FULTON Cut-Off Saw. Shpg. wt., 2 lbs. 1.65
- 9 P 4928—CRAFTSMAN Rip Saw. Shpg. wt., 2 lbs. 2.69
- 9 P 4924—FULTON Rip Saw. Shpg. wt., 2 lbs. 1.65
- 9 P 4939—CRAFTSMAN Hollow Ground Combination Saw. For cross cutting, ripping or mitering. Shpg. wt., 2 lbs. \$4.25
- 9 P 4938—FULTON Flat Ground Combination Saw. Shipping weight, 2 pounds.....\$1.85

### CRAFTSMAN

### 5 1/2-In. Dado Saws

- Two carefully ground outside saws with 6 chippers. Specify 3/8-in. center hole.
- 9 P 4889—Complete. Shipping weight, 1 pound 8 ounces.....\$3.50
  - 9 P 4884—Outside Dado Saw only. Shipping weight, 9 ounces.....89c
  - 9 P 4881—Inside Chipper only. Shipping weight, 4 ounces.....30c

### COMPANION Tool Light

Has 15-inch flexible neck that enables you to throw the light just where you want it, on your work... extra large reflector keeps light out of your eyes. Easy to attach to bench or machine. Over all length, 23 inches.

- Complete with reflector, mounting bracket and cord, plug and switch. Shipping weight, 1 lb. 12 oz. 9 P 2264.....\$1.45

# CRAFTSMAN

REG. U. S. PAT. OFF.

## "Balanced Action" Jig Saw Full 14-inch Throat

- Extra-heavy "bridge-truss" type frame.
- Perfectly balanced action.
- Oil-tight dustproof crank case.
- Carefully-fitted extra-long bearings.
- Built-in sawdust blower keeps work clean and work lines visible.
- Adjustable for light or heavy sawing.
- Blade vises can be turned through 90 degrees to cut very long pieces.

Believing it was possible to offer a finely-built, extremely sturdy jig saw with full 14-inch throat for about one-half what such tools usually sell for, Sears offered this husky, "bridge-truss" type saw. Included in its construction are many features to be found only on expensive saws. The remarkable popularity of this CRAFTSMAN Jig Saw proved that thousands of home craftsmen wanted such a tool!

Built strong enough for professional work—that's why it handles the usual run of homecraft jobs so easily. Scroll sawing, jig sawing, pattern making, toy building and a hundred similar types of work are easily handled by this fine machine! You can use jig or fret saw blades in it, from 5 to 6½ inches in length.

At its recommended speed of 800-1000 R.P.M. this tool is remarkably smooth and efficient. Fitted with 9x9-inch tilting table that is adjustable from 0° to 45°. Accurate scale gives precise angle of tilt. If you want to saw copper, aluminum, as well as wood—go ahead. With the proper blades you can handle metals as easily as wood! Nothing skimped—nothing omitted that would make the saw work better, do more, last longer. All in all it's the finest medium sized jig saw we've ever seen! We know you'll want one for your shop. Fully illustrated 72 page book of instructions included.

Shipping weight, 38 pounds.

99 P 2261

\$10.95

Easy ON ORDERS OF  
Terms 120 OR MORE  
SEE INSIDE  
FRONT COVER



### VIEW SHOWING TABLE TILTED

Table is adjustable from 0 to 45 degrees. Note the rugged table support and the graduated scale which shows exact angle of tilt.

### HANDY FRET SAW ATTACHMENT

For those extra-fine 5-inch fret saw blades so widely used in jig-saw puzzle work or for any job requiring an extremely thin saw we recommend the use of this attachment for your CRAFTSMAN 14 or 24-inch Jig Saw. Complete with instructions for attaching.

Shipping weight, 8 ounces.

9 P 2269

\$1.95

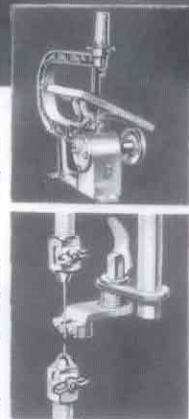

## Sears Accessories Are of the Highest Quality

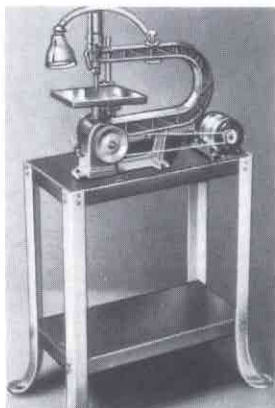

CRAFTSMAN 14-In. Jig Saw on machine stand, with machine light in position, all ready to use. A most convenient, serviceable arrangement. See pages 34-35.

Because of the leadership enjoyed by Sears in the power tool field—a leadership gained by designing and building QUALITY TOOLS ONLY—we have made it our policy to offer only the highest quality accessories for these tools. As a result of this wise policy you can order any accessory for your shop from Sears secure in the knowledge that you are getting the finest of its kind that it is possible to obtain—at a substantial saving in price. Any power tool, no matter how expensive it may be or how carefully designed and built, is at the mercy of

some comparatively inexpensive accessory. Should such an accessory fail at a crucial time it may mean lost profit, work spoiled, time wasted. Belts that slip or break—set screws that fail to hold—little things that are not the finest obtainable—are a poor investment. When you buy accessories at Sears you get SATISFACTION. You will find the accessories listed in this book are built to the highest standard, that they will give long, trouble-free service and operate with a saving of power. Sears accessories are not only the best but they save you money!

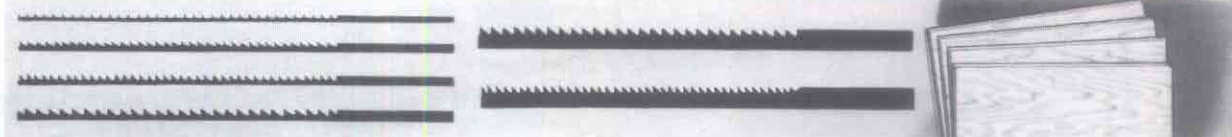

### CRAFTSMAN FRET SAW AND JIG SAW BLADES

Fret saw blades. 5 inches long. 8 in a package.					Jig saw blades. 6 inches long. 6 in a package.						
	Teeth	Thickness	Width	(Pkg. of 8)	Shpg. Wt. Pkg.		Teeth	Width	(Plain End)	(Pin End)	Shpg. Wt. Pkg.
9 P 2692	22 to in.	.007 in.	.032 in.	19c	1 oz.	9 P 2700	10 to in.	1/8 in.	15c	15c	1 oz.
9 P 2693	18 to in.	.010 in.	.045 in.	19c	1 oz.	9 P 2701	15 to in.	1/8 in.	15c	15c	1 oz.
9 P 2694	16 to in.	.010 in.	.056 in.	19c	1 oz.	9 P 2704	10 to in.	1/8 in.	15c	15c	1 oz.
9 P 2695	18 to in.	.010 in.	.070 in.	19c	1 oz.	9 P 2705	15 to in.	1/8 in.	15c	15c	1 oz.

9 P 2708—Assorted Saber Blades, For Wood or Metal. Finest quality. For use in jig saws with proper attachment. Shipping weight, 1 ounce. Package of 3.....19c

### 3-Ply Wood

For jig saw work or panel use. 3 large pieces of high grade plywood, each approximately 3/8 in. thick, 18 in. wide and 24 in. long. Will not crack or split. Shipping weight, 5 pounds 4 ounces.

9 P 2924

# CRAFTSMAN

REG. U. S. PAT. OFF.

## HEAVY DUTY Full 24-Inch

### Beyond All Doubt the Finest Jig Saw You Can Buy!

- Cuts to center of 48-inch circle and handles material up to 4 in. thick.
- Universal chuck takes blades of every size and type up to 1/2 inch width.
- Driving mechanism runs in bath of oil, providing positive and adequate lubrication.
- Adjustable upper guide permits of use of blades from 5 1/2 in. long up to 14 in. or more in length.
- Roller guide is mounted on hardened steel pins. May be installed on under side of table for saber sawing.
- Upper arm is removable, providing unlimited capacity.
- May be equipped to perform dovetailing, mortising, shaping, carving and routing operations.
- Powerful sawdust blower is built into head. Directs stream of air on work at all times.
- 12x12-inch table fitted with soft metal insert.
- Table tilts to 45°, with degree of tilt clearly indicated on accurate quadrant.
- Operates at 4 speeds for varying types of work: 1750, 1295, 926 and 644 R.P.M.
- Blade vises and blade may be revolved through 90 degrees to rip long pieces.

### SPECIFICATIONS

**TABLE:** Made of heavy gray iron, precision ground, provided with soft metal insert around blade. Insert is removable for use of machine files. Table also is provided with threaded holes in the 12x12-inch top for attaching shaper fence used with high speed router attachment. In addition to tilting 45° to right or left, table may be tilted 5° front or back, an advantage in die filing, marquetry and pattern work.

**BASE:** Heavy gray iron base, streamlined, and unusually rigid. Combines maximum strength with minimum weight. Section where upper arm is attached is carefully ground for accuracy. Base is provided with slots for attaching motor.

**ARM:** Beautifully designed to harmonize with base and made of close grained gray iron, accurately machined to fit base and also at small end to hold standard head or router assembly. Built to insure absolute minimum of vibration. Arm may be swiveled to right or left for dovetailing with router. Arm is readily removable, being held in place by two bolts. A knurled pin securely locks arm in normal sawing position.

**THROAT:** Full 24-inch capacity, even when sawing material which is 4 inches thick.

**STROKE:** 1-inch. By means of adjustment in the head, blades from 5 1/2 in. up to 14 in. or more in length may be used.

**CUTTING CAPACITY:** Distance from table to upper blade vise, 4 1/2 in. Chucks may be turned to saw at any angle.

**LUBRICATION:** Entire driving mechanism operates in a bath of oil, and is fully enclosed. Main shaft and lower guide receive lubrication from this source. Only other lubrication required is a few drops of oil occasionally on upper guide.

**MOTOR Recommended:** 1/2-H.P. (1/4-H.P. for light service), 1750 R.P.M.

**HOLD DOWN AND ROLLER GUIDE:** Adjustable spring hold down prevents work from being lifted on up stroke. Roller guide, mounted on hardened steel pins, provides necessary backing for blade. For saber sawing guide may be attached to under side of table.

**CHUCKS:** Universal type, hold flat, round or angular sections firmly. Chucks may be turned to saw at any desirable angle. Small vises for fret work are available at slight extra cost. (Fret saw vises are illustrated on page 7.)

**CANVAS BOOT:** Completely encloses the upper part of the lower guide at all times, preventing abrasive dust from getting into bearings or oil supply. An absolute necessity when filing or sanding. An exclusive and valuable feature.

## It has the flexibility and strength

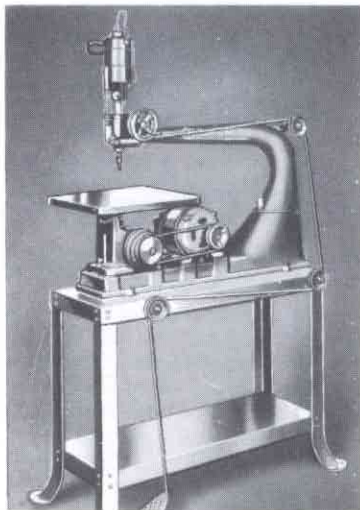

The above outfit represents an ideal combination. . . . The CRAFTSMAN 24-Inch Jig Saw with router head offers the widest possible range of operations that could be combined in one machine—jig sawing, filing, routing, carving, shaping, dovetailing, fret saw work, saber sawing—almost every essential shop operation. The machine stand has a 10-inch x 34-inch top, is 31 inches high and provides a clean convenient mounting. See catalog No. 99 PM 2266 listed on opposite page for price of complete outfit.

This big, powerful, 24-inch CRAFTSMAN Jig Saw was designed for real production work. It has truly remarkable flexibility in that you can do many kinds of work on it. It has the rugged strength combined with careful, conscientious manufacture that enables it to keep going all day long, day after day. It has a wide range of speeds, which is important for the many kinds of work which this tool readily performs. It works equally well with the smallest fret saw blade and with blades a full half inch wide. You can also use machine files

in the CRAFTSMAN Jig Saw. It will saw nonferrous metals easily and accurately. Mechanically it is as close to power tool perfection as a jig saw can be made. Every detail of its construction reflects the care, the designing skill and the striving for accuracy that distinguish Sears Power Tools. Read the features and specifications above. Note the tremendous versatility of this saw, with its various attachments. Then order one for your shop! You will find it the best power tool investment you ever made!

### High Speed Router Attachment

One of the most remarkable features of the CRAFTSMAN 24-Inch Jig Saw is that it will accommodate high speed router attachment which takes the place of the regular head on the extension arm. This attachment is a complete unit in itself—a vertically mounted ball bearing motor which operates at 17,000 R.P.M. and is carried in a rugged housing which encases the steel quill and ball bearing spindle. The motor and quill unit may be raised or lowered by a hand wheel or by foot treadle connected to unit by cable. With this high speed router attachment you can do the most intricate sort of routing, carving and grinding, as well as shaping, mortising and tenoning. You can add a dovetail jig and router at small cost and also do perfect dovetailing. In short, there is scarcely an operation that can be handled on the most expensive production machine which you cannot handle with equal facility and accuracy on the CRAFTSMAN 24-Inch Jig Saw.

Complete assembly consists of 17,000 R.P.M. 110-120-volt A.C.-D.C. motor, foot treadle control, motor bracket with steel quill having milled rack and ball bearing spindle, pulleys and set of routing attachments. It takes the place of regular jig saw head, by loosening one bolt. Fits any CRAFTSMAN 24-inch jig saw. Shpg. wt., 35 lbs.

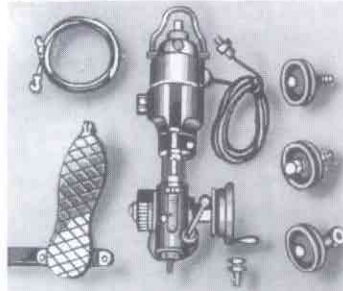

- 9 P 2260—High Speed Router, complete. . . . \$ 31.95
  - 99 P 2642—Router Motor only. Shipping weight, 10 lbs. . . . \$14.95
  - 9 P 2640—Special high speed collet chuck for use with 17,000 R.P.M. router motor and flexible shaft. High quality specially balanced. Supplied in three sizes to accommodate 1/8, 1/4 or 3/8 inch tool shanks. Specify size wanted. Shpg. wt., 6 oz. Each . . . . . 75c
- For routing and carving bits or other accessories see page 14.

### Carving Cutters for Use With High Speed Router

Accurately made high speed cutters of finest quality tool steel. For use with High Speed Router Attachment for CRAFTSMAN 24-inch Jig Saw.



- 9 P 2644—Specify item wanted. Shipping weight, each, 4 ounces.
- |            |            |        |                      |              |           |               |
|------------|------------|--------|----------------------|--------------|-----------|---------------|
| Round Nose | Half Round | Liner  | 3/8 in. Cutter Shank | Button Drill | Hook Tool | Straight Face |
| \$1.50     | \$1.50     | \$1.50 | 35c                  | \$1.50       | \$1.50    | \$1.50        |

# JIG SAW Capacity

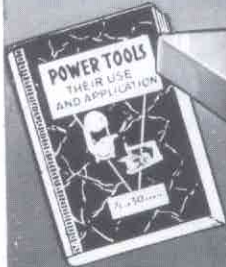

**\$22<sup>50</sup>**  
CASH  
Less Motor  
99 PM 2262

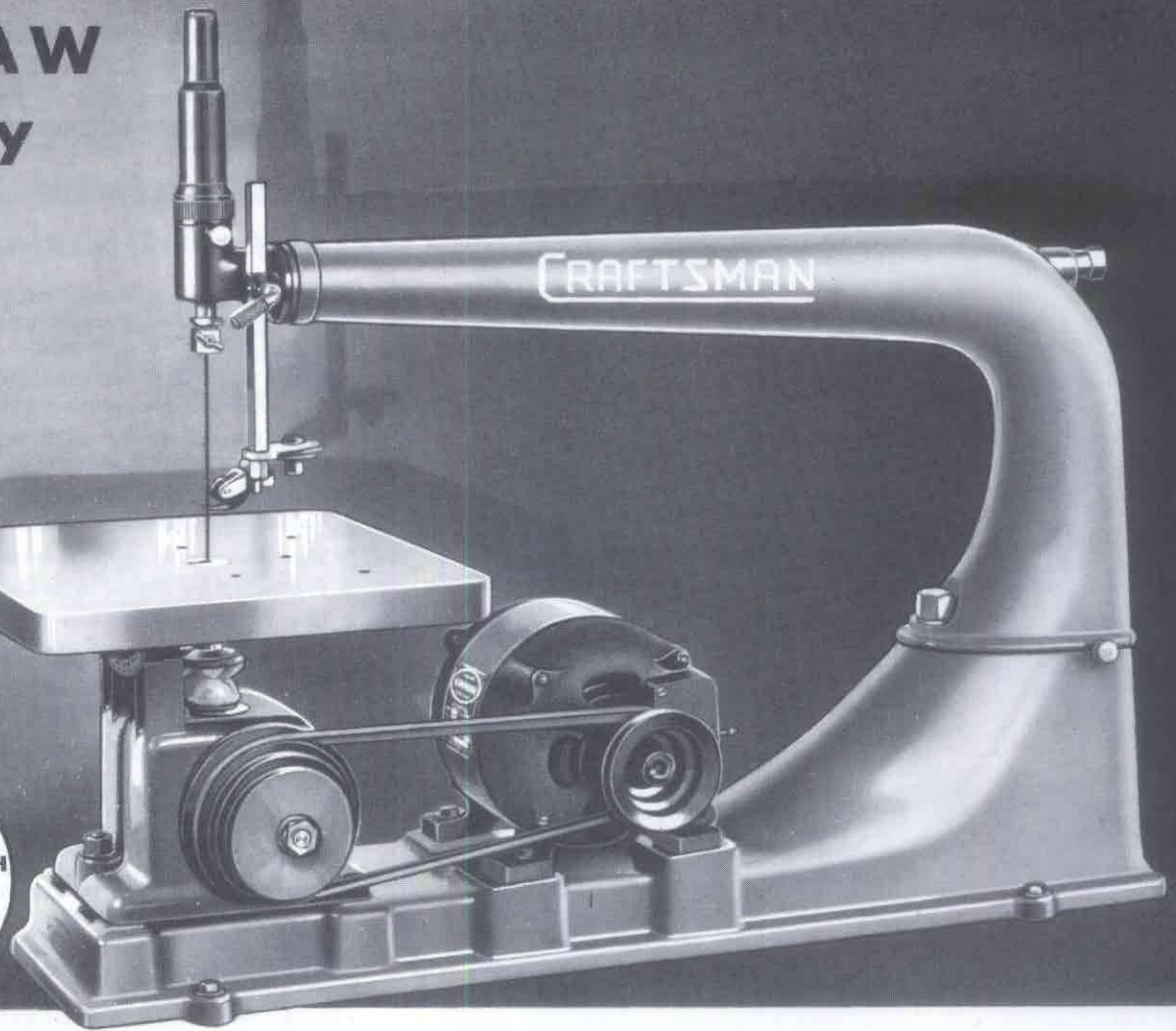

## needed for production work

Here's the new leader in the jig saw field. Comparison will reveal it to you as a worthy leader in quality, style, workmanship, design, versatility and mechanical excellence. This big 24-Inch CRAFTSMAN Jig Saw has everything any jig saw ever had and MORE! It has many features NO OTHER SAW EVER HAD. Beautifully streamlined base and detachable arm! Note how the motor is tucked away below the table level. Note that the saw operates at 4 speeds without shifting motor... that it has a positive action piston type blower built into the head... a canvas boot on the lower guide... a completely enclosed crankcase with all moving parts running in an oil bath... universal chucks that hold every type of blade, at any desired angle, from zero to 360 degrees... a carefully machined gray iron table 12 inches square! Note also that you can use saber blades and machine files on this saw... that you can add a high speed router attachment that will enable you to do carving, routing, shaping and mortising... that you can tilt the table not only to the right or left but to the front or back as well... So carefully designed and accurately built that it is practically vibrationless. Both crank shaft and drive pulley are perfectly balanced. Order it today—utilize its power and versatility for the hardest sort of work. You'll find that we haven't told you half the story of its high quality and performance! Complete with 4-step driving pulley, 4-step motor pulley, belt, and 72-page fully illustrated book of instructions.

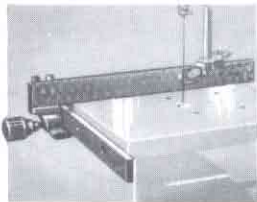

**9 P 2268**—Rip Fence and Front Supporting Bar with fittings to attach through holes ready drilled in jig saw table. Shipping weight, 8 pounds..... **\$2.25**

**99 PM 2262**—CRAFTSMAN 24-Inch Jig Saw, without motor. Shipping weight, 104 pounds..... **\$22.50**

**99 PM 2267**—CRAFTSMAN 24-Inch Jig Saw with 1/2-H.P. ball bearing COMPANION 110-120-volt, 60-cycle A.C. Motor. Shipping weight, 122 pounds..... **\$32.50**

**99 PM 2266**—CRAFTSMAN 24-Inch Jig Saw with 9 P 2260 Router Head and attachments, 10x34x 31-inch machine stand and 1/2-H.P. KENMORE 110-120-volt, 60-cycle A.C. Motor. Shipping weight, 191 pounds..... **\$64.75**

**9 P 2755**—Special Replacement Belt, 32x3/4 in. Shipping weight, 4 ounces..... **35c**

FOR BLADES SEE PAGE 7

**Easy Tools**  
ON ORDERS OF  
20 OR MORE  
SEE INSIDE  
FRONT COVER



Router head assembly tilted for spindle carving. Scale on head shows angle of tilt.

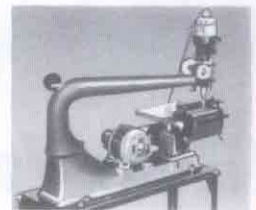

Illustrating dovetail attachment. (Page 15.) Operates smoothly and accurately.

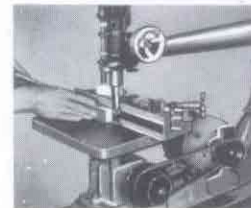

Shaping guard and guide in use; holes for attaching are ready drilled and tapped.

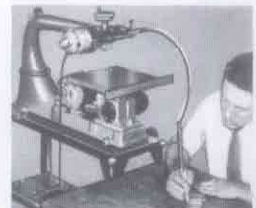

Showing high speed flexible shaft in use with router head for die work.

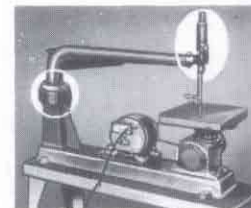

Modernize previous models. **9 P 2271**—Raising Block for Arm. Wt., 5 lbs. **\$1.50**  
**9 P 2270**—New Head Assembly. Wt., 5 lbs. **\$2.45**



Produce those beautiful carvings you admire. Carving operations are accomplished with ease, speed and smoothness before unknown.



### Machine Files for Jig Saw Use

Use these handy files in your CRAFTSMAN 24-Inch Jig Saw to replace tedious hand filing. Made of special file steel and will give superior service. Have 3/16 inch shanks. Shipping weight, each, 1 ounce.

**9 P 2737**—3 Square File..... **48c** | **9 P 2738**—Round File..... **48c** | **9 P 2740**—Pillar File..... **48c**  
**9 P 2742**—Half Round File..... **48c** | **9 P 2739**—Crochet File..... **48c** | **9 P 2741**—Square File..... **48c**

# COMPANION

10-inch Tilting Table Band Saw  
at a Money-Saving Price

**\$15<sup>75</sup>**

- Exceptionally sturdy one-piece iron frame insures smooth, easy operation.
- Fitted with highest quality easy running bronze wheel bearings.

- Upper guide fitted with high grade ball thrust bearing.
- Cuts to center of 20-inch circle. 10-inch balanced safety type wheels.
- Handles stock up to 4 inches thick.
- Protected by latest approved guards.
- Sturdy, adjustable top wheel turret.
- Table tilts to any angle up to 45°. Angle shown on scale.

## SPECIFICATIONS

**FRAME:** Heavy one-piece close-grained gray iron, well braced and designed to provide large surfaces for alignment and for bearings. This insures smooth operation.

**WHEELS:** Big, full 10-inch size safety type, rubber tired for silence and perfect blade traction. Tension and alignment fully provided for in the design of adjustable top turret. Adjustments so easily made that even the inexperienced operator can have his saw blade running smooth and true, at the precise tension necessary for any kind of work.

**BEARINGS:** Oversize, bronze. Will give many years of free-running, accurate service.

**TABLE:** Its 9 $\frac{1}{2}$ x9 $\frac{1}{2}$  inch top is smoothly machined. Is mounted on rugged cradle which is graduated to show angle of cut from zero to 45 degrees. Center of table provided with soft metal insert to protect blade. A turn of the quick-acting lock and the table may be tilted from 0° to 45°.

**BLADE GUIDES:** Upper guide adjustable for height and is fitted with highest quality ball bearing. Both upper and lower guides designed to keep saw blade running true and free even under heavy cutting.

**DIMENSIONS:** Height, over all, 26 $\frac{1}{2}$  in. Depth, front to rear, 17 in. Maximum width, 9 $\frac{1}{2}$  in.

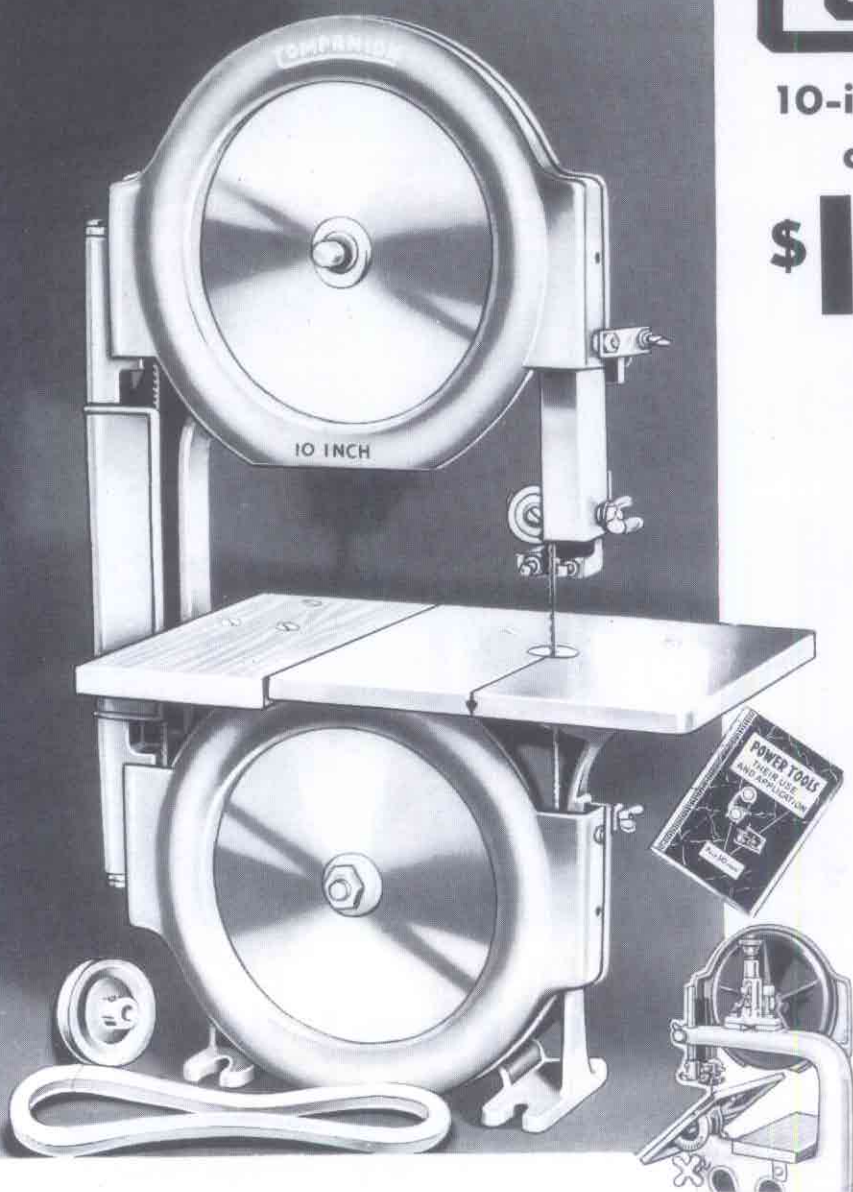

## Best Value at Anywhere Near Our Price!

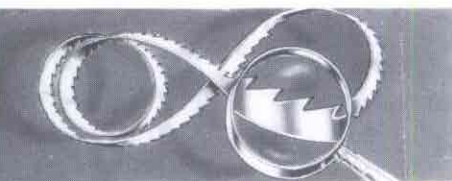
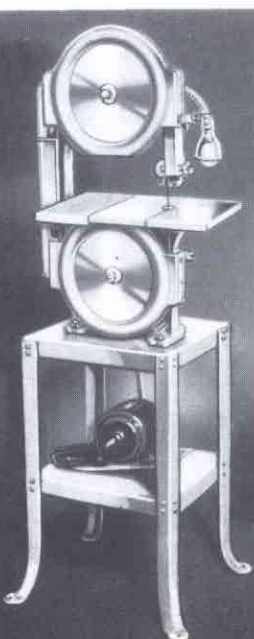

### COMPANION Band Saw Blades

For 10-inch band saw 99 PM 2302. Made of high quality saw steel, carefully tempered and set. Will give long service on all kinds of wood whether hard or soft. Run true, hold their cutting edge longer! Length, 62 in. Furnished in widths of  $\frac{1}{8}$ ,  $\frac{1}{4}$  or  $\frac{3}{8}$  in. State width wanted. Shipping weight, 6 ounces.

9 P 2665.....79c

### COMPANION Machine Stand

An all-metal stand for your COMPANION 10-Inch Band Saw. Exceptionally strong and rigid. Has handy tool shelf and top measuring 10x21 inches. Height, 29 in. Shipping weight, 32 pounds.

99 PM 2719.....\$4.25

### COMPANION Tool Light

For mounting on your band saw. Clamps on handily. Extra large reflector throws the light on the work—keeps it out of your eyes. Complete with 15-in. flexible neck, reflector and cord and plug. Shpg. wt., 1 lb. 12 oz.

9 P 2264.....\$1.45

Easy Terms! ON ORDERS OF \$20 OR MORE SEE INSIDE FRONT COVER

Operates with surpassing smoothness and remarkable freedom from vibration. Controls are convenient—guards are husky and provide ample protection—the roomy table with its wood extension gives you an unusually large 15x10-inch working space. Use  $\frac{1}{3}$ -H.P. Motor 99 P 5607, shown on page 31. Complete with 48-inch "V" belt and 72-page instruction book. Shipping weight, 61 pounds.

99 PM 2302.....\$15.75

# CRAFTSMAN

REG. U. S. PAT. OFF

## 12-inch Ball Bearing Band Saw is Precision-Built Throughout

- SIX precision type ball bearings.
- Frame is made in one piece of extra heavy gray iron.
- Handles stock up to 6 inches in thickness.
- Safety type 12-inch rubber-faced wheels run on four sets of finest precision type ball bearings.
- Large 12½x12-inch table, with wood extension 18x12 in., gives ample capacity for work.
- Table tilts up to 45° angle with graduated scale showing exact angle.

**\$25<sup>95</sup>**

### SPECIFICATIONS

**Frame:** Heavy enough for a saw twice its size! Made in one piece! Close-grained gray iron throughout.

**Ball Bearing Wheels:** Both upper and lower wheel bearings are precision ball bearing type, two sets in each wheel. Practically noiseless. These wheels are of safety design. Dynamically balanced and run perfectly.

**Ball Bearing Saw Guides:** Another feature found only in higher priced saws. Both upper and lower guides have precision type ball thrust bearings and are fully adjustable. Properly adjusted, they keep the saw running true and smooth with minimum friction losses.

**Table:** Ground and polished, of heavy gray iron. Provided with large, rugged cradle upon which table tilts to any desired angle up to 45°. Large, easily read scale and pointer tell at a glance the angle to which table is set. Convenient locking handle gives quick, positive control. Wood extension at rear of table greatly increases working space to 18x12 inches.

**Dimensions:** Height, over all, 33½ in. Depth, front to rear, 22 in. Maximum width, 12 in.



## Smooth.. Silent.. Dependable Operation!

This powerful 12-inch band saw was designed for the craftsman who wants a saw that will cut with amazing ease and speed through wood up to 6 inches thick—that will operate smoothly and silently under all working conditions—and that has the vibrationless perfection afforded by high quality ball bearing wheels, precision manufacture and a rugged, extra-heavy frame. We've priced it lower than any comparable saw on the market. We believe it to be the biggest, most outstanding value today in the entire band saw field.

Exceptionally smooth in operation because of its ruggedness and well balanced wheels. The upper wheel is mounted on the highest quality steel spindle fitted with two precision type ball bearings. This spindle is carried on a heavy, fully adjustable turret with convenient controls for wheel alignment and blade tension. The lower wheel and each saw blade guide also is ball bearing equipped. Table with its soft metal center insert may be tilted to any desired angle up to 45°, and securely locked in position, the angle of tilt being indicated clearly on a large protractor scale. Complete with 48-inch belt, 2½-inch motor pulley and 72-page book of instructions. Shpg. wt., 104 lbs.

99 PM 2304.....\$25.95

**Easy Terms!** ON ORDERS OF \$20 OR MORE SEE INSIDE FRONT COVER

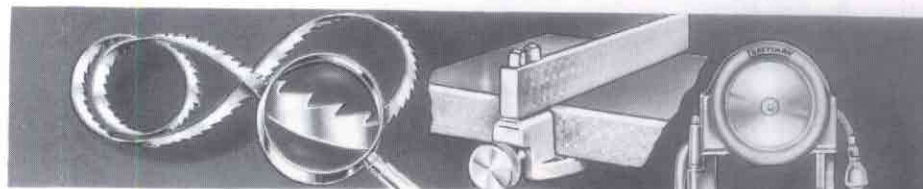

### COMPANION Band Saw Blades

For 99 PM 2304 12-Inch Band Saw. Made of finest quality of saw steel, carefully tempered and set. Tough yet flexible. Built by master saw makers. Shpg. wt., 8 ounces.

9 P 2657—Length, 77 inches. Furnished in widths of ½, ¾, 1¼, ¾ or 1½ inch. Specify width wanted..... 89c  
9 P 2668—77-Inch Metal Cutting Blade for use on non-ferrous metals such as aluminum, copper, etc. Shpg. wt., 7 ounces.... 89c

### Rip Fence

For use on above band saw. Useful in making straight cuts on thin pieces when used with blades ½-in. wide. Shpg. wt., 6 lbs. 99 P 2305.....\$2.25

### COMPANION Machine Stand

An all-metal stand for your CRAFTSMAN 12-Inch Band Saw. Top measures 10 in. x 21 in.; height, 29 in. Exceptionally strong and rigid. Shipping weight, 32 pounds. 99 PM 2719.....\$4.25

### COMPANION Tool Light

Clamp it on your band saw. Throws light on your work—extra large reflector keeps light out of your eyes. With 15-in. flexible neck, reflector and cord and plug. Shpg. wt., 1 lb. 12 oz. 9 P 2264.....\$1.45

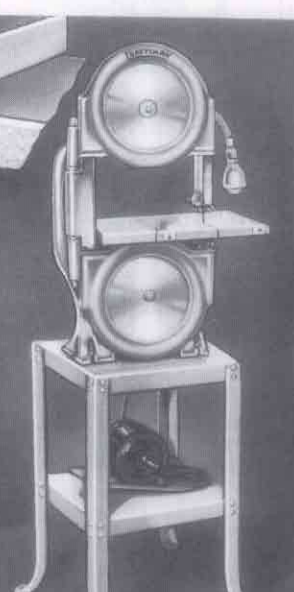

# CRAFTSMAN

REG. U. S. PAT. OFF.

## HEAVY DUTY SHAPER

Designed for the Expert  
It Is the Finest Tool of  
Its Kind!

- Ball bearing spindle is fully adjustable and reversible.
- Sturdy, well ribbed table, nicely machined. Size, 14x10 inches.
- Heavy gray iron sub-base and frame.
- Latest approved type guard.
- Dust chute directs chips away from operator.
- Adjustable motor bracket.
- Fence equipped with micrometer adjustment, insures accurate adjustment and permits shaper to be used as a jointer.

**\$14<sup>95</sup>**  
99 PM 2310

When we state that this heavy duty shaper is the finest tool of its kind we mean just that! None of the copies of this fine tool possess its sturdy accuracy or excellent design. The thousands sold attest to its popularity. The finest of precision-type ball bearings for mounting the spindle insures smooth operation. Spindle speeds of 8,000 to 10,000 R.P.M. give best results. Spindle accommodates cutters with 5/16 or 1/2-inch hole. A turn of the ball crank lever on the side of shaper raises or lowers spindle for obtaining various types of cuts. Solid one piece steel spindle fitted with special safety lock may be operated in either direction. Table has groove for miter gauge and round metal insert for use with large cutters or sanding drum. Spring hold downs. Laminated wood-faced fence is of most advanced type, rugged, accurate and fully adjustable. Use 1/2-H.P. motor, 99 P 5608. See page 31.

**99 PM 2312**—Heavy Duty Shaper, sub-base and motor bracket, without motor, but with motor pulley, adjustable fence, "V" belt, spring hold downs and 72-page fully illustrated book of instructions. Shipping weight, 60 pounds. **\$18.95**

**99 PM 2315**—Heavy Duty Shaper, complete with motor, sub-base, motor bracket, 72-page fully illustrated book of instructions, "V" belt, guard, guide and spring hold downs. See main illustration at top of page. Shipping weight, 92 pounds. **\$37.90**

**99 PM 2310**—Same as above but less motor, sub-base and motor bracket. Illustrated at left. Shipping weight, 47 pounds. **\$14.95**

**9 P 2465**—Extra cutter lock nuts for use with any of the above shapers. Also fit all standard 1/2-in. arbors and spindles. Shipping weight, 1 ounce. Each. **5c**

Easy Terms  
ON ORDERS OF  
100 OR MORE  
SEE INSIDE  
FRONT COVER

## Quality Cutters at Lowest Prices



9P2319 1/4-in. 69c  
9P2321 1/2-in. 69c  
9P2323 1 3/4-in. 89c  
9P2325 1 3/4-in. 89c  
9P2327 1 3/4-in. 89c  
9P2329 1 3/4-in. 89c  
9P2331 1 3/4-in. 89c  
9P2333 1 3/4-in. 89c  
9P2335 1 3/4-in. 89c  
9P2365—Tongue and groove. Shag. wt., 10 oz. \$1.75  
9P2367 98c  
9P2340 50c  
9P2342 50c  
9P2344 50c  
9P2350 50c  
9P2354 50c  
9P2356 50c  
9P2359 50c  
9P2362 50c  
9P2368 55c  
The top 2 rows of cutters are with the exception of 9P2340 and 9P2342 fit 1/2-in. spindle; all others fit 3/8-in. spindle. Shipping weight, collars and cutters, 6 ounces each.

**PROFESSIONAL FINISHES**  
Illustrating use of tongue and groove cutters 9P2365.  
Showing how 2 patterns may be obtained from 1 style of cutter.  
Pattern produced by a formed cutter.

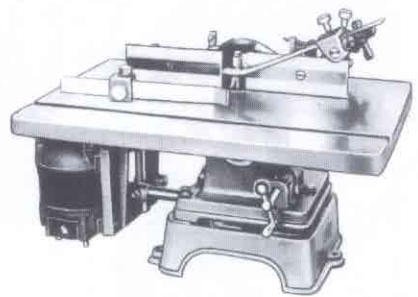

**99 PM 2313**—Shaper identical with 99 PM 2312 (listed at the right) except that it is fitted with large production type table, 15x21 in. Complete with sub-base, motor bracket, book of instructions, "V" belt, guard, guide and spring hold downs. Shipping weight, 67 lbs. **\$23.95**



At the left is a view showing shaper 99 P 2310, without motor, sub-base or motor bracket. An economical arrangement, particularly suited to lineshaft drive.

With sub-base and adjustable motor bracket as shown in main illustration, you have the best possible arrangement for direct drive.

### COMPANION MACHINE STAND

Mount your heavy duty shaper on this sturdy, all-metal stand. Extremely strong and rigid. Has 10x21-in. top. For full description see page 35. Shpg. wt., 32 lbs.

**99 P 2719..... \$4.25**

### COMPANION TOOL LIGHT

Clamps on shaper and gives you plenty of light right where you want it. Complete with 15-inch flexible neck, reflector, cord and plug. See page 34. Shipping weight, 1 pound 12 ounces.

**9 P 2264..... \$1.45**

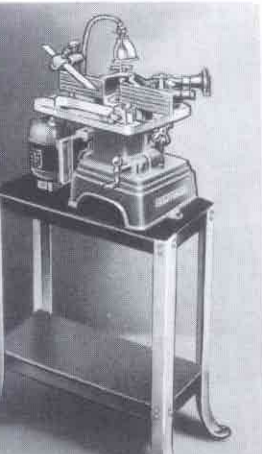

# COMPANION DRILL PRESS

- Ball thrust-bearing absorbs spindle thrust.
- Universal type semi-steel head.
- Auto-lubricated bronze spindle bearings.
- Extra sturdy base serves as auxiliary table.
- Unusually heavy, rigid table.
- "Feather-touch" clamp locks head to column.
- Quill is graduated full 3 inches in  $\frac{1}{16}$ -inch divisions.
- Quill provided with mortising collar. Uses standard attachments.
- Spindle provided with stop collar for drilling repetitive holes to same depth.

Sears are the largest distributors of power tools in the world. Even though it was supposedly impossible to produce a drill press of this type and quality we designed this drill and after months devised a way to produce it in large quantities and secure this phenomenally low price. It is made with great care and with many of the same materials as our larger and more expensive models. It may be used for shaping, mortising and routing as well as for drilling. Its seven speeds provide practically a universal range for metal or woodworking operations. The spindle is made from precision-ground steel and runs in auto-lubricated bronze bearings with a ball thrust bearing between spindle and quill. The quill is of high quality steel carefully ground, with accurately cut teeth for engagement with the steel feed pinion. Spindle unit is balanced by means of a spring with adjustable tension, providing ultra-sensitive feeding. Table is accurately milled and is slotted.

You can do rapid, accurate work with the COMPANION Drill Press. You will find it extremely well made. Can be supplied with idler assembly for lineshaft drive (see small illustration at right) at \$1.50 extra cost on original order. (Motor bracket type shipped unless otherwise specified.)

**99 PM 2372**—COMPANION Drill Press with "V" belt, 4-step motor pulley, 3-jaw chuck, without motor. Shipping weight, 70 pounds.....**\$13.50**

**99 PM 2373**—Same as above but with COMPANION  $\frac{1}{2}$ -H.P. ball bearing motor. Shipping weight, 102 lbs **\$23.50**

**99 P 2371**—Idler assembly only for lineshaft drive. With belt. Shipping weight, 6 pounds.....**\$3.25**

**Easy Terms!**  
ON ORDERS OF  
120 OR MORE  
-SEE INSIDE  
FRONT COVER



## SPECIFICATIONS

Over all height: 28 $\frac{1}{4}$  inches.

Over all width: 9 $\frac{1}{4}$  inches.

Over all depth with motor: 24 inches.

Maximum distance from table to chuck jaws: 7 $\frac{3}{4}$  inches.

Maximum distance from base to chuck jaws: 10 $\frac{3}{4}$  inches.

Spindle travel: 3 inches

Column diameter: 1 $\frac{1}{8}$  inches.

Drills to center of 12-inch circle.

Chuck capacity:  $\frac{1}{2}$  inch.

Table travel: 7 $\frac{3}{4}$  inches.

Range of speeds: 700, 1075, 1300, 1725, 2300, 2760 and 4000.

Size of table: 7 $\frac{1}{2}$ x7 $\frac{1}{2}$  inches.

Net weight: 65 pounds.

## Hollow Chisel Mortising

Cut mortises quickly with perfectly square ends or drill square holes by using this equipment. Shipping weight, 2 lbs. 8 oz.

**9 P 2461**—Mortising Chisel Housing.....**\$1.60**

**9 P 2451**—Collet Chuck for use with  $\frac{3}{8}$  and  $\frac{1}{2}$ -in. mortising bits. Shipping weight, 3 oz.....**60c**

Hollow chisels and bits for use with 9 P 2461 mortising attachment.

**9 P 2420**—Hollow Chisel. Sizes,  $\frac{1}{4}$  in.,  $\frac{3}{8}$  in., and  $\frac{1}{2}$ -in. State size. Shipping weight, 5 oz....**\$1.35**

**9 P 2422**—Mortising Bit. Sizes,  $\frac{1}{4}$  in.,  $\frac{3}{8}$  in.,  $\frac{1}{2}$  in. State size. Shipping weight, 3 oz....**\$1.19**

COMPANION Drill Press equipped with idler assembly.

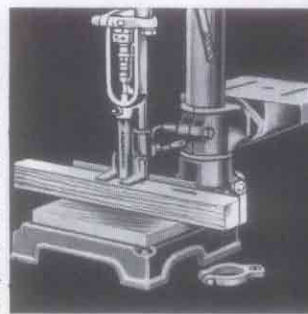

## Hold-Down Guide and Bracket

This accessory is indispensable in mortising, as it prevents the work from being lifted when chisel is raised. Adjustable guide insures straight line mortises. Shipping weight, 6 lbs. 8 oz.

**9 P 2457**—Hold-Down Guide and Bracket for Mortising.....**\$1.50**

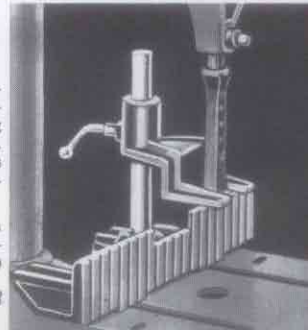

## CRAFTSMAN Twist Drills

Finest quality, American made twist drills. The product of master drill makers. Seven sizes in each set:  $\frac{5}{64}$ ,  $\frac{3}{32}$ ,  $\frac{1}{8}$ ,  $\frac{3}{16}$ ,  $\frac{1}{4}$ ,  $\frac{5}{16}$ , and  $\frac{3}{8}$  in. Shipping weight, 6 oz.

**9 P 6686**—Set of 7 High Speed Steel Twist Drills. Particularly recommended for use with drill presses and electric drills.....**\$1.49**

**9 P 6685**—Set of 7 High Carbon Steel Twist Drills.....**69c**

## COMPANION Drill Vice

Increase the range of work your drill will handle with this high quality vise. Priced at about one-third what is usually asked for similar quality vises. Strongly built. Complete with two extra jaws, one for round or irregular work and swivel block jaw for tapered pieces. Oxidized, non-rusting finish. Accurately cut screw with knurled end for fast action and bar for locking. Designed for the craftsman who handles a wide variety of work. Practically indispensable in handling tapered pieces and round objects such as pipe, rod, etc. Shipping weight, 5 pounds.

**9 P 2436**.....**\$1.98**

# CRAFTSMAN ALL-PURPOSE

REG. U. S. PAT. OFF.

## The Finest Ever Offered At This

When you purchase a drill press you should select one that is versatile—that may be used for a number of operations other than merely drilling. Naturally such work as routing, shaping, mortising and dovetail cutting demand a drill press of more than ordinary accuracy. You will find this accuracy in our CRAFTSMAN ALL-PURPOSE Drill Press—plus a rugged construction that enables it to stand up for years of trouble free service.

Spindle whip was formerly the cause of rough operation in drills even as crankshaft whip used to cause roughness in automobile engines. Many attempts have been made to correct this evil—none successful—until Sears removed the fundamental cause of the trouble and evolved this new type of drive. A truly basic improvement. Spindle whip is caused by belt pull being transmitted through the pulley assembly to the spindle. Sears, knowing this, developed a new drill drive . . . the pulley is mounted on a long steel sleeve accurately fitted into the drill head . . . entirely independent of the spindle it transmits none of the undesirable stresses to it. This method of construction produces the finest and smoothest running drill presses.

You will find illustrated below a number of accessories to widen the range of usefulness of your CRAFTSMAN Drill Press. Among these are routers—mortising routers, dovetail routers, router carving bits, etc.—cutters, spring hold downs, new type bronze bearing guide collars, etc. You can actually produce more than 50 different shapes of moulding edges with Sears high quality cutters, all carefully manufactured so as to make your drill more useful.

You will make no mistake in selecting the CRAFTSMAN Drill Press for your shop. We believe you will find it the most useful tool you own . . . inexpensive, versatile and a real favorite among power tools.

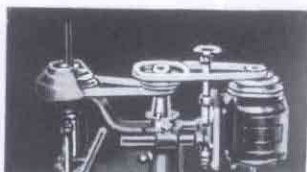

### Slow Speed Attachment

An exceptionally fine and useful attachment. Protected by patent. Lowest spindle speed, 200 R.P.M. Can be attached or removed in 3 minutes. Both belt tensions are adjustable by means of a built in cam action. Shipping weight, 4 pounds.

9 P 2396—Complete slow speed spindle drive and 2 Vee belts, ready to use. . . . \$3.95



### COMPANION Drill Vise

Increases the range of work your drill will handle. Strongly built. Oxidized, non-rusting finish. Accurately cut screw with knurled end for fast action and bar for locking. Complete with 2 extra jaws, for round or irregular work and swivel block jaw for tapered pieces. Shpg. wt., 5 lbs.

9 P 2436 . . . . . \$1.98

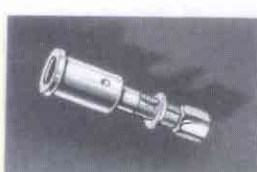

### Drill Press Adapter

For large size 1/2-inch bore shaper cutters shown and listed below. Inserted in knurled nut on drill spindle it is securely locked into place. Shipping weight, 7 ounces.

9 P 2435 . . . . . 79c

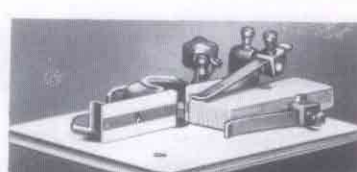

### Shaping Attachment

Large, finely finished plywood table, fitted with adjustable guard and guide. With hold down clips and fittings. Shpg. wt., 17 lbs.

9 P 2430—Complete attachment for drill press. . . . \$6.95  
 9 P 2428—Guard and guide only. Shipping weight, 4 pounds 12 ounces. . . \$2.35  
 9 P 2455—Spring clips only. Shipping weight, 3 pounds 14 ounces. . . \$1.50

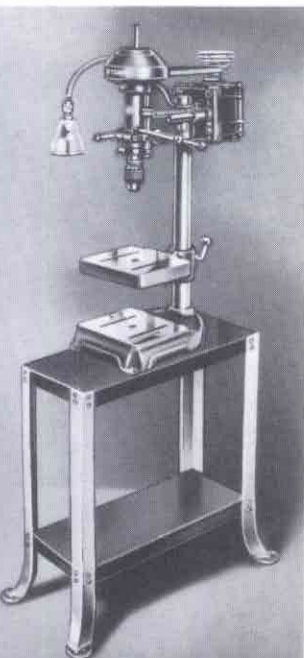

(A) 9 P 2404 3/8-in. Mortising Router. . . . 75c  
 (B) 9 P 2405 1-in. Mortising Router. . . . 85c  
 (C) 9 P 2403 1/2-in. Mortising Router. . . . 75c  
 (D) 9 P 2402 3/8-in. Mortising Router. . . . 59c  
 (E) 9 P 2400 1/4-inch Router. 50c  
 (F) 9 P 2401 1/2-inch Router. 50c  
 (G) 9 P 2409 1/4-in. Dovetail Router. . . . 50c



(A) 9 P 2410 1/4-inch Dovetail Router. 50c  
 (B) 9 P 2411 1/2-inch Dovetail Router. 59c  
 (C) 9 P 2416 3/8-inch Router Carving Bit. . . . 75c  
 (D) 9 P 2415 1/2-inch Router Carving Bit. . . 75c  
 (E) 9 P 2433 Adapter for small cutters. . . . 35c  
 (F) Set of 7 Twist Drills 9 P 6686 High Speed Steel. \$1.49  
 9 P 6685 High Carbon Steel. . . 69c  
 See page 13 for size, etc.  
 (G) 9 P 2323 1 3/4-inch Shaper Cutter. . . 89c

### COMPANION Machine Stand

Heavy all-metal stand for your COMPANION Drill Press. Top measures 10x21 in. Height, 29 in. Exceptionally strong and rigid. Has handy lower shelf for tools. Shipping weight, 32 pounds.

99 PM 2719 . . . . . \$4.25

### COMPANION Tool Light

Designed especially for power tool use. Fits handily on your Drill Press to throw the light exactly where you want it. Extra large reflector keeps light out of your eyes. Complete with 15-inch flexible neck, reflector and cord and plug. Shipping weight, 1 lb. 12 oz.

99 P 2264 . . . . . \$1.45

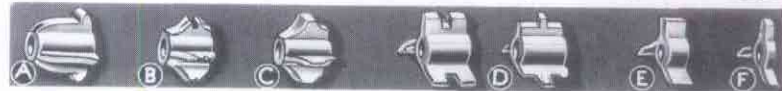

(A) 9 P 2325 1 3/4-inch Shaper Cutter. 89c  
 (B) 9 P 2327 1 3/4-inch Shaper Cutter. 89c  
 (C) 9 P 2329 1 3/4-inch Shaper Cutter. 89c  
 (D) 9 P 2365 Matched Set Tongue and Groove Cutters \$1.75  
 (E) 9 P 2321 1/2-inch Face Cutter. 69c  
 (F) 9 P 2319 1/4-inch Cutter. 69c



(A) 9 P 2331 Table and Rule Joint Bead Cutter. . . 89c  
 (B) 9 P 2335 Table and Rule Joint Cove Cutter. . . 89c  
 (C) 9 P 2333 Straight Face Cutter. 89c  
 (D) 9 P 2367 Guide Collars. 1/2-inch hole. 98c  
 (E) 9 P 2450 Collet Chuck for tapered spindles. 75c  
 (F) 9 P 2142 1/2-inch Jacobs Chuck for tapered spindle. Shpg. wt., 2 lbs. \$5.65

Shipping weight of all items above is 6 oz. unless otherwise specified.

# DRILL PRESS

## Low Price!

**Handles every type of Drill Press work, including shaping, mortising and dovetailing**

- Full floating spindle—belt pull is transmitted to head by means of large, deep-groove S.K.F. ball bearing.
- 5/8-in. spindle mounted in quill by means of two precision type ball bearings, absorbing all spindle thrust.
- Special guide construction eliminates rotational play in quill.
- Drills to center of a 13-inch circle.
- Smooth, uniform feeding assured by heavy ground steel quill with integral accurately cut teeth.
- Accurate indexed swivel table can be tilted to any angle.
- External depth gauge equipped with knurled lock nuts and is graduated in sixteenths of an inch.
- Base is machined to serve as auxiliary table.
- Equipped with genuine 1/2-in. Jacobs key chuck.

We designed this drill press for those who demand the utmost in utility at low cost. It is built throughout of the finest materials, with all parts accurately machined. From the tip of its 5/8-inch spindle to the carefully machined base it represents top-notch value. As a drill press it will drill holes from 1/16 to 1/2 in. The genuine Jacobs chuck supplied as standard equipment is the most accurate obtainable. Simply by reversing the head stock on the steel column and by mounting the table directly above it you can convert this press into an efficient spindle shaper. It may also be used for mortising, routing, sanding and dovetailing with equal facility.

*This is the first time any one has ever offered a drill press with full floating ball bearing spindle at this low price.* Three heavy duty deep groove S.K.F. ball bearings are used. The 4-step spindle pulley contains a large S.K.F. ball bearing which runs on a sleeve secured in the head. This construction insures a smooth, even flow of power from the motor to the spindle, and represents a real advance in securing smooth, accurate operation at all speeds. All spindle thrust is absorbed by two S.K.F. ball bearings which carry the spindle within the quill. This quill is made of solid steel, accurately ground. The teeth for receiving feed pinion are milled into it. A quickly adjustable stop gauge indicates at all times the depth of holes being drilled.

**99 PM 2384**—CRAFTSMAN Drill Press, less motor. Complete with 1/2-in. Jacobs chuck and key, endless "V" belt, and motor pulley. Shipping weight, 81 pounds. **\$23.50**

**99 PM 2385**—Same as above but with 1/4-H.P. ball bearing double shaft motor No. 99 P 5607. See page 31. Shpg. wt., 107 lbs. **\$33.50**

**Easy Terms!**  
ON ORDERS OF  
20 OR MORE  
-SEE INSIDE  
FRONT COVER



### SPECIFICATIONS

- |  |  |
|--|--|
| Over all height: 35 inches.                      | Table travel: 11 inches.               |
| Over all width: 10 3/4 inches.                   | Distance chuck to base: 15 1/2 inches. |
| Over all depth with motor: 24 inches.            | Steel column diameter: 1 7/8 inches.   |
| Maximum distance table to chuck jaws: 11 inches. | Number of speeds: 7.                   |
| Spindle travel: 3 inches.                        | Speed range: 600 to 4000.              |
|  | Table size: 8 by 9 inches.             |

#### Dovetailing Attachment

By using the attachment shown at the left you can cut dovetails that make perfect joints because you cut both members simultaneously. No special skill is required. Attachment consists of a steel comb, slotted to guide shank of router cutting to a pre-determined depth. End plates together with screw fittings for attaching the above guide or comb and clamps for holding work, and a 1/2-in. dovetail router are included in the outfit. Corners of pieces to be dovetailed are temporarily attached in clamp and held in proper position. Shipping weight, 4 pounds 1 ounce.

**9 P 2462**—Dovetail attachment set complete with router and instructions. **\$4.50**

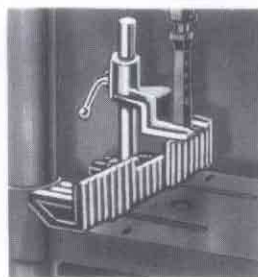
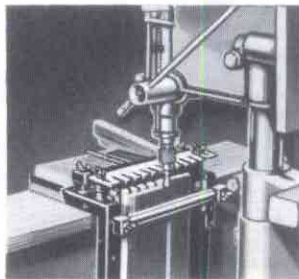

#### Hold-Down Guide and Bracket

Indispensable in mortising as it prevents the work from being lifted when chisel is raised. Can be used on 99 PM 2384 and 99 PM 2386 Drill Presses. Shpg. wt., 6 lbs. 6 oz.

**9 P 2457**—Hold-Down Guide and Bracket for Mortising. **\$1.50**

**9 P 6458**—Special Mounted Grinding Point for sharpening hollow mortising chisels. Shpg. wt., 3 oz. **40c**

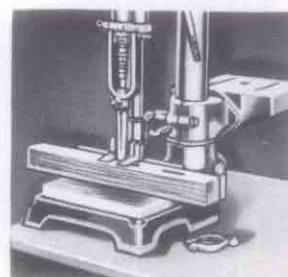

#### Hollow Chisel Mortising

Cut mortises quickly with perfectly square ends or drill square holes by using this equipment.

**9 P 2461**—Mortising Chisel Housing. For Drill Press. Shpg. wt., 4 lbs. **\$1.60**

**9 P 2450**—Collet chuck. Shpg. wt., 6 oz. **75c**

**9 P 2420**—Hollow Chisel for above. Sizes, 1/4 in., 3/8 in., and 1/2 in. State size. Shpg. wt., 5 oz. **\$1.35**

**9 P 2422**—Mortising Bit for above. Sizes, 1/4 in., 3/8 in., 1/2 in. State size. Shpg. wt., 3 oz. **\$1.19**

# CRAFTSMAN

REG. U. S. PAT. OFF.

# HEAVY DUTY With the Exclusive

## A DRILL PRESS EQUIPPED WITH FOUR SETS OF THE FINEST BALL BEARINGS

A drill that sets a new standard of quality, smooth operation, fine design and rugged construction. The drill that marks the dawning of a new era in fine drill press construction. The leader among finer tools.

For the man who wants only the very finest of power tools and is satisfied with nothing less than that . . . for the shop having a production problem that only a really high grade drill press will solve . . . we recommend the CRAFTSMAN High Quality Heavy Duty Drill Press.

A desire for quality, the highest quality. Something better than had ever been produced before was the motive force which prompted the design of this fine new CRAFTSMAN Drill Press.

Sears demanded a finer, more stable, more accurate, better balanced drill press than was available. It was therefore necessary for Sears engineers to design and develop such a drill press. An intensive study of drill press problems made it evident that none of the existing types of construction would relieve the major and fundamental troubles encountered in all current tools.

These investigations revealed the fact that the truly major difficulties encountered in all these drill presses could be traced to the undesirable forces imposed upon their spindles by belt pulls.

Lateral thrust from the motor and driving belt produces the bending moment or stress which is responsible for the various disagreeable vibrational characteristics inherent in all conventional drills. Therefore Sears mounted the driving pulley on a heavy tubular steel spindle which was supported on two sets of heavy duty deep row ball bearings in the drill head—entirely independent of the spindle. This unit absorbs all lateral thrust and transmits only a rotational force to the spindle. The spindle is also mounted in two sets of heavy duty deep row ball bearings within the quill as shown in the illustration on the page at the right. Be sure the drill you buy incorporates these fundamentally necessary features!

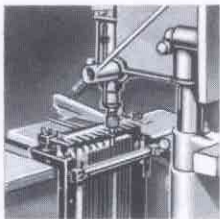

### Dovetailing

By using the attachment shown at the left you can cut dovetails that make perfect joints because you cut both members simultaneously. No special skill is required. Attachment consists of a steel comb, slotted to guide shank of router cutting to a pre-determined depth. End plates together with screw fittings for attaching the above guide or comb and clamps for holding work, and a 1/2-in. dovetail router are included in the outfit. Corners of pieces to be dovetailed are temporarily attached in clamp and held in proper position.

**9 P 2462**—Dovetail attachment set complete with router and instructions. Shipping weight, 4 lbs. 1 oz. . . . . \$4.50



### Shaping

You can convert your CRAFTSMAN Drill Press into a spindle shaper by inverting the head bracket and motor assembly, placing the new and improved extension table over it. This new type shaping attachment can also be used with the drill head in its normal position. For a more detailed illustration of guard and guide and for cutters of various shapes see page 12.

**9 P 2430**—Extension Table for spindle shaping with guard, guide and spring clips. Size, 14 1/2 in. x 18 in. Shipping weight, 17 pounds. . . . . \$6.95

**9 P 2435**—Shaping adapter for 1/2-in. bore cutters. Shipping weight, 7 ounces. . . . . 79c

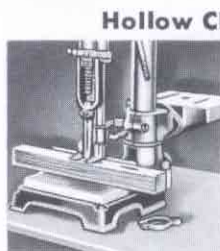

### Hollow Chisel Mortising

Accurate mortises are an essential in fine cabinet work and joinery. Cut mortises quickly with perfectly square ends or drill square holes by using equipment shown at left. Chisels and bits are of the very highest quality.

**9 P 2461**—Mortising chisel housing for Drill Presses. Shipping weight, 2 lbs. 8 oz. . . . . \$1.60

**9 P 2450**—Collet chuck. Shpg. wt., 6 oz. . . . . 75c

**9 P 2420**—Hollow chisels for use with 9 P 2461 attachment. Sizes 1/4, 3/8, and 1/2-inch. Specify size. Shipping weight, 5 oz. . . . . \$1.35

**9 P 6458**—Stone for sharpening above chisels. (Illustrated at bottom of page 18). Shipping weight, 3 oz. Each. . . . . 40c

**9 P 2422**—Mortising bit for use with above attachments. Sizes 1/4, 3/8, and 1/2-inch. Specify size. Shipping weight, 3 ounces. . . . . \$1.19

Accurate manufacture, fine balance of rotating parts, precision grinding of sliding parts such as the quill, etc., and careful assembly make this drill an especially fine tool. Produced by an old established manufacturer of highest quality precision equipment it represents a truly unusual value.

The spindle is provided with an accurate, easily read depth gauge graduated for the entire 4-inch feed range in 1/16-inch divisions. It also is provided with knurled stop nuts. A very efficient quill lock holds the quill securely for woodworking and carving operations. Table is carefully machined and may be tilted to any desired angle.

Seven speeds, from 600 to 5200 R.P.M. are available. Included in the regular equipment is a high quality 1/2-inch Jacobs chuck with key.

When you order a CRAFTSMAN Heavy Duty Drill Press you get the finest power tool that money can buy in the drill press field. Built for real service, correctly built in every detail. Order yours TODAY! Use 1/4-H.P. Motor 99 P 5607; see Page 31.

**99 PM 2386**—CRAFTSMAN Bench Model Drill Press, complete with motor pulley and belt, less motor. Shipping weight, 105 pounds. . . . . \$29.95

**99 PM 2388**—CRAFTSMAN Bench Model Drill Press, with motor pulley, belt and 1/4-H.P. 110-120 volt, 60 cycle A.C. motor. Shipping weight, 133 pounds. . . . . \$39.95

**9 P 2394**—Speed Reducer to convert the above drill press into a slow speed model. Shipping weight, 5 pounds. . . . . \$3.95

**Easy Terms on Orders of \$20.00 or more See Inside Front Cover**

### Hold-Down Guide and Bracket

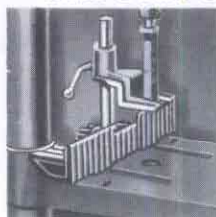

This accessory is indispensable in mortising, as it guides and prevents the work from being lifted when chisel is raised. For use on 99 PM 2386 and 99 PM 2384 Drill Presses.

Complete, ready for use. **9 P 2457**—Hold-down guide and bracket for mortising. Complete with necessary fittings for attaching to the drill press table. Shipping weight, 6 pounds 8 ounces. . . . . \$1.50

### COMPANION Machine Stand

An all metal stand for your CRAFTSMAN Drill Press. Top measures 10x21 in. Height, 29 in. Exceptionally strong and rigid. Handy lower shelf for tools. Shpg. wt., 33 lbs.

**99 P 2719**  
\$4.25

### COMPANION Tool Light

Designed especially for power tool use. Fits on your drill press to throw the light exactly where you want it. Complete with 15-in. flexible neck, extra large reflector, cord and plug. Shipping weight, 2 pounds.

**9 P 2264**  
\$1.45

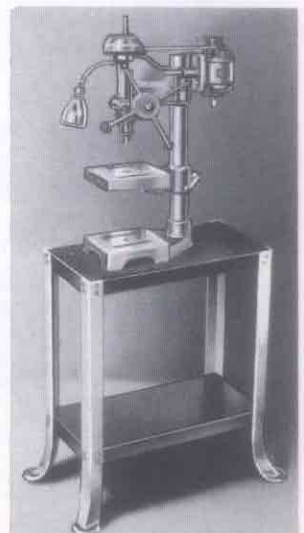

# DRILL PRESS "Floating Drive"

- Equipped with genuine 1/2-inch Jacobs key chuck.
- Spindle drive pulley is mounted on steel sleeve which rotates on two S. K. F. deep groove ball bearings mounted in head, eliminating all transverse belt pull on spindle.
- 5/8-inch special steel spindle mounted in quill on two sets precision type deep row heavy duty ball bearings.
- Heavy duty quill lock is of type used on most expensive machines; positive in action.
- Graduated depth gauge is milled flat and prevents rotational play in quill.
- New "Feather Touch" locking device secures head to column practically without effort.
- Table may be tilted to any desired angle.
- Longitudinal adjustment provided for between spindle and quill. Quality construction.
- Heavy steel tube column, 2 3/4-inch diameter, carefully machined.
- Table and base are slotted for securing mortising and shaping attachments, jigs, fixtures, etc.

## SPECIFICATIONS

Over all height: 40 in.  
Over all width: 11 3/4 in.  
Over all depth: 24 in.  
Maximum distance from table to chuck jaws: 13 in.  
Maximum distance base to chuck jaws: 19 in.  
Spindle travel: 4 in.  
Diameter of column: 2 3/4 in.  
Chuck: 1/2-1/2-in. Jacobs.  
Table travel: 13 in.  
Number of S.K.F. heavy duty ball bearings: 4.  
Number of speeds: 7  
Range of speeds: 600 to 5200 R.P.M.  
Table size: 10x10 in.  
Drills to center of 15-inch circle.

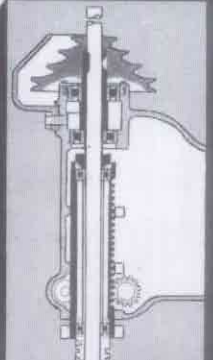

## CRAFTSMAN HEAVY DUTY FLOOR TYPE DRILL PRESS

We are furnishing our CRAFTSMAN Heavy Duty Drill Press in floor type for use where available bench space is limited. In every detail it is of the same high quality as our 99 PM 2386 Bench Type. The sturdy base is designed not only to act as a foundation for the drill but is also finished, slotted and may be used as a drill table. Use 1/2-H. P. motor 99 P 5607. See Page 31.

### SPECIFICATIONS

Over all height: 70 in.  
Over all width: 18 in.  
Over all depth: 30 in.  
Maximum distance from table to chuck jaws: 41 in.  
Maximum distance from base to chuck jaws: 47 in.  
Table travel: 41 in.

All other specifications are identical with 99 PM 2386.

#### 99 PM 2391

CRAFTSMAN Floor Model Drill Press, less motor. Shpg. wt., 160 lbs. . . . . \$34.50

99 PM 2393—Same as above but with COMPANION 1/2-H.P. Ball Bearing 110-120 volt, 60 cycle A.C. motor. Shipping weight, 188 pounds. . . . . \$44.50

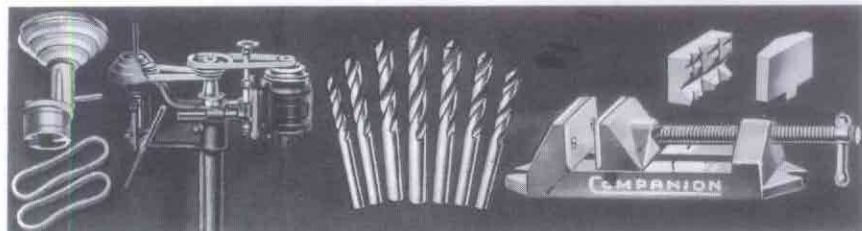

### Slow Speed Attachment

A very handy attachment. Mounts in the top of drill press column and serves as a countershaft, providing a minimum speed of 200 R.P.M. converting the CRAFTSMAN Heavy Duty Drill into a slow speed type. Can produce even lower speeds than the slow speed drills. Permits greater range of operations as drill may be used for either high or low speed. Shpg. wt., 5 lbs.  
9 P 2394 . . . . . \$3.95

### CRAFTSMAN Twist Drills

Finest quality, American made twist drills. The product of master drill makers. Seven sizes in each set: 3/64, 1/32, 1/16, 3/32, 1/8, 5/32, 3/16, 1/4 and 1/2 in. Shipping weight, 5 ounces.  
9 P 6686—Set of 7 High Speed Steel Twist Drills. Particularly recommended for use with drill presses and electric drills. . . . . \$1.49  
9 P 6685—Set of 7 High Carbon Steel Twist Drills. . . . . 69c

### COMPANION Drill Vise

Increases the range of work your drill will handle. Strongly built. Oxidized, non-rusting finish. Accurately cut screw with knurled end for fast action and bar for locking. Complete with 2 extra jaws for round or irregular work and swivel block jaw for tapered pieces. Particularly valuable when drilling small pieces which are hard to hold. Also very useful in holding odd shaped pieces in the proper position for drilling.  
Shpg. wt., 5 pounds.  
9 P 2436 . . . . . \$1.98

Easy Terms ON ORDERS OF \$20 OR MORE SEE INSIDE FRONT COVER

# The Tool of a

# CRAFTSMAN

REG. U. S. PAT. OFF.

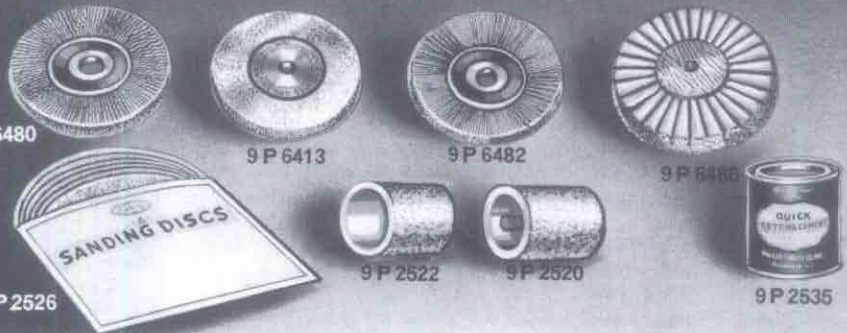
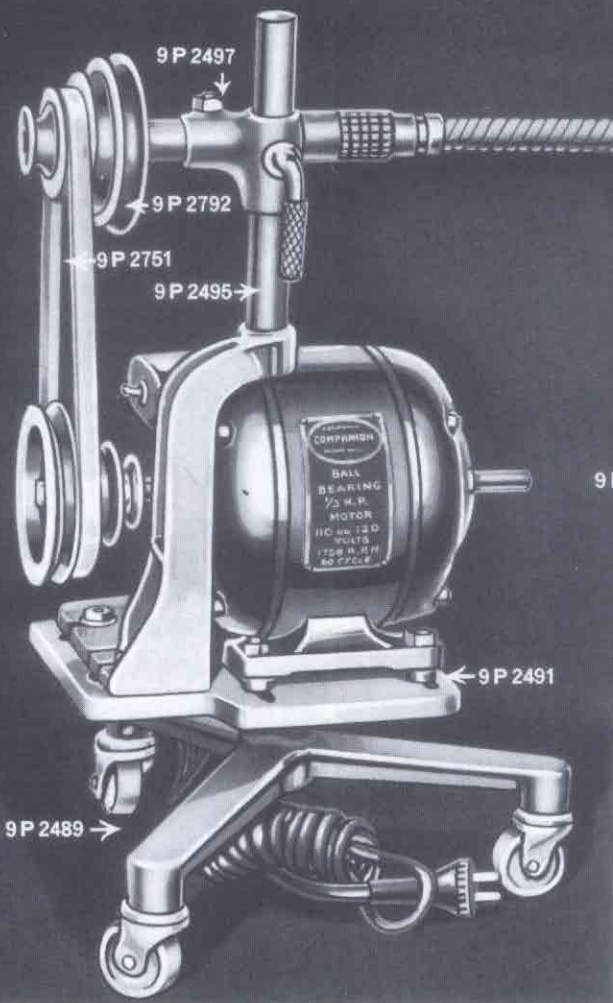

## STANDARD SPEED SHA

- Soft steel grease-tight casing with solid brass ferrule at each end. Plated and rustproof.
- Selected high tensile steel wire core, wound in alternate layers to form strong, compact, yet flexible, drive of many layers.
- Steel ends of core casing and securely swaged together.
- Casing fitted with ball bearings for sure easy operation.
- Adapter provided for use with accessories having standard shafts.
- Wide range of speeds.

## High Speed Shaft Outfits

Highest quality throughout. The handpiece is fitted with two sets high quality ball bearings. Motor is a powerful, specially designed 17,000 r.p.m. 110-volt Universal type (A.C. or D.C.) and is provided with hinged bracket for suspending motor from any convenient hook. 50-inch flexible shaft is fitted with steel supports at ends. The casing is leakproof and covered with neat black impregnated cord cover. Standard accessories may be attached to the handpiece. An ideal outfit for high speed carving, grinding, etc.

**9P 2635**—Complete High Speed Shaft; core, casing motor coupling, heavy duty ball bearing hand piece and 17,000 R.P.M. ball bearing motor. Shipping weight, 12 pounds. **\$24.25**

**9P 2634**—High Speed Flexible Shaft Outfit, as above, but less motor. Shipping wt., 5 lbs. **\$9.25**

**9P 2642**—High Speed Motor only. Shipping weight, 10 pounds. **\$14.95**

**9P 2643**—High Speed Motor Coupling only. Shipping weight, 1 lb. 8 oz. **\$1.50**

**9P 2640**—High speed collet chuck for use with flexible shaft. Supplied in 3 sizes to fit 1/8, 1/4 or 3/8 inch tool shanks. Specify size. Shpg. wt., 6 oz. Each. **75c**

### Portable High Speed Flexible Shaft

The high speed flexible shaft can also be made up for shop use as shown at the left.

- |                                 |                             |
|---------------------------------|-----------------------------|
| <b>9P 2489</b> —Base            | <b>9P 2491</b> —Table       |
| <b>9P 2495</b> —Support         | <b>9P 2751</b> —Belt        |
| <b>9P 2465</b> —Headstock       | <b>9P 2792</b> —Pulleys (2) |
| <b>9P 2637</b> —Handpiece       | <b>9P 2638</b> —Casing      |
| <b>9P 2639</b> —Core            | <b>9P 2640</b> —Chuck       |
| <b>9P 5608</b> —Motor (page 31) |                             |

Other combinations can be made up to meet individual needs of the shop or job.

**9P 2638**—Extra High Speed Casing. Shipping weight, 1 pound 4 ounces. **\$3.50**

**9P 2639**—Extra High Speed Core. Shipping weight, 1 pound. **\$1.50**

### Carving Cutters for High Speed Router

Accurately made high speed cutters of finest quality tool steel. For use on High Speed Router Attachment for CRAFTSMAN 24 inch Jig Saw.

**9P 2644**—Specify item wanted. Shipping weight, each, 4 ounces.



On this page you will find described and illustrated the finest flexible shaft outfits ever built for anywhere near this price. No other tool ever made provides so much flexibility, speed, economy and convenience. Thousands of these outfits are in daily use for grinding, polishing, buffing, sanding, refinishing, paint removal, etc. Because of their great portability you can take these outfits right to the job. They roll easily on the ball bearing caster base. For use in the shop, the garage, the home, they have no equal. With these outfits you can perform a large number of diversified operations with ease and facility. Once you own one of these Flexible Shaft Outfits you will wonder how you were able to get along without it!

Every part of this outfit is built for service. No detail is skimmed . . .

## EXTRA ATTACHMENTS MAY BE

	Shpg. Wt.	Price		Shpg. Wt.	Price
<b>9P 2489</b> —Base with Casters	4 lbs. 8 oz.	<b>\$1.10</b>	<b>9P 2522</b> —Sanding Belts for Drum, Fine, medium or coarse. State choice	1 lb.	.85
<b>9P 2491</b> —Table for Portable Outfit	5 lbs. 14 oz.	.85	<b>9P 2239</b> —6-in. Sanding Disc with Rubber	4 lbs. 8 oz.	.85
<b>9P 2495</b> —Support for Jack Shaft	4 lbs. 8 oz.	.85	<b>9P 2526</b> —Pkg. of 6 Sanding Discs, 6-in.	1 lb. 7 oz.	1.10
<b>9P 2497</b> —Head Stock	1 lb. 7 oz.	1.10	<b>9P 2535</b> —1/2 Pt. Can Cement	1 lb. 8 oz.	1.10
<b>9P 2500</b> —Ball Bearing Hand Piece	1 lb. 8 oz.	1.10	<b>9P 2792</b> —4-inch Four Step V Pulley	1 lb. 10 oz.	1.10
<b>9P 2505</b> —Casing, 43-inch	2 lbs. 12 oz.	1.10	<b>9P 2751</b> —Endless V Belt, 74-inch	1 lb.	1.10
<b>9P 2510</b> —Core, 43-inch	1 lb.	1.10	<b>9P 2531</b> —Sheepskin Polishing Pad	10 oz.	.25
<b>9P 2515</b> —Grip for Shaft	1 lb. 10 oz.	.25	<b>9P 6490</b> —6-inch Cloth Buffer	5 oz.	.25
<b>9P 2517</b> —Grinding Wheel Guard	1 lb. 6 oz.	.25	<b>9P 2537</b> —Lubricant, per tube	5 oz.	.23
<b>9P 2130</b> —Drill Chuck, 3/4-inch	5 oz.	.23	<b>9P 6413</b> —4x1/2-inch Grinding Wheel	4 oz.	.50
<b>9P 6484</b> —Carbon Removing Brush	4 oz.	.50	<b>9P 6480</b> —4-inch Coarse Grinding Wheel	1 lb. 2 oz.	.98
<b>9P 2520</b> —Sanding Drum with 2 Belts and Adapter	1 lb. 2 oz.	.98	<b>9P 6482</b> —4-inch Fine Wire Wheel		

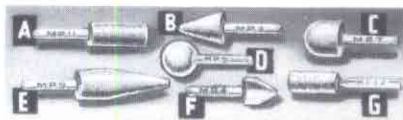

Grind Stones

- |                              |                               |
|------------------------------|-------------------------------|
| <b>3/8-inch shanks</b>       | (D) <b>9P 6459</b> —MP5. 45c  |
| (A) <b>9P 6462</b> —MP11 45c | (E) <b>9P 6461</b> —MP9. 50c  |
| (B) <b>9P 6457</b> —MP3 45c  | (F) <b>9P 6458</b> —MP4. 40c  |
| (C) <b>9P 6460</b> —MP7 45c  | (G) <b>9P 6463</b> —MP12. 45c |
- Shipping weight, each, 3 oz.



**9P 2546**—Ball Bearing Motor Coupling for attaching Standard Speed Flexible Shaft directly to motor. Equipped with high quality ball bearings. Shipping weight, 11 oz. **\$1.10**

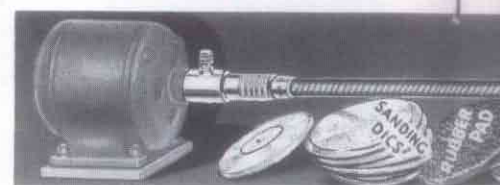

### The Handiest Motor

One of the handiest tools in your shop. Has core of selected high tensile steel wire wound in alternate layers. The motor coupling is fitted with ball bearings. Included are 1/2-inch three-jaw chuck, chuck adapter and improved motor coupling, sanding disc wheel, package of assorted sanding discs, graphite lubricant, sheepskin polishing pad, 6-inch cloth buffer, 4x1/2-inch grinding wheel, flexible shaft casing and core, hand

# Thousand Uses

## FLEXIBLE SHAFT OUTFIT

Complete 9 P 2505 →  
**\$18<sup>95</sup>**  
 Less Motor ← 9 P 2500



## FAST and ACCESSORIES

carefully machined  
 on.  
 ball bearings to in-  
 long life.  
 to accommodate  
 standard 1/2-in. hole.  
 needs.

- Hand piece spindle runs on two sets of ball bearings.
- Every outfit rigidly inspected before shipment to insure perfect running of every moving part.
- Mounted on ball bearing caster base to provide utmost portability.

no corners are cut . . . the quality is kept at Sears high standard down to the smallest part or accessory. The reason you can buy a Flexible Shaft Outfit from Sears for about HALF what others ask for similar quality is that we sell more outfits than any other distributor in the land. Our huge volume enables us to cut buying, shipping and handling costs. As a result you are sure of BIGGEST SAVINGS when you buy your outfit from Sears, PLUS the highest quality.

- 99 P 2475—Flexible Shaft Outfit shown above, with 7 1/2-ft. flexible shaft and accessories, but without motor. Shipping weight, 40 pounds. . . . . \$18.95
- 99 PM 2476—Flexible Shaft Outfit as above, complete with COMPANION 1/4-H.P. ball bearing motor. Shipping weight, 66 pounds. . . . . \$28.95

ON ORDERS OF  
 \$20 OR MORE  
 SEE INSIDE  
 FRONT COVER

## HEAVY DUTY Portable Shaft Outfit

One of the finest Heavy Duty Flexible Shaft Outfits ever designed for the garage, auto repairman, machine shop or wherever an exceptionally sturdy tool is required. Heavy 66-in. shaft is made with rubber covered steel casing that is permanently grease tight. High tensile steel wire core is 3/8 in. in diameter. Motor and jack shaft are supported by husky steel yoke which locks in any position instantly. Height is adjustable to suit work. Equipped with 1/4-H.P. COMPANION ball bearing 110-120-volt A.C. motor having speed of 3450 R.P.M. The step cone pulleys and adjustable headstock provide a wide range of speeds. Hand piece spindle revolves on high grade Timken bearings. In every detail a quality outfit that will handle heavy work with ease. Shipping weight, 165 lbs.



- 99 PM 2633—Heavy Duty Flexible Shaft Outfit, complete with ball bearing motor and 1/4-H.P. motor. Shipping weight, 165 lbs. . . . . \$58.95
- 99 PM 2632—Same as above, but without motor. Shipping weight, 130 pounds. . . . . \$41.00

## BE PURCHASED SEPARATELY

	Shpg. Wt.	Price		Shpg. Wt.	Price
um. Fine, medi-	2 oz.	10c	9 P 6487—Floor Waxing Brush, 6-inch. . . . .	11 oz.	49c
with Rubber Pad.	4 oz.	15c	9 P 2543—Drill Chuck Adapter. . . . .	6 oz.	30c
Discs, 6-inch . . . . .	5 oz.	20c	9 P 2533—Sheepskin Polishing Drum. . . . .	3 oz.	45c
Pulley . . . . .	2 oz.	10c	9 P 6485—2 3/4-inch Wire Cup Brush. . . . .	4 oz.	49c
inch . . . . .	10 oz.	50c	9 P 6486—6-inch Tampico Brush. . . . .	8 oz.	49c
Pad. . . . .	3 oz.	15c			
Wheel . . . . .	4 oz.	20c	9 P 2645—Ball Bearing Headstock similar to No. 9 P 2497 except		
Wheel . . . . .	3 oz.	15c	fit with heavy duty high speed ball bearings. For use with Standard		
Wheel . . . . .	7 oz.	35c	and High Speed Shafts. Shipping weight, 2 lbs. 12 oz. . . . .		\$4.95
Wheel . . . . .	1 lb.	45c	9 P 2637—Heavy Duty High Speed Ball Bearing Hand Piece, much		
Wheel . . . . .	7 oz.	35c	heavier than No. 9 P 2500 for use with both Standard and High		
Wheel . . . . .	5 oz.	25c	Speed Shafts. Shipping weight, 1 lb. 8 oz. . . . .		\$2.95

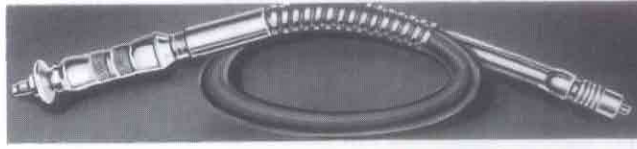

### Heavy Duty Flexible Shaft

Heavy duty shaft only for attachment direct to any 1/2-inch motor shaft. Fitted with Timken bearing hand piece and work arbor at one end and motor coupling at the other. Shipping weight, 9 pounds. . . . . \$14.95

9 P 2631

### Low Priced Portable Unit

The heavy duty Flexible Shaft Outfit can also be made up in an economical unit as shown at the right from parts listed on this page. Motors on page 31.

- 9 P 2489—Base
- 9 P 2491—Table
- 9 P 2631—Flex. Shaft
- 9 P 5608—Motor



The heavy duty or standard speed flexible shafts should never be operated at speeds less than 1750 R.P.M. High speed shafts should be operated over 5000 R.P.M.

### Best Motor Attachment Of All

grip ball bearing handpiece, and rubber pad. Length, over all, 50 in. To double the length an extra core No. 9 P 2510 and casing 9 P 2505 may be added. Outfit does not include motor. Shipping weight, 8 pounds 12 ounces. . . . . \$6.95

9 P 2630—Complete Outfit as illustrated. . . . . \$6.95

9 P 2629—Outfit except accessories shown below shaft. Shipping weight, 4 lbs. 12 oz. . . . . \$4.95

Additional accessories listed above.



### Ball Bearing Angle Head

For use with either standard speed or heavy duty flexible shafts for sanding, buffing, polishing, etc. Equipped with 3 to 2 reduction gear and convenient handle for holding. Accurately cut and carefully hardened steel gears run in grease tight housing. A real value at this price! Shpg. wt., 3 lbs. 8 oz. . . . . \$14.95

9 P 2646 . . . . . \$14.95

# CRAFTSMAN

REG. U. S. PAT. OFF.

## BELT and DISC SANDER The Finest Tool of Its Kind!

- Disc sanding table is universally adjustable.
- Beautifully finished frame of semi-steel.
- Oversize auto-lubricated bronze bearings.
- Disc sander finishes concave portions of work which cannot be reached by belt sander alone.
- Belt sander mounts horizontally or vertically, as desired.
- Disc sander table tilts to any angle up to 45°.
- Quick acting belt adjustments are sturdy and accurate.



**\$12<sup>95</sup>**

## Amazing Quality at this Price

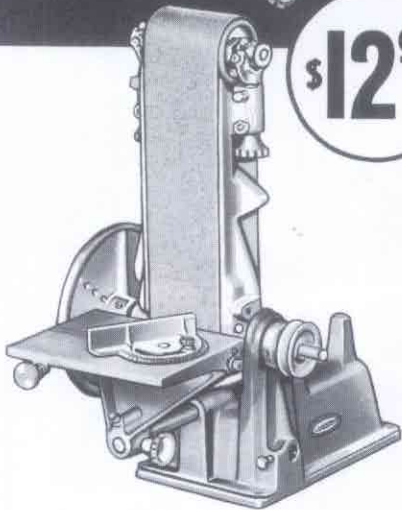

Sander belt in vertical position with sanding table mounted at end of machine for use as vertical sander. The 8-inch sanding disc and table may be used either on right or left of belt sander. This feature permits this sander to be mounted on the end of your bench that is most convenient.



**CRAFTSMAN Machine Stand**  
This all-metal machine stand has 10x21-in. top for mounting your combination disc and belt sander. 31 inches high. Exceptionally strong and rigid. Full description on page 35. Shpg. wt. 33 lbs. 99 P 2719.....\$4.25

**CRAFTSMAN Tool Light**  
Extra large reflector throws light on your work, not in your eyes. Has 15-in. flexible neck, reflector and cord and plug. See page 34. Shpg. wt., 2 lbs. 9 P 2264.....\$1.45



### Abrasive Discs and Belts

Package of 6 assorted fine, medium and coarse sanding discs. Shipping weight, 9 ounces.  
9 P 2216—For use on Wood.....35c  
9 P 2217—For use on Metal.....39c  
Abrasive belts for CRAFTSMAN Sander. State grit desired, fine, medium or coarse. Shpg. wt., 4 oz. each.  
9 P 2218—For use on Wood, each.....29c  
9 P 2215—For use on Metal, each.....39c

One of the most versatile tools in Sears big Power Tool line! The disc sander table is adjustable as to angle, enabling you to do extremely accurate sanding of mitered edges. The sanding table also is adjustable as to position, and may be used on either right or left side of sander, or at end of machine. It may be tilted to any desired angle and securely locked in position. Belt sander can be used horizontally or vertically or at any intermediate angle. Extra long bronze bearings on the main arbor insure long life and smooth operation. All spindle bearings are of the auto-lubricated type which effectively prevents abrasive material from damaging the spindles. We cannot emphasize too strongly the extremely high quality of this tool. Note the expensive universal bearing mechanism provided for adjustment of front roller, provided with positive locks and steel bearing seals. Such design insures you without question the most for your money. We designed it to do the work of machines selling for much higher prices. It has ample capacity for the small shop or craftsman. We recommend 1/4-H.P. motor 99PM 5607, shown on page 31. Recommended operating speeds: 1200 to 1600 R.P.M. Only those who own this new type sander know its great utility. It performs a great variety of laborious hand operations with ease. Its price and quality cannot be matched! Complete with 8-inch abrasive disc, 4-inch sanding belt and instructions. Shipping weight, 42 pounds.

99 PM 2213.....\$12.95

Easy Terms! ON ORDERS OF \$20 OR MORE SEE INSIDE FRONT COVER

# COMPANION

## 4-Inch JOINTER-PLANER An Exceptionally Fine Tool

- Sturdy gray iron frame is unusually rigid, accurately machined and finished.
- Fitted with large, high quality bronze bearings.
- Finely balanced cutter head is accurately made and fitted with 3 high speed steel blades.
- Front and rear tables are adjustable and move on accurate and well machined ways.
- The sturdy, accurate fence is fitted with angular scale having large, easily read figures.
- Equipped with safety type guard which need not be removed even for rabbeting.

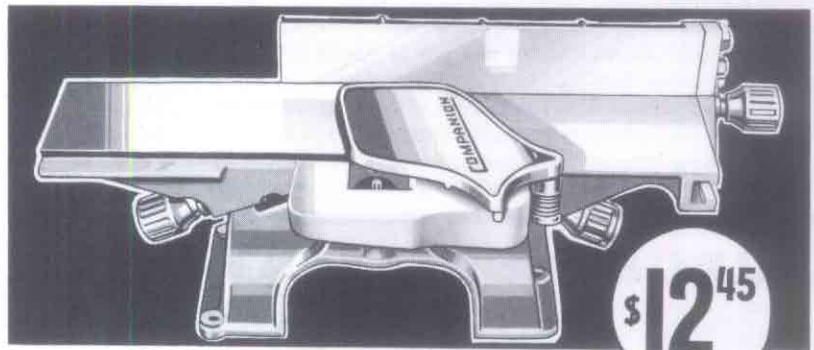

**\$12<sup>45</sup>**

Accurately machined tables...  
New type safety guard...  
High speed steel knives.

Ruggedly built with a well designed, substantial base and tables; will last for years. The cutter head is finely balanced, mounted on a high quality steel shaft running on the finest bronze bearings insuring smooth, easy operation even under the heaviest cuts. This tool has a nation-wide reputation for its smooth, easy operation. The tables are large and carefully designed to retain their accuracy. Large, carefully machined ways insure accuracy and parallelism of the tables for all depths of cut. The guard need never be removed even for rabbeting as it may be lowered and swung under the rabbeting ledge ready for instant return to its normal position as soon as the rabbeting operation is finished. For all normal service the cutter head is covered either by the material being cut or by the safety type quick return automatic guard. The jointer fence is fitted with large, easily read graduations which enable the operator to quickly read the angular setting of the fence. The high speed steel knives in the cutter head retain their sharpness and free, easy cutting qualities much longer than ordinary knives. Both tables are fully adjustable. Shipping weight, 36 pounds.  
99 P 2284.....\$12.45

**4-Inch Jointer-Planer Knives**  
Made of high speed tool steel. Take and hold a keen edge. Set of three for COMPANION jointer-planer. Shpg. wt., 8 oz. 9 P 2289.....\$1.95

**COMPANION Tool Light**  
Extra large reflector keeps light out of your eyes but gives you plenty where you want it. Complete with 15-in. neck, reflector and cord and plug. Shpg. wt., 2 lbs. 9 P 2264.....\$1.45

**COMPANION Machine Stand**  
Mount your jointer-planer on this all-metal stand. Has 10-in. x 21-in. top and is 31 in. high. Very strong and rigid. Shpg. wt., 33 lbs. 99 P 2719.....\$4.25

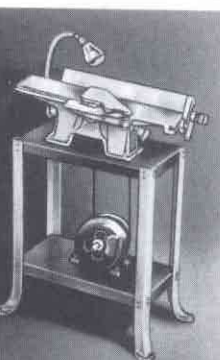

Easy Terms! ON ORDERS OF \$20 OR MORE SEE INSIDE FRONT COVER

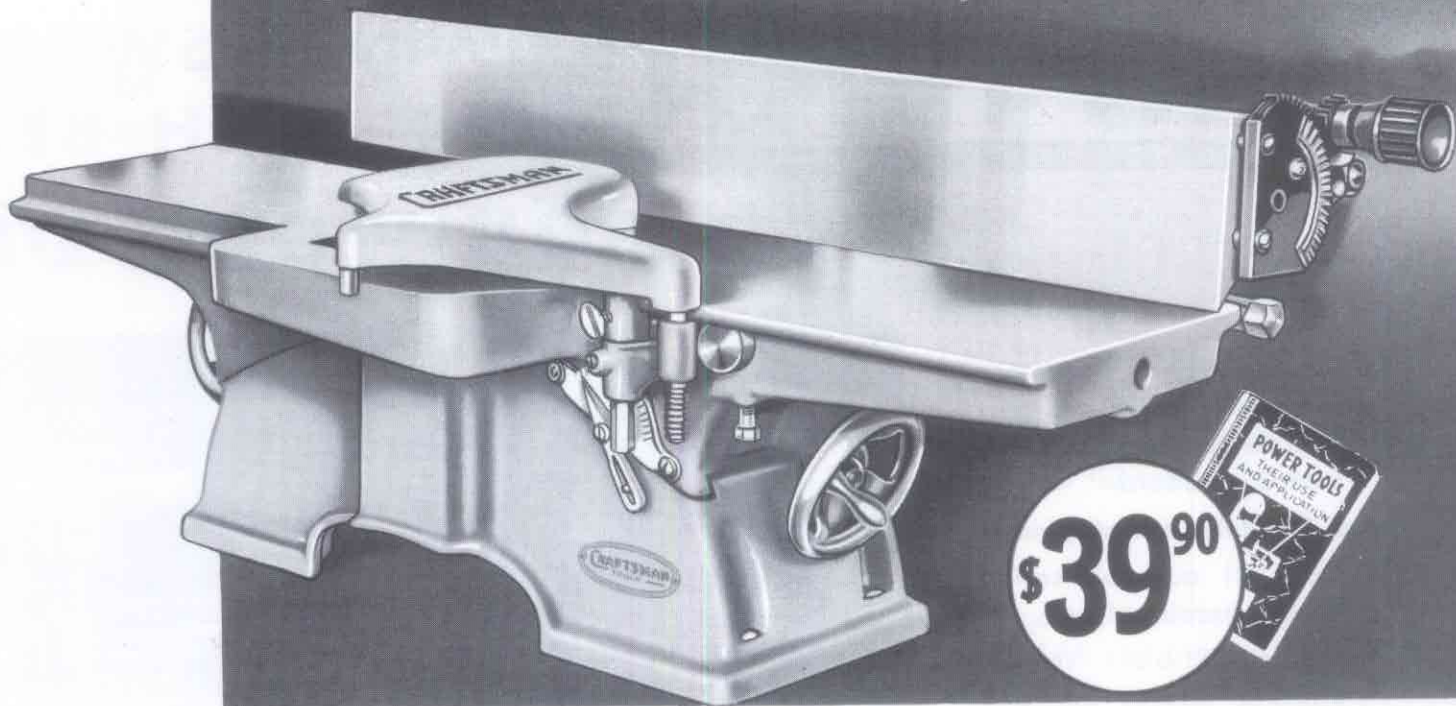

# CRAFTSMAN

REG. U. S. PAT. OFF.

## 6-INCH HEAVY DUTY JOINTER-PLANER

Unfailing accuracy . . . heavy duty precision type ball bearings

### SPECIFICATIONS

**TABLES:** Heavy cored castings, accurately ground; oversize, accurately milled dovetail ways for tables insure permanent accuracy. Adjustable gibs. Dimensions: Front table, 17½ inches long; rear table, 15½ inches long. Width, 7¾ inches.

**BEARINGS:** Finest quality heavy duty S.K.F. ball bearings enclosed in dust-proof housings, insure unvarying accuracy and long life.

**CUTTER HEAD:** Made of solid steel, 6 inches long, 2½ inches in diameter, with knife slots ground in the shape of inverted wedges, assures accurate and positive locking of knives.

**BASE:** Heavy gray iron, strongly ribbed with finely milled dovetail ways and adjustable gibs.

**FENCE:** Full 28 inches long, 4 inches high. Made of fine quality gray iron, precision ground. May be tilted either way by means of geared mechanism, the degree of tilt being clearly indicated on quadrant. An outstanding feature of this fence is that it may be moved as a unit across the table.

**GUARD:** Ingeniously designed and quick acting. Provides full protection to the operator. It recedes from its closed position as work is fed to the cutter, the knives thus being covered either by the guard or by the work at all times. May be dropped to one side of front table for rabbeting. Never need be removed from tool.

**OPERATING SPEED:** 4500 R.P.M.

**DIMENSIONS:** Length, over all, 37 in. Height, over all, 13 in. Width, over all, 13 in. Rabbeting capacity up to ¾ inch depth of cut.

**PROTRACTOR DEPTH GAUGE:** Indicates position of front table at all times. The movement of table is magnified by pointer, thus insuring closest accuracy.

We believe this high speed, heavy duty jointer furnishes the expert craftsman the finest and most accurate power tool of its kind that money can buy. The true-running cutter head is mounted on ¾-inch steel shaft, running in heavy precision type S.K.F. ball bearings that are enclosed in dust-proof housings. Accuracy is also insured by the carefully ground tables which slide on dovetail ways, this movement is controlled by conveniently located hand wheels. Tables may be locked in any position by a positive mechanism which operates so as to pull the tables into the ways, guaranteeing the very greatest accuracy. The cutter head is solid steel with knife slots of special wedge shape to insure permanence in locking action. Of special interest to the expert craftsman is the precision ground gray iron fence whose angle of tilt is easily controlled by a heavy geared mechanism operated by a hand wheel. This heavy geared mechanism assures utmost rigidity and accuracy in all positions. The entire fence and tilting mechanism may be moved laterally across the table without affecting the angular setting. The entire tool is made extra-heavy to insure smooth operation and accuracy. Complete protection is furnished the operator by a cast aluminum guard of the automatic type, which keeps knives covered either with guard or work. If you want the very utmost in accuracy and dependability in a heavy duty jointer for your shop, this is the one to buy. Motor required, ½ to ½-H.P. See pages 30 and 31.

Complete with geared fence, high speed steel knives, pulley, motor pulley, belt and 72-page instruction book.

Shipping weight, 160 pounds.

99 PM 2288 . . . . . \$39.90

- Heavy gray iron frame. Accurately milled, ground, faced and polished. Extra large base.
- Solid steel cutter head, 2½ inches in diameter.
- Heavy duty S. K. F. ball bearings enclosed in dust-proof housings. Will give lifetime service.
- Full 5/8 inch diameter steel shaft. Accurately machined. Fitted with balanced pulley.
- Both tables adjustable. Positive locks. Maximum depth of cut, 5/8 inch.
- Equipped with geared type fence. Large, quick-acting guard. Accurate depth of cut scale.

### Jointer Knives

Made of finest quality, high-speed tool steel. Will hold a keen edge longer than most knives. Set of three, for jointer 99 P 2288.

Shipping weight, 4 ounces

9 P 2292 . . . . . \$2.70

### COMPANION Machine Stand

Use this all metal machine stand for mounting your heavy duty jointer. Has 10x34-inch top; height, 31 inches. Handy lower shelf for tools. Exceptionally strong and rigid. See page 35 for full and complete description.

Shipping weight, 39 pounds.

99 P 2719 . . . . . \$4.95

### COMPANION Tool Light

Use our handy light with your jointer, and have ample light where you want it, on your work instead of in your eyes. Extra large reflector guarantees this. Has 15-inch flexible neck, reflector and cord and plug.

See page 34 for full and complete description. Shipping weight, 2 lbs.

9 P 2264 . . . . . \$1.45

Page 21

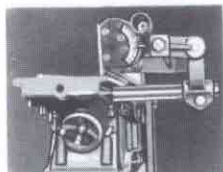

Note the sturdy construction, V-ways and highly efficient fence construction.



Note the large hand wheels and positive locks on the V-ways.

Easy Terms!  
ON ORDERS OF  
20 OR MORE  
-SEE INSIDE  
FRONT COVER

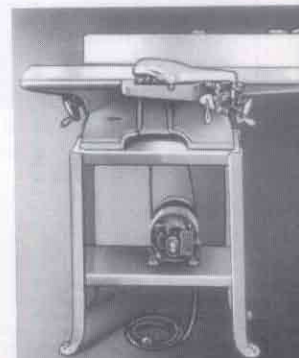

# CRAFTSMAN 9-INCH SWING 44-INCH BED FOR WOOD OR

REG. U. S. PAT. OFF.

- Double bearing headstock insures long life and permits large diameters to be turned outboard.
- Accurately ground spindle.
- Special auto-lubricating bronze bearings.
- Headstock ball thrust bearing insures smooth easy operation.
- Hollow headstock with  $\frac{3}{8}$  inch hole, accurately ground to take No. 1 Morse taper centers and arbors.



## The Lathe that Sets the Pace . . . Versatility

Truly a Pacemaker . . . If you are seeking utmost value in a lathe combined with a unique versatility that enables it to be used for wood or metal turning, you will make no mistake to select the CRAFTSMAN 9-inch Bench Lathe. It has the required capacity for most any job, due to its 9-inch swing and its 44-inch bed, with 30 in. between centers. It has accuracy required for metal working for which it may be easily and economically converted through the purchase of a few low-cost attachments.

Bearings are of the auto-lubricating bronze type, and will give practically limitless service. Specially fitted and installed they seal the spindle journals from grit and abrasive dust insuring greater life and accuracy. Longitudinal thrust is absorbed

by the ball thrust bearing in the headstock. Tailstock may be set over for turning tapers. It is equipped with self-ejecting center and ram lock. As pulley is mounted between headstock bearings you can do outboard turning with this lathe. The big, heavy bed is rigid and well braced. It is carefully machined from close grained gray iron. Note particularly the large size, the extra weight and sturdy construction.

The headstock is so designed as to enable the operator to readily shift the belt to the desired step of the headstock pulley for the proper speed. The headstock spindle has right hand threads inboard and left hand threads outboard, permitting the double threaded face plate No. 9 P 2090 to be used on either end of the spindle without the necessity of reversing the motor.

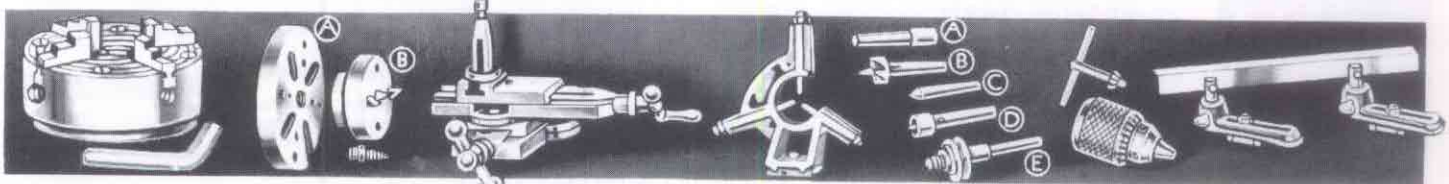

### 4-Jaw Independent Chuck

Equipped with four 4-inch reversible jaws that are rugged and well fitted. Supplied with a hexagonal key that is much easier to use than the square type. Supplied complete with back plate to fit our 9-inch CRAFTSMAN Lathe. Well made and a real value. Shipping weight, 4 pounds 4 ounces.

9 P 2156...\$4.65

### High Grade Face Plates

(A) 9 P 2090 —  $5\frac{1}{8}$ -inch wood or metal working face plate, nicely machined and balanced, double threaded, for either end of spindle, wood or metal work. Shpg. wt., 1 lb. 15 oz. . . . \$1.35  
(B) 9 P 2091 — 3-inch face plate with spurs, removable center and screw center. Shipping wt., 1 lb. 12 oz. . . . \$1.95

### Compound Tool Rest

Precision built throughout! Feed collars graduated to one thousandth of an inch. Angular dial graduated to 180 degrees. Transverse feed,  $5\frac{1}{16}$  inches; angular or longitudinal feed, 6 inches. Quality and value! (For tool bits and holders see page 27). Shipping weight, 19 pounds 4 ounces.

9 P 2168...\$11.95

### Quality Steady Rest

For supporting extra long work in lathe. Fitted with best quality brass jaws! Very essential when turning long, slender pieces in the lathe. Very sturdy and convenient to use. Shipping weight, 3 pounds 10 ounces.

9 P 2178...\$3.25

### Centers and Arbors

No. 1 Morse taper. Ground and hardened. Shpg. wt., each, 5 ounces.

(A) 9 P 2123 — Tapered chuck arbor . . . 59c  
(B) 9 P 2106 — Spur center . . . 59c  
(C) 9 P 2110 — 60 degree center . . . 59c  
(D) 9 P 2100 — Cup center . . . 59c  
(E) 9 P 2165 — Grinding arbor . . . 75c  
9 P 2132 — Chuck for use with 9P2165 arbor . 50c

### $\frac{1}{2}$ -Inch Jacobs' Chuck

For use on arbor 9 P 2123 at left. Extremely high quality throughout. These chucks are famous for their accuracy and long life. When fitted with arbor may be used either in lathe head or tailstock. Complete with key. Shipping weight, 2 pounds.

9 P 2142...\$5.65

### 18-Inch Tool Rest

Well made throughout. Built for long service. Well machined and nicely finished. A great convenience when making long turnings such as table legs or lamp spindles. Readily adjusted for height. Complete with bed brackets. Shpg. wt., 6 lbs. 5 oz.

9 P 2173...\$1.75

# BENCH LATHE

## METAL TURNING

\$12<sup>95</sup>



- Heavy gray iron bed, accurately milled and strongly webbed.
- Tailstock equipped with self-ejecting center, ram lock and set-over for taper turning.
- Four speeds ranging from 700 to 4000 revolutions per minute.
- Specially built headstock guarantees accuracy, rigidity and easy belt shifting for the various speeds required.
- Can be equipped for metal turning.
- Belt, motor pulley and accessories others charge for are included and make this lathe an even greater value.

### ... Value

The extra size and capacity of this lathe makes it well adapted to metal spinning. Its swing is large enough that it is unnecessary to place a gap in the bed which would handicap the metal worker in bringing the compound rest up close to the headstock for various operations. It is a well thought out design and its many advantages make it a truly fine all around lathe. We recommend use of 1/3-H.P. motor 99 P 5607. See page 31. Complete with extra 4-step "V" drive pulley, endless "V" belt, 8-inch tool rest and No. 1 Morse taper spur and cup centers. Shipping weight, 61 pounds.

99 PM 2018.....\$12.95

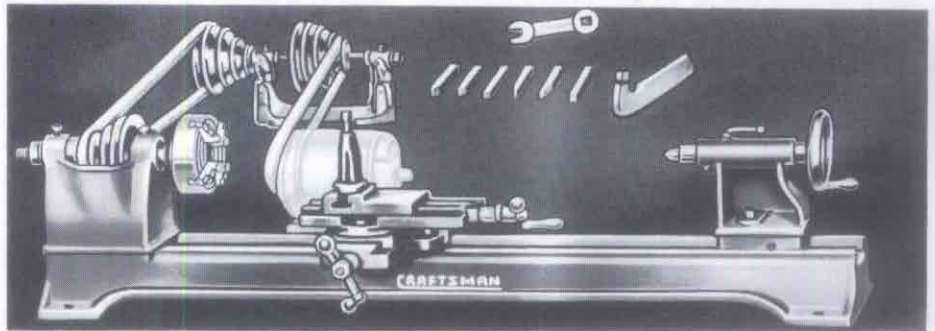

### Complete Metal Working Outfit

This fine metal working outfit includes our excellent CRAFTSMAN 9-in. swing lathe, an exceptionally high quality compound rest having collars graduated to one-thousandth of an inch, angular dial from zero degrees to 180 degrees, longitudinal feed of 6 inches and a transverse feed of 5 3/16 inches, complete with production type tool post, tool holder, six tool bits ground ready for use, wrenches, multiple speed Jack shaft and sturdy 4-inch 4-jaw chuck, belt, pulleys and '60 degree center. Shipping weight, 93 pounds.

Easy Terms  
ON ORDERS OF  
\$10 OR MORE  
SEE INSIDE  
FRONT COVER

99 PM 2020—Complete Outfit.....\$33.50

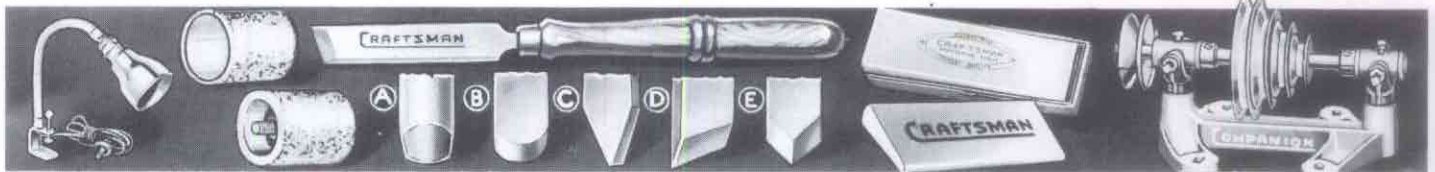

#### COMPANION Tool Light

Designed especially for power tool use. You can clamp it handily on your lathe to throw the light exactly where you want it. Reflector keeps light out of your eyes. Complete with 15 in. flexible neck, reflector, cord and plug. Shipping weight, 2 lbs.  
9 P 2264.....\$1.45

#### Sanding Drum and Sleeves

The use of this drum on your lathe enables you to do a laborious sanding job in a hurry. Fits grinding arbor 9 P 2165. With adapter and 2 sleeves. Shpg. wt., 1 lb. 2 oz.  
9 P 2520—Sanding Drum.....98c  
9 P 2522—2 3/16-in. Sanding Sleeves. Coarse, medium or fine. State grade. Shpg. wt., 2 oz. Each...10c

#### CRAFTSMAN Wood Turning Chisels and Gouges

Highest quality tool steel 4-in. blades. Carefully tempered; keep a keen edge. 8-in. handles. Shpg. wt., 11 oz.

(A) Gouges	(B) Round Nose	(C) Parting Tool
9 P 2850—1/4 in. wide.....	9 P 2856—1/2 in. wide.....	9 P 2858—3/8 in. wide.....
9 P 2851—1/2 in. wide.....	9 P 2854—1/2 in. wide.....	
9 P 2852—3/4 in. wide.....	9 P 2862—1/2 in. wide.....	
	9 P 2863—1 in. wide.....	

#### CRAFTSMAN Sharpening Stones

Make your tools sharp and bright in a jiffy. One side of the sharpener has a fine grit, the other a coarse grit. Size, 7x2x1 in. Shipping weight, 14 ounces.  
9 P 6440.....\$1.25  
CRAFTSMAN Slip Stones  
This slip stone will give your gouges and other round shaped tools a keen edge that will bite through any kind of wood with ease. Medium grit. Shipping weight, 12 ounces.  
9 P 6454.....45c

#### Bronze Bushed Jack Shaft Stand

Use this handy jack shaft stand to secure proper lathe speeds for metal working. Also useful on other tools for increasing or decreasing speeds. Bolt holes are spaced identically with those found on motors, permitting it to be used on motor bases of machines, etc., for greatest convenience. Complete with bronze bushed self-aligning bearings. Shpg. wt., 6 lbs. 4 oz.  
9 P 2494—Specify 4-inch 4-step pulley.....\$2.45



## The FINEST and Most VERSATILE

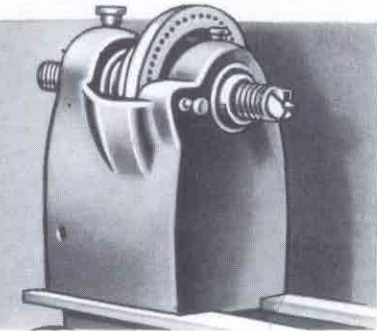

A massive specially designed headstock fitted with heavy duty, deep groove precision ball bearings. The accurately made spindle accommodates No. 2 Morse taper arbors and centers, the nose has an accurately cut right hand thread; the outboard end has a left hand thread eliminating the necessity for reversing for outboard work. The well balanced 4-speed pulley has 60 accurately spaced holes for indexing, dividing, etc. Large spring loaded indexing lock.

Realizing the need of the advanced and professional craftsman as well as of thousands of schools, pattern shops and woodworking establishments for a very fine wood-turning lathe, we developed the now famous CRAFTSMAN Universal Heavy Duty Lathe, an outstanding engineering development. We set the price so low that any one now can afford to own this lathe! In buying it you save at least 50%. In addition, you get a lathe that you can convert to a precision-type metal turning and screw-cutting lathe by adding the necessary parts and accessories! You can get the same metal cutting accuracy and durability in our Universal Wood Turning Lathe as in the best screw cutting lathe offered by any manufacturer under \$100.00. Great care is used in machining, assembling and testing this lathe. Every job that can be handled on a wood turning lathe or on a metal working, screw-cutting lathe

can be done on the CRAFTSMAN Universal Heavy Duty. The heavy semi-steel bed with its broad, accurately machined ways, is husky enough to resist all torsional stresses.

The headstock of our No. 99 PM 2024 Lathe is provided with deep groove S.K.F. ball bearings, has 1-in. hollow steel spindle machined for No. 2 Morse taper, and will pass 1/2-inch rod. The headstock 4-speed pulley is accurately indexed.

The headstock of No. 99 PM 2026 Lathe is fitted with high speed line reamed babbitt bearings with laminated shim adjustment, insuring utmost accuracy. The spindle is 1 1/2 inches in diameter and will pass a 3/4-inch rod. The headstock pulley is accurately indexed.

The tailstock is heavy duty type, may be set over for tapers, and is fitted with self-ejecting No. 2 Morse taper cup center and coordinate ram lock.

## THESE UNITS WILL CONVERT YOUR UNIVERSAL LATHE



**Metal Turning Outfit.** This is an outfit that is essential for use in metal turning and we recommend that you include it in your order when buying parts necessary to convert your universal lathe to a metal turning screw cutting job. Specify catalog number of your lathe it is to be used with. Consists of two No. 2 Morse taper 60-degree centers, tool holder, 2 tool bits, 1-in. dog and 6-in. face plate.  
Shipping weight, 4 lbs. 12 oz.  
**9 P 2068.....\$5.95**

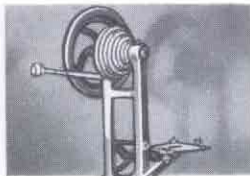

**Countershaft Assembly.** A valuable addition to your lathe for metal working. Selection of 8 speeds: 130, 255, 390, 455, 760, 865, 1360, 2540. Low speeds are entirely practical for 2-in cold rolled steel, 2 1/2-in. cast iron or a 5-in. armature when used with the proper feed. Specify catalog number of your lathe.  
Shpg. wt., 24 lbs.  
**9 P 2072.....\$11.95**

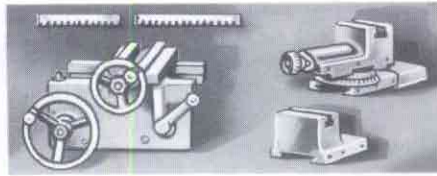

**9 P 2074—Carriage and Rack Assembly.** Carriage fitted with half nuts for later addition of lead screw; also adjusting gib and locking gib. Shipping weight, 20 lbs. 10 oz.....**\$12.95**  
**9 P 2070—Carriage Compound Rest.** Fitted with adjusting gib, accurately calibrated 180-degree protractor, feed screw collar calibrated for .001-in. feed. Shipping weight, 7 lbs. 9 oz.....**\$9.65**  
**9 P 2066—Carriage Plain Rest.** An economical unit for jobs not requiring swivel feature. Shipping weight, 5 lbs. 8 oz.....**\$4.95**  
**9 P 2064—Tool Post** complete, for use with plain or compound rests. Shpg. wt., 1 lb.....**\$2.00**

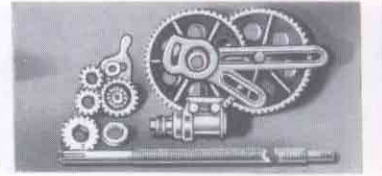

**Lead Screw and Feed Gears.** Used with 9 P 2074 carriage and rack assembly (and 9 P 2066 carriage plain rest or 9 P 2070 carriage compound rest) produces longitudinal power feed to carriage of .0087 or .0043 in. per revolution of spindle. Power feed produces much smoother cuts because the carriage advances a regular amount for each revolution of the spindle. Reverse feed mechanism included. Complete with fittings for attaching to lathe.  
Shpg. wt., 16 lbs. 4 oz.  
**9 P 2060.....\$12.95**

# CRAFTSMAN

REG. U. S. PAT. OFF.

## UNIVERSAL HEAVY DUTY LATHE

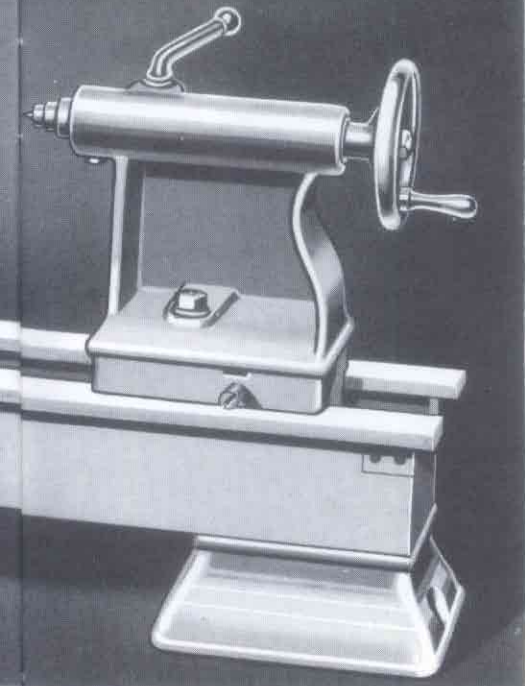

- Heavy, rugged, semi-steel bed; ways accurately ground and finely finished.
- Massive heavy duty headstock equipped with highest quality deep groove dust proof precision type ball bearings.
- Double threaded hollow spindle, accurately machined for No. 2 Morse taper arbors and centers. Passes 1/2-inch rod.
- 4-speed pulley with 60-hole spindle indexing mechanism for dividing.
- Accurate spindle thrust adjustment.
- Heavy duty tailstock has exceptionally broad base. May be set over for turning tapers, accurate witness mark, fitted with automatic center ejector and coordinate lock. Quill machined and ground for No. 2 Morse taper center.
- Wide speed range—700 to 4300 R.P.M. Countershaft gives following speeds: 130, 255, 390, 455, 760, 865, 1360 and 2540 R.P.M.
- Convertible for metal turning or screw cutting.

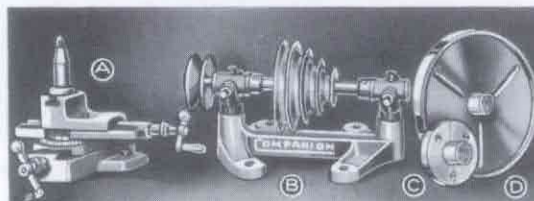

- (A) 9 P 2076—Direct Bed-Attached Compound Rest. Feeds calibrated to .001 in. Swivel to 180 degrees. 2 anchor studs. Shpg. wt., 24 lbs. \$13.25
- (B) 9 P 2494—4-Step Jack Shaft Stand. Decrease speed for metal working. It increases cutting power. Specify 5-in., 4 steps. Shpg. wt., 7 lbs. \$2.55
- Face Plates. 1-inch 8-thread. (C) 9 P 2085—3 1/2". Shpg. wt., 2 lbs. \$1.20 (D) 9 P 2086—9". Shpg. wt., 6 lbs. \$2.45



- (A) 9 P 2138—4-in. Independent Chuck. Reversible jaws. Fits spindle of 99 PM 2024. Shpg. wt., 4 lbs. \$4.85
- (B) 9 P 2142—1/2-inch Jacobs Chuck. Key chuck with special taper. Shpg. wt., 2 lbs. \$5.65
- (C) 9 P 2124—No. 2 Morse Taper Arbor. For Jacobs' chuck. Shipping weight, 7 ounces. \$75c



- (A) 9 P 2520—Drum Sander. 2 sleeves and adapter. Shpg. wt., 1 lb. 2 oz. \$98c
- (B) 9 P 2522—Sleeves. Fine, medium or coarse. Shpg. wt., 2 oz. Ea. \$1.00
- (C) 9 P 2212—Sanding Attachment. Used with lathe, sanding discs on page 20 and face plates above. Shpg. wt., 5 lbs. \$2.75
- (D) 9 P 2063—24-inch Tool Rest. Complete with bed brackets. Shpg. wt., 9 lbs. \$2.75



- Lathe Centers. With No. 2 Morse taper shank. Accurately ground and hardened. Shipping weight, each, 7 oz.
- (A) 9 P 2107—Spur Center.....65c
- (B) 9 P 2101—Cup Center.....65c
- (C) 9 P 2111—60 Degree Center.....65c
- (D) 9 P 2115—Screw Center. No. 2 Morse taper shank. Shipping wt., 14 oz. \$95c



- No. 2 Morse Taper Arbors. (A) 9 P 2125—With 1/2-in. chuck. Shpg. wt., 1 lb. 8 oz. \$1.19 (B) 9 P 2163—For grinding, etc. Shpg. wt., 13 oz. \$89c
- (C) 9 P 2161—Adapter Sleeve. No. 2 to No. 1 Morse taper. Shpg. wt., 5 oz. 75c (D) 9 P 2264—Tool Light. Shpg. wt., 2 lbs. \$1.45

## Lathe on the Market!

The CRAFTSMAN Universal Heavy Duty Lathe is not only the finest wood working lathe we have ever seen but opens up entirely new fields. It grows with your shop! It actually gives you two lathes in one, because you can easily and economically add the necessary parts to your universal wood working lathe to convert it into a genuine precision type metal working and screw cutting lathe, doing so as is convenient and the need arises. All necessary holes for attaching these added parts are already drilled and tapped when you buy your Universal Lathe for wood working purposes.

We have sold many thousands of these lathes for use in both wood working and metal turning. Users tell us it is the most satisfactory combination they ever added to their shop equipment.

### SPECIFICATIONS

Swing over bed: 12 1/4 inches.  
Length, over all: 54 inches.  
Height, over all: 16 inches.  
Depth, over all: 7 inches.  
Maximum distance between centers: 36 inches.  
Number of Speeds: 4  
Tailstock set over: 3/4 inches.

99 PM 2024 has a 3/16-in. hole through spindle, the spindle nose is 1 in. at both ends (8-thread), and the headstock spindle has a No. 2 Morse taper. Speed range, 690, 1295, 2300 and 4310.

99 PM 2026 has a 3/4-in. hole through spindle, the spindle nose is 1 1/2-in. (8-thread) and the headstock spindle has a No. 3 Morse taper (with sleeve to No. 2). Speed range, 575, 1035, 1725, and 2875.

99 PM 2024—CRAFTSMAN Universal Ball Bearing Heavy Duty Lathe complete with centers, belt, tee rest, wrench and motor pulley. Shipping weight, 147 pounds. \$32.50

99 PM 2026—Same as above but fitted with high speed line reamed babbit bearing headstock for later addition of back gears, etc. Shipping wt., 185 lbs. \$34.50

Easy Terms!  
ON ORDERS OF 120 OR MORE  
-SEE INSIDE FRONT COVER

## INTO A PRECISE METAL-WORKING SCREW CUTTING LATHE

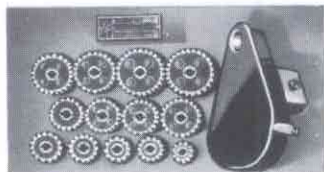

**Thread Gears and Chart.** With power feed assembly, opens up whole new field of thread cutting possibilities. For cutting 4 to 72 threads per inch, (left or right) including pipe threads. Shipping weight, 4 lbs. 4 oz.

9 P 2056.....\$5.95

**Switch and Gear Guard Assembly.** Offers maximum convenience and safety to operator. Complete with all fastenings and motor wire for switch. Shipping weight, 4 lbs. 14 oz.

9 P 2054.....\$4.25



**Thread Dial.** Simplifies thread cutting by indicating when to engage carriage, prevents spoilage. Shipping weight, 5 ounces.

9 P 2052..\$1.50

**Steady Rest.** Brass jaws. Required for long turnings; assists in maintaining accuracy. Shipping weight, 7 pounds.

9 P 2050..\$4.25



**Back Gears.** For attachment to special babbit bearing headstock lathe No. 99 PM 2026 (or 99 PM 2028, page 27). With countershaft attachment, provides 16 speeds. Lowest speed, 28 R.P.M. Makes possible the greatest range and capacity of work for metal working lathe.

All necessary parts and fittings are supplied to fit the drilled and tapped holes of 99 PM 2026 lathe. Shipping weight, 13 lbs.

9 P 2058.....\$7.95

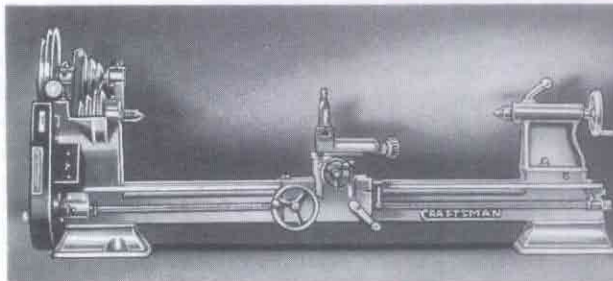

We believe the CRAFTSMAN Universal lathe and its accessories to be the most flexible group of lathe equipment ever offered. This lathe is the finest wood working lathe we have ever seen! Fitted with compound rest, centers, etc. it is an excellent armature lathe, or by the adding of other equipment it can be built into a most accurate screw cutting metal working lathe.

**\$63<sup>50</sup>**  
CASH  
36 in. Bed  
99 PM 2028

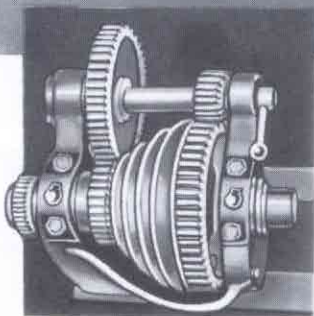
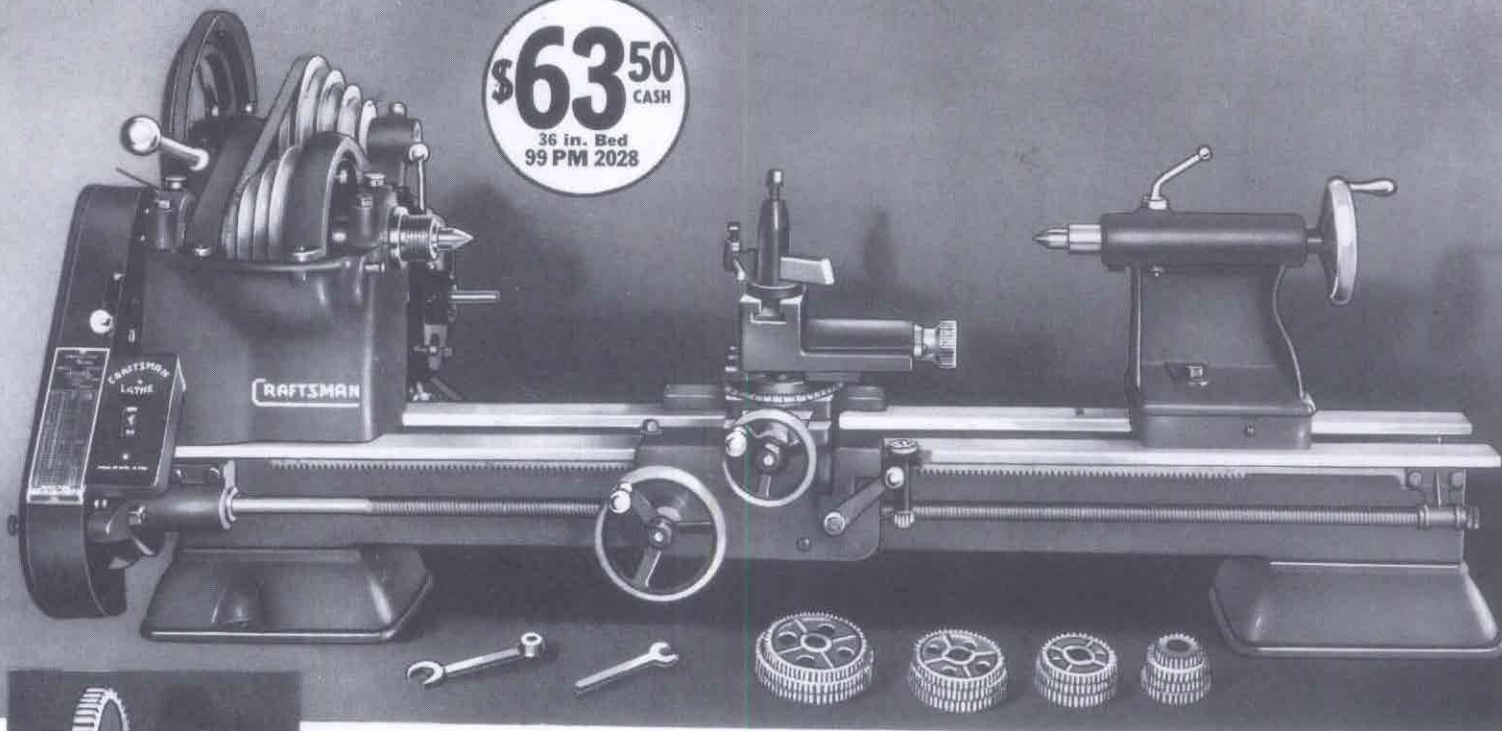

# Precision construction and fine materials make it the biggest value ever offered . . . . .

## FEATURES:

- Heavily reinforced semi-steel bed with precision-ground ways. Large box-type engine lathe legs insure firm foundation; heavy cross bracing prevents warping and resists torsional stress.
- Mogul type semi-steel headstock with high speed line reamed babbitt bearings. Laminated shims compensate for wear; with convenient accurate thrust adjustment.
- Rugged semi-steel tailstock has set-over for taper turning. Fitted with center ejector and coordinating ram lock, with ram graduated in sixteenths of an inch.
- Back gears are 12-pitch 7/8-in. face special type, giving power to spare. Fitted with lock and handy lever to bring gears into mesh.
- Non-slip V-belt drive with adjustable belt tension and release lever provides sixteen speeds. Belt tension may be adjusted in 5 seconds.
- Countershaft is integral part of the lathe, a complete self-contained unit including motor mounting.
- Heavy semi-steel carriage has adjustable gibs for take-up, positive lock, threading dial, etc.
- Compound rest swivels and locks at any angle and is graduated in one degree divisions from 0 to 180°.
- Gears furnished to cut all standard right and left hand threads from 4 to 80, including Vee pipe thread.
- Reverse gear is controlled by convenient hand lever at left of headstock for quickly reversing lead screw. (See lever above chart.)

Great strength, symmetry of design and quality of workmanship have been incorporated in this lathe . . . We invite you to compare it feature for feature, specification for specification, with any other lathe anywhere near its price class. When you have done this you will agree with us that this is the lathe for you to buy . . . and will not be satisfied until you have added this beautiful piece of equipment to your shop.

Sears designed this remarkable lathe over a year ago. The great numbers in use have proven it to be an outstanding development. It is a thoroughly tried machine possessing features found on no other lathe regardless of price. The compact countershaft assembly gives it great stability and cutting power. Its accurately indexed headstock pulley, its convenient lead screw reversing control, extra sturdy construction and many other features recommend it to the experienced lathe user.

## SPECIFICATIONS

- Swing over bed: 12 1/4 in.
- Swing over carriage: 8 3/4 in.
- Maximum distance between centers: See table of bed lengths.
- Length over all: 45 in. (42-in. bed.)
- Height over all: 19 in.
- Depth over all: 25 1/2 in.
- Hole through spindle: 25/32 in.
- Spindle nose: 1 1/2 in. dia. 8 threads.
- Taper in headstock spindle: No. 3 Morse, sleeve to No. 2 Morse.
- Taper in tailstock spindle: No. 2 Morse.
- Number of speeds: 99PM2028, 8; No. 99PM2030, 16.
- Speed range: No. 99PM2028: 170, 270, 430, 504, 680, 832, 1298 and 2100.
- Speed range: No. 99PM2030: 32, 50, 74, 88, 120, 142, 170, 210, 270, 350, 430, 504, 680, 832, 1298 and 2100.
- Thread cutting range: 4 to 80, right or left hand.
- Lead screw: 8 Acme threads per in.
- Cross slide travel: 6 3/8 in.
- Compound rest angular travel: 2 3/8 in.
- Tailstock set over: 3/4 in. Has witness mark and graduated ram.

## Special Lathes—Longer Beds

### 8 Speed CRAFTSMAN Lathe

Catalog No. 99 PM 2028  
Vee Belt Counter Shaft Drive.

Bed Length	Cap. btwn. ctrs.	Less Motor	
		Shpg. Wt.	Price
Standard			
36 in.	18 in.	195 lbs.	<b>\$63.50</b>
42 in.	24 in.	210 lbs.	<b>\$69.95</b>
48 in.	30 in.	220 lbs.	<b>77.95</b>
54 in.	36 in.	237 lbs.	<b>85.95</b>

### 16 Speed CRAFTSMAN Lathe

Catalog No. 99 PM 2030  
Back gear and countershaft drive.

Bed Length	Cap. btwn. ctrs.	Less motor	
		Shpg. Wt.	Price
Standard			
36 in.	18 in.	205 lbs.	<b>\$74.95</b>
42 in.	24 in.	220 lbs.	<b>\$77.95</b>
48 in.	30 in.	230 lbs.	<b>\$85.95</b>
54 in.	36 in.	246 lbs.	<b>93.95</b>

# MASTER CRAFTSMAN

REG. U. S. PAT. OFF.

# 12-INCH SCREW CUTTING LATHE

**New Standards of Accuracy... Finer Design... Unbelievable Smoothness... Tremendous Power!**

Sears is the largest distributor of bench lathes in the world. Sears tools exhibit leadership not only in design but also in the use of the latest metallurgical advances which have been thoroughly tried. They use the best type of material for every part, the correct design and accurate machine work. Weight has significance only in terms of strength and stability.

To understand why our CRAFTSMAN 12-inch Screw Cutting Lathe is able to set new standards of accuracy... operate with unbelievable smoothness... have such tremendous power... it is necessary to know just how the lathe is made.

**BED.** In machining the heavy bed a rough milling cut is first taken, after which the bed is allowed to season thoroughly; later the finishing milling cut is taken. The work is then checked for accuracy, alignment, etc., and then is given a precision finish on a special Norton surface grinder. It is then given a final precision checking on a Brown and Sharp master surface plate, a process which assures you greater accuracy and satisfaction.

**HEADSTOCK.** Semi-steel precision milled and machined. The bearings then are filled with high grade babbit in a special fixture. Headstock is then assembled to the bed of which it is a component part and bored in a precision boring fixture, guaranteeing accurate alignment with the bed. Be sure the lathe you buy is fitted with this high quality and type of headstock bearings and full double screw caps.

**SPINDLE.** 1 1/4-in. diameter. Made from special alloy steel accurately ground and tested to closest limits. Special machining operations insure that the bore is absolutely concentric with the outside diameter. Convenient lock collar provides adjustment for thrust take-up.

**TAILSTOCK.** The semi-steel tailstock is aligned with headstock spindle by a special test arbor. The smallest error is corrected before lathe is permitted to pass inspection.

Every lathe is run through an actual test cut and the work checked for accuracy. At a distance of 4 inches from the spindle the work must show .001 in. or less taper. Headstock spindle, tailstock ram alignment are also checked to similarly close limits.

If you choose the CRAFTSMAN you get a lathe with mammoth swing (12 in.), heavy vibrationless construction, wide speed range. Eight or sixteen speeds according to the model chosen, reverse feed lever, 4 to 80 thread cutting range, power feed, integral drive, quick change speed control with belt tension adjustable in five seconds. The finest precision workmanship throughout!

**99 PM 2028**—CRAFTSMAN 12-inch 8-speed, screw cutting lathe, 36-inch bed, 18 inches between centers with compact unit countershaft and high speed line reamed headstock bearings, compound rest thread cutting gears and reversible feed, wrenches, belts, etc. all ready to attach motor and use. Shpg. wt., 195 lbs. .... **\$63.50**

**99 PM 2030**—CRAFTSMAN 12-inch lathe as above but also equipped with back gears, 16 speeds and 42-inch bed with 24 inches between centers. The most outstanding value we have ever seen. Shipping weight, 220 pounds ..... **\$77.95**

**Easy Terms!**  
ON ORDERS OF \$20 OR MORE - SEE INSIDE FRONT COVER

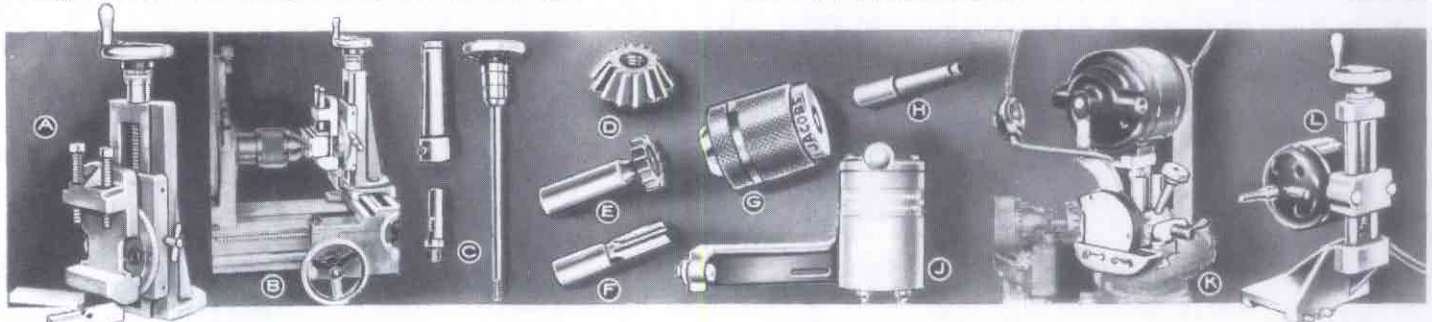

- (A) Milling Attachment**  
Complete as shown, with graduated swivel vise, V-block for holding round work and flat work. Capacity: 2 1/2 in. Vertical feed: 2 3/4 in. Cross feed: 5 in. Has micrometer graduated feed screw. Shpg. wt., 13 lbs.  
**9 P 2993 ..... \$13.50**
- (B) Milling attachment in use.**
- (C) Holding Collet**  
For straight shank cutters. Furnished with 2 arbors, one to take threaded hole angular cutters, etc. Shpg. wt., 2 lbs. 8 oz.  
**9 P 2994 ..... \$5.65**

- (D) 9 P 2995—Angular.** For face milling or dovetailing. State size.  
Diam., 1 1/4 in., 3/16 in. thick. Hole 1/2 in. .... **\$3.15**  
Diam., 1 1/2 in., 3/16 in. thick. Hole 1/2 in. .... **3.50**
- (E) 9 P 2996—Wood-ruff Keyway Cutters.** 1/2-in. shank. State size.  
Diam. Thick. Price  
1/2 in. 1/8 in. **\$1.65**  
3/4 in. 1/8 in. **1.80**  
1 in. 1/8 in. **2.20**  
1 1/4 in. 1/8 in. **2.60**  
1 1/2 in. 1/8 in. **2.90**
- (F) 9 P 2997—R.H. cut, R. H. Spiral End Mills.** State size.  
Diam. Flute Price  
1/2 in. 1/8 in. **\$1.10**  
3/4 in. 1/8 in. **1.20**  
1 in. 1/8 in. **1.30**  
1 1/4 in. 1/8 in. **1.50**  
1 1/2 in. 1/8 in. **1.70**
- Shipping weight, above cutters, each, 8 oz.

- (G) Center Rest Chuck**  
(Used in tailstock spindle to hold centerless armatures. Shipping wt., 3 lbs. 6 oz.  
**9 P 2991 ..... \$7.50**
- (H) Chuck Arbor**  
**9 P 2126**—For use with center rest chuck in head or tailstock. Shipping weight, 10 oz. .... **55c**
- (J) Reversing Switch**  
Essential when grinder is used on lathe. Permits changing direction of rotation of lathe spindle at will. Not for repulsion-induction motors. Shpg. wt., 7 lbs.  
**9 P 2992 ..... \$5.95**

- (K) Universal Tool Post Grinder**  
Grinds valves and cutters at any angle. Also pistons, bushings, reamers, valve stems, lathe centers. Undercuts mica. Complete with motor, external and internal grinding wheels, quill for internal grinding. 5 undercut (ing saws; diamond wheel dresser. Shipping weight, 24 lbs.  
**9 P 2998 ..... \$44.00**
- (L) Mica Undercutting Attachment**  
Fastens to back of carriage, out of way, yet can be put into action in a few seconds. When using undercutter it is not necessary to remove cutting tool or tool holder. Complete with motor, switch, cord, and set of 5 undercutting saws. Shpg. wt., 12 lbs.  
**9 P 2989 ..... \$18.95**



- (A) Tool Light**  
Throws the light exactly where you want it. Has flexible neck and extra large reflector. Complete with cord and plug. Shpg. wt., 1 lb. 12 oz.  
**9 P 2264 ..... \$1.45**

- (B) Center Gauge**  
For testing lathe centers and setting threading tool. Tempered steel. Shpg. wt., 1 oz.  
**9 P 4064 ..... 40c**
- (C) Center Drill**  
With countersink. High grade steel. 3/32 or 1/8-in. diameter. State size. Shpg. wt., 1 oz.  
**9 P 2061 ..... 25c**

- (D) Follower Rest**  
For jobs requiring a long cut on small diameters. Fastens to back of carriage—follows cutting tool. Shpg. wt., 4 lbs.  
**9 P 2988 ..... \$2.45**
- (E) Face Plate**  
8 1/2 inches in diameter. Shipping weight, 6 lbs. 4 oz.  
**9 P 2087 ..... \$3.50**

- (F) Crotch Center**  
**9 P 2114**—Shpg. wt., 1 lb. .... **\$1.50**
- (G) Micrometer Carriage Stop**  
Insures accurate turning. Shipping weight, 9 ounces.  
**9 P 2185 ..... \$3.25**
- (H) Drill Pad**  
**9 P 2187**—Shipping wt., 1 lb. 2 oz. .... **\$1.50**

- (J) 8-Pc. Tool Post Tool Set**  
High speed tool steel. Includes set of tool post spacers, 1/2-in. threading tool, 3/8-in. turning tool, 1/2-in. outside turning tool, 4 boring tools, 3/16, 1/4, 3/8, 1/2 in. Shipping wt., 1 lb. 6 oz.  
**9 P 2189 ..... \$3.95**



- Tool Holders**  
Steel forgings, carefully finished. For 1/2-in. tool bits. Shipping weight, each, 13 ounces.  
**(A) 9 P 2198—Threading ..... \$2.35**  
**(B) 9 P 2202—Knurling Tool ..... 2.85**  
**(C) 9 P 2192—Offset, Right ..... 1.00**  
**(D) 9 P 2196—Straight ..... 1.00**  
**(E) 9 P 2194—Offset, Left ..... 1.00**  
**(F) 9 P 2208—Cut-Off ..... 1.50**

- 6 Formed Tool Bits**  
High speed steel, 1/2 in. Shpg. wt., 6 oz. Set consists of:  
**(G) Threading Tool**  
**(H) R. H. Turning Tool**  
**(J) R. H. Facing Tool**  
**(K) Round Nose Turning Tool**  
**(L) R. H. Facing Tool**  
**(M) L. H. Turning Tool**  
**9 P 2205—Set of 6 ..... \$1.00**

- (N) 5-in. Universal Scroll Chuck**  
Three jaws move simultaneously, to firmly grip round or hexagonal work. Complete with 2 sets of jaws and adapter to fit spindle nose. Shpg. wt., 6 lbs. 11 oz.  
**9 P 2150 ..... \$16.75**
- (P) 6-in. Independent Chuck**  
Fitted with adapter for spindle nose. Shipping weight, 8 pounds 12 ounces.  
**9 P 2146—Each ..... \$9.45**

- (R) Steady Rest**  
For long, slender work. Brass jaws. Cap. up to 2 1/2 in. Shpg. wt., 6 lbs.  
**9 P 2050 ..... \$4.25**
- (S) Spindle Nose Chuck**  
Hollow, takes 3/8 to 1/2-in. Replaces draw-in and collets. Shpg. wt., 4 lbs.  
**9 P 2144 ..... \$9.00**

- (T) Lathe Dogs**  
**9 P 2183**—Drop forged. State size wanted.  
Size Shpg. Wt. Price  
1/2 in. 4 oz. **40c**  
3/4 in. 6 oz. **50c**  
1 in. 7 oz. **60c**  
1 1/2 in. 14 oz. **70c**

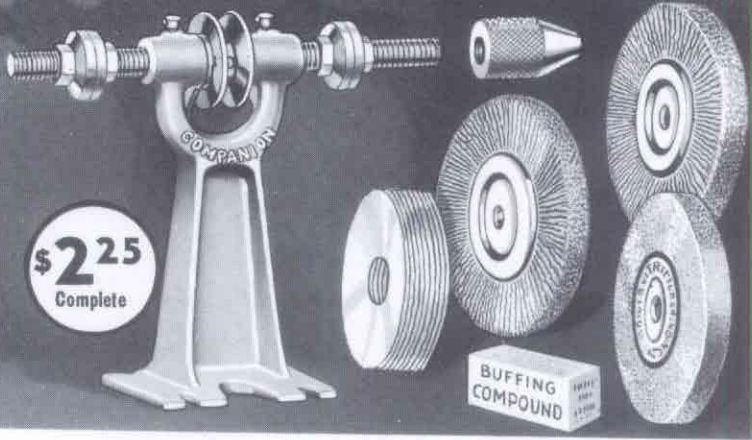

## COMPANION Polishing Outfit

Handiest of all small tools for home and shop. This handy 7-piece outfit will quickly and efficiently sharpen tools, remove rust or paint, grind and polish metals, and may also be used for drilling. The set includes the polishing head, height, over all, 6½ inches; ¼-inch chuck; clamping collars; 4x½-inch vitrified grinding wheel; 4-in. wire wheels, one coarse and one fine; a 6-inch cloth buffer and cake of buffing compound.

- 9 P 2869—Complete Polishing, Grinding and General Utility Outfit. Shipping weight, 4 pounds 10 ounces..... \$2.25  
 9 P 2871—Polishing Head only, less chuck. Shipping weight, 3 pounds 12 ounces..... .69  
 9 P 2872—Same as 9 P 2871 but with bronze bearings..... .89  
 9 P 2130—¼-in. Chuck only. Shipping weight, 6 ounces..... .23

Easy Terms! ON ORDERS OF \$20 OR MORE SEE INSIDE FRONT COVER



## COMPANION No. 2 Polishing Head

Larger and heavier than our 9 P 2871 Polishing Head and built for harder service. Fitted with heavy, high quality bronze bearings and sturdy ½-inch steel shaft. Will accommodate a wheel on either end, up to ¾ in. thick. May be driven from above, behind or below.

**FRAME:** Sturdy semi-steel, well ribbed for extra strength. Height, over all, 8½ inches.

**CHUCK:** Excellent quality 3-jaw type, finely finished; capacity up to ¾ in.

- PULLEY:** 2¼-in. diameter, V-type.  
**SPINDLE:** Selected steel shafting, threaded both ends, ½-in. diameter.  
**CLAMPING COLLARS:** Sturdy, well made; cut from solid steel, insure the true running of wheels and accessories.  
 This is unquestionably the finest low priced polishing head on the market. Order it today for your shop. Shipping weight, 8 pounds 4 ounces.  
 9 P 2873..... \$2.45

## COMPANION 4-INCH GRINDER

You could hardly make a better investment for the purpose of keeping your tools in A-1 condition than to order this sturdy, well-built 4-inch grinder. Specially designed frame enables grinder to be driven from above, below or behind. Read these specifications!

- FRAME:** Close grained gray iron, ruggedly designed for the hardest kind of service.  
**SPINDLE:** Selected steel, 5/8 inch in diameter, turned down to ½ inch to fit all standard wheels and accessories. Takes standard chucks.  
**PULLEY:** 1¾-in. diameter, V-type.  
**TOOL RESTS:** Large, sturdy; provide steady support. Fully adjustable.  
**GRINDING WHEELS:** Two 4x¾-in. wheels, one fine and one coarse.  
**CLAMPING COLLARS:** Husky oversize type to hold wheels firmly.  
 A QUALITY 4-inch grinder complete with TWO grinding wheels and tool rests. Just what you need to do the many grinding and sharpening jobs which will make your tools easier to use. Shipping weight, 6 pounds 2 ounces.  
 9 P 2600..... \$1.95

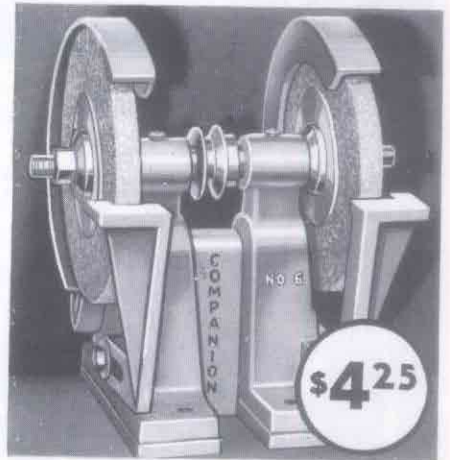

## COMPANION 6-INCH GRINDER

An exceptionally fine grinder that will save you many hours in sharpening your tools. When fitted with wire scratch wheels, it readily removes rust or paint. It polishes metals when fitted with cloth buffers. A real value. We designed it especially for the man who wants the increased production capacity of 6-inch wheels mounted in a much heavier frame than our 9 P 2600. Will give a lifetime of service.

**FRAME:** Extra-strong and well ribbed; made of finest quality close-grained gray iron.

**SPINDLE:** Full ¾-in. diameter, turned down to ½ in. at ends to fit all standard wheels, chucks and accessories.

- BEARINGS:** Heavy bronze; extra long; ¾-in. diameter. The extra length insures long life.  
**GUARDS:** Fine gray iron; fully adjustable.  
**TOOL RESTS:** Heavy gray iron; fully adjustable.  
**GRINDING WHEELS:** TWO fast cutting 6-inch wheels, one coarse and one fine.  
**CLAMPING COLLARS:** Extra sturdy, with faced plates to hold wheels tightly.  
 You can drive this grinder from above, below or behind. Your home or shop should have this essential tool! Shipping weight, 15 pounds.  
 9 P 2602..... \$4.25

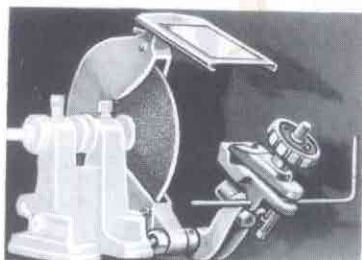

## CRAFTSMAN

### METAL CUTTING ATTACHMENT

Mount this attachment on your bench grinder and you are fully equipped to cut steel, iron, brass and copper rods, tubing, springs, etc. (Special wheel can be supplied for ceramic materials.) Work is held in V-shaped hinged vise for feeding against wheel. Attachment includes 8x½-in. special metal-cutting wheel, housing and guard, with safety glass eye shield, bracket for attaching. (Grinder base not included.) Shipping weight, 13 pounds.

- 9 P 2612..... \$3.50  
 9 P 6470—8x½-in. rubber-bonded abrasive wheel. Made for cutting steel, iron and other metals. Specify ½-in. center hole. Shipping weight, 1 lb. 14 oz..... \$1.00

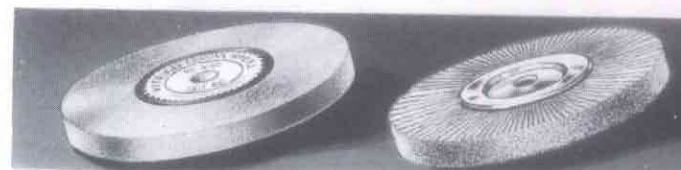

### Grinding Wheels

COMPANION fully vitrified grinding wheels. Faced on cutting edge. Furnished with any size arbor hole up to 1 in. Be sure to state diameter and hole size. Shpg. wt., 4-in. wheels, 1 lb.; 6-in., 2 lbs.

- 9 P 6413  
 4x½-in. Medium grit..... 35c  
 4x¾-in. Medium grit..... 43c  
 6x½-in. Coarse grit..... 59c  
 6x½-in. Fine grit..... 59c

### Scratch Wheels

Highest quality, carefully made and accurately balanced steel wire wheels. 4-in. size has ½-in. arbor hole; 6-in. has ¾ or ¾-in. hole. State size wanted. Shpg. wt., 4-in. size, 7 oz.; 6-in., 9 oz.

- 9 P 6480—4-in. Coarse..... 35c  
 9 P 6482—4-in. Fine..... 45c  
 9 P 6480—6-in. Coarse..... 45c  
 9 P 6482—6-in. Fine..... 55c

An attachment for your bench grinder that enables you to cut metal, tile, brick, terra cotta, etc., with ease and speed.

# COMPANION

## UTILITY GRINDER

- 1/4-H.P. ball bearing motor 3450 R.P.M., full load speed (3600 R.P.M. no load). Operates on 110-volt 60 cycle A.C. Fully guaranteed.
- Built in toggle switch.
- Two 6x3/4 in high quality vitrified grinding wheels.
- Removable and adjustable wheel guards.
- Adjustable tool rests.
- Sturdy selected steel mandrel turned to 1/2 in. at ends.
- Complete with 6-ft. rubber covered cord and plug.

We sincerely believe this to be the biggest money's worth in a motor driven general utility grinder that was ever offered anywhere, by anyone. Certainly the price is a revelation in Sears value-giving! And the quality is there, too! The smooth-running 1/4-H.P. ball bearing motor has ample power for nearly every grinding job. The big 6-inch vitrified grinding wheels, 3/4-inch wide, cut fast and clean.

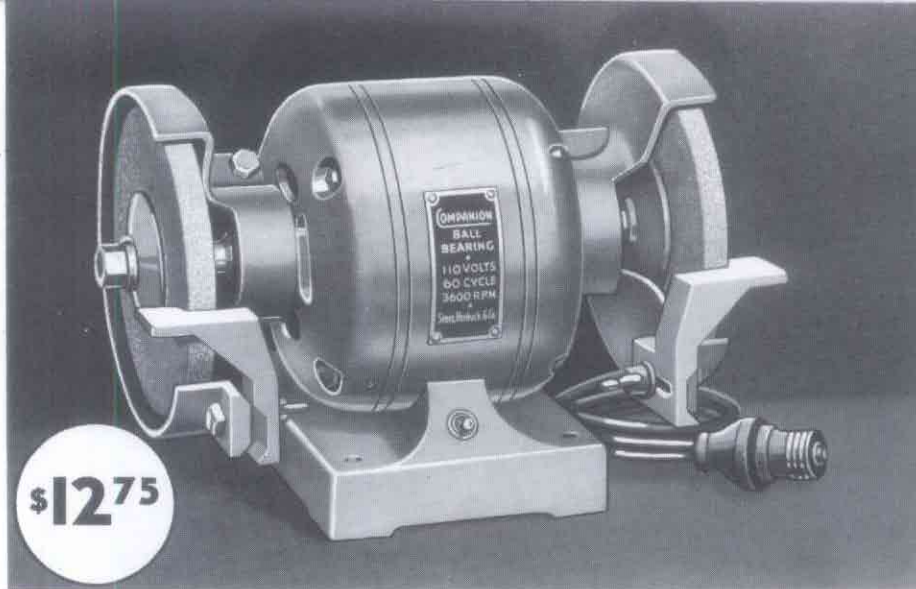

\$12.75

Has every feature of much higher priced grinders—removable wheel guards, adjustable tool rests, built-in toggle switch, big, husky 3450 R.P.M. 110-120-volt 60-cycle A.C. motor. The finely balanced rotor revolves on fully enclosed ball bearings protected from abrasive dust. Large, sturdy wheel collars maintain wheel alignment and meet all safety codes. Comes complete with one coarse and one fine grinding wheel, 6-ft. cord and attachment plug, ready to use. Shipping weight, 41 pounds.

Easy Terms!  
ON ORDERS OF  
120 OR MORE  
SEE INSIDE  
FRONT COVER

99 P 2605 ..... \$12.75

# KENMORE HEAVY DUTY 1/3 H. P. GRINDER

We designed this grinder with the garage and shop in mind, and we have sold thousands of them for these uses. Also widely used on the farm and in the home, as well as in hundreds of factories throughout the land. It's a husky grinder you can depend on—and you can depend on the price. Quality like this usually sells for much more. The heavy duty ball bearings are enclosed and protected against abrasive dusts. Ball bearings run more freely, handle end thrust easily and save current. Large balanced wheel collars insure perfect wheel alignment, true running and smooth operation. Big, powerful 1/3-H.P. ball bearing motor runs cool and quiet, providing ample power. Has fast-cutting vitrified 7x3/4-inch coarse and fine abrasive wheels. Completely equipped with removable safety guards, adjustable tool rests, toggle switch, convenient handle for carrying, and 6 feet of rubber covered cord with plug.

Shipping weight, 62 lbs.

- Dynamically balanced rotor revolves on heavy duty ball bearings. These fine bearings are fully enclosed and protected against abrasive dust.
- Heavy duty 1/3-H.P. 110-120-volt 60-cycle motor operates at 3450 R.P.M. and meets all Power Association requirements.
- Equipped with two finest quality fast cutting vitrified grinding wheels, 7x3/4 in. One coarse, one fine.
- Safety guards may be removed to permit use of buffer or scratch wheels. Designed to give full protection.
- Adjustable tool rests may be set as desired.
- Built-in toggle switch mounted in base.

99 P 2607 ..... \$19.95

Easy Terms!  
ON ORDERS OF  
120 OR MORE  
SEE INSIDE  
FRONT COVER

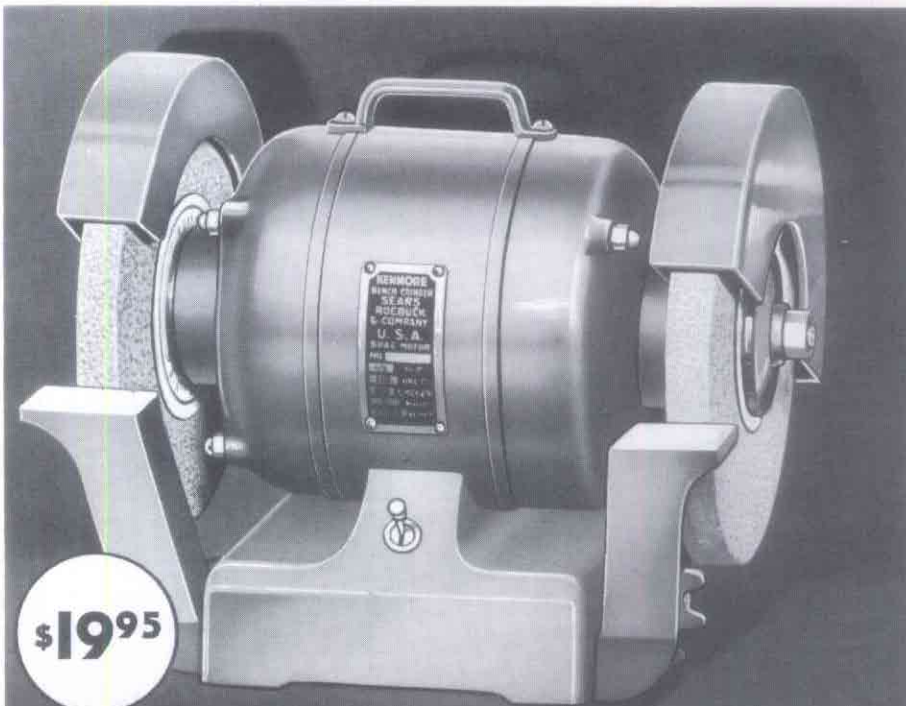

\$19.95



### Buffing Wheels

Best quality buffing wheels of 20 thicknesses of muslin carefully bleached and securely sewed. Will give excellent service. Have 1/2 in. center hole. Specify diameter.  
9 P 6490—4-in. Shpg. wt., 2 oz. Ea. . . 12c  
9 P 6490—6-in. Shpg. wt., 3 oz. Ea. . . 19c

### Buffing Compound

Used with buffing wheels to produce lustrous satiny finish on metal work. May also be used for natural wood finish. Also excellent for polishing catalin and other plastics. A superior grade that will satisfy you.  
Shpg. wt., 5 oz.  
9 P 2876 . . . 19c

### Tampico Brush

High quality fiber bristles. Fitted with sturdy balanced steel center. A real value at this price. 6-inch diameter, 1-inch face. Has 1/2-in. hole. Shpg. wt., 8 oz.  
9 P 6486 . . 49c

# CRAFTSMAN

REG. U. S. PAT. OFF.

## Motor Features:

- Extremely quiet running and highly efficient in operation.
- Meet all A. I. E. E., N. E. M. A., and Central Station requirements.
- Highest quality oversize phosphor bronze bearings.
- High Starting torque; extremely low starting current.
- Equipped with wool yarn filtered oiling system.
- Will run continuously under rated load without overheating.
- Economical of current under all load conditions.



**\$12<sup>75</sup>**  
1/4-H. P.

# CRAFTSMAN

REG. U. S. PAT. OFF.

## Repulsion-Induction MOTORS

### Guaranteed for Full 5 Years of Service

Built to the most exacting specifications in the electric motor industry by manufacturers with a world-wide reputation for quality. Because Sears are not only the world's largest distributors of power tools but also the largest dealers in fractional horse power motors sold at retail, you have a right to expect not only biggest value when you buy motors from us, but also the highest quality obtainable. And you get both! **CRAFTSMAN Motors** are popular all over America! They meet all A.I.E.E., N.E.M.A. and Central Station requirements. They operate with extraordinary efficiency, are very economical of current, start heavy loads and are built to last for many years. Rotors are in perfect balance, insuring smooth, quiet operation. Lubrication is by dependable wool yarn oiling, supplying a constant bath of filtered oil to the bearings at all times. Beautifully finished and full chromium trimmed. Beautiful, powerful, durable, money saving motors.

The high starting torque of these motors, their quiet, vibrationless operation and their speed of 1750 R.P.M. make them ideal for power tool use or for any job requiring a dependable source of trouble-free power at the snap of a switch!

Sizes from 1/4 to 1 1/2 H.P. are wound for 110-220 volt, 60 cycle, single phase current and are of the repulsion-induction type. Sizes from 2 H.P. and up are for use on 220-440 volt, 60 cycle, polyphase current and are of the squirrel cage type. We also can supply 2 H.P. and larger sizes in single phase repulsion-induction type at slightly higher prices. Write for prices. 2, 3 and 5-H.P. motors shipped prepaid from factory in New York City. Smaller sizes shipped from stock, not prepaid.

**Easy Terms!** ON ORDERS OF \$20 OR MORE SEE INSIDE FRONT COVER

#### Repulsion—Induction Motors

H.P.	Shpg. Wt.	Base Mounting	Size Shaft, In.	Catalog Number	Cash Price
1/4	32 lbs.	3 1/2 x 6 in.	5/8	99 P 5621	\$12.75
1/2	37 lbs.	3 3/4 x 6 in.	5/8	99 P 5622	17.50
3/4	66 lbs.	3 3/4 x 7 1/2 in.	3/4	99 PM 5623	22.50
1	72 lbs.	4 3/4 x 7 1/2 in.	3/4	99 PM 5624	29.95
1 1/2	76 lbs.	5 3/4 x 7 1/2 in.	3/4	99 PM 5625	39.90
2	141 lbs.	6 3/4 x 9 in.	1	99 PM 5626	48.50

#### Polyphase Current Motors

2	162 lbs.	7 1/2 x 9 in.	1	99 PM 5627	\$49.50
3	167 lbs.	7 1/2 x 9 in.	1	99 PM 5628	57.50
5	340 lbs.	11 x 12 3/4 in.	1 1/4	99 PM 5629	69.50

#### CRAFTSMAN Heavy Duty Ball Bearing Motor

1/2 H. P., for 110 or 220 Volt

A leading member of the CRAFTSMAN line—quality, guarantee, all the fine points of the motors above. In addition—**double drive shaft** and **precision ball bearings** permit this fine motor to be used in any position. The finest driving power for any tool. Shipping weight, 62 pounds.

99 PM 5619 . . . . . \$25.75

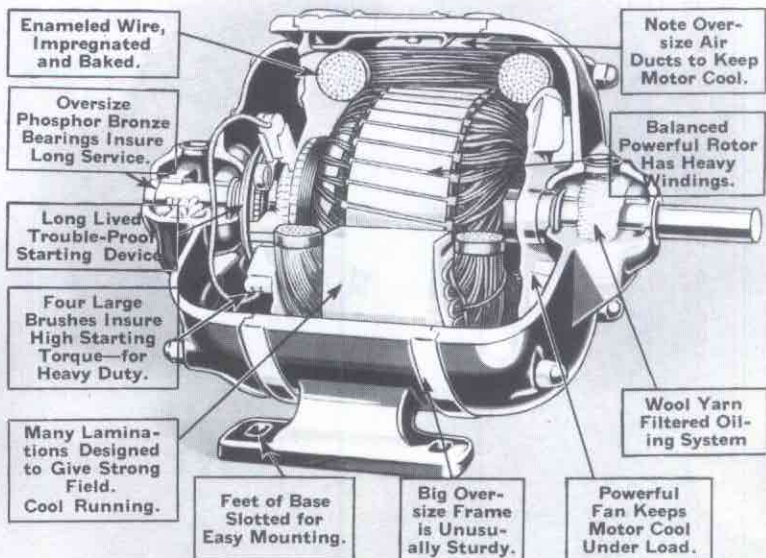

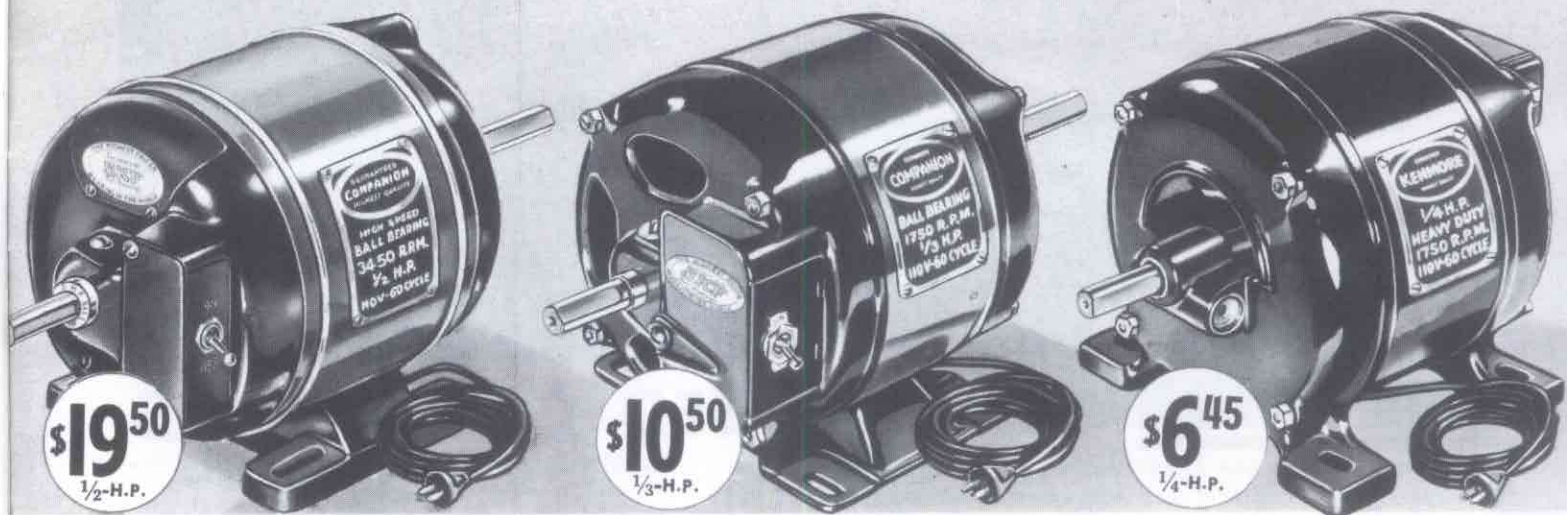

# HIGHEST QUALITY GUARANTEED!

## COMPANION Motors

- Guaranteed 5 years.
- Double drive shaft.
- Ball bearing equipped.
- Convenient toggle switch for starting or stopping.
- Plenty of reserve power.

# COMPANION

## Ball Bearing Motors

If you want a heavy, rugged, ball bearing motor of high quality at lowest possible cost, select the COMPANION. It will operate drill presses, grinders, bench saws, lathes, planers and other power tools. Heavy shaft turned down to 1/2-inch at ends to accommodate all standard accessories. Forced draft cooling—and needs almost no attention beyond a twice-a-year oiling. Base holes measure 3 3/4 in. across and 5 in. from brace to brace. Complete with 10 feet of rubber covered cord and plug. For 110-120 volt, 60 cycle A.C.

- 99 P 5606—1/4 H.P. Shipping weight, 25 pounds. . . . . \$ 7.95
- 99 P 5607—1/3 H.P. Shipping weight, 29 pounds. . . . . \$10.50
- 99 P 5608—1/2 H.P. Repulsion-Induction Type. For high speed power tools and general use. Speed, 3450 R.P.M. Shipping weight, 33 pounds. . . . . \$19.50

On Special order we can supply a high speed Repulsion-Induction 3/4-H.P. motor for use on high speed tools—similar to our 99 P 5608 1/2-H.P. high speed electric motor listed above. For 110 volt, 60 cycle A.C. only. Write for further information.



## Starting and Reversing Switch

- Toggle switch and reverse lever prevent accidental reversal of motor when in use.
- Furnished with 10 ft. of tested cord. Permits operator to place switch in most convenient location.
- Heavy arc-proof contacts.

**\$2.95** Designed to mount on tool in any convenient position. Has heavy arc-proof contacts and sturdy case equipped with toggle switch and reverse lever. When used with your shaper you can get double the number of patterns from your present set of cutters simply by inverting cutters and reversing rotation of shaper spindle! Also essential for grinding operations on screw cutting lathes. For all motors on this page except special 3/4-H.P. 3450 R.P.M., and 1/2-H.P. No. 99 P 5608 Repulsion-Induction motor. These may be reversed by shifting the position of their brushes. Shipping weight, 2 pounds.

9 P 2626 . . . . . \$2.95

## KENMORE Motors

- Guaranteed 3 years.
- Extra heavy bronze bearings.
- Wool yarn oiling insures constant filtered lubrication and long life.
- Splash-proof end plates and moisture-proof windings. Fan cooled.

# KENMORE

## Bronze Bearing Motors

Designed for light shop tools, washing machines and other uses where high starting torque is not required. Heavy 3/8-in. tool steel shaft turned down to 1/2 in. at pulley end to accommodate standard accessories. Rotors are accurately and individually balanced. Heavy bronze bearings insure long, trouble-free service. Operating speed, 1750 R.P.M. We do not believe you will find a bigger QUALITY motor value on the market than the KENMORE. For 110-120 volt, 60 cycle A.C.

Shipping weight: 1/4-H.P., 27 pounds; 1/2-H.P., 32 pounds.

- 99 P 5601—1/4 H.P. with cord . . . . . \$6.45
- 99 P 5602—1/2 H.P. with cord . . . . . 8.35

## KENMORE 1/4 H.P. D.C. Motors

- 99 P 5615—32 volt, with cord . . . . . \$14.75
- 99 P 5616—110 volt, with cord . . . . . 14.75

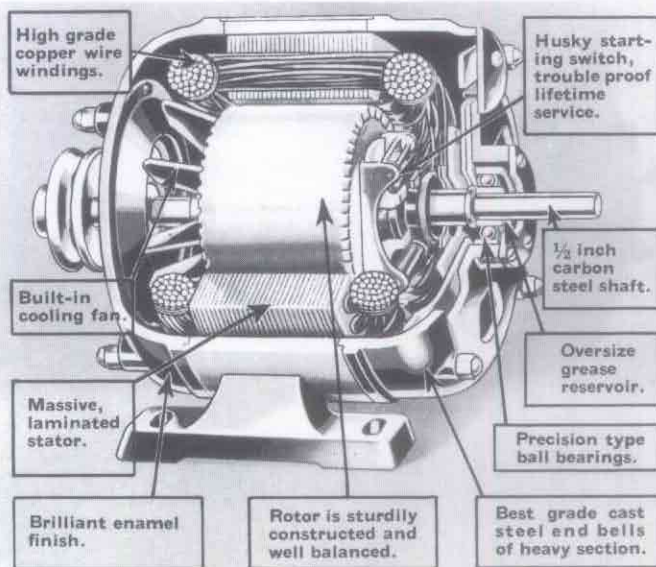

**Easy Terms**  
ON ORDERS OF  
100 OR MORE  
SEE INSIDE  
FRONT COVER



# COMPANION VULCANIZED CORD BELTS

COMPANION Vulcanized Cord Belts are longer-wearing . . . truer running . . . because of their heavy cord construction. They are extra-sturdy, cushioned in tough, cured rubber, with the close woven cord and vulcanized fabric. Properly shaped to run true and molded so the belt section is uniform throughout, they are unusually long-wearing. Belts of superior quality. Their side surfaces have the correct slant that insures maximum pulling power with a minimum amount of frictional loss between belt and pulley. When you buy COMPANION vee belts you get the most for your money!

Cat. No.	Length	Width	Shpg. Wt.	Price Ea.
9 P 2750	20 inches	3/4 inch	3 oz.	25c
9 P 2751	24 inches	3/4 inch	3 oz.	27c
9 P 2752	30 inches	3/4 inch	4 oz.	30c
9 P 2753	36 inches	3/4 inch	4 oz.	35c
9 P 2754	42 inches	3/4 inch	4 oz.	40c
9 P 2758	28 inches	1/2 inch	5 oz.	29c
9 P 2759	32 inches	1/2 inch	4 oz.	30c
9 P 2760	34 inches	1/2 inch	6 oz.	35c
9 P 2761	36 inches	1/2 inch	6 oz.	39c
9 P 2762	38 inches	1/2 inch	6 oz.	42c
9 P 2763	42 inches	1/2 inch	7 oz.	42c
9 P 2764	48 inches	1/2 inch	7 oz.	45c
9 P 2765	54 inches	1/2 inch	7 oz.	55c
9 P 2766	58 inches	1/2 inch	8 oz.	60c
9 P 2767	66 inches	1/2 inch	9 oz.	67c

1. Heavy cords at pitch line.
2. Tough cord wrapper.
3. Uniform section accurately molded.
4. Special cushioning insures flexibility.

Easy Terms! ON ORDERS OF \$20 OR MORE SEE INSIDE FRONT COVER

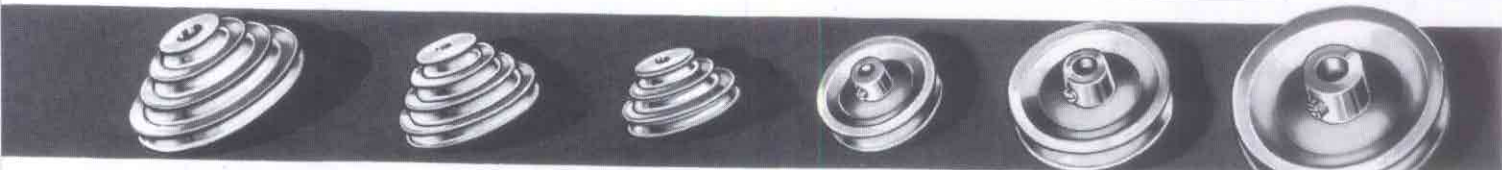

## VEE BELT PULLEYS FOR POWER TOOL USE

### Scientifically Designed Cone Pulleys

Perfectly balanced at all speeds, these pulleys will give long, smooth running service. Special belt groove construction insures great pulling power and much longer belt life. Fit 3/8 and 1/2-inch belts. **State bore.**

No.	Size	Steps	Bore	Diam., Step	Shpg. Wt.	Each
9 P 2279	4 in.	4	1/2, 3/4 or 5/8 in.	4 in., 3 3/4 in., 2 3/4 in.	2 in. 1 lb. 10 oz.	50c
9 P 2279	5 in.	4	1/2, 3/4 or 5/8 in.	5 in., 4 in., 3 in., 2 in.	1 lb. 14 oz.	65c
9 P 2280	3 3/8 in.	3	1/2 or 3/4 in.	3 3/8 in., 2 3/4 in., 2 in.	1 lb.	50c

### Highest Quality Vee Belt Pulleys

Made of highest quality alloy, light and long wearing. Strong flanges and hub with heavy set screw. Grooves accommodate 3/8 or 1/2 in. wide "V" belts. Beautiful aluminum finish. **Specify bore or shaft diameter.**

Number	Diam.	Bore	Shpg. Wt.	Each
9 P 2800	1 1/2 in.	1/2 in. only	3 oz.	17c
9 P 2801	2 in.	1/2 or 3/4 inch	5 oz.	20c
9 P 2802	2 1/2 in.	1/2, 3/4 or 5/8 inch	6 oz.	20c
9 P 2803	3 in.	1/2, 3/4 or 5/8 inch	7 oz.	23c
9 P 2804	4 in.	1/2, 3/4 or 5/8 inch	10 oz.	26c
9 P 2805	5 in.	1/2, 3/4 or 5/8 inch	15 oz.	32c
9 P 2806	6 1/2 in.	1/2, 3/4 or 5/8 inch	1 lb. 6 oz.	40c

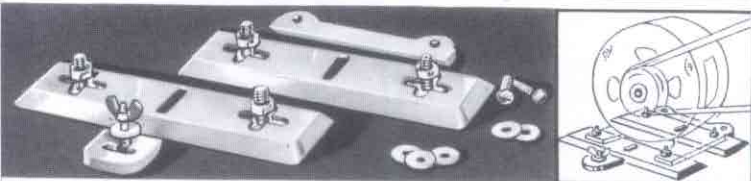

### Improved Adjustable Motor Rails

The final answer, we believe, to the motor-mounting problem! Low in cost . . . easy to install . . . instantly adjusted . . . wonderfully flexible! Simply fasten rails to base of motor, attach clips to bench top as shown above, at right. A turn of the wing nut on clip grips motor rails tightly when belt tension is just the way you want it. Loosen wing nut and motor with attached rails slides out for other positions, for use on other machines behind which similar clips have been mounted to receive the motor with rails. Beveled edges on rails and clips do the trick. Complete with necessary bolts, etc.

- 9 P 2280—Motor Rails complete as shown. Shipping weight, 1 pound 12 ounces. **65c**
- 9 P 2281—Extra Motor Rail Clips. Shipping weight, 9 ounces. Per Pair. **20c**

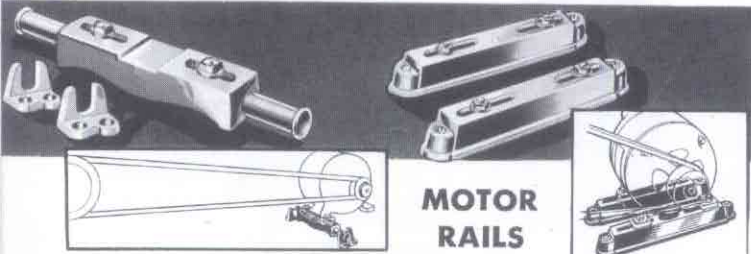

### MOTOR RAILS

**Floating** These floating type motor rails actually double or triple the utility of your motor . . . permit it to be used on almost any power tool in your shop! Keeps belt at proper tension automatically. Just equip one motor of proper size with these floating rails. Then buy additional motor rail clips for each tool, thus providing individual motor drive with only one motor needed! Especially recommended for use with bench saws.

- 9 P 2275—Floating Motor Rail and one pair clips. Shpg. wt., 2 lbs. **50c**
- 9 P 2277—Floating Motor Rail Clips. Shpg. wt., 8 oz. Per pair. **20c**

**Adjustable** It's easy to make belt adjustments when your motor is mounted on adjustable motor rails! Merely loosen bolts holding motor to rails and slide motor to proper position to get belt tension exactly right. Then tighten bolts. Motor stays put! Strongly constructed of cast iron. Nicely finished. Shpg. wt., 3 lbs. **9 P 2279 Per Pair. 50c**

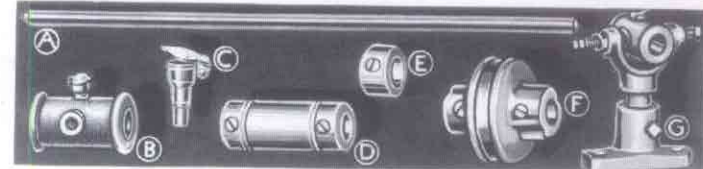

### Line Shaft, Hangers and Accessories

Accurately machined and finely finished parts of extremely high quality. The sturdy drop forged hangers have long wearing bronze bushings.

Catalog No.	Description	Shpg. Wt.	Each
(A) 9 P 2833	1/2 in. x 24 in. Steel Shaft	1 lb. 15 oz.	\$0.23
9 P 2834	1/2 in. x 48 in. Steel Shaft	1 lb. 15 oz.	.45
(B) 9 P 2822	Bronze Bushed Bearing (For 1/2-in. Shaft)	4 oz.	.25
(C) 9 P 2820	Wick Oil Cups	1 oz.	.05
(D) 9 P 2839	1/2 in. Rigid Coupling	5 oz.	.19
(E) 9 P 2824	1/2 in. Line Shaft Collar	2 oz.	.09
(F) 9 P 2840	Flexible Coupling (Specify 1/2, 3/4 or 5/8 in.)	12 oz.	.25
9 P 2828	1/2-inch Bronze Bushed Shaft Hanger	1 lb. 8 oz.	.89
9 P 2835	3/4 in. x 48 in. Steel Shaft	8 lbs. 8 oz.	.89
9 P 2829	3/4-inch Bronze Bushed Shaft Hanger	1 lb. 14 oz.	1.19
9 P 2825	3/4-in. Line Shaft Collar	3 oz.	.15



### Hollow Head Set Screws

To take the place of ordinary set screws on machines. The tremendous pressure exerted by wrench prevents screw from loosening. Made of chrome molybdenum steel. **State size.**

- 9 P 2811—Hollow Set Screw. Shpg. wt., 2 oz. 1/4-in. **5c**
- 3/8-in. **5c**
- 1/2-in. **5c**
- 9 P 2813—Wrench. Shipping weight, 1 oz. For 1/4-in. set screw. **5c**
- For 3/8-in. set screw. **5c**
- For 1/2-in. set screw. **5c**

### Round Belt Pulleys

Made for use with 1/4 and 3/8-in. round belts.

- 9 P 2782—1 3/4 x 2 1/8 in. 2-speed pulley. 1/2-in. bore. Shpg. wt., 4 oz. **35c**
- 9 P 2783—2 1/8 in. diameter, 1/2-in. bore double drive pulley. Shipping weight, 6 oz. **35c**
- 9 P 2781—Two-step. 1 1/8 and 1 3/4 in. Shpg. wt., 3 oz. **25c**

### Best Quality Round Belts

A fine grade of leather tanned to make it the toughest and strongest. Diameter, 1/2-in. Shipping weight, 4 ounces. **9 P 2844 Per ft. . . . . 7c**

**Belt Hooks for Round Belts**

- 9 P 2847—Belt Hooks for Round Belts. Shipping weight, 1 ounce. Dozen in a package. **5c**

# CRAFTSMAN

REG. U. S. PAT. OFF.

## Ball Bearing Heavy Duty Drill

- Dynamically balanced Westinghouse heavy duty 105-120-Volt universal motor.
- Armature and chuck spindles run on high quality oversize ball bearings, sealed in oil.
- Fitted with genuine Jacobs key chuck.
- Heavy double pole trigger switch is equipped with continuous action catch.
- Spindle, gear and pinion are chrome nickel steel, accurately made and heat treated for great strength and long life.

This heavy duty drill was designed so that it would have plenty of surplus power. As a result it will handle every conceivable drilling job with ease. We guarantee it will not stall when used with maximum size drill specified below. Beautifully made, with sturdy aluminum case and handle.

The genuine Westinghouse universal motor operates on A.C. or D.C. current, 105-120 volts. Full load wattage, 350. With arbor 9 P 2593, illustrated at right, you can use grinding, buffing and polishing wheels. Complete with heavy high grade Jacobs key chuck, and 10-ft. rubber covered cord and plug. Over all length, 13 1/2 inches.



**\$29<sup>95</sup>**  
1/4-in.

Cat. No.	Size Drill	No Load Speed	Shpg. Wt.	Price
99 P 2580	1/4 in.	2,000 R.P.M.	10 lbs.	\$29.95
99 P 2581	3/16 in.	1,500 R.P.M.	10 lbs.	31.50
99 P 2582	5/16 in.	1,000 R.P.M.	10 lbs.	34.75

Easy Terms  
ON ORDERS OF  
\$20 OR MORE  
SEE INSIDE  
FRONT COVER

9 P 2593—1/4-Inch Grinding Arbor for use with electric drills (Do not use with wheels larger than 4-inch diameter). Shipping weight, 6 ounces.....**39c**  
9 P 6686—High Speed Drills. Highest quality, American made. 7 sizes. See page 13 for full description. Shipping weight, 6 oz.....**\$1.49**

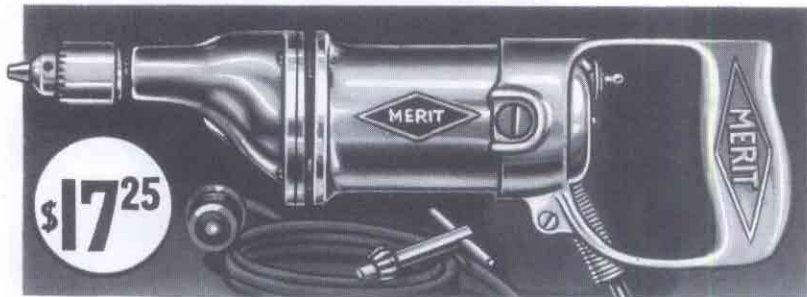

**\$17<sup>25</sup>**

## MERIT "PENCIL" DRILL

A Real Close Quarter Drill

A handy lightweight 1/4-in. drill of very rugged construction. Power is supplied by the dynamically balanced Westinghouse motor. The speed reducing gears are accurately made of the finest alloy steel heat treated for long life. Fitted with high quality ball thrust bearing and Jacobs chuck. Complete with handy toggle switch and 8-ft. rubber covered cord and plug. For use on 110-120 volt A.C. or D.C., with full load wattage of 125. No load speed, 1200 R.P.M. Over all length, 12 1/2 in. Removable handle permits it to be used in the most cramped quarters. Finely finished, accurately balanced; a beautiful tool, one that it is a joy to own. So well built that you will be proud of it for years. Shipping weight, 4 lbs. 8 oz.

Easy Terms  
ON ORDERS OF  
\$20 OR MORE  
SEE INSIDE  
FRONT COVER

9 P 2576.....**\$17.25**

# CRAFTSMAN

REG. U. S. PAT. OFF.

## Production Type Ball Bearing Drill

- MOTOR. Westinghouse ball bearing extra heavy duty universal type, dynamically balanced.
- SPINDLE. Highest quality alloy steel, runs on heavy duty ball bearings sealed in oil.
- ARMATURE SHAFT. Runs on oil sealed ball bearings.
- Extremely high torque, supplied through accurately made heat treated triple reduction gears.
- Equipped with genuine Jacobs chuck.
- Heavy double pole switch equipped with continuous action catch.

Built for the heaviest production work, this drill will give years of trouble-free service. We have sold large numbers of them for use in auto repair shops, factories and mills. When used with maximum drill size specified this drill will not stall on any job. It is powered by an extra heavy duty Westinghouse motor and fitted with triple reduction gears to produce exceptionally high torque. Operates on any 110-120-volt current, A.C. or D.C. Full load wattage, 510. Forced ventilation insures a cool operation. Complete with genuine Jacobs chuck and 10-ft. heavy rubber covered cord and plug.

Cat. No.	Size Drill	No Load Speed	Shpg. Wt.	Price
99 P 25585	1/2 in.	750 R.P.M.	23 lbs.	\$46.50
99 P 25586	3/4 in.	525 R.P.M.	23 lbs.	52.50
99 P 25587	3/4 in.	475 R.P.M.	23 lbs.	56.50

Easy Terms on orders of \$20.00 or more. See inside front cover.

### Circular Hole Saw

For use with 1/2-in. drills or larger. Made of high speed steel. Complete with mandrel.

Size, in. . .	3/4	1	1 1/4	1 1/2	2	2 1/2
Shpg. wt. . .	4 oz.	6 oz.	8 oz.	11 oz.	13 oz.	1 lb.
9 P 2698	\$2.25	\$2.25	\$2.35	\$2.35	\$2.65	\$2.85

### Saw Blade Only for Circular Hole Saw

Size, in. . .	3/4	1	1 1/4	1 1/2	2	2 1/2
Shpg. wt. . .	4 oz.	6 oz.	10 oz.	12 oz.	14 oz.	1 lb.
9 P 2697	\$1.25	\$1.25	\$1.45	\$1.45	\$1.65	\$1.95



**\$46<sup>50</sup>**  
1/2-in.



# COMPANION

## New Type Sturdy Work Bench

A work bench bargain if there ever was one . . . made possible by Sears tremendous buying power! Think of being able to buy a large and sturdy wood work bench for so little! Every piece of lumber is carefully dressed, then accurately milled and fitted. The top is 1½ inches thick, which will give you an idea of the rugged quality of this bench. Bench is provided with drawer measuring 20¾x17½ inches, 3½ inches deep. Note the large size, extra sturdy top and legs. The 174-lb. net weight.



**\$7<sup>50</sup>**

We also include bench screw for vise and heavy turned wood handle. We ship bench to you knocked down to save freight and make this low price possible. It is easily and quickly assembled when you receive it. We include complete instructions for putting bench together. All you need is a hammer and nails. Makes an ideal bench for power tools, or may be used for other woodworking purposes.

Size of top; 2 feet x 6 feet. Height, 32 inches. This is a big, heavy, sturdy bench. Its net weight is 174 lbs. A real value! Shipping weight, 175 pounds.

99 PM 2721 . . . . . \$7.50

99 PM 2722—Set of 4 sturdy U-section steel work bench legs for use in building your own work bench. Height, 31½ in.; width, 21 in. Shpg. wt., 34 lbs. . . . . \$4.95

Easy Terms! ON ORDERS OF \$20 OR MORE SEE INSIDE FRONT COVER



**\$1<sup>45</sup>**

### Tool Light

One of the handiest accessories ever devised for use with power tools. We have perfected a light which not only may be clamped on a tool in a jiffy, but that will stay "put." The flexible neck enables light to be brought right down to the work, extra large reflector keeps it out of your eyes. Two or three of these in a well-equipped shop will save your eyesight and do away with overhead lights that cast shadows on your work. Length of neck, 15 inches. Complete with push switch in socket, cord and plug. Shpg. wt., 2 lbs.

9 P 2264 . . . . . \$1.45



**\$1<sup>25</sup>**  
SET

### Workshop Manuals

A fine set of four 72-page books with numerous illustrations in halftone and pen and ink. A total of 288 pages, with sections on The Lathe; The Drill Press; The Band Saw and Jig Saw; The Bench Saw, Jointer and Shaper. Covers their construction, care and operation. A valuable collection of information. Shipping weight, set, 2 lbs.

- 9 P 2919—Set of 4 books . . . . . \$1.25
  - 9 P 2920—The Lathe . . . . . 40c
  - 9 P 2921—The Drill Press . . . . . 40c
  - 9 P 2922—The Band Saw and Jig Saw . . . . . 40c
  - 9 P 2923—The Bench Saw, Jointer and Shaper . . . . . 40c
- Shipping weight, each, 7 ounces.



### CRAFTSMAN Apron

**39c** Made from excellent quality heavy white canvas with high front to protect the shirt. Extra long, full 42 inches, so as to come well below knees. Easy to put on; it saves many times its cost in clothes.

Decorated with CRAFTSMAN trade mark on front. You'll find others ask much more for aprons not so good as this!

Shipping weight, 9 ounces.  
9 P 2950 . . . . . 39c

## MAKE YOUR OWN SAW HORSE!

**78c**  
And Up

### COMPANION Metal Joints

- Made of strong malleable iron.
- Rustproofed. Will last a lifetime.
- No nails, screws or bolts needed.
- Easily put together with a hammer. No nailing.
- May be used again and again.

Make your own saw horse . . . in a jiffy . . . with COMPANION joints! A pair of these husky malleable iron joints, some 2x4 lumber and a hammer are all you need. NO NAILS—BOLTS OR SCREWS—NO BEVELING OR JOINTING OF LUMBER. Horses built with COMPANION joints are much stronger and more rigid. Provided with locktight grippers that prevent side sway, spreading or wobbling. Every shop or home needs one or more sets of these strong, durable saw horse joints. Add them to your order for other tools!

9 P 2896—COMPANION joints for 1x3 lumber, per set of 2. Shipping weight, 4 lbs. 6 oz. . . . . 78c

9 P 2897—COMPANION joints for 2x4 lumber, per set of 2. Shipping weight, 10 pounds. . . . . \$1.40

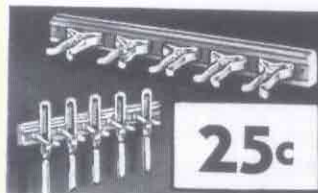

### Adjustable Tension Tool Clips

Safely in place on these clips, your tools will remain bright and sharp. Tools rolling around a work bench soon lose their sharp edges.

Made of the finest spring steel these clips are adjustable in grip tension to accommodate tools from the smallest to the largest. Mounted in groups of five on a nicely finished wood strip. Shipping weight, 10 ounces.

9 P 2865—5 mounted tool clips, without chisels. . . . . 25c



### 19c Easy-to-Use Blueprints

EACH Clear, easy to use. All necessary information: list of materials, sketch of finished job, details of joints and directions for finishing. (1) Priscilla Sewing Cabinet, (2) High Back Lawn Chair, (3) Colonial Spinnet Desk, (4) Drop Leaf Table, (5) Garden Trellis, (6) Old West Silhouettes, (7) Work Bench, (8) Hanging Book Rack, (9) Cobbler's Bench Table Lamp, and (10) Cedar Lined Chest. State plan wanted. Shipping weight, each, 3 oz.

9 P 2900—Each . . . . . 19c



# COMPANION

## All-Metal Heavy Duty Machine Stand

An extra heavy, rigid machine stand developed expressly for use with power tools. Our comparisons lead us to believe this is one of the finest machine stands being built today. Its appearance in the home workshop or industrial establishment ushers in an era of efficiency and order . . . of cleanliness. Beautifully made of steel throughout and constructed in such a manner that all resonance or "hum" has been brought to a minimum. Top and shelf are secured to legs at their corners with unusual rigidity. Legs are drilled with six holes, for varying height of steel tool or motor shelf. Tops are finished in a lustrous black, the legs in royal blue. Packed flat for shipping, very easily assembled. Sold at a world beating price, the quality is unquestionable. Order yours today and save at Sears!



99 PM 2719—Width, 10 in.; length, 21 in.; height, 29 in. For all band saws. Shipping weight, 32 pounds \$4.25  
 99 PM 2719—Width, 10 in.; length, 21 in.; height, 31 in. For other power tools, except Jig Saw 99 PM 2262 listed on page 9. Shipping weight, 33 pounds. \$4.25  
 99 PM 2719—Width, 10 in.; length, 34 in.; height, 31 inches. For Jig Saw 99 PM 2262, page 9. Shipping wt., 39 lbs. \$4.95

Easy Terms  
 ON ORDERS OF \$20 OR MORE - SEE INSIDE FRONT COVER

## Perfect Balance, Proper Tension—Circular Saws



### CRAFTSMAN and FULTON Circular Saws

CRAFTSMAN saws are made of special analysis saw steel, carefully heat treated and hardened. They are given the proper tension which insures easy vibrationless operation, and finished to a glass-like smoothness. We believe CRAFTSMAN saws are the finest obtainable.

FULTON saws are made of spring tempered, hardened saw steel. An outstanding bargain at Sears low price. Accurately set and filed, ready for use. We stock center hole sizes listed below but any size up to 2 inches supplied without extra cost. State size saw and center hole wanted.

Diameter, Inches	Gauge	Center Hole, In.	Revolutions Per Minute	Shpg. Wt.	CRAFTSMAN		FULTON	
					Cut-off	Rip	Cut-off	Rip
6	18	1/2 or 3/8	4000	8 oz.	9 P 4927	9 P 4928	9 P 4923	9 P 4924
7	18	1/2 or 3/8	3500	12 oz.	\$1.59	\$1.59	\$0.89	\$0.89
8	18	1/2 or 3/8	3500	14 oz.	2.15	2.15	1.35	1.35
10	16	3/4 or 1	3500	1 lb. 10 oz.	2.69	2.69	1.65	1.65

### Combination Saws

Handiest of all circular saws because they are specially designed for cross cutting, ripping or mitering. They are constructed to cut fast, free and easy in all woods. FULTON flat ground and CRAFTSMAN plain tooth saws are filed and set ready for use. CRAFTSMAN hollow ground saws have ample clearance. Cut smooth and run without set.

State size saw and center hole wanted.

CRAFTSMAN Comb. Plain Tooth	CRAFTSMAN Comb. Hollow Ground	FULTON Comb. Flat Ground
9 P 4936	9 P 4939	9 P 4938
\$1.00	\$2.45	\$1.00
1.45	3.25	1.45
.....	4.25	1.85



#### Face Plates

For all CRAFTSMAN and COMPANION lathes with 3/8-in. spindles. Carefully machined and balanced.

(A) 9 P 2080—3-in. Shipping weight, 9 ounces. . . . .75c  
 (B) 9 P 2081—6-in. Shipping weight, 1 pound. . . . . \$1.00

#### Spur Center

For all CRAFTSMAN and COMPANION lathes with 3/8-in. spindles. Removable center. Shipping weight, 6 ounces.

9 P 2105. . . . .65c

#### Cup Center

Carefully made, hardened steel cup center for lathe stock of 1/2 in. Removable center pin. Fits any 3/8-in. spindle. Shipping weight, 6 ounces.

9 P 2102. . . . .65c

#### Work Arbor

Fits any 1/2 or 3/8-in. spindle. Has finely faced steel, collars for grinding or buffing wheel, and well made 3-jaw 1/2-inch chuck. State spindle size. Shipping weight, 1 pound 10 ounces.

9 P 2118. . . . .85c

#### 1/2-Inch CRAFTSMAN Drill Chuck and Arbor

Carefully made 3-jaw steel chuck with adapter, for all CRAFTSMAN lathes with 1/2-in. or 3/8-in. spindles. High grade, accurately ground. State spindle size. Shipping weight, 1 pound 6 ounces.

9 P 2140. . . . .95c

#### Work Arbor

Same as 9 P 2118, above, but without chuck. Has finely faced steel and collars to clamp grinding or buffing wheel. State spindle size. Shpg. wt., 15 oz.

9 P 2120. . . . .39c

#### 3-Jaw Chucks

A special development in a 3-jaw chuck with jaws held firmly in position by guides within the shell. Far superior to ordinary chucks. Fit 1/2-in. spindles.

(H) 9 P 2130—1/4-inch. Shipping weight, 5 ounces. . . . .23c

(I) 9 P 2132—1/2-inch. Shipping weight, 12 ounces. . . . .50c

(J) 9 P 2134—1/2-inch. Finely ground. Shipping weight, 1 pound. . . . .75c

#### (K) 4-Jaw Independent Chuck

4-in. capacity, reversible jaws. Well made, nicely machined. Fits any lathe with 3/8-inch spindle. Shpg. wt., 3 lbs. 12 oz.

9 P 2136. . . . . \$4.65

#### (L) Drum Sander

Accurately made. Complete with two sleeves and adapter. Fits 1/2-in. shaft. Shpg. wt., 1 lb. 2 oz.

9 P 2520. . . . .98c

9 P 2522—Sanding sleeve for above drum. Fine, medium or coarse. State grit wanted. Shipping weight, 2 ounces. . . . .10c

#### (M) Sanding Discs

Carefully machined and balanced, aluminum discs to be fitted with sandpaper. Fits only 3/8-in. spindle.

9 P 2153—6-in. Shipping wt., 1 lb. . . . \$1.00

9 P 2159—8-in. Shpg. wt., 1 lb. 8 oz. . . . \$1.50



**\$37<sup>50</sup>**

## COMMANDER Power Sprayer

Easy ON ORDERS OF  
Terms! '20 OR MORE  
SEE INSIDE  
FRONT COVER

- Sprays Everything: Lacquers, Oil and Cold Water Paints, Enamels, Varnishes, Insecticides, Disinfectants. Saves Time and Money.
- Heavy duty 2-ring wick oil compressor. Supplies clean, oil-free air.
- Pressure type gun with two air caps for round or fan spray.
- 1/4-H.P. 1750 R.P.M. heavy duty motor. Economical to operate.

One of the most complete low-priced Power Sprayers ever built. What's more it's a real PRODUCTION TYPE sprayer—the kind of machine that usually sells for from \$50 to \$65. With this sprayer you can handle any job, large or small, in less than half the time and with great economy. It sprays most any material that you can apply with a brush—does it better and more thoroughly. The complete outfit is mounted on a heavy steel base measuring 20x10 in. Motor operates on 110-120-volt, 60-cycle A.C. Comes complete with motor, pump, air chamber, 1-qt. aluminum paint cup on pressure type gun with 2 tips and 2 air caps, 15 ft. of high pressure hose and V-belt drive on castor-mounted base. Shpg. wt., 68 lbs.

99 PM 5635—Sprayer as illustrated.....\$37.50

99 P 5636—Spray Gun. With 2 fluid tips for light and heavy materials. Also fan and round spray caps. Shipping weight, 2 pounds 14 ounces....\$6.50

99 P 5632—Two-Gallon Galvanized Pressure Feed Tank. Complete with 15-ft. air hose and 12 1/2-ft. material hose. Shpg. wt., 15 lbs.....\$9.45

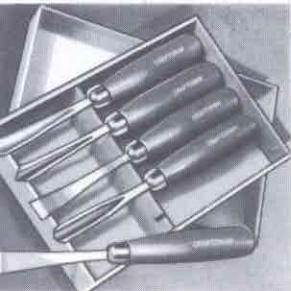

## CRAFTSMAN

### Wood Carving Tools

**\$1<sup>98</sup>** A set of five finely finished wood carving tools with 3 3/4-inch handles, 2 1/2-inch blades. With these tools you can make an infinite variety of wood carvings. The blades are forged from a fine quality of steel, heat treated with the utmost care to take and hold a razor keen edge.

The set includes one each of the following: 3/8-inch bent gouge, 3/8-inch bent chisel, 3/8-inch U tool, 5/16-inch straight chisel and a 1/2-inch veining tool.

99 P 2899—Complete set of above five tools, attractively boxed. Shpg. wt., 13 ounces. \$1.98



### Electric Glue Pot

**\$3<sup>39</sup>** Every shop should have an electric glue pot. Here's one that embodies the latest methods of design. Heating element is embedded in asbestos to insure maximum safety and long life. Thermostat automatically controls temperature... needs no adjusting. The old fashioned water pot has been eliminated, nothing to refill. Polished aluminum, with blue-enamelled gray iron frame, with stir wire, 6 feet of Underwriters' approved cord and non-breakable rubber plug. Capacity, 1 pint. For 60-cycle 110-120 volt alternating current (A.C.) only. Shipping weight, 6 pounds 8 ounces.

99 P 2893.....\$3.39

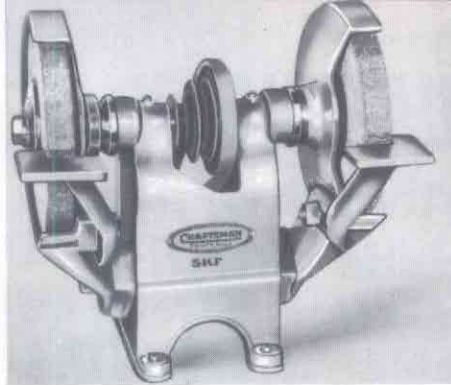

**\$7<sup>95</sup>**

Complete

Easily the finest of its kind. This precision built grinder has an unusually heavy and well machined mandrel, mounted on highest quality ball bearings. It is furnished complete with adjustable tool rests, wheel guards, 3-step cone pulley, and two high grade 6-inch x 3/4-inch grinding wheels, one coarse and one fine. The ball bearing shaft runs very freely and is particularly well designed to accommodate heavy grinding which imposes end thrust upon it. The heavy duty fully enclosed ball bearings are protected against abrasive dust to insure long life. The 3-step pulley permits the use of the correct grinding speed for the material being handled. Shpg. wt., 18 lbs.

99 P 2514—Companion Grinder complete as described above.....\$7.95

99 P 2515—Same as above but without wheels or guards; grinder head only. Shpg. wt., 14 lbs.....\$4.95

## CRAFTSMAN HEAVY DUTY GRINDER

Sealed  
Ball Bearings  
3 Speeds

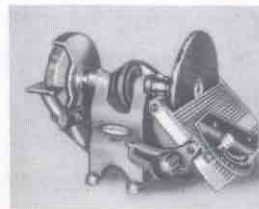

99 P 2613—Sanding Attachment, including high grade miter gauge, fits above grinder. Illustrated above. This attachment with the COMPANION Ball Bearing Grinder makes an ideal heavy duty disc sanding unit. For those who want the best. Shipping weight, 9 pounds.....\$3.95

## COMPANION ELECTRIC SPOT WELDER

- Plugs in like a lamp cord—no special wiring needed.
- Capacity: 2 pieces of 20-gauge (1/32 in. or lighter) soft steel, sheet iron, tin, or 1/8-in. wire.
- Consumes only a small amount of current and only at instant of use.
- Operates on 110-volt 60-cycle A.C. only. Can be furnished for 220-volt A.C. on special order.
- Equipped with safety fuse.

### FAST . . . PERMANENT ECONOMICAL

No shop is complete without a COMPANION Electric Spot Welder. With this handy little tool you can weld 20-gauge soft steel, tin, iron or 1/8-inch wire . . . No flux, acid or welding wire needed.

### Welds 20-Gauge Soft Steel Tin—Iron—1/8-in. Wire

The handiest tool you ever saw for quick repair jobs and for all-around light spot-welding! Not in any sense of the word a toy, yet not designed as a heavy production machine, this handy COMPANION Electric Spot Welder will turn out perfect welds with ease. With this machine you can make aquariums, bird houses, lamp shades, signs, toys, model-builders' knives, bird cages, etc. Complete with foot pedal.

99 P 2000—COMPANION Electric Spot Welder, complete, less stand. Shipping weight, 36 pounds.....\$22.95

99 P 2004—Butt Welding Attachment for welding wire, extension shanks on drills, etc. Not illustrated. Shpg. wt., 8 lbs. 2 oz.....\$6.75

99 P 2002—Steel Stand, drilled and fitted for above welder. Disassembled for shipping. Shpg. wt., 10 lbs.....\$3.15

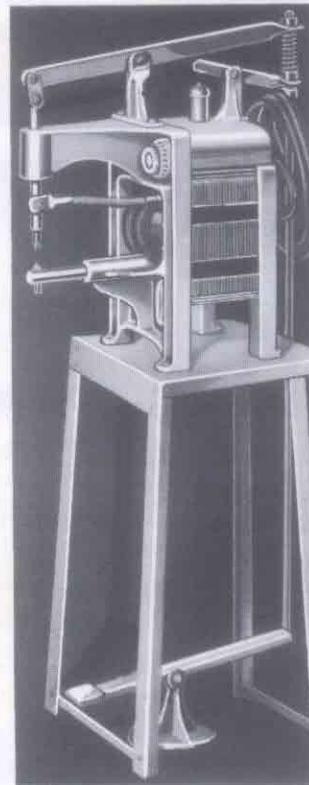

## Here are magazines you will enjoy

Big magazines filled from cover to cover with helpful information on how to make things and how to do things in and about the home.

Profusely illustrated with photographs and large scale working drawings. Every article is complete. Plans that anyone can read and details that permit no guessing. Every article built right in front of your eyes.

### Below you will find a partial list of subjects covered in recent issues

- |                         |                           |                               |
|-------------------------|---------------------------|-------------------------------|
| Rustic Furniture        | Doll House Furniture      | Miniature Grandfathers' Clock |
| A Model 40-Foot Cruiser | Castle for Toy Soldiers'  | Workshop Muffle Oven          |
| Pipe Rack               | Rustic Mail Box           | Window Screen Frames          |
| Aquarium                | Children's Breakfast Nook | Winter Fishing Shelter        |
| A 20-Foot Sailing Sloop | New England Sled          | Pirates' Treasure Chest       |
| Lawn Chairs             | Simple Ship's Lantern     | Fast 16-Foot Runabout         |
| Interesting Bird Houses | Early American Desk Box   | Novelty Windwheel             |
| Antique Sewing Table    | Four-Poster Bed           | Jig-Saw Circus Train          |
| Model of U.S.S. Niagara | 18th Century Secretary    | Roulette Wheel                |
| Butterfly Table         | Hempwhite Dining Table    | Book Binding                  |
| Well Designed Andirons  | Old "Shaker" Rocker       | Kitchen Table                 |
| Child's Kitchen Cabinet | Scroll Saw Novelties      | Coffee Table                  |
| Melodious Dinner Chimes | Double Deck Fireplace     | Surf Board                    |
| Novel Duck Lamp         | Boathouse                 | Fly Rod                       |

ON SALE EVERY MONTH AT SEARS RETAIL STORES

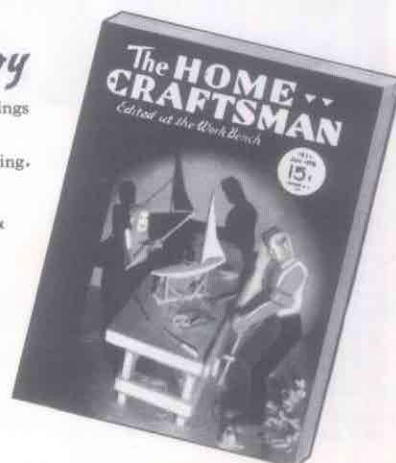

# The Biggest Workshop Value Ever Offered!

## COMPLETE POWER TOOL OUTFIT-

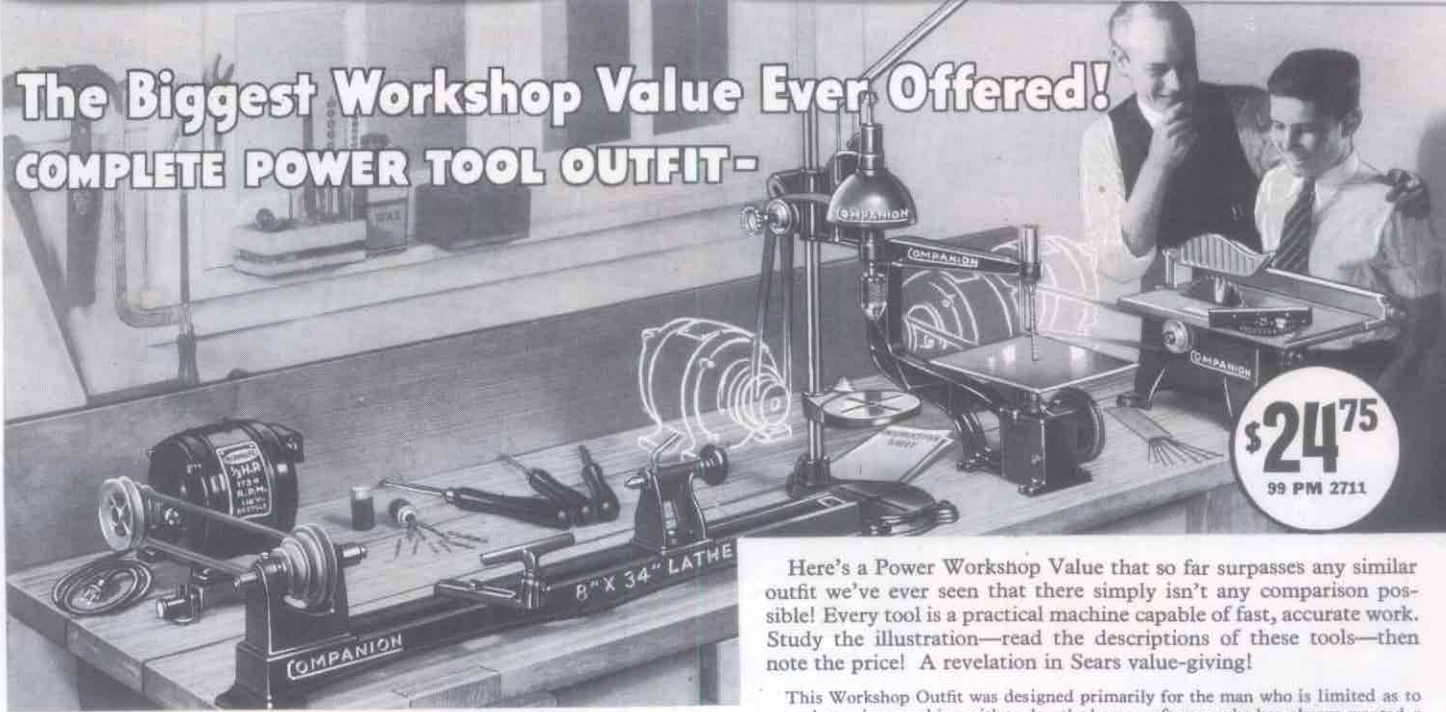

Here's a Power Workshop Value that so far surpasses any similar outfit we've ever seen that there simply isn't any comparison possible! Every tool is a practical machine capable of fast, accurate work. Study the illustration—read the descriptions of these tools—then note the price! A revelation in Sears value-giving!

This Workshop Outfit was designed primarily for the man who is limited as to space but enjoys working with tools—the home craftsman who has always wanted a good small shop—but felt the cost was prohibitive. Every piece of equipment in this shop is PRACTICAL, well made, of high quality materials, and is FULLY GUARANTEED. You can select this Workshop with complete certainty of satisfaction—and be confident that you got a real bargain!

Join the thousands of craftsmen—men in all walks of life—who are enjoying the thrill and satisfaction that comes from creating articles of utility and beauty with their own hands.

For Easy Terms See Inside Front Cover

Easy Terms ON ORDERS OF \$20 OR MORE SEE INSIDE FRONT COVER

	Shpg. Wt.	
99 PM 2711—Workshop less bench and motor	94 lbs.	\$24.75
99 PM 2712—Workshop less motor	269 lbs.	29.95
99 PM 2713—Workshop less bench	126 lbs.	32.50
99 PM 2714—Complete workshop	300 lbs.	38.50
99 PM 2226—COMPANION Bench Saw	27 lbs.	5.95
99 PM 2374—COMPANION Drill Press	18 lbs.	4.95
99 PM 2013—COMPANION Lathe	20 lbs.	4.95
9 P 2258—COMPANION Jig Saw	15 lbs.	4.95
9 P 2260—Set of 3 Chisels	2 lbs.	1.69
99 PM 2721—Work Bench	175 lbs.	7.50
99 PM 5602—KENMORE 1/4-H.P. Motor	32 lbs.	8.35
9 P 2788—3-Step Pulley	2 lbs.	.50
9 P 4081—Set of 9 Drills	4 oz.	.25
9 P 2695—Pkg. of 8 Jig Saw Blades	2 oz.	.19
9 P 2274—Motor Rail Set and 3 extra pair Clips	3 lbs.	1.10
9 P 2770—Set of 3 "V" belts	2 lbs.	1.15

WHAT THIS WORKSHOP INCLUDES. The complete Power Tool Workshop includes a sturdy 24x72-inch Work Bench, COMPANION 6-Inch Bench Saw with 10x12 3/4-inch table, COMPANION Drill Press with high grade 3/8-inch chuck, 8-inch COMPANION Lathe with 34-inch bed, COMPANION Jig Saw with 8x8-inch table that tilts to any angle up to 45°, husky KENMORE 1/4-H.P. Motor, Motor Base and four pairs of clips, three heavy cord "V" Belts, a set of 9 Twist Drills ranging in size from 1/16 to 3/16 inch, Package of 8 Jig Saw Blades, Complete Set of Instructions for set up, care and operation of shop, 3-step "V" Motor Pulley and Set of Three CRAFTSMAN Turning Chisels. Remember, when you buy the complete Workshop you get EVERYTHING needed to set up and operate the outfit. You don't have to buy a single additional item of equipment! After you have the Workshop set up you simply plug in the motor to your nearest lamp socket and you are ready to go to work!

We want to emphasize the fact that the tools in this outfit are NOT toys, but full size, practical tools that will give years of splendid service. If you enjoy wood-working—turning, carving, routing, jig sawing, and drilling—if you like to "make things" and want a sturdy, low-priced outfit for your home or shop, this is the one to buy!

An important feature of this workshop is the ease with which you can attach the motor to any of the tools. Motor rail clips are furnished so as to provide a pair for each tool. The motor is mounted on a base which fits into the clips furnished permitting it to be moved from one tool to another with the greatest ease. A device which represents a real advance in the mounting of motors. For those who do not wish to pay all cash we offer this workshop outfit on Sears regular Easy Terms, as explained on inside front cover.

## For those who want to select "a tool at a time"



### COMPANION 6-In. Bench Saw

A sturdy, well built saw that will do fast accurate work; cuts miter joints, cross cuts and rips. Has 10x12 3/4-inch table which may be tilted to any desired angle up to 45°. Bearings are auto-lubricated bronze type. Depth of cut, 1 1/2 in.

Complete with rip fence, miter gauge and approved guard.

Shipping weight, 27 pounds.  
99 PM 2226..... \$5.95



### COMPANION 10-In. Jig Saw

Note the sturdy "bridge truss" type frame used in building this saw—a feature found only in much higher priced tools. The action is finely balanced and enclosed in an oiltight case. 8x8-inch table may be tilted to any angle up to 45°. This saw uses plain or pin end blades. See page 7. Equipped with built-in sawdust blower.

Shipping weight, 15 pounds 12 ounces.  
9 P 2258..... \$4.95

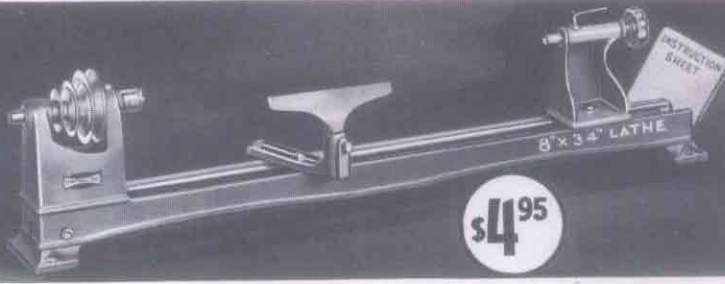

### COMPANION 8-Inch 3-Speed Lathe

Built for real service, this husky lathe will handle work up to 25 inches long and 8 inches in diameter. Has well braced 34-inch gray iron bed with smoothly finished ways, ball thrust bearing headstock and screw feed tailstock. Bearings are auto-lubricated type, accurately finished. Complete with spur and cup centers and 5-inch tool rest. Shipping weight, 20 pounds.

99 PM 2013..... \$4.95  
9 P 2214—Lathe sanding attachment complete with tilting table for use on above. Shipping weight, 6 lbs. 8 oz..... \$1.95

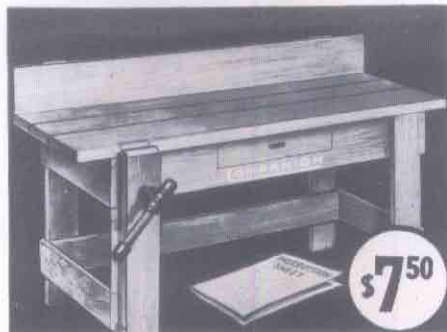

### COMPANION Work Bench

An unusually heavy, rugged work bench of select wood with all parts carefully finished and fitted. Plenty of space on its large 24x72-inch top for mounting all of the tools in the outfit shown above. Shipped knocked down, but very easily and quickly assembled by following the simple instructions sent with bench. Height, 32 inches. Complete with bench vise. The heaviest sturdiest work bench we have ever seen at anywhere near this price.

Shipping weight, 175 pounds.  
99 PM 2721..... \$7.50

### COMPANION Drill Press

You can handle a surprising amount of work on this sturdy drill press, and very rapidly, for it is built to perform all operations with ease. The over-size bearings are auto-lubricated bronze type, with large ball thrust bearing mounted in head. Adjustable drill head. Pulley fitted with safety guard. Complete with excellent quality 3/8-inch chuck. 1 3/4-inch spindle travel. Height, over all, 31 1/4 inches. All-in-all, a ruggedly built drill press that is remarkably low priced.

Shipping weight, 18 pounds.  
99 PM 2374..... \$4.95





**\$10<sup>95</sup>**  
Page 2



**\$21<sup>95</sup>**  
Page 3

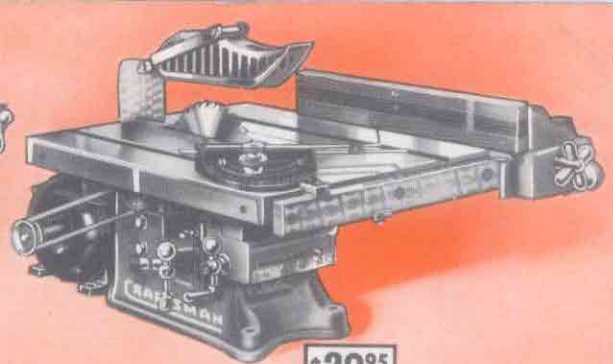

**\$29<sup>95</sup>**  
Page 5

**THE NATION'S HEADQUARTERS FOR HIGH QUALITY POWER TOOLS**

**CRAFTSMAN**  
REG. U.S. PAT. OFF.  
AND  
**COMPANION**  
**POWER TOOLS**

Set the Nation's Standard  
of Quality and Value

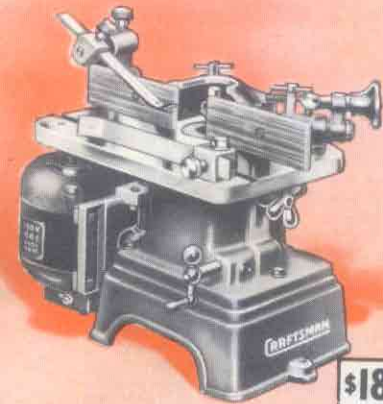

**\$18<sup>95</sup>**  
Page 12

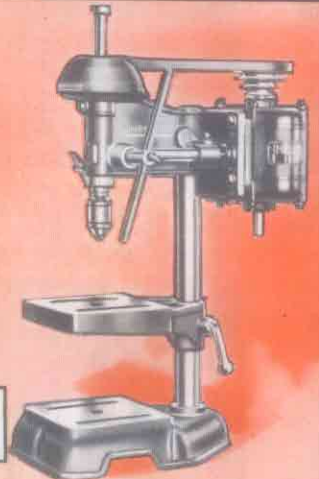

**\$13<sup>50</sup>**  
Page 13

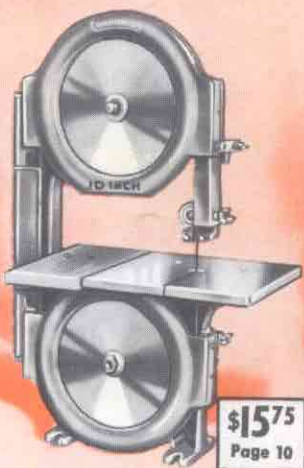

**\$15<sup>75</sup>**  
Page 10

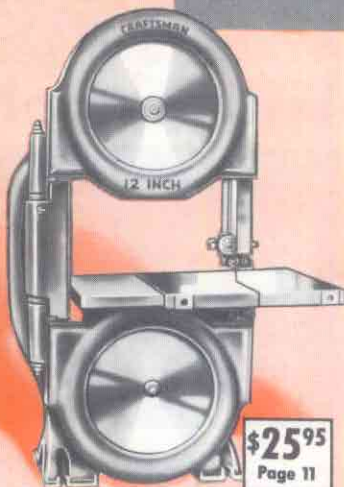

**\$25<sup>95</sup>**  
Page 11

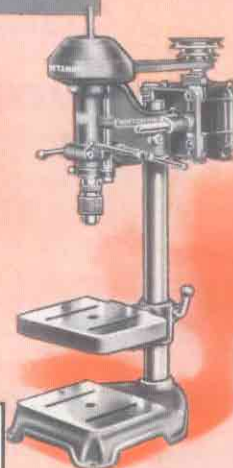

**\$23<sup>50</sup>**  
Page 15



**\$29<sup>95</sup>**  
Page 17

**COMPLETE SELECTIONS FOR THE HOME OR INDUSTRIAL PLANT**



**\$39<sup>90</sup>**  
Page 21

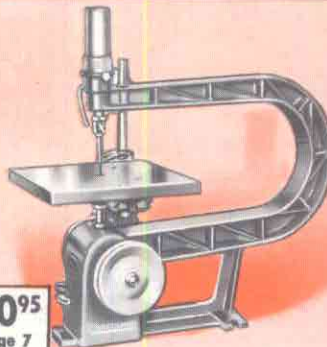

**\$10<sup>95</sup>**  
Page 7



**\$22<sup>50</sup>**  
Page 9