

# Power and Hand **TOOLS**

*Inside you'll find:*

Over 4000 items including some of the best buys in tools today!

**CRAFTSMAN**™ hand tools that are warranted forever!

Special Sears exclusives like our revolutionary tilt-head band saw (shown here) that lets you make bevel cuts while your workpiece remains on a flat surface (sold on page 142)

**CRAFTSMAN**  
QUALITY YOU'VE  
GROWN TO TRUST



**SEARS / CRAFTSMAN**

**12" Electronic Band Saw**

- 6" Depth of Cut
- Tilt Blade 0-45°
- Work Surface 23" x 27"
- Storage Cabinet with Door
- 12" Sanding Belt
- Built-in Work Light
- Digital Read Out
- Two Speeds

**1 1/8 HP**

**Tilt Head**

ELECTRONIC MEASUREMENT

**DANGER**  
ALLOW  
TOOL TO  
STOP  
BEFORE  
ADJUSTING

**SEARS / CRAFTSMAN**  
**12" BAND SAW**

**SEARS**  
Specialog™

Order from this  
"R" Catalog thru

**JANUARY 3, 1989**

...except where  
specified otherwise  
Satisfaction Guaranteed  
or Your Money Back

We asked do-it-yourselfers and mechanics throughout

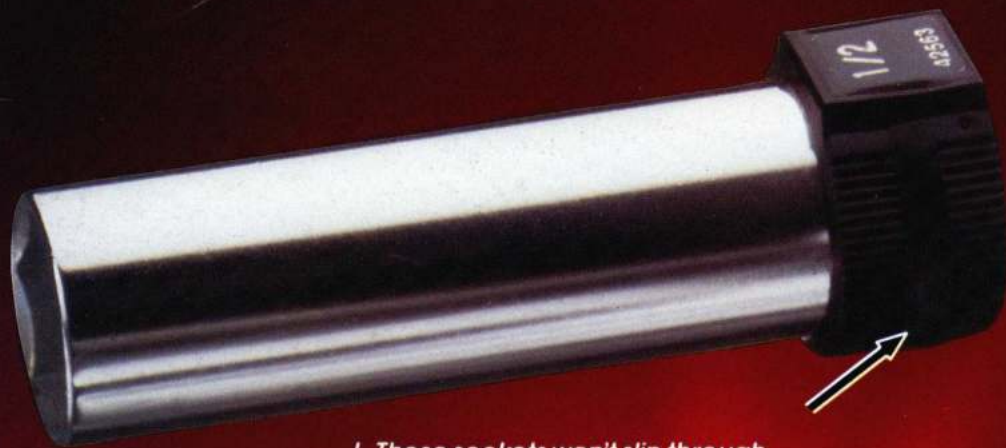

1. These sockets won't slip through greasy fingers thanks to our special "soft grip" band with flexible ribbing... lets your fingers tighten more quickly

2. No more chasing after runaway tools because the soft-sleeved band of our sockets and extension bars is designed with raised edges to stop tools from rolling on a flat surface



3. Our thinner ratchet head gets into places most ordinary ratchets can't reach

4. Convenient reversing lever and spinner located on top, close to your fingers for quicker on/off spinning of fasteners... serrated for easy turning

5. Durable stainless steel construction makes tools rust and chip resistant



6. You won't have to squint to see our easier to read sizes... they're stamped in bold characters on every gripping band

**SEARS BEST!**  
**CRAFTSMAN®**  
**Mechanics'**  
**Tools**

Available  
only at  
Sears!

Made  
proudly in  
the USA!

Fully tested and  
proven to possess  
the superior  
**CRAFTSMAN** quality  
you've come  
to trust!

the U.S.A. how they thought we could make a better tool. We took your suggestions to the drawing board and these are the results: a revolutionary line of SEARS BEST CRAFTSMAN<sup>®</sup> MECHANICS' TOOLS that are better than ordinary mechanics' tools in 8 innovative ways



7. Our handles are engineered with a 3" offset to prevent scraped knuckles when working in tight spots

8. You won't accidentally let go with this comfortable non-slip grip that also reduces arm fatigue

ONE QUALITY NAME  
**CRAFTSMAN**<sup>®</sup>  
OFFERS MORE GOOD CHOICES

Tools you can depend on for a lifetime of service...  
**THAT'S OUR WARRANTY!**

**FULL UNLIMITED WARRANTY.** If any CRAFTSMAN<sup>®</sup> Hand Tool ever fails to give complete satisfaction, simply return it to the nearest Sears store throughout the USA and Sears will replace it, free of charge. This warranty gives you specific legal rights and you may have other rights which vary from state to state.

**Extension bars**  
Constructed from alloy steel that is heat-treated, oil-quenched and tempered for extra strength, then nickel-chrome plated to resist rust and corrosion. Featuring our soft-grip band.

Sq. dr.	Lgth.	Cat. No.	Wt.	Price
1/4 in.	3 in.	9R 43534	1 oz.	\$4.69
1/4 in.	6 in.	9R 43535	1 oz.	5.19
3/8 in.	3 in.	9R 44273	3 oz.	5.19
3/8 in.	6 in.	9R 44274	4 oz.	5.49
1/2 in.	10 in.	9R 44275	5 oz.	8.29
1/2 in.	3 in.	9R 44136	4 oz.	5.79
1/2 in.	6 in.	9R 44137	6 oz.	7.19

**Quick-release ratchets**  
Made of durable stainless steel to resist corrosion and chipping.

Sq. dr.	Lgth.	Cat. No.	Wt.	Price
1/4 in.	5 1/2 in.	9R 43761	4 oz.	\$14.99
3/8 in.	7 1/2 in.	9R 43762	8 oz.	19.99
1/2 in.	10 1/2 in.	9R 43763	1 lb. 3 oz.	24.99

**Spark plug sockets.** Same construction as sockets at right.

Size in.	Pts.	Catalog Number	Wt. oz.	Ea.
1/2 in.	6	9R 43328	4	\$2.69
3/8 in.	6	9R 43329	4	2.69
1/2 in.	6	9R 42436	1	3.29
3/8 in.	6	9R 42437	1	3.29
1/2 in.	6	9R 42438	1	3.29
3/8 in.	6	9R 42439	1	3.29
1/2 in.	6	9R 42440	2	3.29
3/8 in.	6	9R 42441	2	3.29

**Sockets** Constructed from alloy steel that's been heat-treated, oil-quenched and tempered for extra strength, then nickel-chrome plated to resist rust and corrosion. Featuring our exclusive soft-grip band.

1/4-inch drive STANDARD sockets

Size in.	Pts.	Cat. No.	Wt. oz.	Ea.
5/32	6	9R 42499	1	\$1.99
3/16	6	9R 42508	1	1.99
7/32	6	9R 42509	1	1.99
1/4	6	9R 42501	1	1.99
5/32	6	9R 42502	1	1.99
3/16	6	9R 42503	1	1.99
1/32	6	9R 42504	1	1.99
3/8	6	9R 42505	1	1.99
7/16	6	9R 42506	1	1.99
1/2	6	9R 42507	1	1.99

1/4-inch drive STANDARD deep sockets

Size in.	Pts.	Cat. No.	Wt. oz.	Ea.
3/8	6	9R 42520	1	\$2.69
1/4	6	9R 42521	1	2.69
1/4	6	9R 42522	1	2.69
3/8	6	9R 42523	1	2.69
1/2	6	9R 42524	1	3.29
3/4	6	9R 42525	1	3.29
1/2	6	9R 42526	3	3.29
3/4	6	9R 42527	3	3.29

1/4-inch drive METRIC sockets

Size mm	Pts.	Cat. No.	Wt. oz.	Ea.
4	6	9R 42519	1	\$1.99
5	6	9R 42510	1	1.99
6	6	9R 42511	1	1.99
7	6	9R 42512	1	1.99
8	6	9R 42513	1	1.99
9	6	9R 42514	1	1.99
10	6	9R 42515	1	1.99
11	6	9R 42516	1	1.99
12	6	9R 42517	1	1.99
13	6	9R 42518	1	1.99

1/4-inch drive METRIC deep sockets

Size mm	Pts.	Cat. No.	Wt. oz.	Ea.
4	6	9R 42431	1	\$3.29
5	6	9R 42432	1	3.29
6	6	9R 42433	1	3.29
7	6	9R 42434	1	3.29
8	6	9R 42435	1	3.29
9	6	9R 42436	1	3.29
10	6	9R 42437	1	3.29
11	6	9R 42438	1	3.29
12	6	9R 42439	1	3.29
13	6	9R 42440	2	3.29
14	6	9R 42441	2	3.29

3/8-inch drive STANDARD sockets

Size in.	Pts.	Cat. No.	Wt. oz.	Ea.
3/8	6	9R 42531	1	\$2.79
7/16	6	9R 42532	1	2.79
1/2	6	9R 42533	1	2.79
5/8	6	9R 42534	1	2.79
3/4	6	9R 42535	1	2.79
1 1/8	6	9R 42536	1	2.79
3/4	6	9R 42537	2	2.79
1 3/8	6	9R 42538	2	2.79
1 1/2	12	9R 42451	1	2.79
7/8	12	9R 42452	1	2.79
1 1/4	12	9R 42453	1	2.79
1 1/2	12	9R 42454	1	2.79
1 3/4	12	9R 42455	1	2.79
1 7/8	12	9R 42456	1	2.79
2	12	9R 42457	1	2.79
2 1/8	12	9R 42458	1	2.79

3/8-inch drive STANDARD deep sockets

Size in.	Pts.	Cat. No.	Wt. oz.	Ea.
3/8	6	9R 42561	3	\$3.39
7/16	6	9R 42562	3	3.39
1/2	6	9R 42563	3	3.89
5/8	6	9R 42564	3	3.89
3/4	6	9R 42565	3	3.89
1 1/8	6	9R 42566	3	3.89
1 1/4	6	9R 42567	4	4.49
1 3/8	6	9R 42568	5	4.49
1 7/8	6	9R 42569	5	4.79

3/8-inch drive METRIC sockets

Size mm	Pts.	Cat. No.	Wt. oz.	Ea.
9	6	9R 42551	1	\$2.79
10	6	9R 42552	1	2.79
11	6	9R 42553	1	2.79
12	6	9R 42554	1	2.79
13	6	9R 42555	1	2.79
14	6	9R 42556	1	2.79
15	6	9R 42557	2	2.79
17	6	9R 42558	2	2.79
19	6	9R 42559	1	2.79
9	12	9R 42461	1	2.79
10	12	9R 42462	1	2.79
11	12	9R 42463	1	2.79
12	12	9R 42464	1	2.79
13	12	9R 42465	1	2.79
14	12	9R 42466	1	2.79
15	12	9R 42467	1	2.79
16	12	9R 42468	1	2.79
17	12	9R 42469	1	2.79
18	12	9R 42470	1	2.79
19	12	9R 42471	1	2.79

3/8-inch drive METRIC deep sockets

Size mm	Pts.	Cat. No.	Wt. oz.	Ea.
9	6	9R 42571	2	\$3.99
10	6	9R 42572	2	3.99
11	6	9R 42573	2	3.99
12	6	9R 42574	3	3.99
13	6	9R 42575	3	3.99
14	6	9R 42576	3	3.99
15	6	9R 42577	3	4.79
16	6	9R 42578	3	4.79
17	6	9R 42579	3	5.19
18	6	9R 42616	2	5.19
19	6	9R 42617	1	5.19

1/2-inch drive STANDARD sockets

Size in.	Pts.	Cat. No.	Wt. oz.	Ea.
7/16	6	9R 42622	2	\$3.49
1/2	6	9R 42581	3	3.49
9/16	6	9R 42582	3	3.49
5/8	6	9R 42583	2	3.49
1 1/16	6	9R 42584	3	3.49
3/4	6	9R 42585	4	3.99
7/8	6	9R 42586	4	3.99
1 1/8	6	9R 42587	4	4.69
1 1/4	6	9R 42588	4	4.69
1 1/2	6	9R 42589	5	4.69
1 3/8	6	9R 42590	6	5.19
1 7/8	6	9R 42592	7	5.19
2	6	9R 42593	8	5.19

1/2-inch drive STANDARD deep sockets

Size mm	Pts.	Cat. No.	Wt. oz.	Ea.
15	6	9R 42596	4	\$5.99
16	6	9R 42597	5	5.99
17	6	9R 42598	5	5.99
18	6	9R 42599	5	6.79
19	6	9R 42601	5	6.79
20	6	9R 42602	6	6.79
21	6	9R 42603	6	7.99
22	6	9R 42604	9	7.99
23	6	9R 42605	8	7.99
24	6	9R 42606	11	7.99
25	6	9R 42607	10	7.99

1/2-in. drive METRIC sockets

Size mm	Pts.	Cat. No.	Wt. oz.	Ea.
9	6	9R 42481	1	\$3.49
10	6	9R 42482	1	3.49
11	6	9R 42483	1	3.49
12	6	9R 42484	1	3.49
13	6	9R 42485	1	3.49
14	6	9R 42486	1	3.99
15	6	9R 42487	1	3.99
16	6	9R 42488	1	3.99
17	6	9R 42489	1	4.69
18	6	9R 42490	2	5.19

## CRAFTSMAN . . . a commitment to quality

We've worked hard for our #1 spot and we're working harder than ever to keep it

### What is QUALITY?

To us, quality is the will to make things better than they have to be. CRAFTSMAN® mechanics' tools are a classic example of this kind of commitment. So no wonder that the American consumer has voted us #1 year after year

### Just what makes CRAFTSMAN® tools so special?

#### 1. SUPERIOR CONSTRUCTION FEATURES

Every CRAFTSMAN® socket, ratchet and ratchet accessory is constructed from a select steel, heat-treated for extra strength, then oil-quenched and tempered for "through-hardening" which means no inner soft spots. Each tool has nickel-chrome plating to resist rust and corrosion. Thin-wall construction on ¼, ⅜ and ½-inch square drive sockets allows work in areas with limited clearance.

#### 2. A COMMITMENT TO INNOVATION

Not content to simply offer America's Best Selling Mechanics' Tools, we have committed ourselves to developing and perfecting innovations in the industry to make our tools better and better. One of our latest innovations is Sears exclusive quick-release/quick-clean ratchet, featuring a fully self-contained ratcheting mechanism that makes ratchet maintenance quick and easy (See the full quick-release/quick-clean story on page 15).

#### 3. SEARS LAB TESTING

The CRAFTSMAN label is more than just a name we stamp on our tools. It is the culmination of exhaustive research, design and development. But it doesn't stop there. After a CRAFTSMAN tool is designed, it goes through the Sears Lab . . . the biggest facility of its kind in American business. There, candidates are put through the most rigorous testing our lab can devise. Only after it passes this testing is it qualified to wear the CRAFTSMAN name. This testing is your assurance that you've received the finest quality we can offer.

#### 4. CRAFTSMAN FULL UNLIMITED WARRANTY!

You can expect a lifetime of dependable service from CRAFTSMAN® Mechanics' tools. We're so sure of that, we back each tool with an iron-clad warranty . . . no ifs, ands, or buts:

If any CRAFTSMAN® Hand Tool ever fails to give complete satisfaction, simply return it to the nearest Sears store throughout the USA and Sears will replace it, free of charge. This warranty gives you specific legal rights and you may also have other rights which vary from state to state.

So browse through the next few pages. Not only do we offer the best quality you're likely to find . . . this catalog represents one of the largest selection of sets sold in this country (including many sets available at Sears only in catalog). They are truly buys of a lifetime.

See Chart on page 10 for full details on pieces included in each of our Professional Sets

ONE QUALITY NAME

**CRAFTSMAN**

OFFERS MORE GOOD CHOICES

## HERE'S WHAT YOU GET:

176  
Wrenches

51  
Drive  
tools

325  
Sockets

348  
Additional  
tools including  
19 screwdrivers,  
9 pliers and  
two 59-pc. tap  
and die sets

### Our most complete 900-PIECE SET . . . the largest we've ever sold!

Includes ¼, ⅜, ½ and ¾-inch square drive sizes

Available in catalog only! 900-pc. set including all the individual tools listed in the chart on page 10. Separate prices total \$3829.67 on pages 15, 18 thru 26, 39 thru 41, 53, 64, 84, and 86. Shpg. wt. 275 lbs. 9 R 46388N . . . Set \$2899.00

Tool Set with Sears Best PRO SET 12-drawer chest and 8-drawer roll-away on facing page. See p. 29 for chest and roll-a-way descriptions. Sep. prices total \$4829.65 on pages listed at left and p. 29. Shpg. wt. 639 lbs. 9 R 43882N . . . Outfit \$3599.00

PRO SET Chest and Roll-a-way combination. Shpg. wt. 364 lbs. 9 R 65384N . . . Combination \$999.98

# 900 PIECE Professional Mechanics' Tool Set



**Don't miss  
these 2 great  
ways to save**

**on America's  
best selling  
Mechanics' Tool Sets!**

*Tool Set  
alone*

**Save  
\$930**

**\$2899**

*\$97 MONTHLY,  
see page 148*

*Tool Set with  
PRO SET Chest  
and Roll-a-way*

**Save  
\$1230**

**\$3599**

*\$120 MONTHLY,  
see page 148*

*PRO SET  
Chest and  
Roll-a-way*

**\$999<sup>98</sup>**

*\$34 MONTHLY,  
see page 148*

ONE QUALITY NAME

**CRAFTSMAN**

OFFERS MORE GOOD CHOICES

**CRAFTSMAN**® Professional

**718 PIECE SET** includes **STANDARD** and **METRIC** tools in

**HERE'S WHAT YOU GET:**

**150**  
Wrenches

**43**  
Drive  
tools

**281**  
Sockets

**244**  
Additional tools  
including  
19 screwdrivers,  
9 pliers and two  
59-pc. tap and  
die sets



Available at Sears in Catalog only! 718-piece tool set includes all the individual tools listed in the chart on page 10. Also see our great CRAFTSMAN construction features and FULL UNLIMITED WARRANTY on p. 4. Separate prices total \$2909.38 on pages 15, 18 thru 26, 40, 41, 53, 64, 84 and 86. 9 R 46386N—Shpg. wt. 172 lbs. . . Set \$2099.00  
\*See page 148

Tool Set (1) with 10-drawer chest and 5-drawer roll-a-way. See items (9) and (13) on page 28 for descriptions of chest, roll-a-way. Sep. prices total \$3359.36 on pgs. listed at left and p. 28. 9 R 43881N—Wt. 359 lbs. . . Outfit \$2263.58

Chest and Roll-a-way combination. Sep. prices total \$449.98. 9 R 65243N—Wt. 187 lbs. . . Combo \$404.98

**Don't miss  
these 3 great  
ways to save**

on America's best selling  
Mechanics' Tool Sets and  
Tool Storage Units!

Tool  
Set (1)  
alone

**Save \$810**  
**\$2099**  
\$70 MONTHLY\*

Tool Set (1)  
with Chest  
and Roll-a-way

**Save \$1095**  
**\$2263<sup>58</sup>**  
\$76 MONTHLY\*

# Mechanics' Tool Sets . . . WARRANTED FOREVER!

1/4, 3/8, 1/2 and 3/4 in. square drive sizes

**575 PIECE SET** includes STANDARD and METRIC tools in 1/4, 3/8, 1/2 and 3/4-in. sq. drive sizes

HERE'S WHAT YOU GET:



**130**  
Wrenches

**36**  
Drive tools

**187**  
Sockets

**222**  
Additional tools including 17 screwdrivers, 5 pliers and two 59-pc. tap and die sets



**2** Available at Sears in Catalog only! 575-pc. tool set has all the individual tools listed in the chart on p. 10. Also see our great CRAFTSMAN construction features and FULL UNLIMITED WARRANTY on page 4. Separate prices total \$2309.71 on pages 15, 18 thru 26, 40, 41, 84 and 86. Shpg. wt. 134 lbs. 9 R 46385N . . . Set \$1599.00

Tool Set (2) with 10-drawer Chest and 5-drawer Roll-a-way. See items (9) and (13) on p. 28 for descriptions of chest and roll-a-way. Separate prices total \$2759.69 on pgs. listed at left and page 28. Shpg. wt. 321 lbs. 9 R 43746N . . . Outfit \$1898.98  
Chest and Roll-a-way Combination. Sep. prices total \$449.98. Shpg. wt. 187 lbs. 9 R 65243N . . . Combo \$404.98

\*See page 148

Chest and Roll-a-way alone  
**Save \$45**  
**\$404<sup>98</sup>**  
\$15 MONTHLY\*

Tool Set (2) alone  
**Save \$710**  
**\$1599**  
\$54 MONTHLY\*

Tool Set (2) with Chest and Roll-a-way  
**Save \$860**  
**\$1898<sup>98</sup>**  
\$64 MONTHLY\*

Chest and Roll-a-way alone  
**Save \$45**  
**\$404<sup>98</sup>**  
\$15 MONTHLY\*

ONE QUALITY NAME

**CRAFTSMAN**

OFFERS MORE GOOD CHOICES

**CRAFTSMAN® Professional**

**404 PIECE SET** includes **STANDARD** and **METRIC** tools in  
**HERE'S WHAT YOU GET:**

**117**  
Wrenches

**28**  
Drive  
tools

**176**  
Sockets

**83**  
Additional tools  
including  
9 screwdrivers  
and 4 pliers



| Available at Sears in Catalog only! 404-pc. set includes all the individual tools in the chart on p. 8. Also see our great CRAFTSMAN construction features and FULL UNLIMITED WARRANTY on p. 4. Separate prices total \$1676.01 on pages 15, 18 thru 25, 41, 84 and 86.  
9 R 46384N—Shpg. wt. 97 lbs. . . Set \$1049.00

Tool set with 6-drawer chest and 5-drawer roll-a-way. See items (8) and (12) on p. 28 for descriptions of chest and roll-a-way. Separate prices total \$2075.99 on pages listed at left and p. 28.  
9 R 43913N—Shpg. wt. 259 lbs. . . Outfit \$1349.97  
Chest and Roll-a-way Combination. Separate prices total \$399.98.  
9 R 65449N—Shpg. wt. 162 lbs. . . Combo. \$359.98

**Don't miss  
these 3 great  
ways to save**

**on America's best selling  
Mechanics' Tool Sets and  
Tool Storage Units!**

Tool Set (I)  
alone

**Save  
\$627**

**\$1049**

\$35 MONTHLY,  
see page 148

Tool Set (I) with Chest  
and Roll-a-way above

**Save  
\$726**

**\$1349<sup>97</sup>**

\$45 MONTHLY,  
see page 148

# Mechanics' Tool Sets are WARRANTED FOREVER!

1/4, 3/8, 1/2 and 3/4 in. square drive sizes

**324 PIECE SET** includes STANDARD and METRIC tools in 1/4, 3/8, and 1/2 in. sq. drive sizes

HERE'S WHAT YOU GET:

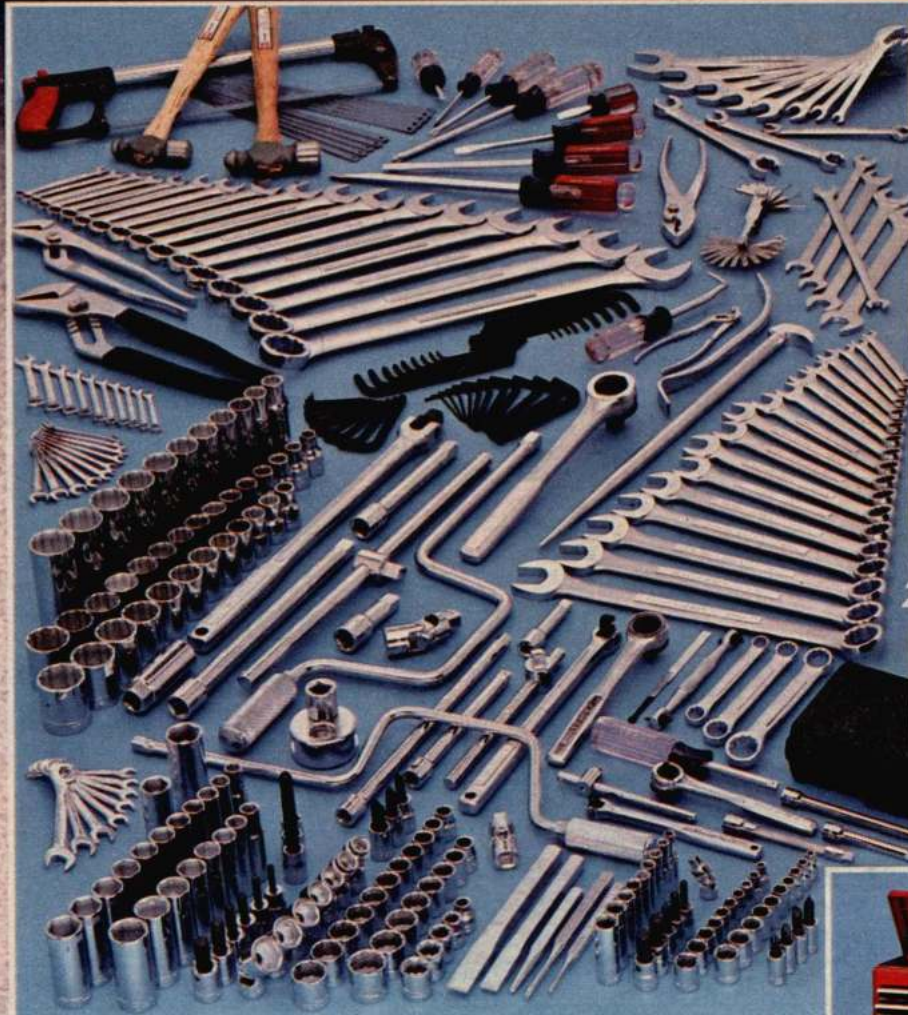

**81**  
Wrenches

**25**  
Drive tools

**141**  
Sockets

**77**  
Additional tools including 9 screwdrivers and 4 pliers



2 Available at Sears in Catalog only! 324-pc. set has all the individual tools in the chart on page 9. Also see our great CRAFTSMAN construction features and FULL UNLIMITED WARRANTY on page 4. Separate prices total \$1226.92 on pages 15, 18 thru 25, 41, 84 and 86. 9 R 46383C—Wt. 69 lbs. . . Set \$749.00

Tool set with 6-drawer chest and 5-drawer roll-a-way. See items (8) and (12) on page 28 for descriptions of chest and roll-a-way. Sep. prices total \$1626.90 on pgs. listed at left and p. 28. Wt. 231 lbs. 9 R 43914N . . . Outfit \$979.98 Chest and Roll-a-way combination. Sep. prices total \$399.98. Wt. 162 lbs. 9 R 65449N . . . Combo \$359.98

Chest and Roll-a-way alone  
**Save \$40**  
**\$359<sup>98</sup>**  
\$14 MONTHLY, see page 148

Tool Set (2) alone  
**Save \$477**  
**\$749**  
\$25 MONTHLY, see page 148

Tool Set (2) with Chest and Roll-a-way above  
**Save \$646**  
**\$979<sup>98</sup>**  
\$33 MONTHLY, see page 148

Chest and Roll-a-way alone  
**Save \$40**  
**\$359<sup>98</sup>**  
\$14 MONTHLY, see page 148

# In detail, HERE'S WHAT YOU GET in our CRAFTSMAN® Professional Mechanics

Tool	Description	900-pc. Set on pgs. 4, 5 OUR MOST COMPLETE (9 R 46388N)	718-pc. Set on page 6 (9 R 46386N)	575-pc. Set on page 7 (9 R 46385N)	404-pc. Set on page 8 (9 R 46384N)	324-pc. Set on page 9 (9 R 46383C)
<b>1/4-INCH SQUARE DRIVE PARTS</b>						
Sockets	6-pt. standard 6-pt. std. deep 6-pt. metric 6-pt. metric deep 12-pt. standard Screwdriver bit socket Hex bit socket Torx bit socket	10 (3/32 thru 1/2 in.) 9 (3/16 thru 1/2 in.) 10 (4 thru 13mm) 11 (4 thru 14mm) 9 (3/16 thru 1/2 in.) 4 (2 slotted, 2 Phillips) 5 (3/16 thru 3/8 in.) 3 (T-15, T-20, T-25)	10 (3/32 thru 1/2 in.) 9 (3/16 thru 1/2 in.) 10 (4 thru 13mm) 11 (4 thru 14mm) 9 (3/16 thru 1/2 in.) 4 (2 slotted, 2 Phillips) 5 (3/16 thru 3/8 in.)	10 (3/32 thru 1/2 in.) 9 (3/16 thru 1/2 in.) 10 (4 thru 13mm) 11 (4 thru 14mm) 9 (3/16 thru 1/2 in.) 4 (2 slotted, 2 Phillips) 5 (3/16 thru 3/8 in.)	10 (3/32 thru 1/2 in.) 9 (3/16 thru 1/2 in.) 10 (4 thru 13mm) 11 (4 thru 14mm) 9 (3/16 thru 1/2 in.) 4 (2 slotted, 2 Phillips) 5 (3/16 thru 3/8 in.)	10 (3/32 thru 1/2 in.) 9 (3/16 thru 1/2 in.) 10 (4 thru 13mm) 11 (4 thru 14mm) 9 (3/16 thru 1/2 in.) 4 (2 slotted, 2 Phillips) 5 (3/16 thru 3/8 in.)
Drive Tools	Ratchet Extension bar Flex extension Adapter Flex "T"-handle Universal joint Spinner handle Speeder Slide bar	2 (fine-tooth, wrist) 4 (1 1/2, 3, 6, 14 in.) 4 in. 2 (3/8 in., wrist ratchet) 6 in. one 3 (4 1/2 in., 6 in., 6 in. flex) 15 1/2 inch 4 1/2 in.	fine-tooth 4 (1 1/2, 3, 6, 14 in.) 4 inch 3/8 6 inch one 6 inch 15 1/2 inch 4 1/2 inch	fine-tooth 2 (3, 6 in.) 4 inch 3/8 6 inch one 6 inch 15 1/2 inch 4 1/2 inch	fine-tooth 2 (3, 6 in.) 4 inch 3/8 6 inch one 2 (6 in., 6 in. flex) 4 1/2 inch	fine-tooth 2 (3, 6 in.) 4 inch 3/8 6 inch one 6 inch 15 1/2 inch 4 1/2 inch
<b>3/8-INCH SQUARE DRIVE PARTS</b>						
Sockets	6-pt. standard 6-pt. std. deep 6-pt. flex 6-pt. std. impact 6-pt. metric 6-pt. metric deep 6-pt. metric flex 8-pt. standard 12-pt. standard 12-pt. std. deep 12-pt. std. flex 12-pt. metric 12-pt. metric deep Screwdriver bit socket Hex bit (standard) Hex bit (metric) Torx bit socket 6-pt. spark plug socket 6-pt. flex spark plug	8 (3/8 thru 1 1/8 in.) 6 (3/8 thru 3/4 in.) 7 (3/8 thru 3/4 in.) 7 (3/8 thru 1 1/8 in.) 9 (9 thru 15, 17, 19mm) 11 (9 thru 19mm) 10 (10 thru 19mm) 5 (1/4 thru 1/2 in.) 8 (3/8 thru 1 1/8 in.) 9 (3/8 thru 3/4 in.) 7 (3/8 thru 3/4 in.) 11 (9 thru 19mm) 11 (9 thru 19mm) 7 (3 slotted, 4 Phillips) 6 (3/8 thru 3/4 in.) 6 (4 thru 8, 10mm) 4 (T-30, T-40, T-45, T-50) 2 (3/8, 1 1/8 in.) 2 (3/8, 1 1/8 in.)	8 (3/8 thru 1 1/8 in.) 9 (3/8 thru 3/4 in.) 7 (3/8 thru 3/4 in.) 7 (3/8 thru 1 1/8 in.) 9 (9 thru 15, 17, 19mm) 11 (9 thru 19mm) 10 (10 thru 19mm) 5 (1/4 thru 1/2 in.) 8 (3/8 thru 1 1/8 in.) 9 (3/8 thru 3/4 in.) 11 (9 thru 19mm) 11 (9 thru 19mm) 6 (3 slotted, 3 Phillips) 6 (3/8 thru 3/4 in.) 2 (3/8, 1 1/8 in.) 2 (3/8, 1 1/8 in.)	8 (3/8 thru 1 1/8 in.) 7 (3/8 thru 3/4 in.) 7 (3/8 thru 1 1/8 in.) 11 (9 thru 19mm) 10 (10 thru 19mm) 5 (1/4 thru 1/2 in.) 8 (3/8 thru 1 1/8 in.) 11 (9 thru 19mm) 11 (9 thru 19mm) 6 (3 slotted, 3 Phillips) 6 (3/8 thru 3/4 in.) 2 (3/8, 1 1/8 in.) 2 (3/8, 1 1/8 in.)	8 (3/8 thru 1 1/8 in.) 7 (3/8 thru 3/4 in.) 11 (9 thru 19mm) 10 (10 thru 19mm) 5 (1/4 thru 1/2 in.) 8 (3/8 thru 1 1/8 in.) 11 (9 thru 19mm) 11 (9 thru 19mm) 6 (3 slotted, 3 Phillips) 6 (3/8 thru 3/4 in.) 2 (3/8, 1 1/8 in.) 2 (3/8, 1 1/8 in.)	8 (3/8 thru 1 1/8 in.) 7 (3/8 thru 3/4 in.) 11 (9 thru 19mm) 10 (10 thru 19mm) 5 (1/4 thru 1/2 in.) 8 (3/8 thru 1 1/8 in.) 11 (9 thru 19mm) 11 (9 thru 19mm) 6 (3 slotted, 3 Phillips) 6 (3/8 thru 3/4 in.) 2 (3/8, 1 1/8 in.) 2 (3/8, 1 1/8 in.)
Drive Tools	Ratchet Extension bar Adapter Flex "T"-handle Universal joint Speeder Slide bar	2 (fine-tooth, flex) 5 (1 1/2, 3, 6, 10, 20 in.) 2 (1/4, 1/2 in.) 10 in. one 16 in. 7 in.	2 (fine-tooth, flex) 5 (1 1/2, 3, 6, 10, 20 in.) 2 (1/4, 1/2 in.) 10 inch one 16 inch 7 inch	2 (fine-tooth, flex) 5 (1 1/2, 3, 6, 10, 20 in.) 2 (1/4, 1/2 in.) 10 inch one 16 inch 7 inch	fine-tooth 3 (3, 6, 10 in.) 10 inch one 16 inch 7 inch	fine-tooth 3 (3, 6, 10 in.) 10 inch one 16 inch 7 inch
<b>1/2-INCH SQUARE DRIVE PARTS</b>						
Sockets	6-pt. standard 6-pt. metric 6-pt. std. impact 6-pt. std. deep 8-pt. standard 12-pt. standard 12-pt. std. deep 12-pt. metric 12-pt. metric deep Drag socket 6-pt. spark plug	13 (1/2 thru 1 1/4 in.) 10 (9 thru 15, 17, 19, 22mm) 10 (1/2 thru 1 in.) 11 (1/2 thru 1 1/8 in.) 6 (7/8 thru 3/4 in.) 13 (1/2 thru 1 1/4 in.) 11 (1/2 thru 1 1/8 in.) 18 (9 thru 19, 21, 22, 24, 27, 30, 32, 36mm) 6 (14, 17, 19, 21, 22, 27mm) 4 (3/8 thru 1 1/8 in.) 2 (3/8, 1 1/8 in.)	13 (1/2 thru 1 1/4 in.) 10 (9 thru 15, 17, 19, 22mm) 10 (1/2 thru 1 in.) 6 (7/8 thru 3/4 in.) 13 (1/2 thru 1 1/4 in.) 11 (1/2 thru 1 1/8 in.) 17 (9 thru 19, 21, 22, 24, 27, 30, 32mm) 6 (14, 17, 19, 21, 22, 27mm) 1 1/8 in.	13 (1/2 thru 1 1/4 in.) 10 (9 thru 15, 17, 19, 22mm) 10 (1/2 thru 1 in.) 6 (7/8 thru 3/4 in.) 13 (1/2 thru 1 1/4 in.) 11 (1/2 thru 1 1/8 in.) 14 (9 thru 19, 21, 22, 24mm) 6 (14, 17, 19, 21, 22, 27mm) 1 1/8 in.	12 (7/8 thru 1 1/8 in.) 11 (1/2 thru 1 1/8 in.) 15 (9 thru 19, 21, 22, 24, 27mm) 1 1/8 in.	12 (7/8 thru 1 1/8 in.) 11 (1/2 thru 1 1/8 in.) 15 (9 thru 19, 21, 22, 24, 27mm) 1 1/8 in.
Drive Tools	Ratchet Extension bar Adapter Flex "T"-handle Universal joint Speeder Slide bar Stud extractor	2 (fine-tooth, flex) 5 (2, 3, 6, 10, 20 in.) 2 (3/8, 1 in.) 2 (15, 18 in.) one 18 in. 2 (9, 15 in.) one	2 (fine-tooth, flex) 5 (2, 3, 6, 10, 20 in.) 3/8 inch 15 inch one 18 inch 15 inch one	2 (fine-tooth, flex) 3 (3, 6, 10 in.) 3/8 inch 15 inch one 18 inch 15 inch one	fine-tooth 3 (3, 6, 10 in.) 15 inch one 18 inch 9 inch one	fine-tooth 3 (3, 6, 10 in.) 15 inch one 18 inch 15 inch one
<b>3/4-INCH SQUARE DRIVE PARTS</b>						
Sockets	12-pt. standard	21 (7/8 thru 2 3/8 in.)	15 (1 thru 2 in.)	14 (1 1/8 thru 2 in.)	15 (1 thru 2 in.)	
Drive Tools	Ratchet Extension bar Flex "T"-handle Slide bar	quick-release 3 (5, 8, 16 in.) 18 in.	quick-release 2 (5, 8 in.) 18 in. 18 in.	quick-release 8 in.	quick-release 8 in. 18 in.	
<b>WRENCHES</b>						
Combination	Standard Metric	18 (1/4 thru 1 1/8 in.) 25 (6 thru 28, 30, 32mm)	17 (1/4 thru 1 1/4 in.) 20 (7 thru 24, 27, 30mm)	17 (1/4 thru 1 1/4 in.) 18 (7 thru 24mm)	16 (1/4 thru 1 1/8 in.) 19 (7 thru 24, 27mm)	17 (1/4 thru 1 1/4 in.) 17 (7 thru 22, 24mm)
Open-end	Standard Metric	14 (1/4x3/8 thru 1 1/2x1 1/8 in.) 14 (6x8 thru 30x32mm)	8 (1/4x3/8 thru 1 1/2x1 1/8 in.) 8 (6x8 thru 22x24mm)	8 (1/4x3/8 thru 1 1/2x1 1/8 in.) 8 (6x8 thru 22x24mm)	9 (1/4x3/8 thru 1 1/2x1 1/8 in.) 10 (6x8 thru 22x24mm)	8 (1/4x3/8 thru 1 1/2x1 1/8 in.)
Box-end	Standard short Standard Metric Std. ratcheting Metric ratcheting	3 (3/8x7/8 thru 3/4x3/4 in.) 13 (1/4x3/8 thru 1 1/2x1 1/8 in.) 15 (6x8 thru 30x32mm) 5 (1/4x3/8 thru 1 1/2x1 1/8 in.) 5 (6x8 thru 17x19mm)	3 (3/8x7/8 thru 3/4x3/4 in.) 8 (1/4x3/8 thru 1 1/2x1 1/8 in.) 5 (1/4x3/8 thru 1 1/2x1 1/8 in.) 5 (6x8 thru 17x19mm)	3 (3/8x7/8 thru 3/4x3/4 in.) 3 (3/8x7/8 thru 3/4x3/4 in.) 5 (1/4x3/8 thru 1 1/2x1 1/8 in.) 5 (6x8 thru 17x19mm)	3 (3/8x7/8 thru 3/4x3/4 in.) 3 (3/8x7/8 thru 3/4x3/4 in.) 3 (3/8x7/8 thru 3/4x3/4 in.) 3 (3/8x7/8 thru 3/4x3/4 in.)	3 (3/8x7/8 thru 3/4x3/4 in.) 3 (3/8x7/8 thru 3/4x3/4 in.) 3 (3/8x7/8 thru 3/4x3/4 in.) 3 (3/8x7/8 thru 3/4x3/4 in.)
Open-end/ socket	Standard	7 (3/8 thru 3/4 in.)	7 (3/8 thru 3/4 in.)	7 (3/8 thru 3/4 in.)		
Flare nut	Standard Metric	3 (3/8x7/8 thru 3/4x1 1/8 in.) 5 (9x11 thru 19x21mm)	3 (3/8x7/8 thru 3/4x1 1/8 in.) 5 (9x11 thru 19x21mm)	3 (3/8x7/8 thru 3/4x1 1/8 in.) 5 (9x11 thru 19x21mm)	3 (3/8x7/8 thru 3/4x1 1/8 in.) 5 (9x11 thru 19x21mm)	3 (3/8x7/8 thru 3/4x1 1/8 in.) 5 (9x11 thru 19x21mm)
Thin-head	Standard	5 (3/8x7/8 thru 3/4x3/4 in.)	5 (3/8x7/8 thru 3/4x3/4 in.)	5 (3/8x7/8 thru 3/4x3/4 in.)	5 (3/8x7/8 thru 3/4x3/4 in.)	5 (3/8x7/8 thru 3/4x3/4 in.)
Combination ignition	Standard Metric	10-pc. set 10-pc. set	10-pc. set 10-pc. set	10-pc. set 10-pc. set	10-pc. set 10-pc. set	10-pc. set 10-pc. set
Open-end ignition	Standard Metric	8-pc. set 8-pc. set	8-pc. set 8-pc. set	8-pc. set 8-pc. set	8-pc. set 8-pc. set	8-pc. set 8-pc. set
Crowfoot (3/8-in. sq. dr.)	Standard Metric	10 (3/8 thru 1 in.) 10 (10 thru 19mm)	10 (3/8 thru 1 in.) 10 (10 thru 19mm)	10 (3/8 thru 1 in.)	10 (3/8 thru 1 in.)	
Midget box	Standard Metric	4 (3/8x1 1/4 thru 3/8x1 1/2 in.) 4 (4.5x5 thru 8x9mm)				

Don't miss our fine quality CRAFTSMAN construction features and our FULL UNLIMITED WARRANTY on page 4

ONE QUALITY NAME

**CRAFTSMAN**

OFFERS MORE GOOD CHOICES

**Tool Sets sold on pages 4 thru 9**

**Additional Tools:** All 5 Sets incl. ignition file, rolling wedge bar, ignition gauge, cotter key extractor, brake adjusting tool, Permanex® plastic box for ¼-in. sq. drive tools; hacksaw; 10 blades.

**900-pc. Set also has Nutdrivers:** 7 std. (¾ thru ½ in.); 7 metric (5 thru 11mm). **Pliers:** hose clamp; 6-in. bent needle-nose; 7-in. diagonal-cutting; 3 Arc Joint® (7, 9½, 12½ in.); 2 slip-joint (6¾, 8 in.); 5-in. ignition; 1 snap ring. **Screwdrivers:** 8 Phillips; 11 slotted. **Files:** round, mill, 2 half-round. **Line-up punch;** 12-pc. punch and chisel set; two 20-pc. hex key sets (1 std., 1 metric plus 12, 17mm hex keys); two 59-pc. **Tap and Die Sets** (1 std., 1 metric); scratch awl, pry bar; 5 extra hacksaw blades. 2 ball-pein hammers (8, 12 oz.); 12-oz. plastic-tip hammer; 6-in. rule; gap gauge; non-magnetic feeler gauge; 3-pc. ratchet speed adapter set; 16 inserts (3 spark plug, 5 magnetic, 8 spark plug thread); 2 valve grinders; universal OV valve spring compressor; oil pressure/stop light socket; remote control starter; voltage tester; parts cleaning brush. 3 wire brushes; 5-pc. 14mm cylinder head rethreader kit; 8-pc. screw extractor kit; scraper; mechanics' stethoscope; 2-pc. air hold fittings; 11-pc. steering wheel puller set; tire valve repair tool and 22 steel socket trays.

**718-pc. Set also has Nutdrivers:** 7 std. (¾ thru ½ in.); 7 metric (5 thru 11 mm). **Pliers:** 3 Arc Joint® (7, 9½, 12½ in.); 7-in. diagonal cutting; 2 slip-joint (6¾, 8-in.); 6-in. bent needle-nose; 5-in. ignition; 1 snap-ring. **Screwdrivers:** 11 slotted (stubby, ½x2 thru ¾x12 in.); 7 Phillips (stubby, Nos. 0, 1, 2, 2x8, 3, 4); 1 offset. 2 ball pein hammers (8, 12-oz.). 12-oz. plastic tip hammer. **Two 59-pc. Tap and Die Sets:** 1 std., 1 metric. **Two 20-pc. hex key sets:** 1 std., 1 metric plus 12, 17 mm hex keys. 12-pc. Punch and Chisel set. Gap gauge. **Files:** mill, round, 2 half-round. Pry bar, rule, feeler gauge, line-up punch and scratch awl.

**575-pc. Set also has Nutdrivers:** 7 std. (¾ thru ½ in.); 7 metric (5 thru 11 mm). **Pliers:** 2 Arc Joint® (9½, 12½ in.); 7-in. diagonal-cutting; 8-in. slip-joint; 5-in. ignition. **Screwdrivers:** 9 slotted (stubby, ¾x4 thru ¾x12 in.); 7 Phillips (stubby, Nos. 0, 1, 2, 2x8, 3, 4); 1 offset. 2 ball pein hammers (8, 12 oz.). **Two 59-pc. Tap and Die Sets:** 1 std., 1 metric. **Two 20-pc. hex key sets;** 1 std., 1 metric plus 12, 17 mm hex keys. 5-pc. Punch and Chisel set; gap gauge and scratch awl.

**404-pc. Set also has 7 std. Nutdrivers** (¾ thru ½ in.). **Pliers:** 9½-in. Arc Joint®; 7-in. diagonal-cutting; 6¾-in. slip-joint; 5-in. ignition. **Screwdrivers:** 4 slotted (stubby, ¾x4 thru ¾x8 in.); 4 Phillips (stubby, Nos. 1, 2, 3); 1 offset. 12-oz. ball pein hammer. **Two 20-pc. hex key sets:** 1 std., 1 metric. 5-pc. Punch and Chisel set. 8-in. adjustable wrench.

**324-pc. Set also has Pliers:** 2 Arc Joint® (9½, 12½ in.); 8-in. slip-joint; 5-in. ignition. **Screwdrivers:** 4 slotted (stubby, ¾x4 thru ¾x8 in.); 4 Phillips (stubby, Nos. 1, 2, 3); 1 offset. 2 ball pein hammers (8, 12 oz.). **Two 20-pc. hex key sets:** 1 std., 1 metric. 5-pc. Punch and Chisel set.



Tool Set alone  
**Save 46%**  
**\$289<sup>99</sup>**  
\$13 MONTHLY†

Tool Set with Tool Box  
**Save \$21 more**  
**\$323<sup>98</sup>** \$13 MONTHLY†



**New at Sears! CRAFTSMAN® 215 PIECE STANDARD and METRIC Mechanics' Tool Set includes ¼, ⅜ and ½-inch square drive sizes . . . WARRANTED FOREVER!**

**HERE'S WHAT YOU GET:**

- 127 Sockets
- 11 Drive tools
- 36 Wrenches
- 41 Additional tools

This set includes the tools you'll need for auto or household repair. Constructed from select steel that's heat-treated and oil-quenched for extra strength, then chrome-plated for corrosion and rust resistance. Includes

**¼ in. sq. drive:** ten 6 pt. sockets (¾ thru ½-in.); Ten 6 pt. metric sockets (4 thru 13mm); five 6 pt. deep sockets (¾ thru ½-in.); seven 6 pt. metric deep sockets (8 thru 14mm); nine 12 pt. sockets (¾ thru ½-in.); quick-release ratchet; spinner handle (6-in.); 3 extension bars (1½, 3, 6-in.).

**⅜ in. sq. drive:** eight 6 pt. sockets (¾ thru ¾-in.); nine 6 pt. metric sockets (9 thru 15, 17, 19mm); seven 6 pt. deep sockets (½ thru ¾-in.); ten 6 pt. metric deep sockets (10 thru 19mm); three 8 pt. sockets (¾, ¾, ½-in.); eight 12 pt. sockets (¾ thru ¾-in.); eleven 12 pt. metric sockets (9 thru 19mm); spark plug socket (¾-in.); quick-release ratchet; adapter (¼-in.); 2 extension bars (3, 6-in.).

**½-in. sq. drive:** three 8 pt. sockets (½, ½, ¾-in.); twelve 12 pt. sockets (7/16 thru 1½-in.); twelve 12 pt. metric sockets (14 thru 19, 21, 22, 24, 27, 30, 32mm); 2 spark plug sockets (¾, ¾-in.); quick-release ratchet; extension bar (3-in.).

**Wrenches:** 8 combination wrenches (¼ thru ¾-in.); 8 metric combination wrenches (8 thru 15mm); two 10 pc. combination miniature wrench sets (std., metric).

**Additional tools:** 3 crowfoot wrenches (7/16, ½, ¾-in.); 4 Nutdrivers; 20 pc. hex key set; 14 pc. metric hex key set. Sep. prices total \$541.25 on pgs. 15, 18 thru 24. Shpg. wt. 24 lbs. 9 R 33715C . . . Set \$289.99

**Tool Set with Tool Box sold separately on p. 33. Separate prices total \$344.98. Wt. 47 lbs. 9 R 43817C . . . Outfit \$323.98 †See page 148.**

When you buy CRAFTSMAN® Mechanics' Tools,

## 165-PIECE CRAFTSMAN® Mechanics' Tool Set with STANDARD and METRIC Tools

HERE'S WHAT YOU GET:

- 110 Sockets
- 28 Wrenches
- 10 Drive Tools
- 17 Additional Tools

Tool Set (1) alone  
Save 50%  
**\$209<sup>99</sup>**  
\$11 MONTHLY†

Tool Set (1)  
with Tool Chest  
Save  
\$10 more  
**\$223<sup>98</sup>**  
\$11 MONTHLY†



1 thru 5 These sets are perfect for household or auto repair. Plus you'll never buy a replacement tool, unless you lose one, because if any tool fails to meet your satisfaction for any reason, we'll replace it free of charge! We can offer this iron-clad warranty because of our fine CRAFTSMAN construction features. This set has been crafted from select steel, heat-treated for extra strength then oil-quenched for hardness. Each piece is then chrome-plated to resist rust and corrosion. See our Full Unlimited Warranty on facing page. Separate prices from pages 15, 18 thru 24.

1 165-piece set includes 1/4-in. sq. drive: ten 6-pt. sockets (5/8 thru 1/2-in.); ten 6-pt. metric sockets (4 thru 13mm); five 6-pt. deep sockets (5/8 thru 1/2-in.); seven 6-pt. metric deep sockets (8 thru 14mm); nine 12-pt. sockets (3/8 thru 1/2-in.); quick-release ratchet; spinner handle; 2 extension bars (1 1/2, 3-in.); 3/8-in. sq. drive: eight 6-pt. sockets (3/8 thru 1 3/16-in.); nine 6-pt. metric sockets (9 thru 15, 17, 19mm); six 6-pt. deep sockets (1/2 thru 1 3/16-in.); nine 6-pt. metric deep sockets (10 thru 18mm); eight 12-pt. sockets (3/8 thru 1 3/16-in.); eleven 12-pt. metric sockets (9 thru 19mm); spark plug socket (5/8-in.); quick-release ratchet; adapter (1/4-in.); 2 extension bars (3, 6-in.). 1/2-in. sq. drive: nine 12-pt. sockets (7/16 thru 1 3/16-in.); seven 12-pt. metric sockets (14 thru 19, 22mm); spark plug socket (1 3/16-in.); quick-release ratchet; extension bar (3-in.). Wrenches: 6 combination wrenches (1/4 thru 5/8-in.); 6 metric combination wrenches (9 thru 14mm); two 8-pc. combination miniature wrench sets (std., metric). Additional tools: 3 nutdrivers; 14-pc. hex key set. Separate prices total \$421.02.  
9 R 33714C—Shpg. wt. 18 lbs. . . Set \$209.99

Tool Set (1) with Tool Chest (4) sold sep. on p. 32. Separate prices total \$233.98.  
9 R 43813C—Shpg. wt. 28 lbs. . . Outfit \$223.98

SearsCharge and Discover Card... each is different, but together they're all you really need

To apply for SearsCharge only  
CALL TOLL FREE  
1-800-323-3274  
IN ILLINOIS CALL  
1-800-942-7446

2 105-piece set includes 1/4-in. sq. drive: ten 6-pt. sockets (5/8 thru 1/2-in.); ten 6-pt. metric sockets (4 thru 13mm); five 6-pt. deep sockets (5/8 thru 1/2-in.); five 6-pt. metric deep sockets (8 thru 12mm); eight 12-pt. sockets (3/8 thru 1/2-in.); quick-release ratchet; extension bar (3-in.). 3/8-in. sq. drive: eight 6-pt. sockets (3/8 thru 1 3/16-in.); five 6-pt. deep sockets (1/2 thru 3/4-in.); five 6-pt. deep metric sockets (13 thru 17mm); three 8-pt. sockets (3/8, 7/16, 1/2-in.); seven 12-pt. sockets (3/8 thru 3/4-in.); nine 12-pt. metric sockets (9 thru 17mm); spark plug socket (5/8-in.); quick-release ratchet; extension bar (3-in.). 1/2-in. sq. drive: seven 12-pt. sockets (1/2 thru 3/8-in.); five 12-pt. metric sockets (15 thru 19mm); quick-release ratchet. Wrenches: 6 combination wrenches (5/8 thru 5/8-in.). Additional tools: 6 pc. hex key set. Separate prices total \$277.91.  
9 R 33713—Shpg. wt. 12 lbs. 8 oz. . . Set \$144.99

Tool Set (2) with Tool Chest (4) sold separately on page 32. Separate prices total \$168.98.  
9 R 43814C—Shpg. wt. 23 lbs. . . Outfit \$158.98

3 thru 5 These sets feature our exclusive quick-clean/quick-release ratchets. Ratchets have a fully self-contained ratcheting mechanism that allows you to clean the ratchet quickly and easily. Simply push button to release the mechanism then clean. Snap mechanism back in place and you're ready to go.

3 59-piece set includes 1/4-in. sq. drive: ten 6-pt. sockets (5/8 thru 1/2-in.); ten 6-pt. metric sockets (4 thru 13mm); extension bar (3-in.); spinner handle; quick-clean/quick-release ratchet. 3/8-in. sq. drive: five 6-pt. deep metric sockets (10, 12 thru 15mm); eight 12-pt. sockets (3/8 thru 1 3/16-in.); seven 12-pt. metric sockets (10 thru 15, 17mm); six 12-pt. deep sockets (3/8 thru 3/4-in.); spark plug socket (5/8-in.); extension bar (6-in.); quick-clean/quick-release ratchet.

1/2-in. sq. drive: six 12-pt. sockets (3/8 thru 7/8-in.); quick-clean/quick-release ratchet. Separate prices total \$184.31.  
9 R 33712—Shpg. wt. 8 lbs. 14 oz. . . Set \$76.99

Tool Set (3) with Tool Chest (4) sold separately on page 32. Separate prices total \$100.98.  
9 R 43815C—Shpg. wt. 19 lbs. . . Outfit \$90.98

4 37-piece standard set includes 1/4-in. sq. drive: ten 6-pt. sockets (5/8 thru 1/2-in.); extension bar (3-in.); spinner handle; quick-clean/quick-release ratchet. 3/8-in. sq. drive: eight 12-pt. sockets (3/8 thru 1 3/16-in.); six 12-pt. deep sockets (3/8 thru 3/4-in.); spark plug socket (5/8-in.); extension bar (6-in.); quick-clean/quick-release ratchet. 1/2-in. sq. drive: six 12-pt. sockets (3/8 thru 7/8-in.); ratchet handle. Separate prices total \$137.33.  
9 R 33711—Shpg. wt. 7 lbs. 1 oz. . . Set \$47.99

37-piece metric set includes 1/4-in. sq. drive: ten 6-pt. metric sockets (4 thru 13mm); extension bar (3-in.); spinner handle; quick-clean/quick-release ratchet. 3/8-in. sq. drive: six 6-pt. deep metric sockets (10, 12 thru 15, 17mm); eight 12-pt. metric sockets (10 thru 14, 15, 17, 19mm); spark plug socket (5/8-in.); extension bar (6 in.); quick-clean/quick-release ratchet. 1/2-in. sq. drive: six 12-pt. sockets (15, 17, 18, 19, 22, 24mm); ratchet handle. Separate prices total \$143.83.  
9 R 33721—Shpg. wt. 7 lbs. 1 oz. . . Set \$47.99

5 30-piece standard set includes 1/4-in. sq. drive: ten 6-pt. sockets (5/8 thru 1/2-in.); extension bar (3-in.); spinner handle; quick-clean/quick-release ratchet. 3/8-in. sq. drive: eight 12-pt. sockets (3/8 thru 1 3/16-in.); six 12-pt. deep sockets (3/8 thru 3/4-in.); spark plug socket (5/8-in.); extension bar (6-in.); quick-clean/quick-release ratchet. Separate prices total \$97.70.  
9 R 33710—Shpg. wt. 4 lbs. 10 oz. . . Set \$37.99

30-piece metric set includes 1/4-in. sq. drive: ten 6-pt. metric sockets (4 thru 13mm); extension bar (3-in.); spinner handle; quick-clean/quick-release ratchet. 3/8-in. sq. drive: six 6-pt. deep sockets (10, 12, 13, 14, 15, 17mm); eight 12-pt. sockets (10 thru 15, 17, 19mm); extension bar (6-in.); spark plug socket (5/8-in.); quick-clean/quick-release ratchet. Separate prices total \$99.70.  
9 R 33720—Shpg. wt. 4 lbs. 7 oz. . . Set \$37.99

†See page 148.

*you buy a lifetime of dependable service . . . WE GUARANTEE IT!\**

\*FULL UNLIMITED WARRANTY. If any CRAFTSMAN® Hand Tool ever fails to give complete satisfaction, simply return it to the nearest Sears store throughout the USA and Sears will replace it, free of charge. This warranty gives you specific legal rights and you may also have other rights which vary from state to state.

**105-PIECE CRAFTSMAN®**  
**Mechanics' Tool Set with**  
**STANDARD and METRIC tools**

- HERE'S WHAT YOU GET:
- 88 Sockets
  - 6 Wrenches
  - 5 Drive Tools
  - 6 Additional Tools



Tool Set (2) alone  
**Save 47%**  
**\$144<sup>99</sup>**

Tool Set (2) with Tool Chest  
**Save \$10 more**  
**\$158<sup>98</sup>**  
\$10 MONTHLY†

**59-PIECE CRAFTSMAN®**  
**Mechanics' Tool Set featuring**  
**our quick-clean/quick-release ratchet**

- HERE'S WHAT YOU GET:
- 53 Sockets
  - 6 Drive Tools



Tool Set (3) alone  
**Save 50%**  
**\$76<sup>99</sup>**

Tool Set (3) with Tool Chest  
**Save \$10 more**  
**\$90<sup>98</sup>**

**37-PIECE CRAFTSMAN®**  
**Mechanics' Tool Set featuring our**  
**quick-clean/quick-release ratchet**

- 31 Sockets
- 6 Drive Tools



Tool Set (4) alone  
**Save 50%**  
**\$47<sup>99</sup>**

**30-PIECE CRAFTSMAN®**  
**Mechanics' Tool Set featuring our**  
**quick-clean/quick-release ratchet**

- 24 Sockets
- 6 Drive Tools



Tool Set (5) alone  
**Save 50%**  
**\$37<sup>99</sup>**

You'll get the extra leverage you need to tackle the **BIG** jobs with these **CRAFTSMAN® Industrial-type Mechanics' Tool Sets**—**WARRANTED FOREVER!**

ONE QUALITY NAME

**CRAFTSMAN®**

OFFERS MORE GOOD CHOICES

Available only at Sears!

Lab tested for quality!

Made in the USA!

**225-PIECE STANDARD Set**  
with 1/4, 3/8 and 1/2-inch square drive sizes

HERE'S WHAT YOU GET:

- 94 Sockets
- 51 Wrenches
- 25 Drive Tools
- 55 Additional tools including 9 screwdrivers

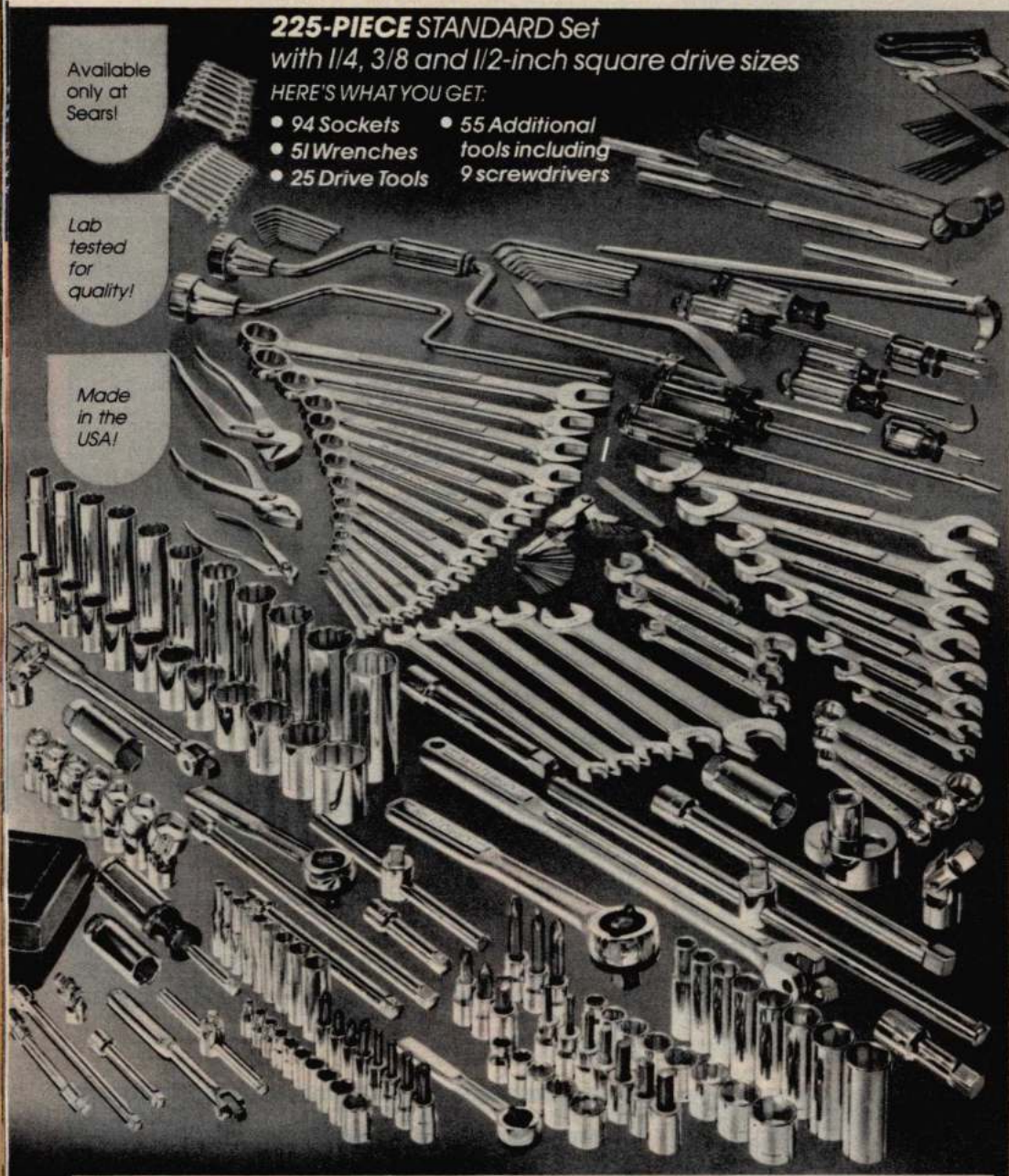

**1 and 2** Use these sets for big vehicle repair like trucks, buses, forklifts. Constructed from select steel chrome-plated to resist rust and corrosion. Ratchets have fine-tooth, quick-release features. Warranted by Sears, see below. Separate prices from pgs. 15 thru 26.

**1** \$18 monthly (see pg. 98). Set incl. 1/4-in. sq. drive: ten 6-pt. sockets (5/8 thru 1 1/2-in.); nine 6-pt. deep sockets (3/16 thru 1/2-in.); 2 Phillips bit sockets (no. 1, 2); 2 screwdriver bit sockets (.030, .039); 5 hex bit sockets (3/16 thru 3/8-in.); ratchet; flex "T" handle; 6-in. flex extension bar; 2 extension bars (3, 6 in.); spinner handle; universal joint; slide bar.

3/8-in. sq. drive: eight 6-pt. deep sockets (3/8 thru 1 3/16-in.); seven 6-pt. flex sockets (3/8 thru 3/4-in.); five 8-pt. sockets (1/4 thru 1/2-in.); eight 12-pt. sockets (3/8 thru 1 3/16-in.); two 6-pt. spark plug sockets (5/8, 1 3/16-in.); 3 screwdriver bit sockets (.030, .039, .055); 3 Phillips bit sockets (nos. 2, 3, 4); 6 hex bit sockets (5/32 thru 3/8-in.); ratchet; flex "T" handle; 3 extension bars (3, 6, 10-in.); speeder; slide bar; universal joint.

1/2-in. sq. drive: twelve 12-pt. sockets (7/16 thru 1 1/2 in.); eleven 12-pt. deep sockets (1/2 thru 1 1/2 in.); 6-pt. spark plug socket (1 3/16 in.); ratchet; flex "T" handle; 3 extension bars (3, 6, 10 in.); slide bar; speeder; stud extractor; universal joint.

**Wrenches:** 14 combination wrenches (1/4 thru 1 in.); 8 open-end wrenches (1/4 x 5/16 thru 1 1/2 x 1 1/2 in.); 3 flare-nut wrenches (3/8 x 7/16 thru 5/8 x 1 1/16 in.); 5 thin-head wrenches (3/8 x 7/16 thru 3/4 x 7/8 in.); 3 short box-end wrenches (3/8 x 7/16 thru 5/8 x 3/4 in.); 8-pc. open-end miniature wrench set; 10-pc. combination miniature wrench set.

**Additional tools:** 4 Phillips screwdrivers; 4 slotted screwdrivers; offset screwdriver; Arc Joint® pliers; slip-joint pliers; ignition pliers; brake adjusting tool; 5-pc. punch and chisel set; 20-pc. hex key set; ball-pein hammer; ignition gauge; ignition file; rolling wedge bar; cotter key extractor; hacksaw and 10 extra blades. Permanex® plastic case for 1/4-in. sq. drive tools. Separate prices total \$895.64.

9 R 46382C—Shpg. wt. 49 lbs. . . \$529.00

**Save \$10 more when you buy tool set (1) with tool chest (8) sold separately on p. 28. Separate prices total \$698.99.**

9 R 43962N—Shpg. wt. 102 lbs. . . \$688.99

**2** \$24 monthly. For big industrial-type fastening and turning jobs, we added 3/4-in. sq. drive tools to this 246-pc. set. Set incl. all pieces in Set (1) and 3/4-in. sq. drive: seventeen 12-pt. sockets (7/8 thru 2 in.); standard quick-release ratchet; 18-in. flex "T" handle; 2 extension bars (5, 8 in.). Separate prices total \$1159.43.

9 R 43687C—Shpg. wt. 73 lbs. . . \$699.00

**Save \$37 more when you buy tool set (2) with tool chest (8) sold separately on p. 28. Separate prices total \$868.99.**

9 R 43745N—Shpg. wt. 126 lbs. . . \$831.99

**246-PIECE set**  
incl. all 225 pieces  
in set (1) and  
more!

**PLUS**  
3/4-in. sq.  
drive tools

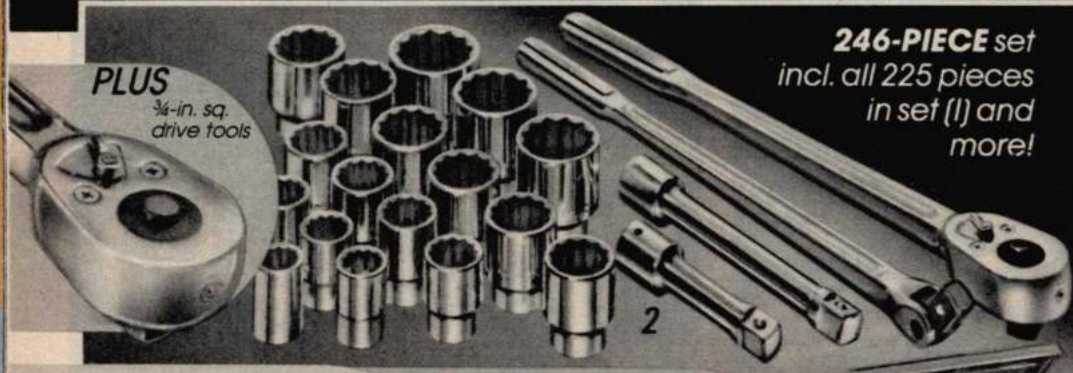

Tool Sets alone

225-pc. Set **Save \$529 40%**

246-pc. Set **Save \$699 39%**

Tool Sets with Tool Chest at right

225-pc. Set **\$688.99** \$23 MO., see p. 148

246-pc. Set **\$831.99** \$28 MONTHLY, see page 148

**Save \$10 to \$37 more**



**FULL UNLIMITED WARRANTY**  
If any CRAFTSMAN® Hand Tool ever fails to give complete satisfaction, simply return it to the nearest Sears store throughout the USA and Sears will replace it, free of charge. This warranty gives you specific legal rights and you may also have other rights which vary from state to state.

# CRAFTSMAN® ratchet customers drive a hard bargain!

They not only demand quality and value, they're always looking for a faster, easier, better way to do things. That's why we're now offering this Sears exclusive quick-clean/quick-release ratchet. It makes ratchet maintenance as easy as 1, 2, 3!

1. Release. Press center button down firmly, turn ratchet over and drop out core mechanism

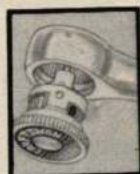

2. Clean. Use dry or with light oil to lubricate

3. Reassemble. Insert core, rotate slightly to seat and push small button on bottom to lock

Quick-clean/quick-release ratchet

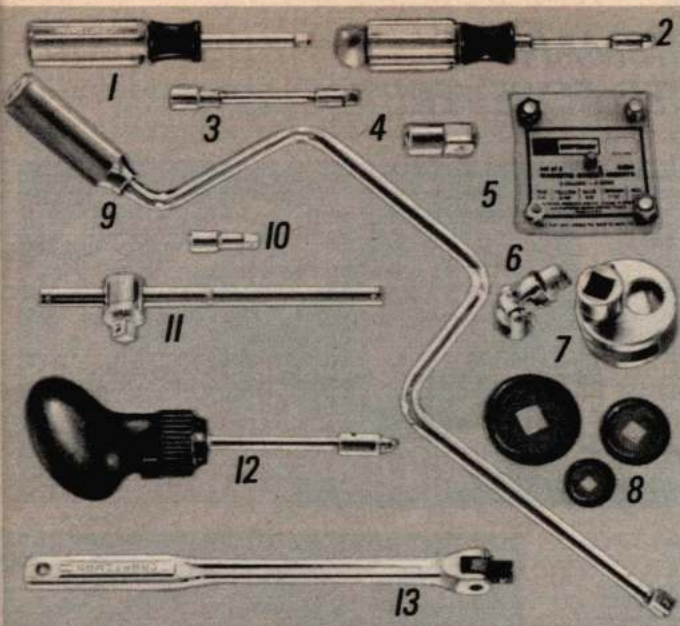
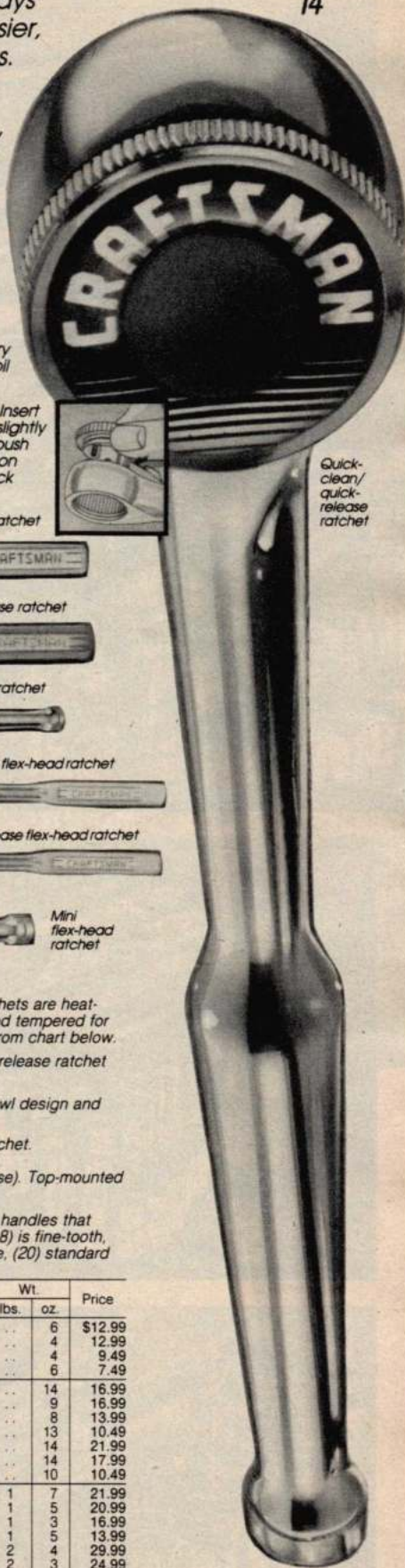

## Ratchet accessories

**Save \$2** on matching U-joint (6) when you also buy any ratchet on this page

1 thru 13 Our CRAFTSMAN drive tool accessories are made of select steel that is heat-treated, oil-quenched and tempered for strength. Nickel-chrome plating resists rust. Impact accessories have black oxide finish. See warranty\* below.

1 Spinner handles for use with sockets for light tightening. 1/4-in. square drive. Plastic handles.  
9 R 43372—6 in. Wt. 3 oz. . . \$5.59  
9 R 43351—4 1/2 in. Wt. 5 oz. . . \$4.69

2 6-in. flex spinner for 1/4-in. sq. dr. sockets, fittings. Flexible steel spring shaft. Plastic handle.  
9 R 4355—Wt. 5 oz. . . \$7.69

3 Flex extension has a flexible steel spring shaft. 1/4-in. square drive. 4 in. long.  
9 R 4336—Wt. 3 oz. . . \$5.79

4 Socket adapters allow sockets of one drive size to fit drive tools of another size.

Drive size	Converts to	Catalog Number	Shpg. wt.	Each
1/4 in.	3/8 in.	9 R 4257	1 oz.	\$3.19
3/8 in.	1/2 in.	9 R 4256	1 oz.	3.19
3/8 in.	1/2 in.	9 R 4258	1 oz.	3.19
1/2 in.	3/4 in.	9 R 4259	1 oz.	4.19
1/2 in.	3/4 in.	9 R 4271	3 oz.	5.29

5 1/2-in. sq. drive. Double-end socket (shown on page 49). 6-pt., 3/4-in. opening at one end, 6-pt., 13/16-in. opening at other. For 1/2-in. square drive impact tools with extended shank. Imported.

9 R 18958—Shpg. wt. 7 oz. . . \$4.49

6 Impact universal joints (shown on page 49). 3/8-in. Imported.

9 R 18955—Shpg. wt. 2 oz. . . \$7.49

7 Impact socket adapter (shown on page 49). 1/2-in. sq. drive converts to 3/8-in. Imported.

9 R 18961—Shpg. wt. 3 oz. . . \$5.49

8 5-piece magnetic insert set holds nut in socket. Incl. 1/4, 5/16, 3/8, 7/16, 1/2-in. inserts. Storage pouch.  
9 R 4404—Wt. 1 oz. . . Set \$3.19

9 Universal joints swing 90°.

Size in.	Catalog No.	Wt.	Alone	Each**
1/4	9 R 4280	1 oz.	\$6.29	\$4.29
3/8	9 R 4435	2 oz.	7.29	5.29
1/2	9 R 4425	4 oz.	8.49	6.49

\*\*When you also buy any ratchet (14 thru 20).

10 Stud remover. 1/2 in. square drive. Use to remove broken bolts and studs. 3/8 to 3/4 in. capacity.  
9 R 4458—Wt. 14 oz. . . \$15.99

8 Ratchet speeder discs are made of rust-resistant steel. Fit between ratchet and socket. Set of 3 for 1/4, 3/8, 1/2-in. drive ratchets. Includes vinyl storage pouch.  
9 R 44191—Wt. 4 oz. . . Set \$4.39

## 9 Speeder wrenches

Sq. drive	Lgth. in.	Catalog Number	Wt.		Each
			lbs.	oz.	
1/4 in.	15 1/2	9 R 4281	10	10	\$9.69
3/8 in.	16	9 R 44271	1	1	12.29
1/2 in.	18	9 R 44161	1	13	13.79

## 10 Extension bars

Sq. dr.	Lgth. in.	Catalog Number	Wt.		Each
			lbs.	oz.	
1/4 in.	1 1/2	9 R 43538	3	3	\$3.29
	3	9 R 43539	3	3	3.69
	6	9 R 43531	4	4	4.19
	14	9 R 43532	5	8	2.29
3/8 in.	1 1/2	9 R 43537	4	3	3.69
	3	9 R 44264	2	4	4.19
	6	9 R 44261	6	5	5.09
	10	9 R 44262	9	7	7.09
1/2 in.	2	9 R 44263	13	10	10.59
	2	9 R 43522	6	4	4.29
	3	9 R 44133	6	6	4.69
	6	9 R 44131	8	6	6.09
3/4 in.	10	9 R 44132	15	8	8.09
	20	9 R 44134	1	4	11.49
	5	9 R 4440	15	12	12.99
	8	9 R 4441	1	7	14.99
1 1/2 in.	16	9 R 4442	2	10	22.99

11 Slide bar handles. Use as "T" or "L" handle to loosen fasteners.

Sq. drive	Lgth. in.	Catalog Number	Wt.		Each
			lbs.	oz.	
1/4 in.	4 1/4	9 R 4354	4	4	\$6.49
3/8 in.	7	9 R 4428	10	7	7.49
1/2 in.	9	9 R 44152	13	8	8.49
3/4 in.	15	9 R 44151	1	6	10.69
1 1/2 in.	18	9 R 4443	4	4	15.99

12 Wrist ratchet for use with 1/4-in. drive sockets and tools, includes bit adapter, high-torque handle, all-metal ratchet mechanism and fingertip speeder.  
9 R 43801—Wt. 8 oz. . . \$8.69

13 Flex handles. Hinged-joint. Positive stops at 0 and 45°.

Square drive	Lgth. in.	Catalog Number	Wt.		Each
			lbs.	oz.	
1/4 in.	6	9 R 43523	4	5	\$7.79
3/8 in.	10	9 R 44363	10	10	10.29
1/2 in.	15	9 R 44201	1	8	15.99
3/4 in.	18	9 R 44202	1	12	18.99
1 1/2 in.	18	9 R 4431	3	1	29.99

\*FULL UNLIMITED WARRANTY  
If any CRAFTSMAN® hand tool ever fails to give complete satisfaction, simply return it to the nearest Sears store throughout the USA and Sears will replace it, free of charge. This warranty gives you specific legal rights and you may also have other rights which vary from state to state.

15 Fine-tooth ratchet

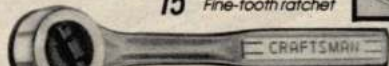

16 Quick-release ratchet



17 Standard ratchet

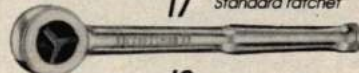

18 Fine-tooth flex-head ratchet

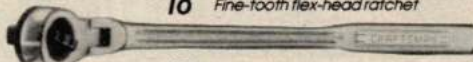

19 Quick-release flex-head ratchet

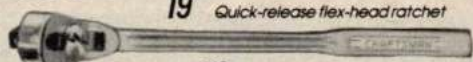

20 Mini flex-head ratchet



14 thru 20 ALL CRAFTSMAN® ratchets are heat-treated, oil-quenched and tempered for strength. Warranted forever\*. Order from chart below.

14 Our exclusive quick-clean/quick-release ratchet allows for easy maintenance.

15 Fine-tooth ratchet has double-pawl design and built-in knurled speeder.

16 Quick-release standard tooth ratchet.

17 Standard ratchet (no quick-release). Top-mounted knurled speeder.

18 thru 20 Flex-head ratchets with handles that adjust from 0° to 90°. (18) is fine-tooth, (19) standard tooth with quick-release, (20) standard mini-flex (with no quick-release).

Square Drive	Item Key	Length (inches)	Catalog Number	Wt.		Price
				lbs.	oz.	
1/4-in.	(14)	5 1/4	9 R 43771	6	6	\$12.99
	(15)	5 1/4	9 R 43187	4	4	12.99
	(16)	5 1/4	9 R 43185	4	4	9.49
	(17)	5 1/2	9 R 43796	6	7	7.49
	(18)	5 1/2	9 R 43772	14	16	16.99
3/8-in.	(14)	8	9 R 43772	14	16	16.99
	(15)	6 7/8	9 R 43781	9	9	16.99
	(16)	6 7/8	9 R 43784	8	8	13.99
	(17)	7 3/4	9 R 43796	13	10	10.49
	(18)	11	9 R 42794	14	21	21.99
	(19)	11 1/4	9 R 42793	14	17	17.99
1/2-in.	(20)	6	9 R 4378	10	10	10.49
	(14)	10	9 R 43773	1	7	21.99
	(15)	10 3/8	9 R 44977	1	5	20.99
	(16)	10 3/8	9 R 44985	1	3	16.99
	(17)	9 3/4	9 R 43797	1	5	13.99
3/4-in.	(18)	16 1/2	9 R 44983	2	4	29.99
	(19)	16 1/2	9 R 44984	2	3	24.99
	(16)	19 3/4	9 R 44804	5	1	49.99
	(†)	20	9 R 4375	4	5	39.99

†Not shown

**Built to take the pressure . . . CRAFTSMAN®  
Socket Wrench Sets are WARRANTED FOREVER!**

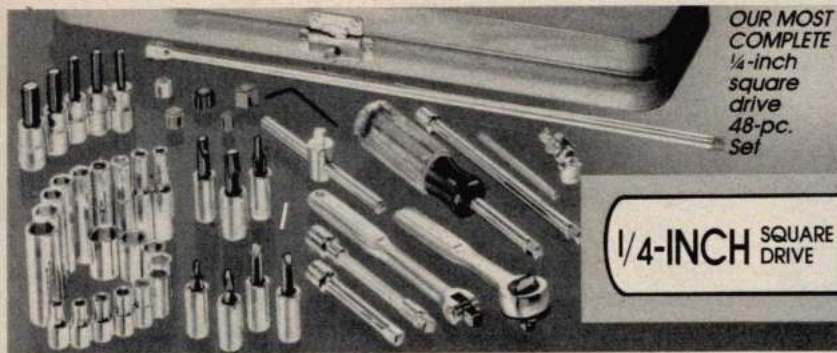

OUR MOST COMPLETE  
1/4-inch square drive  
48-pc. Set

**1/4-INCH SQUARE DRIVE**

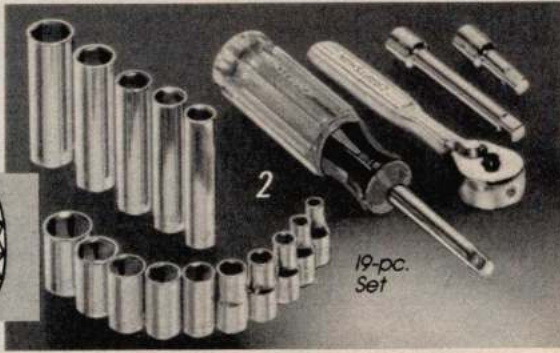

2

19-pc. Set

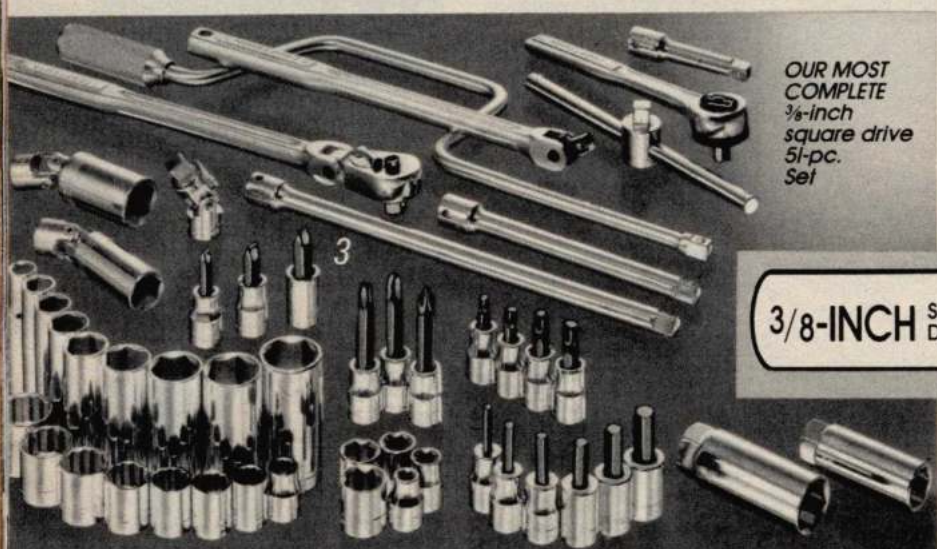

OUR MOST COMPLETE  
3/8-inch square drive  
51-pc. Set

**3/8-INCH SQUARE DRIVE**



4

25-pc. Set



5

19-pc. Set

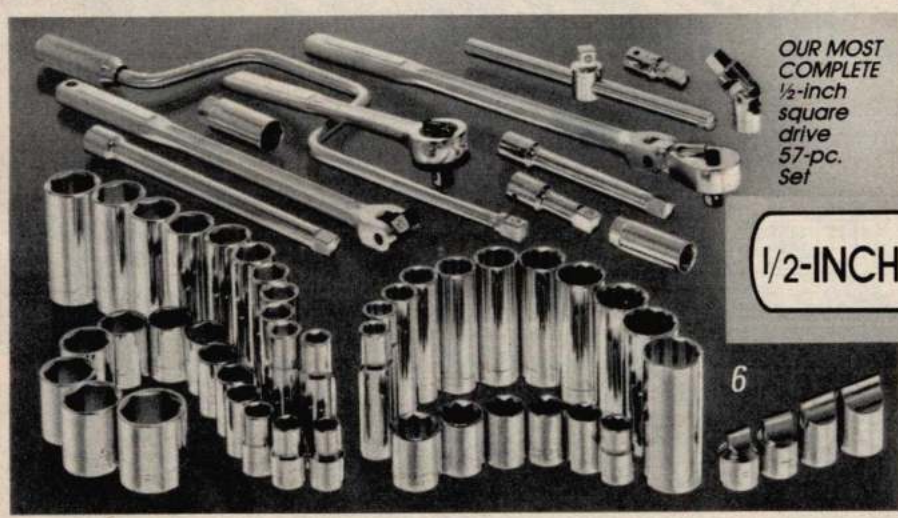

OUR MOST COMPLETE  
1/2-inch square drive  
57-pc. Set

**1/2-INCH SQUARE DRIVE**



7

22-pc. Set



8

14-pc. Set

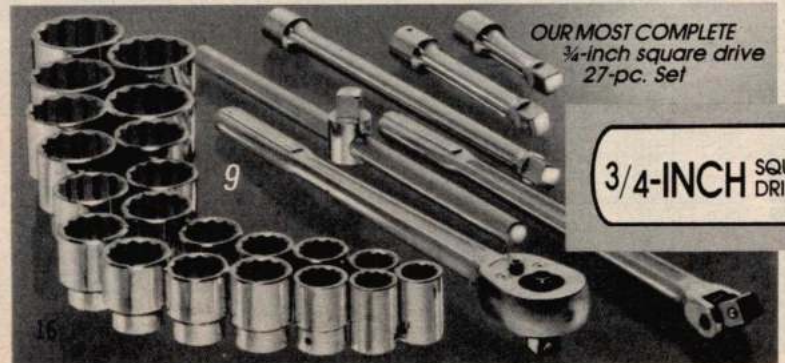

OUR MOST COMPLETE  
3/4-inch square drive  
27-pc. Set

**3/4-INCH SQUARE DRIVE**

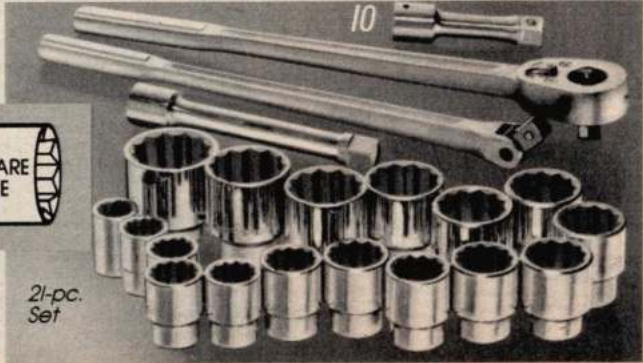

10

21-pc. Set

# Go METRIC with CRAFTSMAN Accessory Sets!

**Save 41%**  
over regular  
separate prices

**1 thru 10** All items (except 2, 5, 8) are available at Sears only in catalog!  
These sockets, ratchets and accessories are made of a select steel, heat-treated for extra strength, then oil-quenched and tempered for "through-hardening" so there are no inner soft spots. Nickel-chrome plating adds rust resistance. 1/4, 3/8, and 1/2-in. sq. drive CRAFTSMAN sockets have thin sidewall construction to allow work in limited space. Even with this thinwall construction, the sockets maintain the strength necessary to do heavy work without breaking or failing. See warranty on page 4.

## 1/4-inch square drive sets

Tool	(1) 48-pc. standard set	(2) 19-pc. standard set	(2) 19-pc. metric set
6-pt. Socket	10 (5/8 thru 1 1/2 in.)	10 (5/8 thru 1 1/2)	10 (4 thru 13mm)
6-pt. deep Socket	9 (7/16 thru 1 1/2 in.)	5 (5/8 thru 1 1/2)	5 (8 thru 12mm)
Screwdriver bit Socket	2 slotted, 2 Phillips		
Hex bit Socket	5 (7/16, 7/32, 1/4, 9/16, 5/8)		
Clutch bit Socket	3 (5/32, 1/4, 9/16)		
Quick-release Ratchet	fine-tooth	standard	standard
Extension bar	3 (3, 6, 14 in.)	2 (1 1/2, 3 in.)	2 (1 1/2, 3 in.)
Flex extension	4 in.		
Flex "T" handle	6 in.		
Universal joint	one		
Spinner handle	6 in.	6 in.	6 in.
Cross bar	one		
Slide bar	4 1/2 in.		
Short hex key	5/64		
Magnetic insert	5 (1/4 to 1/2 in.)		
Storage case	Metal		
Catalog Number	9 R 44392	9 R 34701	9 R 34702
Shipping weight	4 lbs. 11 oz.	1 lb. 6 oz.	1 lb. 6 oz.
Price	\$94.99	\$18.99	\$18.99

## 3/8-inch square drive sets

Tool	(3) 51-pc. standard set	(4) 25-pc. standard set	(5) 19-pc. standard set	(5) 19-pc. metric set
6-pt. deep Socket	9 (5/8 thru 1 1/2 in.)	9 (5/8 thru 1 1/2 in.)	8 (5/8 thru 1 1/2 in.)	8 (9, 10, 12 thru 17mm)
8-pt. Socket	5 (1/2 thru 1 1/2 in.)			
12-pt. Socket	8 (5/8 thru 1 1/2 in.)	8 (5/8 thru 1 1/2 in.)	8 (5/8 thru 1 1/2 in.)	8 (9 thru 16mm)
Screwdriver bit Socket	3 slotted, 3 Phillips			
Hex bit Socket	6 (7/16 thru 1/2 in.)			
Torx bit Socket	4 (T30, T40, T45, T50)			
6-pt. Spark plug socket	2 (5/8, 1 1/2 in.)	2 (5/8, 1 1/2 in.)	1/2 in.	1/2 in.
6-pt. Flex spark plug socket	2 (5/8, 1 1/2 in.)			
Quick-release Ratchet	2 (fine-tooth, flex-head)	fine-tooth	standard	standard
Extension bar	3 (3, 6, 10 in.)	3 (3, 6, 10 in.)	3 in.	3 in.
Flex "T" handle	10 in.			
Universal joint	One	One		
Speeder, Slide bar	One each			
Storage		Plastic		
Catalog Number	9 R 44047	9 R 44046	9 R 34708	9 R 34709
Shipping weight	11 lbs. 2 oz.	5 lbs.	3 lbs. 2 oz.	2 lbs. 10 oz.
Price	\$149.00	\$49.99	\$27.99	\$27.99

## 1/2-inch square drive sets

Tool	(6) 57-pc. standard set	(7) 22-pc. standard set	(8) 14-pc. standard set
6-pt. Socket	13 (7/8 thru 1 1/2 in.)		
6-pt. deep Socket	11 (1/2 thru 1 1/2 in.)		
8-pt. Socket	6 (7/8 thru 1 1/2 in.)		
12-pt. Socket		10 (7/8 thru 1 in.)	11 (7/8 thru 1 1/2 in.)
12-pt. deep Socket	11 (1/2 thru 1 1/2 in.)	8 (1/2 thru 1 1/2 in.)	
Drag link Socket	4 (7/8 thru 1 1/2 in.)		
6-pt. Spark plug Socket	2 (5/8, 1 1/2 in.)		1 1/2 in.
Quick-release Ratchet	2 (fine-tooth, flex head)	Standard	Standard
Extension bar	4 (2, 3, 6, 10 in.)	2 (3, 6 in.)	3 in.
Flex "T" handle	15 in.		
Universal joint	One		
Speeder, Slide bar	One each		
Storage case		Plastic	
Catalog Number	9 R 44077C	9 R 44074	9 R 34712
Shipping weight	25 lbs.	7 lbs. 10 oz.	4 lbs. 5 oz.
Price	\$199.00	\$49.99	\$27.99

## 3/4-inch square drive sets

Tool type	(9) 27-piece std. set	(10) 21-piece std. set
12-pt. Socket	Twenty-one (7/8 thru 2 1/2 in.)	Seventeen (7/8 thru 2 in.)
Quick-release Ratchet	Standard	Standard
Extension bar	Three (5, 8, 16 inches)	Two (5, 8 in.)
Flex "T" handle	18 in.	18 in.
Slide bar	18 in.	
Catalog Number	9 R 46305C	9 R 46308C
Shipping weight	38 pounds	24 pounds
Price	\$299.99	\$199.00

**Combination of  
OUR MOST COMPLETE SETS (1, 3 and 6) \$399**

You get a total of 156 pieces in 1/4, 3/8 and 1/2-inch square drive sizes. See charts above for complete list.  
9 R 44078C—Shipping weight 40 pounds... Set \$399.00

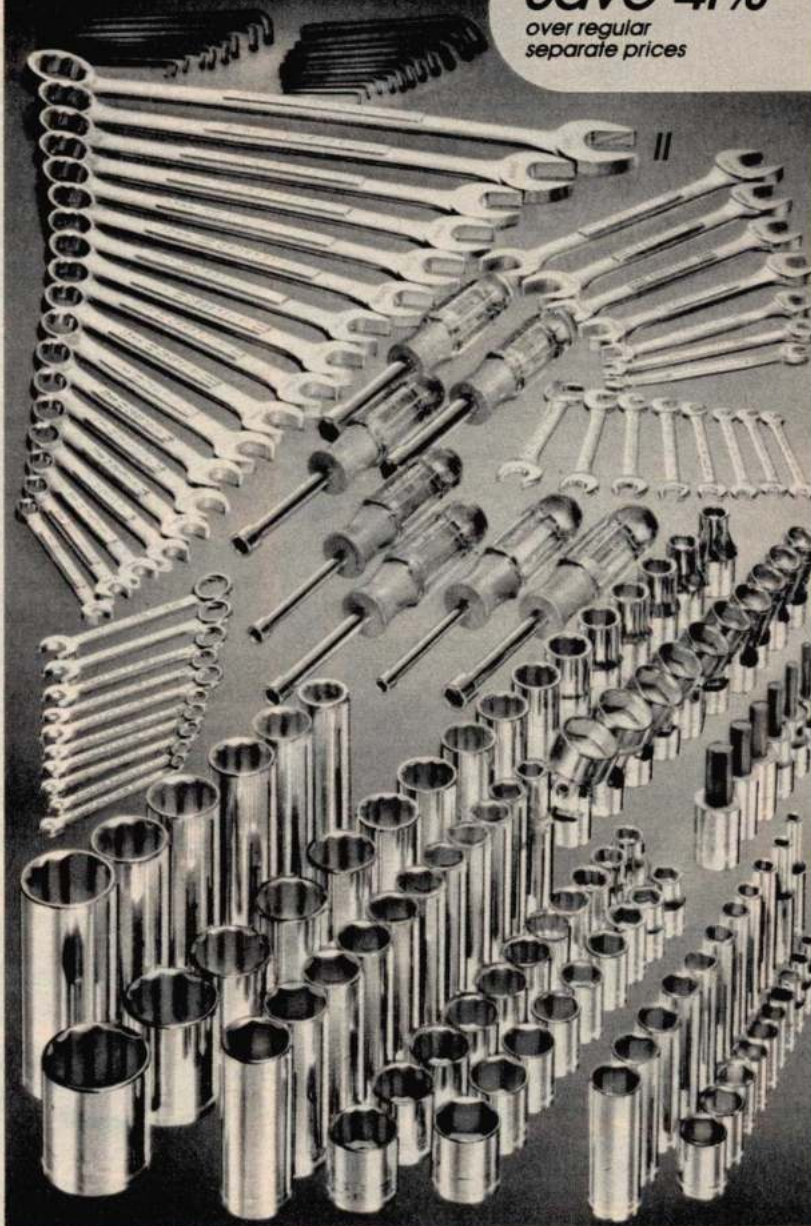

Available at Sears only in catalog! Same construction as our Socket Wrench Sets at left. See warranty on p. 4. Items are sold separately on pgs. 18 thru 24.

Tool	(11) 160-pc. Set	109-pc. set (not shown)	54-pc. set (not shown)
1/4-in. sq. drive 6-pt. sockets	10 (4 thru 13mm)	10 (4 thru 13mm)	6 (5 thru 10mm)
1/4-in. sq. drive 6-pt. deep sockets	11 (4 thru 14mm)	11 (4 thru 14mm)	5 (7 thru 11mm)
3/8-in. sq. drive 6-pt. sockets	9 (9 thru 15, 17, 19mm)		
3/8-in. sq. drive 6-pt. deep sockets	11 (9 thru 19mm)	11 (9 thru 19mm)	8 (10, 12 thru 18mm)
3/8-in. sq. drive 6-pt. flex sockets	10 (10 thru 19mm)		
3/8-in. sq. drive 12-pt. sockets	11 (9 thru 19mm)	11 (9 thru 19mm)	11 (9 thru 19mm)
3/8-in. sq. drive hex bit sockets	6 (4 thru 8, 10mm)		
1/2-in. sq. drive 12-pt. sockets	16 (9 thru 19, 21, 22, 24, 27, 30mm)	16 (9 thru 19, 21, 22, 24, 27, 30mm)	12 (10 thru 19, 22, 24mm)
1/2-in. sq. drive 12-pt. deep sockets	6 (14, 17, 19, 21, 22, 27mm)	6 (14, 17, 19, 21, 22, 27mm)	
Wrenches-Combination	18 (7 thru 22, 24, 27mm)	17 (7 thru 22, 24mm)	12 (7, 10 thru 19, 22mm)
Open End	7 (8x8, 7x9, 10x11, 12x14, 13x15, 16x18, 17x19mm)	5 (10x11, 12x14, 13x15, 16x18, 17x19mm)	
Combination miniature	10 (4x4.5 thru 10x11mm)		
Open End miniature			
Nutdrivers	8 (5 thru 11mm)	8 (5 thru 11mm)	
Hex Key	7 (5 thru 11mm)		
	20-piece set	14-piece set	
Catalog Number	9 R 33053C	9 R 33051C	9 R 33138
Shipping weight	23 pounds	17 pounds	8 lbs. 11 oz.
Separate prices total	\$511.45	\$342.61	\$179.96
Price Set	\$299.00	\$199.00	\$104.99

# Tighten it with CRAFTSMAN confidence . . .

Combination Wrench

## (1) Combination Wrenches

### STANDARD sizes

Size in.	Lgth. in.	Catalog Number	Wt.		Each
			lbs.	oz.	
1/4	3 1/16	9 R 44689	3	3	\$3.39
9/16	4 1/8	9 R 44691	3	3	3.39
1 1/32	4 7/16	9 R 44692	3	3	3.89
5/8	5 1/4	9 R 44693	3	3	3.89
7/8	5 7/8	9 R 44694	4	3	3.89
1 1/2	6 1/2	9 R 44695	5	5	5.19
9/8	7 1/8	9 R 44696	5	5	5.19
5/8	8	9 R 44697	7	5	5.19
1 1/16	8 5/16	9 R 44698	7	5	5.69
3/4	9	9 R 44701	9	6	6.19
1 3/16	10 1/8	9 R 44702	10	6	6.59
7/8	11 1/2	9 R 44703	11	7	7.09
1 3/16	12 1/2	9 R 44704	12	8	8.99
1 1/2	13 1/2	9 R 44705	1	9	9.29
1 1/16	14 1/8	9 R 44706	1	5	11.99
1 3/8	15 1/8	9 R 44707	1	5	18.49
1 1/4	16 1/8	9 R 44708	1	12	18.99
1 5/16	18 1/8	9 R 44709	1	15	19.49

### METRIC sizes

Size mm	Lgth. in.	Catalog Number	Wt.		Each
			lbs.	oz.	
6	3 3/16	9 R 42909	3	3	\$3.39
7	3 3/8	9 R 42911	3	3	3.39
8	4 1/8	9 R 42912	3	3	3.49
9	4 1/4	9 R 42913	3	3	3.39
10	4 3/8	9 R 42914	3	3	3.39
11	5 1/8	9 R 42915	4	3	4.39
12	5 3/8	9 R 42916	4	3	4.39
13	6 1/8	9 R 42917	5	3	5.19
14	6 3/8	9 R 42918	5	3	5.19
15	7 1/8	9 R 42919	7	3	5.49
16	8	9 R 42924	7	5	5.49
17	8 3/8	9 R 42929	7	6	6.09
18	8 3/4	9 R 42925	8	6	6.09
19	9 1/2	9 R 42921	9	6	6.79
20	10 1/4	9 R 42937	8	6	6.79
21	10 1/8	9 R 42938	9	8	8.49
22	11 1/8	9 R 42922	11	8	8.49
23	12 1/8	9 R 42939	15	9	9.29
24	12 1/4	9 R 42923	14	10	10.49
25	13 1/2	9 R 42931	1	2	10.99
26	14 1/8	9 R 42932	1	4	11.49
27	14 1/4	9 R 42933	1	7	12.99
28	15 3/8	9 R 42934	1	11	13.49
30	16 1/4	9 R 42935	1	11	16.29
32	16 1/2	9 R 42936	1	13	16.49

## (2) Box-end Wrenches

### STANDARD sizes

Size in.	Lgth. in.	Catalog Number	Wt.		Each
			lbs.	oz.	
3/8x7/16	4 1/4	9 R 43866	1	1	\$5.99
1/2x9/16	5 1/2	9 R 43864	1	5	5.99
5/8x1 1/8	6 1/8	9 R 43865	3	3	5.99
3/4x1 1/4	7 1/8	9 R 43919	3	4	4.79
7/8x1 3/8	7 3/4	9 R 43922	4	4	4.99
1x1 1/2	8 1/2	9 R 43921	5	5	4.99
1 1/8x1 7/8	9 1/8	9 R 43923	5	5	5.99
1 1/4x2	9 3/4	9 R 43924	6	5	5.99
1 1/2x2 1/4	10	9 R 43925	7	6	6.99
1 3/4x2 3/4	10 1/2	9 R 43926	7	6	6.99
1 7/8x3	11 1/8	9 R 43927	8	7	7.99
2x3 1/4	12 1/8	9 R 43928	10	9	9.99
2 1/8x4	15 1/8	9 R 43929	13	9	9.99
1 1/2x1 1/4	17 1/8	9 R 43934	1	10	16.49
1 1/2x1 1/2	18 1/8	9 R 43935	2	2	17.99
1 7/8x1 3/4	22 3/8	9 R 43936	2	8	22.99

### METRIC sizes

Size mm	Lgth. in.	Catalog Number	Wt.		Each
			lbs.	oz.	
6x8	7	9 R 42952	3	4	\$4.69
7x9	7 3/4	9 R 42953	4	4	4.69
10x11	7 7/8	9 R 42954	4	5	6.69
12x14	9 1/4	9 R 42956	5	5	6.69
13x15	9 1/8	9 R 42957	6	6	6.29
16x18	10 1/2	9 R 42961	8	7	6.69
17x19	11 1/8	9 R 42958	8	8	7.29
20x22	11 3/8	9 R 42965	13	8	8.49
21x23	12 1/8	9 R 42966	14	9	9.69
22x24	13 1/8	9 R 42959	13	9	9.69
24x26	14 1/4	9 R 44962	15	9	9.69
25x28	14 3/8	9 R 44963	1	1	13.69
27x30	15 3/8	9 R 44965	1	4	14.29
28x33	16 1/8	9 R 44966	1	7	19.69
30x32	17	9 R 44967	1	8	19.99

## (3) Open-end Wrenches

### STANDARD sizes

Size in.	Lgth. in.	Catalog Number	Wt.		Each
			lbs.	oz.	
3/8x7/16	4 1/4	9 R 44571	3	3	\$3.79
1/2x9/16	5 1/8	9 R 44572	2	3	3.79
5/8x1 1/8	6 1/8	9 R 44579	5	4	4.99
3/4x1 1/4	7	9 R 44582	7	5	5.29
7/8x1 3/8	7 1/8	9 R 44581	7	5	5.29
1x1 1/2	8 1/8	9 R 44582	8	7	5.99
1 1/8x2	9 1/8	9 R 44591	10	5	5.99
1 1/4x2 1/4	9 3/8	9 R 44584	10	8	8.69
1 3/8x3	10	9 R 44585	10	6	8.29
1 7/8x3 1/4	10 1/2	9 R 44583	14	8	8.69
1 1/2x1 1/4	12	9 R 44586	1	2	11.29
1 1/2x1 1/2	14 1/8	9 R 44587	2	2	18.49
1 1/2x1 3/4	16 1/8	9 R 44588	2	2	22.99
1 7/8x1 3/4	17 1/8	9 R 44589	2	14	23.99

### METRIC sizes

Size mm	Lgth. in.	Catalog Number	Wt.		Each
			lbs.	oz.	
6x8	4 1/2	9 R 44502	3	3	\$3.79
7x9	5	9 R 44503	4	3	3.79
10x11	5 1/8	9 R 44504	4	4	4.79
12x14	6 1/8	9 R 44506	5	5	5.49
13x15	7	9 R 44507	6	5	5.49
16x18	7 3/4	9 R 44521	7	6	6.49
17x19	8 1/8	9 R 44508	8	6	6.49
20x22	9 1/2	9 R 44522	11	7	7.49
21x23	10 1/8	9 R 44523	15	7	7.99
22x24	10 3/8	9 R 44509	13	8	8.99
24x26	11 1/8	9 R 44515	1	9	9.49
25x27	11 3/8	9 R 44516	1	2	9.99
28x30	12 1/8	9 R 44518	1	5	11.99
30x32	13 1/2	9 R 44519	1	11	16.99

\*Available at Sears in catalog only!

FULL UNLIMITED WARRANTY ON CRAFTSMAN HAND TOOLS: If any Craftsman Hand Tool ever fails to give complete satisfaction, return it to the nearest Sears store in the U.S. and Sears will replace it, free of charge. This warranty gives you specific legal rights, and you may also have other rights which vary from state to state.

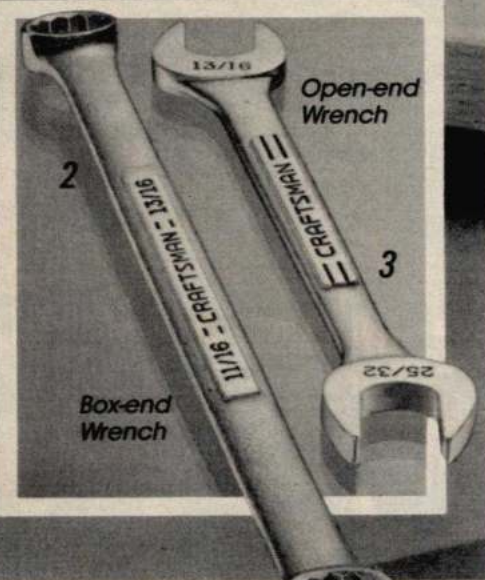

Why are we so confident about CRAFTSMAN® Wrenches?

Because they're:

- ✓ Constructed from a select steel chosen for its unique resistance to brittleness
- ✓ Forged for increased strength
- ✓ Heat-treated, oil-quenched and tempered to uniformly "through-harden" them, which eliminates inner soft spots
- ✓ Nickel-chrome plated for rust and corrosion resistance. Matte finish helps provide firm grip. Sizes are stamped on each wrench for easy identification

SearsCharge and Discover Card... each is different, but together they're all you really need

To apply for SearsCharge only CALL TOLL FREE 1-800-323-3274 IN ILLINOIS CALL 1-800-942-7446

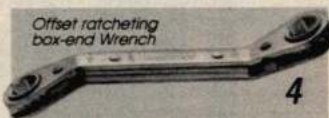

Offset ratcheting box-end Wrench

4

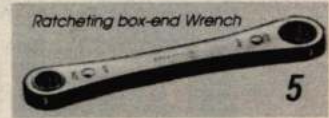

Ratcheting box-end Wrench

5

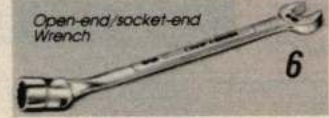

Open-end/socket-end Wrench

6

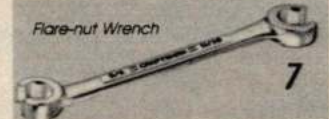

Flare-nut Wrench

7

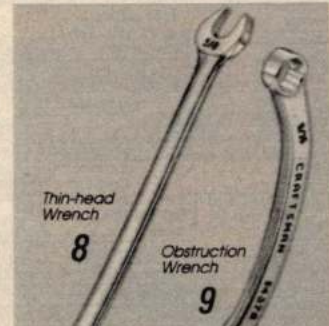

Thin-head Wrench

Obstruction Wrench

8

9

## (4 thru 9) CRAFTSMAN® Specialty Wrenches

4 Individual Ratcheting Box-end 25° Offset Wrenches. 6-pt. openings.

### STANDARD sizes

Size in.	Catalog Number	Wt. oz.	Each
1/4x7/16	9 R 43651	2	\$5.49
3/8x7/16	9 R 43652	3	5.99
1/2x9/16	9 R 43653	6	6.59
5/8x1 1/8	9 R 43654	10	7.79
3/4x1 1/4	9 R 43655	12	8.39

### METRIC sizes

Size mm	Catalog Number	Wt. oz.	Each
7x8	9 R 43661	2	\$5.49
9x10	9 R 43662	3	5.99
11x12	9 R 43663	6	6.59
13x14	9 R 43664	6	7.79
15x17	9 R 43665	10	8.39

5 Individual Ratcheting Box-end Wrenches. 12 pt. openings.

### STANDARD sizes

Size in.	Lgth. in.	Catalog Number	Wt. oz.	Each
1/4x9/16	4 1/4	9 R 43681	2	\$4.49
3/8x9/16	5 1/8	9 R 43682	6	4.99
1/2x9/16	6 1/8	9 R 43683	8	5.49
5/8x1 1/8	7 1/8	9 R 43684	10	6.49
3/4x1 1/4	8 1/8	9 R 43685	13	6.99

### METRIC sizes

Size mm	Lgth. in.	Catalog Number	Wt. oz.	Each
6x8	4 1/4	9 R 43691	3	\$4.49
10x11	5 1/8	9 R 43692	5	4.99
12x13	6 1/8	9 R 43693	8	5.49
14x16	7 1/8	9 R 43694	10	6.49
17x19	8 1/8	9 R 43695	14	6.99

\* Available at Sears in catalog only!   
▲ 12 pt. openings

6 Individual STANDARD Open-end/Socket-end Wrenches.

Size in.	Lgth. in.	Catalog Number	Wt. oz.	Each
3/8"	7 1/8	9 R 42544	5	\$9.49
7/8"	7 1/8	9 R 42541	5	10.99
1/2"	8 1/8	9 R 42542	7	10.99
5/8"	8 3/8	9 R 42543	7	10.99
9/8"	9 1/8	9 R 42545	9	11.79
1 1/16"	9 3/8	9 R 42547	10	11.79
3/4"	10 3/8	9 R 42546	11	11.79

7 Individual Flare-nut Wrenches.

Size in.	Lgth. in.	Catalog Number	Wt. oz.	Price
3/8x7/16	6	9 R 44174	4	\$8.49
1/2x9/16	6 1/8	9 R 44171	5	8.49
5/8x1 1/8	8 1/8	9 R 44173	8	8.99

### METRIC sizes

Size mm	Lgth. in.	Catalog Number	Wt. oz.	Each
9x11	6	9 R 44175	4	\$7.99
10x12	6 1/8	9 R 44176	5	7.99
13x14	7	9 R 44177	5	7.99
15x17	7 1/8	9 R 44178	8	7.99
19x21	8	9 R 44179	9	7.99

8 Individual STANDARD Thin-head Wrenches. For adjusting tappets.

Size in.	Catalog Number	Wt. oz.	Price
3/8x7/16	9 R 44475	5	\$6.99
7/8x1 1/8	9 R 44471	5	6.99
1/2x9/16	9 R 44472	6	6.99
5/8x1 1/8	9 R 44473	7	6.99
3/4x7/8	9 R 44474	8	7.49

9 STANDARD Obstruction wrench. Use in confined areas, starters, manifolds. 12-pt. openings, 3/8" and 7/8" in. long. 9 R 4376—Wt. 7 oz. \$10.49

because if any CRAFTSMAN® Wrench ever breaks or fails to give you complete satisfaction, we'll replace it free of charge\*!

Save 19% to 50% when you buy wrench sets (10, 11, 15, 16 and 18 thru 21)



**(10) Combination Wrench Sets**

17-pc. STANDARD Set incl. 1/4 thru 1 1/4-in. sizes. Sep. prices total \$127.33 on p. 18.  
9 R 49661—Shpg. wt. 9 lbs. 6 oz. . . . Set \$64.99

17-pc. METRIC Set incl. sizes 7 thru 19mm, 21, 22, 24 and 27mm. Sep. prices total \$106.03, p. 18.  
9 R 49671—Shpg. wt. 5 lbs. 10 oz. . . . Set \$64.99

12-pc. STANDARD Set incl. 1/4 thru 7/8-in. sizes. Sep. prices total \$59.58, p. 18.  
9 R 49641—Shpg. wt. 3 lbs. 13 oz. . . . Set \$27.99

12-pc. METRIC Set incl. 6 thru 17mm sizes. Sep. prices total \$56.08, p. 18.  
9 R 49651—Shpg. wt. 2 lbs. 9 oz. . . . Set \$27.99

5-pc. Large-size Wrench Set for heavy machinery incl. 1 1/2 thru 1 3/4-in. sizes. Separate prices total \$67.75, p. 18.  
9 R 49681—Shpg. wt. 6 lbs. 6 oz. . . . Set \$47.99

**(12) Divided Storage Pouches**

Heavy-duty nylon Roll Pouch repels moisture and stains. Wraparound closure. Tools not included. Imported.

Small pouch holds 8 pieces. 11x13 in.  
9 R 65145—Shpg. wt. 7 oz. . . . \$7.49

Save \$2 on Large Roll Pouch when you also buy 12-pc. standard or metric wrench set (10).

Large pouch (not shown). Holds 12 pieces. 13x16 in.  
9 R 65146—Shpg. wt. 10 oz. . . . Alone \$9.49  
Pouch when you also buy 12-pc. STANDARD or METRIC wrench set (10) . . . \$7.49

**(13) Miniature Wrench Sets**

8-pc. Open-end Miniature Wrench Sets are 15° at one end, 80° at the other. Opening size identical at both ends. STANDARD Set incl. 7/32, 1/4, 1/2, 9/32, 5/16, 1/32, 3/8, 7/16-in. sizes. METRIC Set incl. 5, 5.5, 6, 7, 8, 9, 10, 11mm sizes.  
9 R 4306—STANDARD. Shpg. wt. 4 oz. . . . Set \$9.49  
9 R 4308—METRIC. Shpg. wt. 4 oz. . . . Set \$9.49

14 10-pc. Combination Miniature Wrench Sets have box-end at one end, offset open-end at other. STANDARD Set incl. 5/32x3/16 to 3/8x1/2 in. sizes. METRIC Set incl. 4x4.5 to 10x11mm sizes.  
Save \$4 when you buy these Combination Miniature Wrench Sets with 17-pc. STANDARD or METRIC Wrench Set (10).  
9 R 43441—STANDARD. Wt. 4 oz. . . . Set, alone \$10.99  
Set when you also buy 17-pc. wrench set (10) . . . \$6.99  
9 R 43443—METRIC. Wt. 4 oz. . . . Set, alone \$10.99  
Set when you also buy 17-pc. wrench set (10) . . . \$6.99

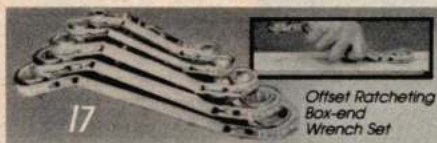
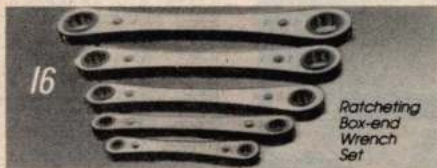

**(15) Box-end Wrench Sets**

Available at Sears in catalog only! 11-pc. STANDARD Set incl. 1/4x3/16, 3/8x7/16, 1/2x1/2, 1/2x9/16, 5/8x5/8, 3/4x3/4, 1 1/8x1 1/8, 1 1/4x1 1/4, 1 1/2x1 1/2-in. sizes. Sep. prices total \$96.69 on p. 18.  
9 R 4985—Shpg. wt. 7 lbs. . . . Set \$49.99

Available at Sears in catalog only! 11-pc. METRIC Set incl. 6x8, 7x9, 10x11, 12x14, 13x15, 16x18, 17x19, 21x23, 22x24, 25x28, 27x30mm sizes. Sep. prices total \$90.39 on p. 18.  
9 R 4986—Shpg. wt. 6 lbs. . . . Set \$49.99

7-pc. STANDARD Set incl. 1/4x3/16, 3/8x7/16, 1/2x9/16, 5/8x5/8, 1 1/8x1 1/8, 1 1/4x1 1/4, 1 1/2x1 1/2 in. sizes. Sep. prices total \$49.73 on p. 18.  
9 R 4984—Shpg. wt. 3 lbs. 1 oz. . . . \$27.99

Available at Sears in catalog only! 3-pc. Short Length Set incl. 3/8x7/16, 1/2x9/16, 5/8x3/4 in. sizes. Sep. prices total \$17.97 on p. 18.  
9 R 4366—Shpg. wt. 6 oz. . . . Set \$9.99

**16 Ratcheting Box-end Wrench Sets have Lexan polycarbonate cover. 12-pt. openings.**

5-pc. STANDARD Set incl. 1/4x3/16, 3/8x7/16, 1/2x9/16, 5/8x3/4, 1 1/8x1 1/8-in. sizes. Sep. prices total \$28.45 on page 18.  
9 R 4368—Shpg. wt. 2 lbs. 8 oz. . . . Set \$22.99

5-pc. METRIC Set incl. 6x8, 10x11, 12x13, 14x16, 17x19mm sizes. Sep. prices total \$28.45, p. 18.  
9 R 4369—Shpg. wt. 2 lbs. 8 oz. . . . Set \$22.99

17 5-pc. Offset Ratcheting Box-end Wrench Sets have thumb-operated reversing lever. Exceed Fed. Spec. GGG-W-001405 for torque capacity. STANDARD Set incl. 1/4x3/16, 3/8x7/16, 1/2x9/16, 5/8x1/2, 3/4x3/4 in. sizes. METRIC Set incl. 7x8, 9x10, 11x12, 13x14, 15x17mm sizes. Shpg. wt. 2 lbs. 6 oz.  
9 R 4364—STANDARD. . . . Set \$27.99  
9 R 43649—METRIC. . . . Set \$27.99

**\*FULL UNLIMITED WARRANTY**  
If any CRAFTSMAN® Hand Tool ever fails to give complete satisfaction, simply return it to the nearest Sears store throughout the USA and Sears will replace it, free of charge. This warranty gives you specific legal rights and you may also have other rights which vary from state to state.

•••••  
• **SearsCharge and Discover Card... each is different, but together they're all you really need**  
• To apply for SearsCharge only CALL TOLL FREE 1-800-323-3274  
• IN ILLINOIS CALL 1-800-942-7446

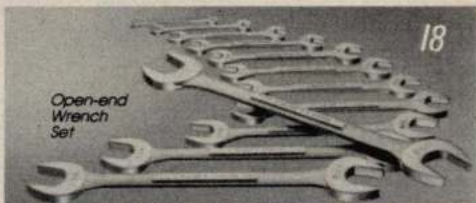

**(18) Open-end Wrench Sets**

Available at Sears in catalog only! 12-pc. STANDARD Set incl. 1/4x3/16, 3/8x7/16, 1/2x9/16, 5/8x5/8, 3/4x3/4, 1 1/8x1 1/8, 1 1/4x1 1/4, 1 1/2x1 1/2 in. sizes. Sep. prices total \$123.98 on p. 18.  
9 R 4405—Shpg. wt. 8 lbs. 1 oz. . . . Set \$64.99

Available at Sears in catalog only! 12-pc. METRIC Set incl. 10x11, 12x14, 13x15, 16x18, 17x19, 20x22, 21x23, 22x24, 24x26, 25x27, 28x30, 30x32mm. sizes. Sep. prices total \$101.68 on page 18.  
9 R 4405—Shpg. wt. 8 lbs. 1 oz. . . . Set \$64.99

Available at Sears in catalog only! 9-pc. STANDARD Set incl. 1/4x3/16, 3/8x7/16, 1/2x9/16, 5/8x5/8, 3/4x3/4, 1 1/8x1 1/8, 1 1/4x1 1/4, 1 1/2x1 1/2 in. sizes. Sep. prices total \$58.51 on page 18.  
9 R 4452—Shpg. wt. 3 lbs. 11 oz. . . . Set \$29.99

Available at Sears in catalog only! 9-pc. METRIC Set incl. 6x8, 7x9, 10x11, 12x14, 13x15, 16x18, 17x19, 20x22, 22x24mm sizes. Separate prices total \$52.81 on p. 18.  
9 R 4293—Shpg. wt. 2 lbs. 9 oz. . . . Set \$29.99

**(19) Combination Open-end/Socket-end Wrench Set**

Available at Sears in catalog only! 6-pc. Wrench Set has 12-pt. swivel socket-end for tight areas, use open-end in areas with accessible swing. Incl. 3/8, 1/2, 5/8, 3/4-in. sizes. Sep. prices total \$66.04, p. 18.  
9 R 4255—Shpg. wt. 2 lbs. 4 oz. . . . Set \$49.99

**(20) Thin-head Wrench Set**

Available at Sears in catalog only! 4-pc. STANDARD Thin-head Wrench Set for adjusting tappets incl. 3/8x7/16, 1/2x9/16, 5/8x1/2, 3/4x3/4 in. sizes. Exceeds Fed. Spec. GGG-W-636e. Separate prices total \$28.46 on page 18.  
9 R 44452—Shpg. wt. 1 lb. 1 oz. . . . Set \$19.99

**(21) Flare-nut Wrench Set**

Save \$3 on Flare-nut Wrench Set (21) when you also buy combination wrench set (19).

3-pc. STANDARD Flare-nut Wrench Set incl. 3/8x7/16, 1/2x9/16, 5/8x1/2 in. sizes. 6-pt. openings. Sep. prices total \$25.97, p. 18.  
9 R 4433—Shpg. wt. 12 oz. . . . Set, alone \$13.99  
Set when you also buy wrench set (19) . . . \$10.99

3-pc. METRIC Set incl. 9x11, 10x12, 13x14mm sizes. 6-pt. openings. Sep. prices total \$23.97, p. 18.  
9 R 4432—Shpg. wt. 8 oz. . . . Set, alone \$13.99  
Set when you also buy wrench set (19) . . . \$10.99

Do we have SOCKETS! A complete assortment of CRAFTSMAN® sockets . . .



STANDARD



METRIC

Size, in.	Pts.	Catalog Number	Wt. oz.	Each	Size, mm.	Pts.	Catalog Number	Wt. oz.	Each
Regular-depth					Regular-depth				
5/32	6	9 R 43481	1	\$1.59	4	6	9 R 43505	1	\$1.59
3/16	6	9 R 43491	1	1.59	5	6	9 R 43501	1	1.59
7/32	6	9 R 43492	1	1.59	6	6	9 R 43502	1	1.59
1/4	6	9 R 43493	1	1.59	7	6	9 R 43503	1	1.59
9/32	6	9 R 43494	1	1.59	8	6	9 R 43504	1	1.59
5/16	6	9 R 43495	1	1.59	9	6	9 R 43507	1	1.59
11/32	6	9 R 43496	1	1.59	10	6	9 R 43508	1	1.59
3/8	6	9 R 43497	1	1.59	11	6	9 R 43509	1	1.59
7/16	6	9 R 43498	1	1.59	12	6	9 R 43513	1	1.59
1/2	6	9 R 43499	1	1.59	13	6	9 R 43514	1	1.59
Deep					Deep				
3/16*	12	9 R 43608	2	1.59	4*	6	9 R 44401	3	\$2.69
7/32*	12	9 R 43609	2	1.59	5*	6	9 R 44402	3	2.69
1/4	12	9 R 43601	1	1.59	6*	6	9 R 44403	3	2.69
9/32*	12	9 R 43602	1	1.59	6*	6	9 R 44403	3	2.69
5/16	12	9 R 43603	1	1.59	7*	6	9 R 44404	3	2.69
11/32*	12	9 R 43604	2	1.59	8*	6	9 R 44405	3	2.69
3/8	12	9 R 43605	1	1.59	9*	6	9 R 44406	3	2.69
7/16	12	9 R 43606	1	1.59	10*	6	9 R 44407	3	2.69
1/2	12	9 R 43607	1	1.59	11*	6	9 R 44408	3	2.69
Deep					Deep				
3/16*	6	9 R 43571	3	\$2.09	12*	6	9 R 44409	4	2.69
7/32*	6	9 R 43572	3	2.09	13*	6	9 R 44411	5	2.69
1/4	6	9 R 43573	1	2.09	14*	6	9 R 44412	4	2.69
9/32	6	9 R 43574	3	2.09	*Available at Sears only in catalog.				
5/16	6	9 R 43575	1	2.09	Keep these pages as a personal inventory.				
11/32*	6	9 R 43576	3	2.69	Put a check mark next to the sizes you already have, and add check marks as you buy more. Tear out these pages and keep them handy in your workshop as an organized inventory sheet.				
3/8	6	9 R 43577	1	2.69					
7/16	6	9 R 43578	1	2.69					
1/2	6	9 R 43589	1	2.69					

STANDARD



METRIC

Size, in.	Pts.	Catalog Number	Wt. oz.	Each	Size, mm.	Pts.	Catalog Number	Wt. oz.	Each
Regular-depth					Regular-depth				
3/16	6	9 R 43001	1	\$2.09	9*	6	9 R 43541	3	\$2.09
7/16	6	9 R 43002	1	2.09	10*	6	9 R 43542	3	2.09
1/2	6	9 R 43003	1	2.09	11*	6	9 R 43543	3	2.09
9/16	6	9 R 43004	1	2.09	12*	6	9 R 43544	3	2.09
5/8	6	9 R 43005	2	2.09	13*	6	9 R 43545	3	2.09
11/16	6	9 R 43006	2	2.09	14*	6	9 R 43546	3	2.09
3/4	6	9 R 43007	2	2.09	15*	6	9 R 43547	3	2.09
13/16	6	9 R 43008	3	2.09	17*	6	9 R 43548	4	2.09
1/4	8	9 R 44341	1	2.69	19*	6	9 R 43549	4	2.09
5/16	8	9 R 44342	2	2.69	9	12	9 R 44301	1	2.09
3/8	8	9 R 44343	1	2.69	10	12	9 R 44302	1	2.09
7/16	8	9 R 44344	2	2.69	11	12	9 R 44309	1	2.09
1/2	8	9 R 44345	1	2.69	12	12	9 R 44303	1	2.09
3/8	12	9 R 44331	1	2.09	13	12	9 R 44304	1	2.09
7/16	12	9 R 44332	1	2.09	14	12	9 R 44305	1	2.09
1/2	12	9 R 44333	1	2.09	15	12	9 R 44306	1	2.09
9/16	12	9 R 44334	1	2.09	16	12	9 R 44311	3	2.09
5/8	12	9 R 44335	1	2.09	17	12	9 R 44307	1	2.09
11/16	12	9 R 44336	2	2.09	18	12	9 R 44312	2	2.09
3/4	12	9 R 44337	1	2.09	19	12	9 R 44308	2	2.09
13/16	12	9 R 44338	2	2.09	Deep				
Deep					9*	6	9 R 44425	4	\$3.19
3/8	6	9 R 43333	2	\$2.69	10	6	9 R 44426	2	3.19
7/16	6	9 R 43331	2	2.69	11*	6	9 R 44427	4	3.19
1/2	6	9 R 43332	2	3.19	12	6	9 R 44428	1	3.19
9/16	6	9 R 43334	2	3.19	13	6	9 R 44429	1	3.19
5/8	6	9 R 43335	3	3.19	14	6	9 R 44431	2	3.19
11/16	6	9 R 43336	3	3.19	15	6	9 R 44432	2	3.69
3/4	6	9 R 43337	3	3.69	16	6	9 R 44433	2	3.69
13/16*	6	9 R 43338	7	3.79	17	6	9 R 44434	3	4.19
7/8*	6	9 R 43339	8	3.79	18	6	9 R 44435	5	4.19
3/8	12	9 R 43301	2	2.69	19	6	9 R 44436	3	4.19
7/16	12	9 R 43311	1	2.69	9*	12	9 R 44413	4	3.19
1/2	12	9 R 43312	1	3.19	10*	12	9 R 44414	4	3.19
9/16	12	9 R 43313	2	3.19	11*	12	9 R 44415	4	3.19
5/8	12	9 R 43314	2	3.19	12*	12	9 R 44416	4	3.19
11/16	12	9 R 43316	3	3.19	13*	12	9 R 44417	6	3.19
3/4	12	9 R 43317	3	3.69	14*	12	9 R 44418	6	3.19
13/16*	12	9 R 43318	7	3.79	15*	12	9 R 44419	5	3.79
7/8*	12	9 R 43319	7	3.79	16*	12	9 R 44421	5	3.79
*Available at Sears only in catalog					17*	12	9 R 44422	5	4.29
					18*	12	9 R 44423	5	4.29
					19*	12	9 R 44424	6	4.29

Why buy a CRAFTSMAN® Socket? Because they:

- ✓ Resist breakage . . . they're constructed from a select alloy steel that's been heat-treated, oil-quenched and tempered for uniform hardness so there are no inner soft spots
- ✓ Resist nicking and provide a more comfortable feel because corners are rounded on top and bottom
- ✓ Provide extra durability, rust and corrosion resistance because they're finished with a heavy nickel-chrome plating
- ✓ Provide easy access to hard-to-reach places in 1/4, 3/8 and 1/2-inch drive sizes because they feature thin-wall construction without loss of socket strength

Our complete assortment includes:

- 4 drive sizes
- STANDARD or METRIC sizes
- Regular or deep depths
- 6, 8 and 12-point configurations

Choose the socket you need for almost any type of job



Regular depth for most mechanical, automotive and electronic work



Metric sockets with knurled band for easy identification



Impact sockets for air drive or electric impact wrenches

Deep depth sockets for work on nuts with protruding studs

Individual Impact Sockets

3/8-in. square drive impact sockets are made of alloy steel with black oxide finish. 6-point openings. Choose from STANDARD or METRIC sizes. Imported.

Size	Cat. No.	Wt. oz.	Each
19mm*	9 R 18931	3	\$2.79

Size, in.	Cat. No.	Wt. oz.	Each
STANDARD			
1/4*	9 R 18900	1	\$2.79
5/16*	9 R 18901	1	2.79
3/8*	9 R 18902	1	2.79
7/16	9 R 18903	1	2.79
1/2*	9 R 18904	1	2.79
5/8*	9 R 18905	1	2.79
3/4*	9 R 18906	2	2.79
13/16*	9 R 18907	2	2.79

# WARRANTED FOREVER!

FULL UNLIMITED WARRANTY ON CRAFTSMAN HAND TOOLS: If any CRAFTSMAN hand tool ever fails to give complete satisfaction, return it to the nearest Sears store in the United States and Sears will replace it, free of charge. This warranty gives you specific legal rights and you may also have other rights which vary from state to state.

## STANDARD

**1/2** Inch Individual Sockets

## METRIC

Size, in.	Pts.	Catalog Number	Wt. oz.	Price, each
<b>Regular-depth</b>				
7/16	6	9 R 44054	2	\$2.69
1/2	6	9 R 44055	2	2.69
9/16	6	9 R 44056	2	2.69
5/8	6	9 R 44057	2	2.69
11/16	6	9 R 44058	2	2.69
3/4	6	9 R 44059	2	3.19
13/16	6	9 R 44063	3	3.19
7/8	6	9 R 44064	3	3.19
15/16	6	9 R 44065	4	3.69
1	6	9 R 44066	5	3.69
1 1/16	6	9 R 44067	5	4.19
1 1/8	6	9 R 44068	6	4.19
1 1/4	6	9 R 44069	7	4.19
1 1/8*	8	9 R 44221	4	3.79
1 1/2*	8	9 R 44222	4	3.79
1 3/4*	8	9 R 44223	4	3.79
1 7/8*	8	9 R 44224	5	3.79
2*	8	9 R 44225	5	3.79
2 1/8*	8	9 R 44226	6	3.79
7/16	12	9 R 47501	1	2.69
1/2	12	9 R 47502	1	2.69
9/16	12	9 R 47503	1	2.69
5/8	12	9 R 47504	4	2.69
11/16	12	9 R 47505	1	2.69
3/4	12	9 R 47506	4	2.69
13/16	12	9 R 47507	2	2.69
7/8	12	9 R 47508	2	3.19
15/16	12	9 R 47509	5	3.19
1	12	9 R 47511	3	3.19
1 1/16	12	9 R 47512	3	3.19
1 1/8	12	9 R 47513	4	3.69
1 1/4	12	9 R 47514	5	3.69
1 1/2	12	9 R 47515	5	4.19
1 3/4	12	9 R 47516	6	4.19
1 7/8	12	9 R 47517	7	4.19
<b>Deep</b>				
3/4*	6	9 R 47582	4	\$4.79
7/8*	6	9 R 47583	4	4.79
1*	6	9 R 47584	3	4.79
1 1/16*	6	9 R 47585	4	5.49
1 1/8*	6	9 R 47586	5	5.49
1 1/4*	6	9 R 47587	6	5.49
1 1/2*	6	9 R 47588	6	6.49
1 3/4*	6	9 R 47589	7	6.49
1*	6	9 R 47591	8	6.49
1 1/16*	6	9 R 47592	8	6.49
1 1/8*	6	9 R 47593	10	6.49
1/2	12	9 R 47521	4	4.79
9/16	12	9 R 47522	5	4.79
5/8	12	9 R 47523	4	4.79
11/16	12	9 R 47524	5	5.49
3/4	12	9 R 47525	5	5.49
7/8	12	9 R 47526	7	5.49
15/16	12	9 R 47527	6	5.49
1	12	9 R 47528	7	6.49
1 1/16	12	9 R 47529	7	6.49
1 1/8	12	9 R 47530	8	6.49
1 1/4	12	9 R 47531	9	6.49
1 1/2	12	9 R 47532	9	6.49
1 3/4	12	9 R 47533	10	6.49

Size, mm	Pts.	Catalog Number	Wt. oz.	Price, each
<b>Regular-depth</b>				
9*	6	9 R 44251	4	\$2.69
10*	6	9 R 44252	4	2.69
11*	6	9 R 44253	4	2.69
12*	6	9 R 44254	4	2.69
13*	6	9 R 44255	4	2.69
14*	6	9 R 44256	4	3.19
15*	6	9 R 44257	4	3.19
17*	6	9 R 44258	4	3.19
19*	6	9 R 44259	5	3.69
22*	6	9 R 44260	6	4.19
9	12	9 R 44231	4	2.69
10	12	9 R 44232	1	2.69
11	12	9 R 44233	1	2.69
12	12	9 R 44234	2	2.69
13	12	9 R 44235	2	2.69
14	12	9 R 44236	1	3.19
15	12	9 R 44237	1	3.19
16	12	9 R 44238	1	3.19
17	12	9 R 44239	2	3.19
18	12	9 R 44240	2	3.69
19	12	9 R 44241	2	3.69
21	12	9 R 44242	3	3.69
22	12	9 R 44243	3	4.19
24	12	9 R 44244	4	4.19
27	12	9 R 44245	5	5.29
30	12	9 R 44246	5	5.29
32	12	9 R 44247	6	5.29
36	12	9 R 44248	11	5.29
<b>Deep</b>				
14*	12	9 R 44444	6	\$5.49
17*	12	9 R 44445	7	5.49
19*	12	9 R 44446	5	5.49
21*	12	9 R 44447	9	6.49
22*	12	9 R 44448	8	6.49
27*	12	9 R 44449	9	6.49

### Individual Impact Sockets

Alloy steel, black oxide finish. 6-point opening. Imported.

Size	Catalog Number	Wt. oz.	Price, each
<b>STANDARD</b>			
7/16-in.	9 R 18941	2	\$3.39
1/2-in.	9 R 18943	3	3.39
9/16-in.	9 R 18945	3	3.39
5/8-in.	9 R 18946	3	3.39
11/16-in.	9 R 18947	3	3.39
3/4-in.	9 R 18948	4	3.89
7/8-in.	9 R 18949	5	3.89
1-in.	9 R 18950	5	3.89
1 1/16-in.	9 R 18951	6	4.39
1-in.	9 R 18952	8	4.39
1 1/8-in.	9 R 18954	8	4.89
<b>METRIC</b>			
19mm	9 R 18933	4	\$3.49
20mm	9 R 18935	4	3.49
21mm	9 R 18937	5	3.49

STANDARD sockets have added strength for heavy-duty work. Select steel is heat-treated, oil-quenched and tempered for uniform hardness. Nickel-chrome plating resists corrosion.

**3/4** Inch Individual Sockets

### STANDARD Sockets. Regular-depth, 12-pt.

Size, in.	Cat. No.	Wt. oz.	Each	Size, in.	Cat. No.	Wt.	Each
3/8	9 R 47771	5	\$6.49	1 1/8	9 R 47783	14 oz.	\$10.99
9/16	9 R 47772	5	6.49	1 1/4	9 R 47784	1 lb.	10.99
1	9 R 47773	5	6.49	1 1/2	9 R 47785	1 lb. 2 oz.	10.99
1 1/16	9 R 47774	5	6.49	1 3/8	9 R 47786	1 lb. 3 oz.	12.99
1 1/8	9 R 47775	6	6.49	1 1/2	9 R 47787	1 lb. 6 oz.	12.99
1 1/4	9 R 47776	7	6.49	2	9 R 47788	1 lb. 11 oz.	12.99
1 1/2	9 R 47777	8	8.99	2 1/8	9 R 47789	1 lb. 14 oz.	16.99
1 3/8	9 R 47778	9	8.99	2 1/4	9 R 47791	2 lbs.	16.99
1 1/2	9 R 47779	10	8.99	2 1/2	9 R 47792	2 lbs. 2 oz.	16.99
1 7/8	9 R 47781	11	8.99	2 3/4	9 R 47793	2 lbs. 7 oz.	16.99
2	9 R 47782	11	8.99	2 7/8	9 R 47824	2 lbs. 11 oz.	16.99
				3	9 R 47825	3 lbs. 3 oz.	16.99

## CRAFTSMAN® STANDARD and METRIC Socket Sets . . .

# Save 10% to 40% over regular separate prices

Available in regular or deep depth sizes



### 1/4-inch square drive Socket Sets

10-pt. STANDARD Socket Set has 6-pt. regular-depth sockets (5/16 thru 1/2 in.). Sep. prices total \$15.90 on p. 20. Shipping weight 5 oz. 9 R 34301 . . . Set \$9.49

9-pt. deep-depth set includes 6-pt. regular-depth sockets (5/16 thru 1/2 in.). Sep. prices total \$21.21 on page 20. Wt. 9 oz. 9 R 34303 . . . Set \$18.99

28-piece Socket Set\* . . . Our Most Complete has ten 6-pt. regular-depth sockets (5/16 thru 1/2 in.); nine 6-pt. deep sockets (5/16 thru 1/2 in.); 2 slotted screwdriver bit sockets (.030, .039); 2 Phillips bit sockets (nos. 1, 2); 5 hex bit sockets (5/16 thru 3/8 in.). Sep. prices total \$75.62 on pgs. 20, 23. Shipping weight 1 lb. 7 oz. 9 R 44493 . . . Set \$49.99

10-pt. METRIC Socket Set has 6-pt. regular-depth sockets (4 thru 13mm). Sep. prices total \$15.90 on p. 20. Shipping weight 5 oz. 9 R 34302 . . . Set \$9.49

9-pt. deep-depth set\* incl. (4 thru 12mm), metal tray. Sep. prices total \$24.21 on p. 20. Wt. 14 oz. 9 R 44437 . . . Set \$19.99

28-piece Socket Set\* . . . Our Most Complete has ten 6-pt. regular-depth sockets (4 thru 13mm); nine 6-pt. deep sockets (5 thru 13mm); 2 slotted screwdriver bit sockets (.030, .039); 2 Phillips bit sockets (nos. 1, 2); 5 hex bit sockets (5/16 thru 3/8 in.). Sep. prices total \$78.62 on pgs. 20, 23. Shipping weight 1 lb. 7 oz. 9 R 44494 . . . Set \$49.99

### 3/8-inch square drive Socket Sets

8-pt. STANDARD regular-depth socket set includes 6-pt. sockets (3/8 thru 13/16 in.). Sep. prices total \$16.72 on page 20. Shpg. wt. 11 oz. 9 R 34304 . . . Set \$13.99

7-pt. deep-depth set has 6-pt. sockets (3/8 thru 1/2 in.). Sep. prices total \$21.83 on pg. 20. Wt. 1 lb. 3 oz. 9 R 34306 . . . Set \$18.99

9-pt. deep-depth set has 6-pt. sockets (3/8 thru 1/2 in.). Sep. prices total \$29.41 on pg. 20. Shpg. wt. 1 lb. 12 oz. 9 R 34308 . . . Set \$23.99

31-piece Socket Set\* . . . Our Most Complete has eight 12-pt. regular-depth sockets (3/8 thru 1 3/8 in.); nine 6-pt. deep sockets (3/8 thru 1/2 in.); two 6-pt. spark plug sockets (5/16, 3/8 in.); 3 slotted screwdriver bits (.030, .039, .055); 3 Phillips bits (nos. 2, 3, 4); 6 hex bit sockets (5/16 thru 3/8 in.). Separate prices total \$100.59 on pages 20, 23. 9 R 44495—Wt. 5 lbs. . . . Set \$72.99

8-pt. regular-depth METRIC set has 6-pt. sockets (9 thru 15, 17 mm.). Sep. prices total \$16.72 on p. 20. Shipping weight 8 oz. 9 R 34305 . . . Set \$13.99

7-pt. deep-depth METRIC set has 6-pt. sockets (11 thru 17 mm.). Sep. prices total \$24.33 on p. 20. Shipping weight 1 lb. 2 oz. 9 R 34307 . . . Set \$18.99

9-pt. deep-depth METRIC set has 6-pt. sockets (9 thru 17 mm.). Sep. prices total \$30.71 on p. 20. Shipping weight 1 lb. 7 oz. 9 R 34309 . . . Set \$23.99

31-piece Socket Set\* . . . Our Most Complete has eight 12-pt. regular-depth sockets (10 thru 15, 17, 19mm); nine 6-pt. deep sockets (10, 12 thru 19mm); two 6-pt. spark plug sockets (5/16, 3/8 in.); 3 slotted screwdriver bits (.030, .039, .055); 3 Phillips bits (nos. 2, 3, 4); 6 hex bit sockets (4 thru 8, 10mm). Sep. prices total \$103.89 on pgs. 20, 23. Shpg. wt. 4 lbs. 12 oz. 9 R 44496 . . . Set \$72.99

### 1/2-inch square drive Socket Sets

9-pt. regular-depth set has 6-pt. sockets (1/2 thru 1 in.). Sep. prices total \$27.71 on this page. Wt. 1 lb. 14 oz. 9 R 34312 . . . Set \$23.99

13-pt. regular-depth set has 6-pt. sockets (7/16 thru 1 1/4 in.). Separate prices total \$42.97 on this page. Shipping weight 1 lb. 8 oz. 9 R 34314 . . . Set \$32.99

7-pt. STANDARD deep-depth socket set has 6-pt. sockets (1/2 thru 3/4 in.). Sep. prices total \$37.33 on this page. Shipping weight 1 lb. 6 oz. 9 R 34313 . . . Set \$27.99

11-pt. deep-depth set has 6-pt. sockets (1/2 thru 1 1/8 in.). Sep. prices total \$63.29 on this page. Shipping weight 4 lbs. 9 R 34315 . . . Set \$42.99

34-pt. Socket Set\* . . . Our Most Complete includes thirteen 12-pt. regular-depth sockets (7/16 thru 1 1/4 in.); eleven 12-pt. deep sockets (1/2 thru 1 1/8 in.); six 8-pt. regular-depth sockets (7/16 thru 3/4 in.); 3 drag link sockets (9/16, 3/4, 13/16 in.); 6-pt. spark plug socket (13/16 in.). Sep. prices total \$149.66 on this page, and 23. Wt. 9 lbs. 12 oz. 9 R 44498 . . . Set \$99.99

14-pt. METRIC Socket Set\* includes thirteen 12-pt. regular-depth sockets (10, 12 thru 19, 22, 24, 27, 30mm); metal storage tray. Sep. prices total \$47.17 on this page. Shipping weight 2 lbs. 8 oz. 9 R 44497 . . . Set \$34.99

\*Available at Sears in catalog only

Have you got a tough job to do?

You can count on Sears for the special purpose tools you need...

Buy just the tools you need or **Save 17% to 48%** when you buy selected sets at right

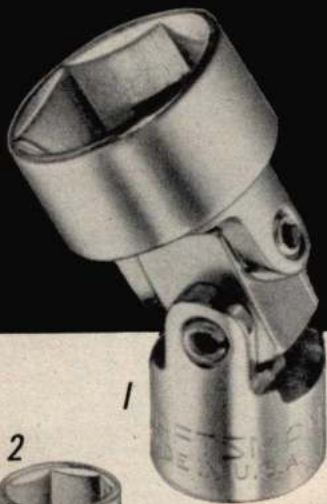

Regular spark plug sockets



Drag-link sockets 1/2-in. sq. drive

Flexible sockets 3/8-inch square drive

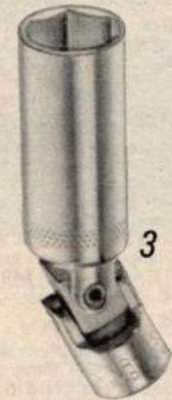

Flexible spark plug sockets

Hex setscrew bit sockets

Phillips screwdriver bit sockets

Slotted screwdriver bit sockets



Torx® bit sockets



Crowfoot wrenches (See p. 15 for extension bar)

### Individual Sockets

1 3/8-in. square drive Flexible Sockets†

#### STANDARD Flexible Sockets

Size in.	Pts.	Catalog Number	Wt. oz.	Each
3/8	6	9 R 43261	2	\$6.39
7/16	6	9 R 43262	2	6.39
1/2	6	9 R 43263	2	6.39
5/8	6	9 R 43264	2	6.39
3/4	6	9 R 43265	2	6.39
7/8	6	9 R 43266	2	6.39
1	6	9 R 43267	2	6.39
1 1/8	12	9 R 43252	4	6.39
1 1/4	12	9 R 43253	4	6.39
1 1/2	12	9 R 43254	4	6.39
1 3/4	12	9 R 43255	4	6.39
2	12	9 R 43256	4	6.39
2 1/4	12	9 R 43257	4	6.39
2 3/4	12	9 R 43258	4	6.39

#### METRIC Flexible Sockets

Size	Pts.	Catalog Number	Wt. oz.	Each
10mm	6	9 R 43201	1	\$6.39
11mm	6	9 R 43202	1	6.39
12mm	6	9 R 43203	1	6.39
13mm	6	9 R 43204	1	6.39
14mm	6	9 R 43205	2	6.39
15mm	6	9 R 43206	2	6.39
16mm	6	9 R 43207	2	6.39
17mm	6	9 R 43208	2	6.39
18mm	6	9 R 43209	2	6.39
19mm	6	9 R 43211	2	6.39

2 and 3 Spark Plug Sockets† have 6-pt. openings. Nickel-chrome plated. Sponge rubber plug holder.

#### 2 Regular Spark Plug Sockets

Sq. dr.	Size in.	Catalog Number	Wt. oz.	Price
3/8	3/8	9 R 43324	2	\$2.09
1/2	13/16	9 R 43325	4	2.09
1/2	3/4	9 R 43327	4	3.19
1/2	13/16	9 R 44241	4	3.19

#### 3 Flexible Spark Plug Sockets

Sq. dr.	Size in.	Catalog Number	Wt. oz.	Price
3/8	3/8	9 R 43322	3	\$7.29
3/8	13/16	9 R 43323	4	7.29

4 Drag-link Sockets.† 1/2-in. sq. dr. Screwdriver-type, for large size slotted bolts or studs.

Size	Cat. No.	Wt.	Price
3/8 in.	9 R 44511	4 oz.	\$5.49
1/2 in.	9 R 44512	4 oz.	5.49
13/16 in.	9 R 44513	5 oz.	6.49
13/16 in.	9 R 44514	8 oz.	6.49

### Individual Crowfoot Wrenches

9 CRAFTSMAN Crowfoot Wrenches† attach to ratchet or extension bar. Use with 3/8-in. square drive tools. See p. 15 for extension bars (12).

#### STANDARD.

Size	Cat. No.	Wt.	Each
3/8 in.	9 R 43611	3 oz.	\$4.49
1/2 in.	9 R 43621	3 oz.	4.49
1/2 in.	9 R 43622	3 oz.	4.49
3/4 in.	9 R 43623	3 oz.	4.49
3/4 in.	9 R 43624	4 oz.	4.49
13/16 in.	9 R 43625	4 oz.	5.69
13/16 in.	9 R 43626	4 oz.	5.69
13/16 in.	9 R 43627	4 oz.	5.69
3/4 in.	9 R 43628	5 oz.	5.69
1 in.	9 R 43629	6 oz.	5.69

### Individual Bits

5 Hex Setscrew Bit Sockets† STANDARD. 1/4-in. sq. dr., 1 1/8-in. long.

Size	Catalog Number	Wt.	Price
3/16-in.	9 R 42701	3 oz.	\$4.19
1/8-in.	9 R 42702	3 oz.	4.19
1/4-in.	9 R 42703	3 oz.	4.19
3/8-in.	9 R 42704	4 oz.	4.19
1/2-in.	9 R 42705	4 oz.	4.19

STANDARD 3/8-in. sq. dr., 1 1/8-in. long.

Size	Catalog Number	Wt.	Price
3/16-in.	9 R 46669	1 oz.	\$4.19
1/8-in.	9 R 46661	1 oz.	4.19
1/4-in.	9 R 46662	1 oz.	4.19
3/8-in.	9 R 46663	1 oz.	4.19
1/2-in.	9 R 46664	1 oz.	4.19
3/4-in.	9 R 46665	2 oz.	4.19

METRIC 3/8-in. sq. dr., 1 1/8-in. long.

Size	Catalog Number	Wt.	Price
*4mm	9 R 42674	1 oz.	\$4.19
*5mm	9 R 42675	1 oz.	4.19
*6mm	9 R 42676	1 oz.	4.19
*7mm	9 R 42677	1 oz.	4.19
*8mm	9 R 42678	1 oz.	4.19
*10mm	9 R 42679	2 oz.	4.19

6 Phillips Screwdriver Bit Sockets†

No.	Catalog No.	Wt.	Price
1/4-in. sq. dr., 1 1/8-in. long			
1	9 R 42681	3 oz.	\$4.49
2	9 R 42682	3 oz.	4.49
3/8-in. sq. dr., 2 1/4-in. long			
1	9 R 44369	1 oz.	\$4.19
2	9 R 44371	2 oz.	4.19
3	9 R 44372	1 oz.	4.19
4	9 R 44373	1 oz.	4.19

7 Slotted Screwdriver Bit Sockets†

Size in.	Cat. No.	Wt.	Price
1/4-in. sq. dr., 1 1/8-in. long			
0.030x 1/4	9 R 42691	3 oz.	\$4.29
0.039x 1/4	9 R 42692	3 oz.	4.29
3/8-in. sq. dr., 1 1/8-in. long			
0.030x 3/8	9 R 42651	1 oz.	\$4.19
0.039x 3/8	9 R 42652	1 oz.	4.19
0.055x 3/8	9 R 42653	2 oz.	4.19

8 Torx® Bit Sockets†

Torx® sz.	Dr.	Catalog No.	Wt.	Price
T-15	1/4 in.	9 R 42661	1 oz.	\$4.99
T-20	1/4 in.	9 R 42662	1 oz.	4.99
T-25	1/4 in.	9 R 42663	1 oz.	4.99
T-30	3/8 in.	9 R 42664	1 oz.	4.99
T-40	3/8 in.	9 R 42665	1 oz.	4.99
T-45	3/8 in.	9 R 42666	1 oz.	4.99
T-50	3/8 in.	9 R 42667	1 oz.	4.99

### Flex Socket Sets

Save 37% on STANDARD or METRIC 3/8-in. square drive FLEXIBLE Socket Sets† (not shown).

7-piece STANDARD Set includes 12-pt. sockets (3/8 thru 3/4 in.). Sep. prices total \$44.73. Wt. 15 oz. 9 R 34311... Set \$27.99

11-piece METRIC Set† includes ten 6-pt. sockets (10 thru 19mm); metal storage tray. Sep. prices total \$63.90. Wt. 1 lb. 15 oz. 9 R 44451... Set \$39.99

### Screwdriver and Hex Bit Socket Sets

6-pc. 3/8-in. Screwdriver Bit Set†† (not shown). Set includes 3 Phillips bits (nos. 2, 3, 4); 3 slotted bits (.030x 1/4, .039x 3/8, .055x 3/8-in.); vinyl storage pouch. Sep. prices total \$25.14

Save 20% when you buy set alone; save an additional \$5 when you also buy STANDARD or METRIC Flex Socket Sets 9-34311 or 9-44451 above. Shpg. wt. 9 oz.

9 R 42686—Set alone... \$19.99

Set when you also buy flex socket set... \$14.99

6-pc. 1/4-inch sq. dr. Screwdriver Bit Socket Set†† (not shown) includes 3 Phillips bit sockets (Nos. 1, 2, 3); 3 slotted bit sockets (3/16, 1/4, 5/16 inch). 9 R 46645—Wt. 2 oz.... \$3.29

Save 19% on this 7-pc., 1/4 and 3/8-in. sq. dr. Torx® Bit Socket Set†† (not shown). It includes three 1/4-in. sq. dr. bits (T-15, T-20, T-25); four 3/8-in. sq. dr. bits (T-30, T-40, T-45, T-50). Separate prices total \$34.93. 9 R 34323—Wt. 8 oz.... Set \$27.99

Save 48% on this 10-pc., 1/4-in. sq. dr. Screwdriver and Hex Bit Socket Set†† (not shown). It includes 2 Phillips bits (nos. 1, 2); two slotted bits (.030x 1/4, .039x 3/8 in.); 5 hex setscrew bits (3/16 thru 3/8 in.); vinyl storage pouch. Sep. prices total \$38.51. 9 R 42687—Wt. 9 oz.... Set \$19.99

Save 24%, 6-pc., 3/8-in. sq. dr. Hex Setscrew Bit Socket Set† (not shown). STANDARD SET includes 6 bits (3/16 thru 3/8 in.). METRIC SET includes 6 bits (4 thru 8, 10mm). Sep. prices total \$25.14 for STANDARD set and \$25.14 for METRIC set. Wt. 9 oz. 9 R 34321—STANDARD. Set \$18.99 9 R 34322—METRIC... Set \$19.99

Save 25% on this 20-pc. Bit Socket Set††... OUR MOST COMPLETE (not shown) includes sets (9-42686, 9-34321, 9-34323). Sep. prices total \$66.97. Wt. 1 lb. 10 oz. 9 R 42689... Set \$49.99

### Impact Socket Sets

Save 17%, 12-piece, 1/2-in. sq. dr. Impact Set† (not shown) includes eleven 6-pt. sockets (7/16 thru 1 1/8 in.); metal clip rail. Separate prices total \$42.29. Imported. 9 R 18938—Wt. 3 lbs. 6 oz. Set \$34.99

Save 19%, 9-piece, 3/8-in. square drive Impact Set† (not shown) includes 8 sockets (1/4 thru 1 1/8 in.); metal clip rail. Separate prices total \$22.32. Imported. 9 R 18939—Wt. 15 oz.... Set \$17.99

### Crowfoot Wrench Sets

Save 31% on this 11-pc. STANDARD Crowfoot Wrench Set†† (not shown). It includes 10 STANDARD wrenches (9) and vinyl storage pouch. Separate prices total \$50.90. 9 R 4362—Wt. 1 lb. 4 oz.... \$34.99

Save 31% on this 11-pc. METRIC Crowfoot Wrench Set†† (not shown). It includes 10 METRIC wrenches (9) and vinyl storage pouch. Separate prices total \$50.90. 9 R 4363—Wt. 15 oz.... \$34.99

†See our FULL UNLIMITED WARRANTY on page 21. \*Available at Sears in catalog only!

Don't miss our complete line of socket and bit storage units on pg. 31 of this book.

## Offset ratcheting screwdrivers give you access where conventional screwdrivers and bit drivers can't reach

**CRAFTSMAN® offset reversible ratchet screwdrivers**



**1** CRAFTSMAN offset, reversible ratchet screwdrivers.\* Alloy steel. With ¼, ⅜-in. slotted blades.\*  
9 R 4117—Wt. 1 oz. . . \$4.49  
With Nos. 1, 2 Phillips blades.  
9 R 4119—Wt. 1 oz. . . \$4.49  
With ¼-in. slotted, No. 2 Phillips blades.  
9 R 4116—Wt. 1 oz. . . \$4.49

**2** CRAFTSMAN 4-in-1 offset screwdriver.\* Chrome-vanadium alloy steel. Nos. 1, 2 Phillips, ⅜, ⅝ slotted.\*  
9 R 4112—Wt. 3 oz. . . \$5.49

**3** Available at Sears in Catalog only! Each set incl. 25° offset wrench. Thumb-operated reversing lever. Shpg. wt. 8 oz.

Bits incl.	6-pc. Set	6-pc. Set	10-pc. Set	10-pc. Set
Phillips	1, 2	1, 2	1, 2	1, 2
Slotted	⅜, ⅝	10, 15	10, 15	10, 15
Torx®		20, 25	20, 40	20, 40
		30	50	
Cat. No.	9 R 43645	9 R 43646	9 R 43647	9 R 43648
Price	\$10.99	\$13.49	\$16.99	\$17.99

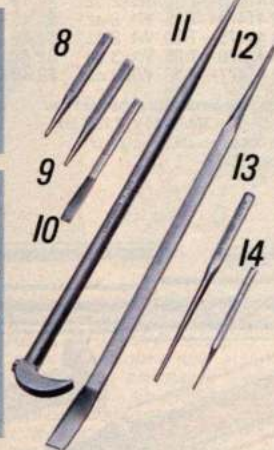

## CRAFTSMAN® steel alloy punches, chisels and line-up tools

**4 thru 14** Constructed of chrome vanadium steel, double heat-treated for durability and impact resistance. Nickel-chrome plating resists rust.\*

**4** 5-pc. punch and line-up tool set includes 4 pin punches (⅜ thru ⅝ in.); ⅝-in. line-up tool.  
9 R 4285—Wt. 10 oz. . . \$10.99

**5** 5-pc. punch and chisel set incl. 3 punches: ⅜, ⅝-in. pin, ⅝-in. center. ½, ⅝-in. cold chisels.  
9 R 4301—Wt. 1 lb. 1 oz. . . \$13.99

**6** 3-pc. chisel set incl. ¼, ⅜, ½-in. sizes.  
9 R 4309—Wt. 8 oz. . . \$8.49

**7** Available at Sears in Catalog only! 12-pc. punch, chisel and line-up set includes 4 pin punches (⅜ thru ⅝ in.); ⅝-in. center punch; ⅝-in. prick punch; 2 line-up tools (⅜x9, ⅝x7 in.); 4 cold chisels (¼ thru ⅝ in.)  
Shpg. wt. 2 lbs. 10 oz.  
9 R 43036 . . . Set \$29.99

**9-pc. punch, line-up and chisel set.** Same as (7) except no ⅝x5-in. pin punch and no ¼, ⅝-in. cold chisels.  
Shpg. wt. 1 lb. 14 oz.  
9 R 43038 . . . Set \$22.99

\*Meets Federal Specification GGG-P-313B  
\*Meets ANSI Specification B209.2  
□Meets ANSI Specification B209.1  
\*See CRAFTSMAN Warranty on p. 24.

**8** Line-up tools have hardened ends.† Not for impact use.

Size, in.	Catalog No.	Wt.	Price
⅜x7	9 R 42901	3 oz.	\$5.49
⅜x9	9 R 42902	7 oz.	6.49
¼x12	9 R 42903	11 oz.	7.49

**9** Center punch marks points for drill holes. ⅝x4½ inches.  
9 R 42861—Wt. 2 oz. . . \$3.49

**10** Prick punch pierces thin sheet metal, marks layout lines. ⅝-in. point. 4½ in. long.  
9 R 42841—Wt. 2 oz. . . \$3.49

**11** Rolling wedge bar has 90° polished rolling head. 16 in. long, ⅝-in. diam.  
9 R 42892—Wt. 1 lb. 7 oz. . . \$10.99

**12** Pry bar of chrome vanadium steel. 1½x16 in. long.  
9 R 4283—Shpg. wt. 1 lb. 1 oz. . . \$8.49

**13** Pin punches, bolts.\*

Point	Lgth.	Catalog No.	Wt.	Price
⅜ in.	4 in.	9 R 42881	2 oz.	\$3.49
⅜ in.	4 in.	9 R 42882	1 oz.	3.49
⅜ in.	4½ in.	9 R 42883	2 oz.	3.99
⅜ in.	5 in.	9 R 42884	2 oz.	3.99
⅜ in.	5 in.	9 R 42885	3 oz.	3.99
¼ in.	5½ in.	9 R 42886	4 oz.	4.49

**14** Standard-length cold chisels.□

Edge	Lgth.	Catalog No.	Wt.	Price
¼ in.	4 in.	9 R 42971	1 oz.	\$3.49
⅜ in.	5 in.	9 R 42972	2 oz.	3.99
½ in.	5½ in.	9 R 42973	4 oz.	4.49
⅝ in.	6 in.	9 R 42974	6 oz.	4.99
¾ in.	6½ in.	9 R 42975	8 oz.	5.99
⅞ in.	7½ in.	9 R 42976	1 lb.	6.49

## Adjustable wrenches



Why buy a CRAFTSMAN® adjustable wrench?

- ✓ CRAFTSMAN® hand tool FULL UNLIMITED WARRANTY provides free replacement if your wrench fails to satisfy you\*
- ✓ Precision-bronched hardened steel jaws
- ✓ Special CRAFTSMAN design that provides a torque strength that exceeds ANSI B107.8 for torque by 25%

**15** Sears adjustable wrenches. Drop-forged steel chrome-plated to resist rust. Imported (not Craftsman).

Lgth.	Cap.	Cat. No.	Shpg. wt.	Price
6-in.	⅜-in.	9 R 30874	5 oz.	\$5.49
8-in.	1-in.	9 R 30871	9 oz.	7.49
10-in.	1½-in.	9 R 30872	14 oz.	9.49
12-in.	1⅞-in.	9 R 30873	1 lb. 5 oz.	11.99

Save 19%. 2-pc. wrench set incl. 6 and 10-in. wrench sizes sold in (15) above. Sep. prices total \$14.98. Wt. 1 lb. 2 oz. 9 R 30893 . . . Set \$11.99

**16** CRAFTSMAN® adjustable wrenches of nickel-chrome plated steel. Stainless steel, spring tension knurl. Thin head for tight spots.

Lgth.	Cap.	Cat. No.	Shpg. wt.	Price
4-in.	½-in.	9 R 44601	3 oz.	\$7.49
6-in.	¾-in.	9 R 44602	4 oz.	8.99
8-in.	⅞-in.	9 R 44603	8 oz.	10.99
10-in.	1½-in.	9 R 44604	13 oz.	12.99
12-in.	1⅞-in.	9 R 44605	1 lb. 7 oz.	17.99
15-in.	1⅞-in.	9 R 44662	2 lbs. 6 oz.	27.99

Available at Sears in catalog only! Save 24%. CRAFTSMAN® 2-pc. wrench set with 8-in. and 12-in. sizes sold above. Sep. prices total \$28.98. 9 R 44651—Wt. 1 lb. 15 oz. . . \$21.99

## Hex key wrench sets

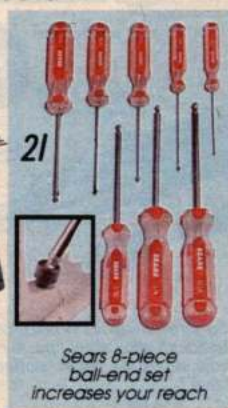
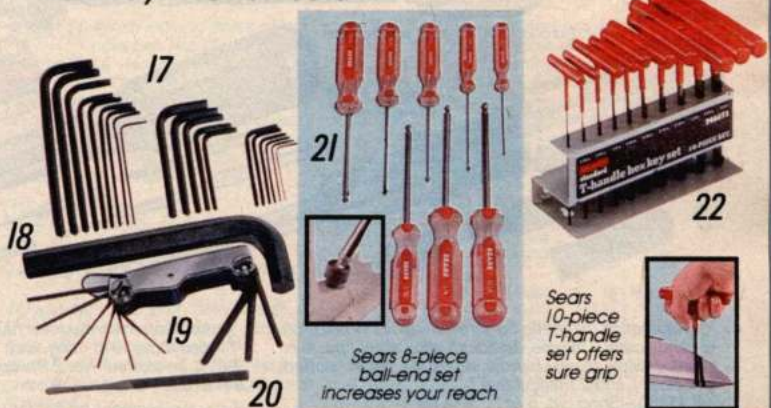

**17** CRAFTSMAN® 14 and 20-pc. sets incl. pouch. Warranted.\*

**20-pc. STANDARD set** includes .050 thru ⅝-in. short arm sizes and ⅝ thru ¾ in. long-arm sizes.  
9 R 46696—Wt. 12 oz. . . Set \$7.69

**20-pc. METRIC set** includes 1.5 thru 8mm short arm, 1.5 thru 6mm long arm sizes.  
9 R 46677—Wt. 11 oz. . . Set \$7.69

**14-pc. STANDARD set** includes .050 thru ⅝-in. short arm sizes and ⅝ thru ¾ in. long arm sizes.  
9 R 46683—Wt. 8 oz. . . Set \$4.79

**14-pc. METRIC set** includes 1.5 thru 4.5mm short arm sizes and 1.5 thru 7mm long arm sizes.  
9 R 46684—Wt. 8 oz. . . Set \$4.79

Sears 8-piece ball-end set increases your reach

Sears 10-piece T-handle set offers sure grip

**19** Sears 9-key folding hex key set. STANDARD ⅝-¼ in.  
9 R 46283—Wt. 7 oz. . . \$3.79

**20** CRAFTSMAN® ignition file. Warranted.\*  
9 R 31205—Wt. 1 oz. . . \$1.49

**21** Set lets you work on hard-to-reach set screws. 8-piece set with steel handles. Durable rust-resistant finish and chamfered ends. All sizes are marked on handles. Set includes ⅝, ⅜, ⅞, ⅝, ⅜, ⅝, ⅜, ⅝ inch sizes. Imported.  
9 R 46675—Wt. 1 lb. 8 oz. . . Set \$20.99

**22** If you often work with hex keys you'll appreciate the comfortable balanced T-handle. Great for electronics and daily maintenance work. Consists of ⅝, ⅜, ⅞, ⅝, ⅜, ⅝, ⅜, ⅝ inch sizes. Imported.  
Shpg. wt. 4 lbs. 7 oz.  
9 R 46673 . . . Set \$29.99

**18** CRAFTSMAN® METRIC drain plug wrenches. Warranted.\*  
9 R 46667—12 mm. Wt. 6 oz. . . \$4.79  
9 R 46666—17 mm. Wt. 15 oz. . . \$5.69

# CRAFTSMAN® screwdrivers and pliers are **WARRANTED FOREVER!**

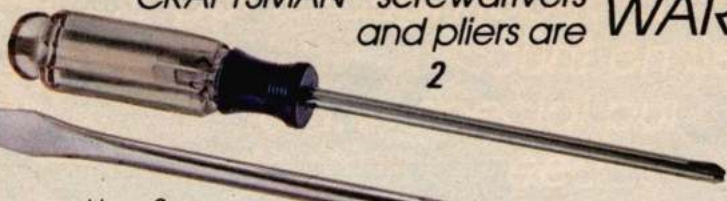

## Why buy CRAFTSMAN screwdrivers?

- Fluted plastic handles are contoured for a sure grip even in awkward positions
- 25% more turning power than conventional screwdrivers... reduces fatigue
- Chrome-plated vanadium steel blade withstands high pressure levels for years of tough, dependable service
- Grit-blasted, cross-ground blade tip holds screws better, resists slipping
- All have color-coded handles for easy identification by type

Our finest screwdrivers give dependable service even on the toughest jobs. Roughed-up tips simplify work in hard-to-reach areas.\*

### Slotted Screwdrivers

Blade in.	For screws	Catalog Number	Wt. oz.	Price, each
1/8x2 1/2	X-sm.	9 R 41596	2	\$1.99
1/8x4	X-sm.	9 R 41594	1	2.49
3/16x4	Sm.	9 R 41591	3	2.99
1/4x4	Med.	9 R 41592	4	2.99
1/4x6	Med.	9 R 41593	5	3.99
3/8x8	Lge.	9 R 41595	7	6.49

### Phillips Screwdrivers

Size	Blade in.	For screws	Catalog Number	Wt. oz.	Price, each
1	3	Small	9 R 41301	3	\$1.99
2	4	Med.	9 R 41302	4	2.99
3	6	Lge.	9 R 41303	5	3.99
4	7	Lge.	9 R 41304	2	1.99
5	8	X-lge.	9 R 41305	7	3.49
6	9	X-lge.	9 R 41306	9	5.49

Sears Best 8-pc. screwdriver set incl. all slotted (exc. 2 1/2-in.); Phillips Nos. 1, 2, 3 above. Sep. prices total \$27.92. 9 R 4159—Wt. 2 lbs. 5 oz. . . . Set \$24.99

2 Screwdrivers have grooved thumb rest for a secure grip. Shaft is square on slotted, round on Phillips. Slotted blades are fully ground on all sides for sure, accurate performance.\*

### Slotted screwdrivers

Blade in.	For screws	Catalog Number	Wt. oz.	Price, each
1/8x4	X-small	9 R 41589	1	\$1.49
3/16x4	Small	9 R 41581	2	2.49
1/4x4	Small	9 R 41582	4	3.99
1/4x1 1/2	Med.	9 R 4151	2	1.99
1/4x4	Med.	9 R 41583	4	2.99
1/4x6	Med.	9 R 41584	5	3.49
3/8x12	Med.	9 R 41585	6	6.49
3/8x1 1/2	Large	9 R 41586	4	4.49
3/8x8	Large	9 R 41587	7	5.49
3/8x12	X-large	9 R 41588	12	7.49

### Phillips screwdrivers

Size	Blade in.	For screws	Catalog Number	Wt. oz.	Price, each
0	2 1/2	X-sm.	9 R 41293	1	\$1.99
1	3	Small	9 R 41294	1	1.99
2	1 1/2	Med.	9 R 4118	2	1.99
2	4	Med.	9 R 41295	3	2.99
3	6	Med.	9 R 41296	3	3.49
3	8	Large	9 R 41297	5	3.99
4	8	X-large	9 R 41298	8	5.49

Reed Prince screwdriver for crossed-recessed screws. 1/4-in. round, 4-in. long blade.\* 9 R 4114—Shpg. wt. 3 oz. . . \$3.99

Robertson screwdriver has flared, flat head for Robertson screws found in furniture. 3 1/2-in. blade.\* Shipping weight 3 ounces. 9 R 41141—No. 1 . . . \$3.49 9 R 41142—No. 2 . . . \$3.49

Craftsman Torx® screwdriver\* has starshaped head for screws used on cars, TV's, furniture, appliances. 9 R 41473—T-10. Wt. 2 oz. . . \$2.49 9 R 41474—T-15. Wt. 2 oz. . . \$2.49 9 R 41475—T-20. Wt. 2 oz. . . \$2.49 9 R 41476—T-25. Wt. 3 oz. . . \$2.49 9 R 41477—T-30. Wt. 3 oz. . . \$2.49

Keep your hand tools organized and handy in a CRAFTSMAN® Tool Box. See our complete selection on pages 32, 33.

9-pc. screwdriver set\* includes 5 slotted: 1/8x4, 3/16x4, 1/4x6, 3/8x12 in.; 4 Phillips: 2 1/2-in. No. 0, 3-in. No. 1, 4-in. No. 2, 6-in. No. 3. Wt. 2 lbs. 4 oz. 9 R 41099 . . . Set \$22.99

18-pc. screwdriver set\* incl. 9-pc. set sold above PLUS: 1/8x2, 1/4x1 1/2, 1/4x4, 3/8x1 1/2, 3/8x8 in. Phillips: 1 1/2-in. and 8-in. No. 2; 1 Reed Prince, 1/8x4-in. slotted screwholding. Wt. 4 lbs. 9 R 41098 . . . Set \$39.99

21-pc. screwdriver set\* includes 18-pc. set sold above PLUS: 1/4x12-in. slotted, 8-in. No. 4 Phillips, and one 4-way pocket screwdriver. Wt. 4 lbs. 14 oz. 9 R 41083 . . . Set \$44.99

Pocket-clip screwdriver. 1/8x2-in. slotted blade. 4 in. long (not shown).\* 9 R 41421—Shpg. wt. 1 oz. . . \$2.49

Magnetizer/de-magnetizer for screwdrivers (not shown).\* 9 R 45021—Shpg. wt. 2 oz. . . \$1.69

### Ratcheting magnetic-tip screwdriver

Extra-long auto-return screwdriver



3 Ratcheting magnetic-tip screwdriver firmly holds bit and screw. Chrome-vanadium alloy steel tips. 4-in. shank. Hollow plastic handle stores 3/16, 1/2 in. slotted and Nos. 1 and 2 Phillips bits.\* 9 R 41466—Shpg. wt. 8 oz. . . \$13.99

Non-ratcheting magnetic-tip screwdriver (not shown) same construction as (3) above.\* 9 R 41467—Shpg. wt. 4 oz. . . \$6.49

4-bit set for (3) and 41467 above.\* 9 R 41468—Shpg. wt. 4 oz. . . \$2.99

Torx® screwdriver (not shown) similar to 41467 above has plastic handle that stores 4 vanadium alloy steel bits (T-15, T-20, T-25, T-30) 4 in. magnetic shank.\* 9 R 41401—Shpg. wt. 4 oz. . . \$9.49

Replacement bit set for 41401 above. 9 R 41402—Shpg. wt. 1 oz. . . \$4.49

### CRAFTSMAN 7-pc. nutdriver sets



8 Alloy steel sockets and shafts. Set incl. 7 sizes sold separately at right, plus case. See warranty.\*

STANDARD. Wt. 1 lb. 8 oz. 9 R 4196 . . . Set \$18.99  
METRIC. Shpg. wt. 1 lb. 10 oz. 9 R 4197 . . . Set \$18.99

### Individual CRAFTSMAN nutdrivers . . . Ea. \$3.79

Nut size	Size	Catalog Number	Wt.	Size	Catalog Number	Wt.
2-3	3/16-in.	9 R 41977	5 oz.	5 mm	9 R 41981	5 oz.
4	1/4-in.	9 R 41971	5 oz.	6 mm	9 R 41982	5 oz.
5-6	5/16-in.	9 R 41972	5 oz.	7 mm	9 R 41983	5 oz.
8	1/2-in.	9 R 41973	5 oz.	8 mm	9 R 41984	5 oz.
10	5/8-in.	9 R 41974	3 oz.	9 mm	9 R 41985	5 oz.
12 1/4	3/4-in.	9 R 41975	4 oz.	10 mm	9 R 41986	6 oz.
1 1/2	7/8-in.	9 R 41976	6 oz.	11 mm	9 R 41987	6 oz.

9 Scratch awl.\* Shpg. wt. 2 oz. 9 R 41028 . . . \$3.49

CRAFTSMAN Screw Starter\* (not shown) starts most standard slotted screws with 15 in.-lb. torque. Releases automatically. Alloy steel blade, and bit. 9 R 41024—Wt. 1 oz. . . \$2.99



**Our competition asks how we can afford our warranty?  
It's simple . . . our customer's first purchase may last a lifetime!**

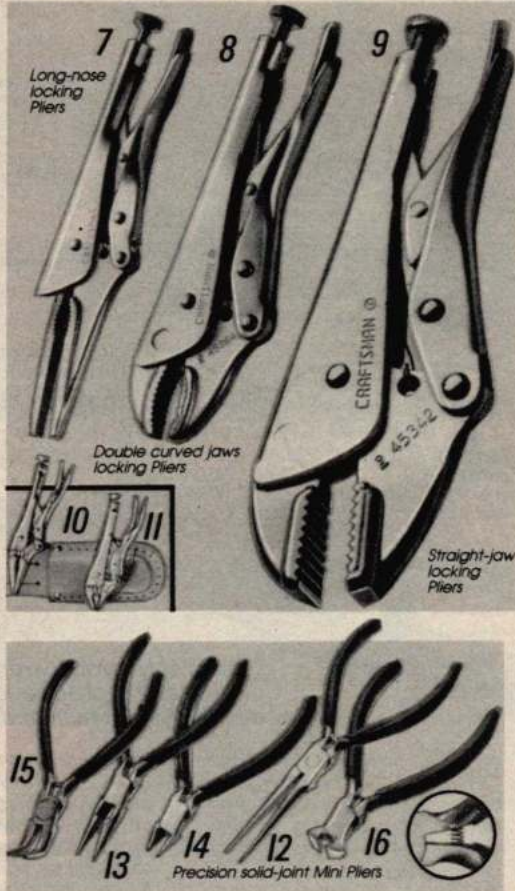
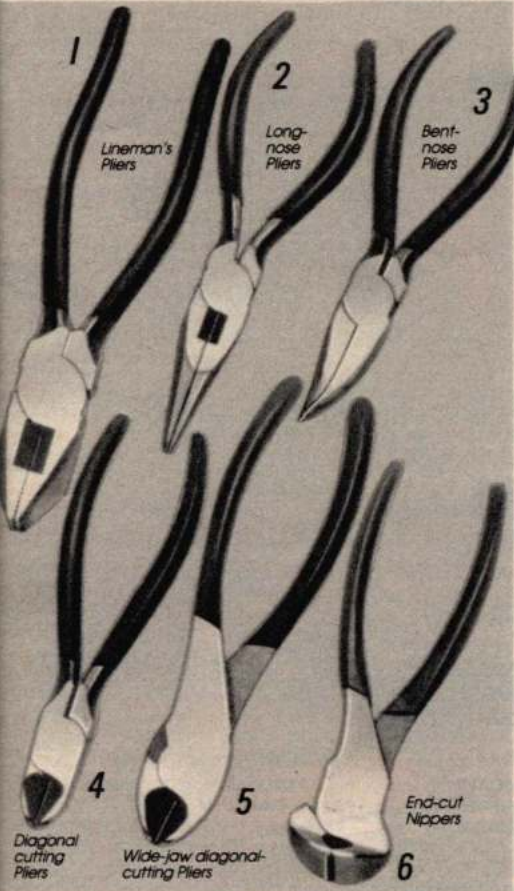

**1** Perfect for professionals working with electrical and telephone wires. Beveled nose has side-cutting jaws. 1.35-in. jaw capacity in 7-in., 1.5-in. jaw capacity on 8½-in. size.\*  
6 inch  
9 R 45091—Shpg. wt. 11 oz. . . \$11.99  
8½ inch  
9 R 45092—Shpg. wt. 1 lb. . . \$12.99

**2** Long nose pliers let you form wire loops, grip tiny pieces with tapered jaws. Side cutter.\*  
6 inch  
9 R 45081—Shpg. wt. 6 oz. . . \$9.99  
8 inch  
9 R 45082—Shpg. wt. 8 oz. . . \$10.99

**3** Bent-nose pliers for hard to reach areas. 6 inches long.\*  
9 R 45083—Shpg. wt. 6 oz. . . \$10.99

**4** Diagonal cutting pliers are ideal for working on switchboards or auto ignitions systems.\*  
6 inch  
9 R 45072—Shpg. wt. 6 oz. . . \$9.49  
7 inch  
9 R 45073—Shpg. wt. 8 oz. . . \$9.99

**5** Heavy-duty wide-jaw diagonal cutting pliers are 7 inches long for better leverage and easy steel wire cutting.\*  
9 R 45074—Shpg. wt. 9 oz. . . \$10.99

**6** End-cut nipper is tough enough to cut nails as well as wire. 6 inches long.\*  
9 R 4520—Shpg. wt. 9 oz. . . \$8.49  
\*See CRAFTSMAN Warranty on p. 24.

**7 thru 9** Use CRAFTSMAN® locking pliers as a gripping tool, pipe or locking wrench, adjustable wrench or portable vise. Cold-forged steel is nickel-plated for rust resistance. Serrated jaws give a powerful grip. Thumb screw adjusts jaw lock capacity. Squeeze handles to lock. Slight upward pressure on release bar unlocks jaws. Our largest 10-inch size provides gripping power equal to 2 tons of pressure.\*

Max. lgh. in.	Locked cap. in.	Open cap. in.	Catalog Number	Shpg. wt. lbs. oz.	Price
<b>(7) Long-nose Plier</b>					
6	1½	1¾	9 R 45349	5	\$6.49
<b>(8) Double-curved jaws for round objects</b>					
5	1¾	1½	9 R 45343	5	\$5.79
7½	1¼	1¾	9 R 45964	14	6.49
10	1¾	2¼	9 R 45961	1	4 7.49
<b>(9) With straight jaws</b>					
7½	1½	1¾	9 R 45342	15	\$6.49
10	1½	2	9 R 45341	1	4 7.49

5-pc. locking pliers set includes 7½ and 10-in. straight jaws, 5 and 7½ in. double-curved jaws, and 6 in. long nose pliers.\* Separate prices total \$32.75.  
9 R 45352—Wt. 3 lbs. 10 oz. . . \$27.99

Set of 6 locking pliers includes all pliers (7 thru 9) listed in chart above.\*  
Separate prices total \$40.24.  
9 R 45366—Shpg. wt. 5 lbs. . . \$33.99

**10 and 11** 4-inch locking pliers give a sure grip like pliers, while locking like a vise. Perfect for hard to reach areas. Ideal for home repairs. Positive grip jaws. Thumb screw adjusts jaw locking capacity. Squeeze handles to lock, slight upward pressure on release unlocks jaws.\* Includes genuine leather holster.

**(10)** Long-nose pliers  
9 R 45332—Shpg. wt. 5 oz. . . \$8.49  
**(11)** Curved jaw pliers  
9 R 45331—Shpg. wt. 5 oz. . . \$7.49

**12 thru 16** Solid joint "mini-pliers" are perfect for close delicate work. Wire springs for ease of operation. Hard-honed cutting edge gives a clean cut. Plastic handle grips. Imported.\*

Item	Size in.	Catalog Number	Wt. oz.	Price
(12) X-long-nose	5¼	9 R 4517	2	\$8.49
(13) Long-nose cutter	4¼	9 R 4518	2	8.49
(14) Diagonal	4¼	9 R 4516	2	8.49
(15) Bent-nose cutter	4¼	9 R 4519	2	8.49
(16) Plier with end cutter	4¼	9 R 4522	3	8.49

3-piece "mini-pliers" set includes (13 thru 15) listed above.\* Separate prices total \$25.47.  
9 R 45163—Shpg. wt. 7 oz. . . \$18.99

4-piece mini-pliers set includes (13 thru 16) listed above.\*  
Separate prices total \$33.96.  
9 R 45165—Shpg. wt. 11 oz. . . \$24.99

**17 and 18** Slip-joint and Arc Joint® pliers handle most tightening and loosening jobs. High-carbon Boron steel is heat treated for durability. Nickel-chrome plating resists corrosion. Precision-broached teeth give a tight grip every time. Vinyl hand grips.\*

Size in.	Positions	Jaw cap. in.	Catalog Number	Shpg. wt. lbs. oz.	Price
<b>(17) Slip-joint Pliers wire-cutting slot</b>					
6¼	2	¾	9 R 45378	7	\$5.49
8	2	1	9 R 45379	11	6.49
<b>(18) Arc Joint® Pliers</b>					
16	11	4	9 R 45384	2	15 \$22.99
13	7	2½	9 R 45386	1	11 11.99
9½	5	1½	9 R 45381	14	9.99
7	3	¾	9 R 45385	7	8.49

3-piece pliers set includes 9½-inch Arc Joint®, 8-inch long nose and 8-inch pliers with wire-cutting slot. Separate prices total \$27.47.  
9 R 45279—Wt. 2 lbs. 1 oz. . . \$19.99

**19** 5-piece nickel-plated tweezer set is ideal for tool and die work or for tiny places pliers won't reach. Includes 4-inch blunt, 4¼ inch sharp bent, 4¼ inch narrow sharp, 4½ inch sharp and 4½ inch spade points. Includes clear vinyl pouch.\*  
9 R 40362—Wt. 5 oz. . . Set \$16.99

**20** Straight tip 6-in. tweezers of alloy steel have serrations at tip for a better grip.\*  
9 R 4459—Shpg. wt. 1 oz. . . \$3.49

**21** 6½-inch long bent-tip steel tweezers are ideal for assembling delicate miniatures, tying flies, etc.\*  
9 R 4460—Shpg. wt. 1 oz. . . \$3.49

6-pc. tweezer set (not shown). Incl. 4½-in. strong sharp, 6-in. blunt serrated, 6½-in. blunt side lock, 6½-in. blunt serrated (self-closing), 6½-in. straight and 6½-in. curved.\*  
9 R 40361—Shpg. wt. 9 oz. . . \$16.99

# Look no further for our complete selection of CRAFTSMAN® snips, cutters, pliers, torque wrenches



Electricians' double-insulated tools protect you from up to 1,000 volts

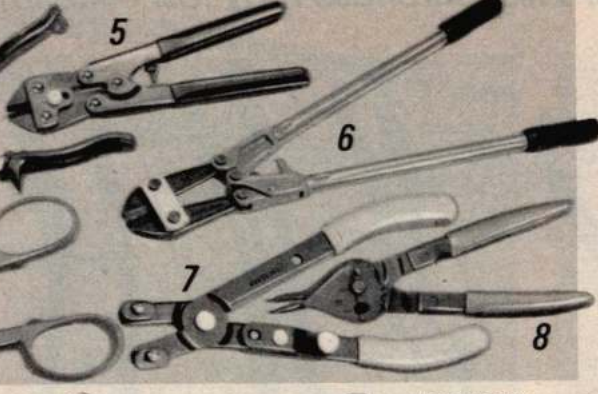
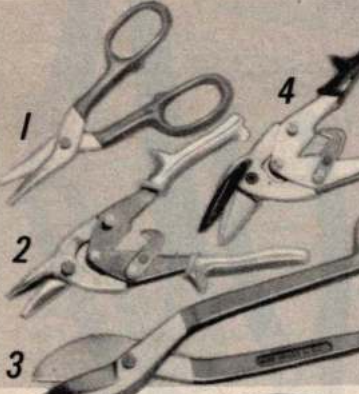

Beam-type torque wrench \$18<sup>99</sup>

MICROTORK™ torque wrench \$44<sup>99</sup>

CRAFTSMAN DIGITORK® wrench \$62<sup>99</sup>

CRAFTSMAN DIGITORK® II \$99<sup>99</sup>

CRAFTSMAN torque wrenches deliver the precise torque needed to tighten nuts and bolts

**1** CRAFTSMAN duckbill snips cut screening, sheet metal and wire. Forged steel blades, tempered cutting edges.\*

7 in. long, 1 3/4-in. max. cut.  
9 R 45463—Shpg. wt. 8 oz. . . \$8.49  
10 in. long, 2 1/2-in. max. cut.  
9 R 45461—Shpg. wt. 15 oz. . . \$9.99  
12 in. long, 3-in. max. cut.  
9 R 45462—Wt. 1 lb. 11 oz. . . \$11.99

**2** CRAFTSMAN compound leverage snips have a 12-1 power ratio. Serrated-edge blades cut maximum 1 3/8 inch. Lock arm is color coded. 10 inches long.\*

9 R 42781—Green for right cuts  
9 R 42782—Red for left cuts  
9 R 42783—Yellow for straight cuts  
Shpg. wt. each 15 oz. . . \$10.99

**3** CRAFTSMAN 16 1/2-inch heavy duty tin snips cut sheet metal, plastic. Forged steel blades have tempered cutting edges.\*

9 R 42784—Wt. 3 lbs. 10 oz. . . \$22.99  
Oval sharpening stone (not shown).  
9 R 82212—Shpg. wt. 2 oz. . . \$5.99

**4** CRAFTSMAN compound offset leverage snips have a 12-1 power ratio. Offset blades keep hands safely away from cut metal. 11 1/2 in. long. Also makes straight cuts. Color coded.\*

9 R 42795—Green for right cuts  
9 R 42796—Red for left cuts  
Shpg. wt. each 1 lb. 1 oz. . . \$13.99

**5** CRAFTSMAN 8-inch wire cutter has compound cutting action. Alloy steel jaws, cushioned grip handles. Imported.\*

9 R 4521—Shpg. wt. 12 oz. . . \$9.49  
\*See CRAFTSMAN Warranty on p. 24.

**6** CRAFTSMAN rod and bolt cutters have alloy steel jaws with compound cutting action for cutting soft to medium-hard bolts. Center-cut. Vinyl-covered hand grips. Imported.\*

24-inch length for 3/8-inch diam. bolts.  
9 R 6569—Shpg. wt. 6 lbs. . . \$32.99  
14-inch length for 1/4-inch diam. bolts.  
9 R 6567—Wt. 2 lbs. 7 oz. . . \$22.99

Replacement heads for cutters above. Imported.

For 24-inch. Shpg. wt. 2 lbs.  
9 R 65691 . . . \$13.99  
For 14-inch. Shpg. wt. 14 oz.  
9 R 65671 . . . \$11.99

**7** CRAFTSMAN internal/external snap-ring pliers are steel with plastic grips. Includes 4 pair of replacement tips: 2 pair straight, 1 pair 90°, 1 pair 45°.\*

9 R 45358—Shpg. wt. 7 oz. . . \$8.99  
4 pair of replacement tips.  
9 R 4535—Shpg. wt. 1 oz. . . Set \$1.99

**8** Tru Arc® retaining ring pliers compress or expand internal or external retaining rings. Not Craftsman.

Small size for .041 to .062 in. diam.  
9 R 45359—Shpg. wt. 3 oz. . . \$8.49  
Large size for .078 to .093 in. diam.  
9 R 45351—Shpg. wt. 6 oz. . . \$8.99

**9** Our good CRAFTSMAN® torque wrench has nylon handle that pivots for the best working angle. Measures in both directions. 1/2-in. sq. drive measures 0 to 150 ft.-lbs and 0 to 200 Newton-meters. 3/8-in. sq. drive wrench measures 0 to 50 ft.-lbs. and 0 to 70 Newton-meters.\*

1/2-in. sq. drive torque wrench.  
9 R 44642—Wt. 1 lb. 14 oz. . . \$18.99  
3/8-in. sq. drive torque wrench.  
9 R 44644—Wt. 1 lb. 5 oz. . . \$15.99

**10 thru 12** CRAFTSMAN® torque wrenches of chrome-plated, hardened steel. Reversible ratchet clicks and/or momentarily releases when preset torque is reached to prevent damage (except (12) has buzzer). Require periodic recalibration. Carrying cases sold below. Warranted by Sears. Write for free copy, see page 148.

**10** Our better CRAFTSMAN® torque wrench has a comfortable textured plastic handle. Torque is accurate to ±4% clockwise, ±6% counterclockwise. 1/2 in. sq. drive wrench measures 20 to 150 ft.-lbs. in 1 ft.-lb. increments. 3/8 in. sq. drive wrench meas. 10 to 75 ft.-lbs. in .5 ft.-lb. increments.

1/2-in. sq. drive torque wrench.  
9 R 44476—Wt. 2 lbs. 13 oz. . . \$44.99  
3/8-in. sq. drive torque wrench.  
9 R 44477—Wt. 2 lbs. 5 oz. . . \$42.99

**11** CRAFTSMAN® DIGITORK® torque wrench for 1/2 in. square drive measures 10-150 ft.-lbs. in 1 ft.-lb. increments and 10-200 Nm in 2 Nm increments. Digital readouts for English and Metric scales; accurate to ±3% in both directions. Ball bearing release mechanism delivers greater accuracy. Comfortable rubber grip handle. Stays in calibration longer than conventional torque wrenches.

9 R 44478—Wt. 2 lbs. 15 oz. . . \$62.99  
3/8-in. sq. dr. wrench. 75 ft.-lbs.  
9 R 44479—Wt. 2 lbs. 7 oz. . . \$59.99

Polyethylene carrying case (not shown). For 1/2-inch. sq. drive wrenches 9-44465, 9-44476 and 9-44478.  
9 R 44467—Shpg. wt. 15 oz. . . \$4.99

For 3/8-in. sq. drive wrenches 9-44466, 9-44477 and 9-44479.  
9 R 44468—Shpg. wt. 12 oz. . . \$4.99

Polyethylene carrying case for all torque wrenches sold on this page.  
9 R 44466—Shpg. wt. 14 oz. . . \$4.99

**12** CRAFTSMAN DIGITORK II is our most precise torque wrench. 1/2 in. sq. dr. meas. 0-200 ft.-lbs. in 1 ft.-lb. increments. 0-271.2 Nm in 1.4 Nm increments. Electronic readouts in English and Metric are accurate to ±2% in both directions. Comfortable plastic grip handle.  
9 R 44482—Wt. 3 lbs. 2 oz. . . \$99.99

**13 thru 20** End the false sense of security provided by most soft handled tools. Chrome-vanadium tools have shock-resistant inner coating and orange PVC outer coating. Insulated to 1000v. over 4°F-100°F range. Not Craftsman.

**13** 10-in. adjustable pliers.  
9 R 82219—Wt. 15 oz. . . \$22.99

**14** 6-in. diagonal cutting pliers.  
9 R 82216—Wt. 9 oz. . . \$16.99

**15** 7-inch lineman's pliers.  
9 R 82217—Wt. 12 oz. . . \$19.99

**16** 6-inch long nose pliers.  
9 R 82215—Wt. 8 oz. . . \$18.99

**17** Electricians' knife with 2 1/2-in. shrouded blade. Includes holster.  
9 R 82211—Wt. 3 oz. . . \$14.99

**18** Slotted screwdrivers are fully insulated to the tip.

Size, in.	Catalog No.	Wt.	Price
1/4x6 . . . . .	9 R 82214	3 oz.	\$5.99
1/4x4 . . . . .	9 R 82231	2 oz.	5.99
3/16x4 . . . . .	9 R 82232	2 oz.	5.49
1/8x4 . . . . .	9 R 82233	1 oz.	4.99
1/2x1 1/2 . . . . .	9 R 82234	1 oz.	4.99

**19** Phillips screwdrivers are fully insulated to the tip.

Size	Catalog No.	Wt.	Price
#2 . . . . .	9 R 82213	2 oz.	\$5.99
#0 . . . . .	9 R 82235	1 oz.	4.99
#1 . . . . .	9 R 82236	1 oz.	5.49

**20** 6-inch adjustable wrench.  
9 R 82218—Wt. 5 oz. . . \$16.99

Magnetic tip screwdriver.  
9 R 82237—Wt. 7 oz. . . \$29.99

8-in. adjustable wrench.  
9 R 82238—Wt. 12 oz. . . \$24.99

thanks  
America!

YOU HELPED MAKE CRAFTSMAN® TOOL STORAGE AND MECHANICS' TOOL SETS AMERICA'S BEST SELLERS...

We work hard to keep your vote of confidence by offering you superior American-made products at competitive prices, and that's no small accomplishment. Consider this...

If the steel we've used in our CRAFTSMAN Tools over the past 10 years was constructed into a walkway, it would span from Connecticut to California. That's approximately 2,300 MILES!



If all the steel we've used to construct our CRAFTSMAN Storage Units was used to construct a building, it would be 3 times as tall as Sears Tower. That's over 4,362 FEET HIGH!



As a special "Thank you" to our Catalog Customers, we offer this spectacular tool storage value... THE BIGGEST Storage Combination we've EVER offered!



**Just look at what you get!**

- 10-drawer professional mechanics' chest with personalized name plate and tote tray
  - 4-drawer professional mechanics' step-up chest
  - 5-drawer professional mechanics' Roll-a-way with our exclusive I-FRAME® construction that withstands 50% more stress than conventional designs.
  - Combination holds over 500-LBS. OF TOOLS in over 30.1 sq. ft. of storage space!
- PLUS includes \$100 worth of our BEST SELLING ACCESSORIES including:
- Folding side shelf
  - Chest and roll-a-way drawer dividers
  - Sliding-drawer tray
  - Roll-a-way top mat
  - 2 sets of roll-a-way drawer liners and 1 set of chest drawer liners
  - 3/8-in. drive socket organizer

ALL PROUDLY MADE IN THE USA!

**19-drawer professional Chest and Roll-a-way combination**

Save \$144 **\$399<sup>99</sup>**

Only \$15 MONTHLY, see page 148

This heavy-duty storage combination is of strong welded steel, one gauge heavier than our Homeowners' models. Reinforced side panels add strength. Chest has flexible rod to hold paperwork. Tote tray has socket compartment. All drawers lock automatically when you close the lid, top center of chest locks independently. Chest top and roll-a-way have tumbler lock and 2 keys. Includes order form for FREE personalized nameplate.

10-drawer Chest has 10.6 sq. ft. of storage. Approx. 26x12x19 in. high overall. Also sold on page 28.

4-drawer step-up Chest has 6.6 sq. ft. of storage. Approx. 26x12x12 in. high overall. Also sold on page 30.

5-drawer Roll-a-way offers 12.9 sq. ft. of storage. Approx. 26x18x34 in. high overall. Also sold on page 28.

Combination meas. approximately 62 in. high.  
See all accessories on pages 30, 31. Sep. prices total \$544.97.  
9 R 65615N—Shpg. wt. 242 lbs. ... Outfit \$399.99

Turn the page to begin our exciting 9-page section of TOOL STORAGE and STORAGE ACCESSORIES

# Choose rugged CRAFTSMAN® Tool Chests and Roll-a-ways

## HOMEOWNERS' CHESTS have external bars for locking drawers

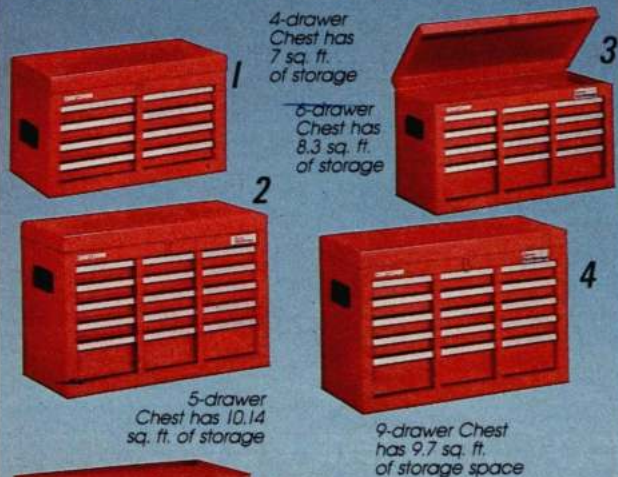

4-drawer Chest has 7 sq. ft. of storage

6-drawer Chest has 8.3 sq. ft. of storage

5-drawer Chest has 10.14 sq. ft. of storage

9-drawer Chest has 9.7 sq. ft. of storage space

## 5 HOMEOWNERS' ROLL-A-WAYS have an external security bar and hold 300 lbs.



2-drawer Roll-a-way has 5.9 sq. ft. of storage

3-drawer Roll-a-way has 10.5 sq. ft. of storage

Our 5-drawer Roll-a-way has 12.9 sq. ft. of storage

## PROFESSIONAL MECHANICS' CHESTS have automatic drawer locks

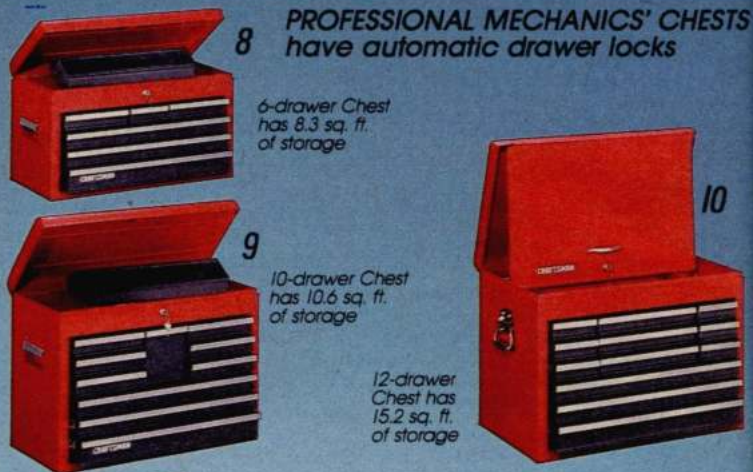

6-drawer Chest has 8.3 sq. ft. of storage

10-drawer Chest has 10.6 sq. ft. of storage

12-drawer Chest has 15.2 sq. ft. of storage

3-drawer Roll-a-way has 10.5 sq. ft. of storage

## PROFESSIONAL MECHANICS' ROLL-A-WAYS have I-FRAME® construction and hold 500 lbs.



5-drawer Roll-a-way has 12.9 sq. ft. of storage

5-drawer Roll-a-way has 15.7 sq. ft. of storage

Our 12-drawer Roll-a-way has 22.2 sq. ft. of storage space

1 thru 7 Our Homeowners' Chests and Roll-a-ways have **welded steel construction**. Full-length compound-action drawer slides. Chests have full-length staked hinge to prevent prying.

1 Drawers are 10¾ in. front to back; all 4 drawers are 18 in. wide x 1½ in. deep. Top storage is 21x10¾x1½ in. deep. Overall 22x12x13 in. high. 9 R 65808C—Shpg. wt. 26 lbs . . . **\$69.99**

2 Drawers are 11 inches front to back, 22 inches wide; four drawers, 2 in. deep; one drawer, 4 in. deep. Overall 26x13x18 in. high. 9 R 65812C—Shpg. wt. 48 lbs . . . **\$139.99**

3 Drawers are 11 inches front to back, 22 in. wide; 3 top drawers 6½x2 in. deep; 3 bottom, two 2 in. deep, one 3 in. deep. Overall 26x12x15 inches high. 9 R 65818C—Shpg. wt. 36 lbs . . . **\$129.99**

4 Drawers are 11 in. front to back; six, 6½x2 in. deep; two, 22x2 in. deep; one, 22x4 inches deep. Overall 26x12x19 in. high. 9 R 65819C—Shpg. wt. 48 lbs . . . **\$139.99**

5 Drawers are 22x13x4 in. deep each. Bottom compartment with front panel 23x13x15 in. deep. Four 3-in. diam. casters: (2 fixed, 2 swivel, one with toe brake). Overall 26x14x30 in. high. 9 R 65428N—Shpg. wt. 44 lbs . . . **\$79.99**

6 Drawers are 22x16¾ in. One drawer, 2 in. deep; two drawers 4 in. deep. Bottom compartment with front panel 17x23x11 in. deep. Four 3-in. diam. casters. 26x18x29 in. high. 9 R 65829N—Shpg. wt. 60 lbs . . . **\$139.99**

\*All dimensions are approximate  
See "N" suffix note, p. 148.  
\*See page 148.

7 \$10 MONTHLY\*. Drawers are 22x17 in. front to back. One, 2-in. deep; two 4-in. deep; two 6 in. deep. 3-in. diam. casters (2 fixed, 2 swivel, one with toe brake). Overall 26x18x31 in. high. 9 R 65834N—Shpg. wt. 75 lbs . . . **\$159.99**

8 thru 14 Professional Mechanics Chests and Roll-a-ways of **strong welded steel** are 1 gauge heavier than our Homeowners' models at left. Reinforced side covers add strength. Chest tops have **flexible rods to hold paperwork** (except 10). All drawers lock automatically when lid is closed, and top center locks independently (except 10). Tote tray, (except 10) has socket compartment. Chest tops lock with tumbler lock, incl. 2 keys. Roll-a-ways have **I-FRAME construction** that withstands 50% more stress than conventional designs. Tumbler lock, 2 keys.

8 \$10 MONTHLY\*. Drawers are 11 in. front to back: 1 top center, 5x2 in. deep; 2 top side, 8x2 in. deep; 3 bottom drawers, each 22 in. wide: two 2 in. deep; one 3 in. deep. Overall 26x12x15 inches high. 9 R 65256C—Shpg. wt. 53 lbs . . . **\$169.99**

9 \$11 MONTHLY\*. Drawers are 11 in. front to back: 1 top center, 5x6-in. deep; 6 top sides, 8x2 in. deep; 3 bottom 22-in. wide drawers, two 2 in. deep; one 3 in. deep. Overall 26x12x19 in. high. 9 R 65257C—Shpg. wt. 69 lbs . . . **\$209.99**

10 \$13 MONTHLY\*. Chest has drop-front panel cover with 3-pt. locking system. Top has 5 compartments. Drawers are 14 in. front to back: 6 top side 4x2 in. deep; 3 top center 11x2 in. deep; 3 bottom drawers 22 in. wide, two 2 in. deep, one 3 in. deep. Overall 26x16x19 in. high. 9 R 65259N—Shpg. wt. 107 lbs . . . **\$289.99**

\$11 MONTHLY\*. 12-drawer chest (not shown). 11.2 sq. ft. of storage. O.A. 26x12x19 in. high. Drawers, 11 in. front to back. 6 top side, 8x2 in. D.; 3 top center, 5x2 in. D. 3 bottom, 22 in. W.: two, 2 in. D., one, 3 in. D. 9 R 65258N—Shpg. wt. 71 lbs . . . **\$219.99**

11 \$10 MONTHLY\*. Drawers 22-in. wide, 17 in. front to back: two 3 in. deep; one 6 in. deep. Lower compartment with panel cover is 24x17x13 in. high. Overall 27x18x32 in. high. 3 in. diam. casters. 9 R 65053N—Shpg. wt. 87 lbs . . . **\$189.99**

12 \$11 MONTHLY\*. 5 drawers 22x17 in. front to back: two 3 in. deep; one 4 in. deep; two 6 in. deep. 4 in. diam. casters (2 fixed, 2 swivel with toe brake). Overall 26x18x34 in. high. 9 R 65064N—Shpg. wt. 109 lbs . . . **\$229.99**

\$11 MONTHLY\*. 6-drawer Roll-a-way (not shown) has 15.5 sq. ft. storage. O.A. 26½x18x34½ in. high. Drawers 22x17 front to back: four 3 in. deep, one 4 in. deep, one 6½ in. deep. 9 R 65066N—Shpg. wt. 104 lbs . . . **\$239.99**

13 \$11 MONTHLY\*. Drawers are 22x17 in. front to back: four 3 in. deep; one 6 in. deep. Compartment is 23x17x12 in. high. Overall 26x18x40 inches high. 5 in. diam. casters (2 fixed, 2 swivel with toe brake). 9 R 65065N—Shpg. wt. 118 lbs . . . **\$239.99**

14 \$14 MONTHLY\*. Security drawers lock independently, each is 17 in. front to back: 4 top side, 8x2 in. deep; 1 top center, 5x4 in. deep. 7 bottom, each 22 in. wide: one 2 in. deep, five 3 in. deep; one 6 in. deep. 5-in. diam. casters (2 fixed, 2 swivel with toe brake). Overall 26x18x41 in. high. 9 R 65062N—Shpg. wt. 157 lbs . . . **\$349.99**

\$13 MONTHLY\*. 9-drawer Roll-a-way has 17.8 sq. ft. of storage. Drawers are 16¾ in. front to back: four 10½x3 in. D., five 22 in. wide: two 3 in. D., two 4¾ in. D., one 6½ in. D. 26½x18x41 in. high overall. 9 R 65069N—Shpg. wt. 144 lbs . . . **\$309.99**

Sears introduces our largest, strongest, best designed CRAFTSMAN® steel chest and roll-a-way. They hold up to 2,000 lbs.† and they're **WARRANTED FOREVER!**\*

# THE LAST CHEST AND ROLL-A-WAY YOU'LL EVER HAVE TO BUY!

Weathertight drop front panel has 3-point locking system to help protect your tools

Double bitting locks on chest and roll-a-way are cut on both sides to resist picking

Extra sturdy full-length chrome-plated drawer pulls provide smooth, easy opening from front or sides

Heavy-duty slides on 2 deep bottom drawers have 50% more load capacity than upper drawers

Oil and grease resistant foam drawer liners protect your tool investment

Exclusive I-FRAME® construction is 50% stronger than conventional designs



Full-width drawers roll smoothly on ball-bearing slides

Movable divider system has predrilled holes for custom installation

Big 6x2-in. casters have grease fittings for periodic lubrication which allows smooth rolling



## CRAFTSMAN PRO SET 2000

PRO SET 2000 Chest **\$629<sup>99</sup>** \$21 MONTHLY\*\*

Provides 21.9 sq. ft. of storage. 12 drawers are 16 in. front to back; 9 drawers, 9x2 in. deep; 2 center drawers 28x2 in. deep; 1 bottom drawer 28x3 in. deep. Overall 33x18x21 inches high. • 2 keys. 9 R 65103N—Black 9 R 65105N—Red Shpg. wt. 157 lbs. . . \$629.99

\*FULL UNLIMITED WARRANTY ON PRO SET CHESTS AND ROLL-A-WAYS: If your PRO SET chest or roll-a-way fails to give you complete satisfaction, return it to the nearest Sears store in the U.S., and Sears will replace it, free of charge. This warranty gives you specific legal rights, and you may also have other rights which vary from state to state.

PRO SET 2000 Roll-a-way **\$829<sup>99</sup>** \$28 MONTHLY\*\*

2 Provides 25.1 sq. ft. of storage. 8 drawers are 28 inches wide and 16 inches front to back; 4 top drawers are 2 in. deep; 2 center drawers are 3 in. deep; 2 bottom drawers are 7 in. deep. Overall 34x18x41 in. high. • 2 keys. Heavy-duty swivel casters (see inset above), 2 with convenient toe brake. Includes full-width rubber top mat and PRO SET Commander's Cap. 9 R 65036N—Black 9 R 65038N—Red Shpg. wt. 222 lbs. . . \$829.99

3 PRO SET Commander's style cap. One size fits most heads. Black with gold-color trim. 9 R 65039—Shpg. wt. 3 oz. . . \$6.99

†2,000-lb. capacity when stationary. 1800-lb. capacity when unit is mobile. \*\*See page 148. •All dimensions approximate.

CRAFTSMAN® heavy-duty MACHINISTS' CHESTS and ROLL-A-WAYS protect your precious precision tools

Add-on chest has 3.2 sq. ft. of storage



Add-on chest has 2.3 sq. ft. of storage



7-drawer chest has 5.3 sq. ft. of storage

8-drawer chest has 6.6 sq. ft. of storage

9-drawer chest has 9 sq. ft. of storage



7-drawer roll-a-way has 18.1 sq. ft. of storage



4 and 5 Brawny steel add-on chests give extra storage. Fits under chests. 2 drawers measure 9 in. long; one 2 in. deep; one 4 in. deep. Top drawers have nylon felt inserts. Tumbler lock, 2 keys.

4 Fits under chest (6) below. 18 in. wide drawers. Overall 22x10x8 inches high. • 9 R 65321C—Shpg. wt. 20 lbs. . . \$69.99

5 Fits under chest (7) below. 24-inch wide drawers. Overall 28x10x8 inches high. • 9 R 65322C—Shpg. wt. 24 lbs. . . \$79.99

6 thru 8 Chests have front panel to cover drawers for added security. Lid support holds top in open position. Drawers have protective nylon felt inserts that can be removed for cleaning. Tumbler lock, 2 keys.

6 Drawers are 7 in. long; four 8x1 in. deep; one 8x2 in. deep; one 18x1 in. deep; one 18x2 in. deep. Overall 21x8x13 inches high. • 9 R 65227C—Shpg. wt. 33 lbs. . . \$99.99

7 \$10 MONTHLY\*\*. Drawers are 7 in. long; unlined top center 5x3 in. deep; 4 sides 8x1 in. deep; 1 side, 8x2 in. deep; 2 bottom drawers, 24 in. wide; one 1 in. deep; one 2 in. deep. Overall 28x8x13 in. high. • 9 R 65228C—Shpg. wt. 40 lbs. . . \$119.99

8 \$10 MONTHLY\*\*. Top compartment has protective felt insert. Rods in lid hold paperwork. Drawers are 11 in. long; five, 7x1 in. deep; two, 7x2 in. deep; two, 22x2 in. deep. Overall 26x12x15 in. high. • 9 R 65237C—Shpg. wt. 61 lbs. . . \$129.99

9 \$13 MONTHLY\*\*. Sturdy steel roll-a-way has I-FRAME construction for more strength than conventional designs. 7 drawers are 17x22 in. wide; four, 2 in. deep; two 4 in. deep; one 6 in. deep. Overall 29x18x36 in. H. • 2 keys. 9 R 65373N—Shpg. wt. 140 lbs. . . \$299.99

\$15 MONTHLY\*\* SAVE \$40 on Chest (8), Roll-a-way (9) combination. Separate prices total \$429.98. 9 R 65436N—Shpg. wt. 201 lbs. . . \$389.98

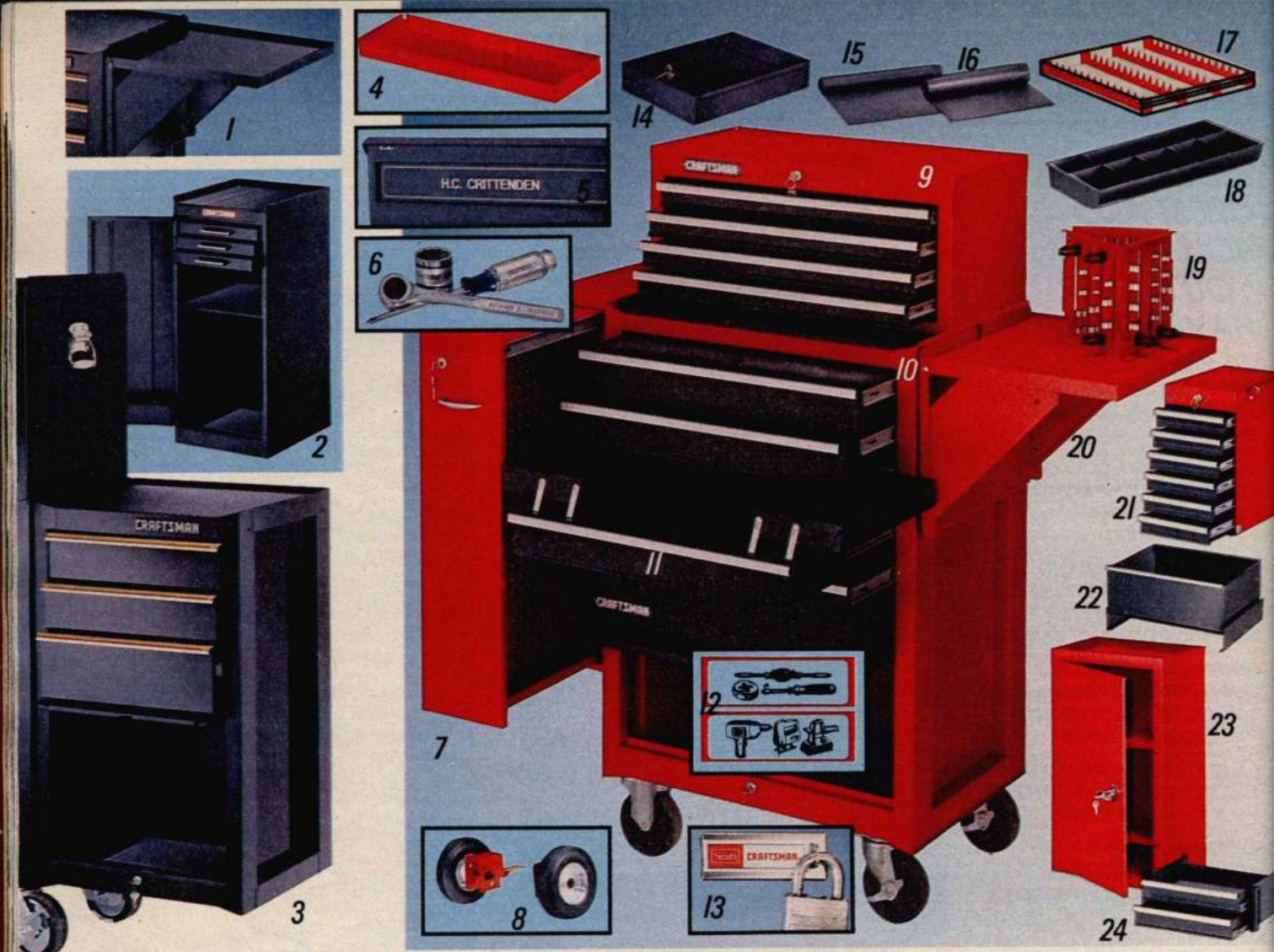

## CRAFTSMAN customizing accessories add extra storage, convenience

**1** PRO SET steel folding side shelf provides 2.2 sq. ft. of work surface. Fits all CRAFTSMAN roll-a-ways on either side or back.  $\frac{3}{8}$ -in. lip on edge. 18x18 in.  $\dagger$  Wt. 13 lbs. 4 oz. 9 R 65313C...\$34.99

**2** \$10 MONTHLY\*. PRO SET 3-drawer steel side cabinet fits either side of roll-a-way. Has interchangeable door swing. 2 large compartments have adj. shelf. Provides 6.7 sq. ft. of extra storage space. Coded lock incl. 2 keys. Drawers are 11x16x2 in. deep. Overall 14x18x32 in.  $\dagger$  9 R 65246C—Wt. 54 lbs...\$169.99

**3** \$10 MONTHLY\*. 3 drawer PRO SET steel side chest has 8.5 sq. ft. of storage. Can be mounted on either side of PRO SET cabinet only. 2 drawers 16 $\frac{3}{4}$ x15 $\frac{3}{4}$ x3 $\frac{3}{8}$  in. deep, 1 drawer 16 $\frac{3}{4}$ x15 $\frac{3}{4}$ x5 $\frac{7}{8}$  in. deep. Panel area 18x17x13 $\frac{3}{8}$  in. high. Overall 22x18x36 in. high. Compound-action drawer slides. Double-bitted, brass-plated tumbler lock, 2 keys. Protective top mat. 9 R 65247N—Wt. 78 lbs...\$199.99

**4** Steel tray 23x7x2 in.  $\dagger$  deep fits PRO SET roll-a-way drawers without dividers  $\dagger$ . Wt. 4 lbs. 4 oz. 9 R 65248...\$14.99

Steel tray (same as above) fits all roll-a-way drawers without dividers except PRO SETS, former 9-65041, top 2 drawers of 9-65323 and 9-65324. Shpg. wt. 2 lbs. 11 oz. 9 R 65121...\$9.99

$\dagger$ Dimensions are approximate  
\*See page 148

**5** Personalize your tool storage units with self-adhesive vinyl lettering. 1 $\frac{1}{2}$ -in. white script. Maximum 2 lines. State name up to 20 letters per line. Allow 13 days for delivery. No C.O.D.s  $\dagger$  9 R 65129V—Wt. 2 oz...\$9.99

**6** Personalize your tools with this set of 28 aluminum nameplates in 4 different sizes: eight  $\frac{3}{16}$ x2 $\frac{1}{2}$  in. for ratchets and flat wrenches; eight  $\frac{1}{8}$ x2 $\frac{1}{2}$  in. for sockets; eight  $\frac{3}{16}$ x1 $\frac{1}{4}$  in. for screwdrivers; four  $\frac{1}{2}$ x3 $\frac{1}{2}$  in. for miscellaneous use. Allow 16 days for delivery. No C.O.D.s. Print name to maximum 14 letters. F 9 R 49999V—Wt. 1 oz...Set \$4.99

**7** Store long tools vertically in this heavy-gauge steel side box. Slide-out perforated drawer accepts pegboard hooks (not incl.). Mount on either side of roll-a-way with hardware included. Some drilling required. 7x17x28 in. high overall.  $\dagger$  9 R 65359C—Wt. 24 lbs...\$74.99

**8** Outrigger wheels give your CRAFTSMAN roll-a-way extra stability, easy mobility. Incl. two 10-in. diam. rubber wheels, 2 brackets, two  $\frac{1}{2}$ -in. diam. axles. Mount using existing holes, hardware. Replaces 3, 4, 5-in. wheels. 9 R 65123C—Wt. 27 lbs...Set \$79.99

**9** Steel 4-drawer add-on chest has 6.8 sq. ft. of storage space. Drawers are 11x22x2 in. deep. 26x12x12 in. high overall. Fits above all roll-a-ways and under all chests except 9-65208, 9-65219, 9-65259, 9-65269 and PRO SETS. 9 R 65225C—Wt. 39 lbs...\$94.99

**10** Large sliding steel work surface fits over open drawer. Rubber mat top. 23x16 in. long.  $\dagger$  Fits drawers on all roll-a-ways except former 9-65041 and PRO SETS. Shpg. wt. 5 lbs. 14 oz. 9 R 65122...\$18.99

**11** Steel cantilever tray. 2 trays, each with 4 compartments. 12x7x2 in. deep. Fits all 3-in. or deeper drawers  $\dagger$ . Shpg. wt. 7 lbs. 3 oz. 9 R 65126...\$29.99

**12** Adhesive pictorial labels. Incl. twenty 3x1-in. labels. Shpg. wt. 1 oz. 9 R 65127...Set \$2.49

**13** Mount this lock guard over your tumbler lock for extra security. Includes 4 bolts. Shpg. wt. 3 oz. 9 R 65118...\$5.79

**14** Steel security drawer locks separately from roll-a-way and may be bolted into drawer (bolts not included). 16x11x3 inches deep.  $\dagger$  Fits all 3-inch or deeper drawers without dividers. Shpg. wt. 6 lbs. 6 oz. 9 R 65124...\$29.99

**15** Roll-a-way rubber cabinet top mat helps protect against scratches. 18x26 inches  $\dagger$  9 R 65221—Wt. 1 lb. 3 oz...\$9.49

**16** Polyethylene foam drawer liner  $\dagger$ .

Fits	Pcs.	Drawer size inches	Catalog Number	Wt.		Price
				lbs.	oz.	
Chest	6	22x11	9 R 65215	2	5	\$8.49
Cabinet	5	22x17	9 R 65216C	2	5	9.49

**17** Polypropylene tool dividers/holders in pkgs. of 4. Won't rust or corrode.

For roll-a-ways: holds 14 tools. 17x2 inches H.  $\dagger$  9 R 65298—Wt. 1 lb...Pkg. \$2.99  
For chests: holds 10 tools. 11x2 in. H.  $\dagger$  9 R 65299—Wt. 10 oz...Pkg. \$2.49

**18** Polystyrene parts tray has 8 compartments. Fits most chest, roll-a-way drawers. 7x2x13 in. long.  $\dagger$  9 R 65211—Wt. 10 oz...\$3.49

**19** Steel socket tray set can be clipped together for carrying. Holds ten  $\frac{1}{4}$ , fourteen  $\frac{3}{8}$ , and sixteen  $\frac{1}{2}$ -in. sizes. Includes 6 driver clips. 9 R 41354—Wt. 4 lbs. 3 oz...\$23.99

**20** Steel folding side shelf holds up to 70 lbs. Includes braces. 18x15x14 in. extended.  $\frac{3}{8}$ -in. lip on edge.  $\dagger$  9 R 65213—Wt. 10 lbs. 1 oz...\$27.99

**21** 6-drawer tool caddy attaches to either side of roll-a-way. Tumbler lock, 2 keys. Drawers, 11x8x2 inches. 12x9x15 in. H. overall.  $\dagger$  9 R 65205C—Wt. 27 lbs...\$79.99

**22** Steel 9-in. deep drawer fits roll-a-ways with lower storage compartments. 23x16x9 in. deep.  $\dagger$  9 R 65125C—Wt. 14 lbs. 15 oz...\$39.99

**23** Heavy-gauge steel hang-on cabinet mounts to roll-a-way. T-handle with tumbler lock, 2 keys. 2 sturdy steel shelves adjust at 3-inch intervals. Accepts up to 4 sets of drawers (24) below. 18x11x29 inches  $\dagger$  9 R 65245C—Wt. 31 lbs...\$99.99

**24** Steel 2-drawer set for (23) above. Drawers, 13x9x3 in. deep. 17x10x6 in. H. overall.  $\dagger$  9 R 65207—Wt. 8 lbs. 2 oz...Set \$34.99



2-shelf Service Cart

Industrial Maintenance Cart has dual utility doors

6-drawer Cart carries up to 1,000 lbs.

A workshop on wheels! Tool Cart has storage on both sides, PLUS floor jack!

## Mobile Carts give special storage space and support to heavy, oversized tools... all accept CRAFTSMAN accessories

**1** CRAFTSMAN 2-shelf steel service cart has 5.1 sq. ft. of storage. Reversible top tier can be used as a tray or flat top. Shelf surfaces are 32x16x3 in. deep. Overall 23x17x30 inches high\*. Wt. 37 lbs. 9 R 65357C... **\$89.99**

**2** \$12 MONTHLY (see p. 148). CRAFTSMAN industrial maintenance cart has 13.7 sq. ft. of storage, and 3.3 sq. ft. of surface on its 26x18-in. wide top. Heavy gauge steel. One door has pegboard surface for hanging tools with hooks (not incl.), other door has 3 shelves. Both doors have handles. Drawers, doors lock with tumbler lock, 2 keys incl. Overall 26x18x43 in. high. 3 drawers are 22x17x2 in. deep each. 10-in. deep top compartment, 11-in. deep bottom compartment\*. 9 R 65347N—Wt. 104 lbs. **\$279.99**

**3** \$14 MONTHLY (see p. 148). Heavy-gauge steel 6-drawer cart carries loads up to 1000-lbs. Holds any CRAFTSMAN mechanics' roll-a-way except former 9-65041 and PRO SETS. Two 10-in. diam. wheels with rubber tires, two 5-in. swivel casters with toe brakes. Platform is 20x29 in. wide. Platform to top is 29 in. high. Overall 43x20x35 in. high. Drawers are 17x13 in. long. One, 2 in. deep; four, 4 in. deep; one 5 in. deep\*. Tumbler lock incl. 2 keys. 9 R 65206N—Wt. 143 lbs. **\$339.99**

**4** \$40 MONTHLY (see p. 148). A workshop on wheels! This CRAFTSMAN Tool Cart provides a big 31.1 sq. ft. of storage and 7.5 sq. ft. of work surface on its 45x24 in. wide industrial grade hardboard top. Heavy-gauge steel unit has doors and drawers with keyed-alike tumbler lock, 2 keys. Foot-operated floor jack mounted on swivel-caster end of cart helps stabilize unit when needed. Overall 45x24x36 in. high. 7 drawers on the left are 26x17 in. front to back: four 2 in. deep, two 4 in. deep, one 6 in. deep. Vertical compartment with locking door has 3 shelf surfaces, 15x17 in. front to back: one 7 in. high, one 8 in. high, one 9 in. high. Three horizontal compartments on the right side have 2 drop doors with chain supports. Closes with magnetic catches; 3-point locking system. Front to back, compartments measure: 40x5x5 in., 40x6x5 in., 40x11x5 in.\* See note. F 9 R 65212N—Wt. 360 lbs. **\$1199.99**

\*Dimensions are approximate  
NOTE: Items with "F" prefix sent from factory. Unavailable. Contact Sears selling unit for shipping and handling charges. Allow extra time. No C.O.D. orders.



Convenient Socket Storage

Handy Magnetic Socket Holder

**5 and 6** Permanex® plastic utility boxes store sq. dr. sockets. Double wall construction of high density polyethylene.

(5) For 3/8 in. 11x5x1 1/2 in. deep. 9 R 65294—Wt. 11 oz... **\$2.79**

For 1/2 in. 12x5x2 1/4 in. deep. 9 R 65295—Wt. 7 oz... **\$2.95**

(6) For 1/4 in. 8 1/2x4 1/2x2 in. deep. 9 R 65293—Wt. 8 oz... **\$1.79**

**7** Steel socket carry racks have vinyl covered handle. 1/4-in. drive rack holds 16 sockets. 3/8 and 1/2-in. drive racks hold 14 sockets (not incl.). STANDARD racks are chrome-plated. METRIC racks are brass-colored.

For sq. dr. size	STANDARD Cat. No.	Wt. oz.	METRIC Cat. No.	Wt. oz.	Price
1/4-in.	9 R 41333	4	9 R 41343	4	\$2.39
3/8-in.	9 R 41334	3	9 R 41344	4	2.39
1/2-in.	9 R 41335	4	9 R 41345	5	2.39

Replacement Clips for STD. racks. 9 R 41336—For 1/4-in. sq. drive. 9 R 41337—For 3/8-in. sq. drive. 9 R 41338—For 1/2-in. sq. drive. Wt. 1 oz... Pkg. of 10 **\$1.29**

**8** Available only in Catalog! Metal socket trays. For 1/4-in. sq. drive. 9 R 33482—Wt. 3 oz... **\$2.49**

3/8-in. sq. drive. 8 regular sockets. 9 R 33484—Wt. 3 oz... **\$2.49**

3/8-in. sq. drive. 9 deep sockets. 9 R 33485—Wt. 6 oz... **\$2.69**

**9** Steel socket tray set can be clipped together for easy carrying. Holds ten 1/4, fourteen 3/8, and sixteen 1/2-in. sizes. Includes 6 driver clips. Wt. 4 lbs. 3 oz. 9 R 41354... **\$23.99**

Steel socket trays (not shown) mount on wall or stand up. Overall 7x8x1 in. high. 2 clips for drivers. Holds 14 sockets (not incl.). Wt. 1 lb. 8 oz. 9 R 41351—For 1/4 in. drive **\$9.49** 9 R 41352—For 3/8 in. drive **\$9.49** 9 R 41353—For 1/2 in. drive **\$9.49**

**10** This handy Magnetic Socket Rack holds sockets, tools. 9 R 41311—Wt. 11 oz... **\$5.99**



**11 and 12** Heavy-duty caster sets support up to 400 lbs. Fit CRAFTSMAN tool stands, leg sets and cabinets, except models 9-19821, 31, 41, 61, and 51.

**11** Four swivel casters have foot operated lever for adjusting. 9 R 22222—Wt. set 10 lbs. **\$54.99** Any 2 or more... Each set **\$46.74**

**12** Two front swivel casters with foot operated lever for raising or lowering, 2 non-swivel rear casters. 9 R 22221—Wt. set 6 lbs. **\$44.99** Any 2 or more... Each set **\$38.24**

**13** Set of two appliance rollers support up to 2000 lbs. 3-in. wide aluminum frame with neoprene pads. Adjust from 1 1/2 to 2 1/2 in. long. Wing nut depth adjustment. 16 styrene wheels per frame. Shpg. wt. pair 1 lb. 15 oz. 9 R 74202... Pair **\$9.49** Any 2 or more pair, each pair **\$8.06**

**14** 6-inch Super Dolly has 200 lb. load rating. Three 1 1/4 inch polyolefin wheels swivel on self-lubricating bearings. Neoprene foam corner pads, recessed center hole holds objects firmly. Steel, triangular shaped dolly. 9 R 74138—Wt. ea. 1 lb. Each **\$5.99** Any 2 or more... Each **\$5.09**

**15 thru 17** These heavy-duty casters all have flat top-plate and zinc-plated finish, self-lubricating ball bearings; semi-steel and iron wheels have plain ball bearing. Maximum load capacities per caster double when motionless.

**Save 15%** when you buy any 2 or more Mobility Items (11 thru 17)

**15** 3-inch diam. wheel, 3 1/16-in. caster. Ht. 2 5/8-in. swivel radius. 1 in. wide tread. 210-lb. load cap. Rigid caster. Wt. ea. 1 lb. 8 oz. 9 R 74471... Each **\$5.99** Any 2 or more... Ea. **\$5.09**

Swivel caster. Wt. ea. 1 lb. 13 oz. 9 R 74474... Each **\$6.49** Any 2 or more... Ea. **\$5.51**

4-in. diam. wheel, 5-in. caster. Ht. 3 1/8-in. swivel radius. 1 5/8-in. tread. 300-lb. load cap. Rigid caster. Wt. ea. 2 lbs. 12 oz. 9 R 74477... Each **\$9.99** Any 2 or more... Ea. **\$8.49**

Swivel caster. Wt. ea. 3 lbs. 9 oz. 9 R 74481... Each **\$10.99** Any 2 or more... Ea. **\$9.34**

Swivel caster. Wt. ea. 4 lbs. 7 oz. 9 R 74482... Each **\$10.99** Any 2 or more... Ea. **\$9.34**

# Americans buy more CRAFTSMAN® Tool Boxes



1 Flat top Tool Box with Tote Tray provides 931 cu. in. of storage **\$798**



2 Welded steel Tool Box with plastic tray has 1296 cu. in. of storage **\$1999**



3 Mechanic's Tool Box with Tool Shuttle has 1296 cu. in. of storage **\$2799**



4 Our Finest Flat-top Tool Box has sectioned Tote Tray and 1610 cu. in. of storage **\$2799**



## Why is this Tool Box Sears Best?

- ✓ Cap end construction for increased durability
- ✓ Rolled edges add strength and eliminate sharp edges
- ✓ Internal corner supports add rigidity and tote tray placement
- ✓ Full-length staked piano hinge with water shed design adds security
- ✓ Heavy-duty chrome-plated hardware resists rust, adds security
- ✓ Dependable steel handle is plastisol coated for comfortable easy carrying
- ✓ Steel tote with comfort handle has compartments for organization
- ✓ Hasp is staple-welded inside for security
- ✓ 1610 cu. in. of storage space

**\$3299**



6 Our Extra-large Flat-top Tool Box has a Tote Tray and big 2180 cu. in. of storage **\$4999**

## Cantilever Tool Boxes

For small tools and parts

7



1 Box has plastic tote tray that measures 18 $\frac{3}{4}$ x5x1 $\frac{1}{8}$  in. deep. Overall tool box measures 19x7x7 in. high. Not Craftsman. 9 R 65078—Shpg. wt. 5 lbs. 2 oz. . . \$7.98

2 Holds tools up to 17 in. long. Plastic tray measures 16 $\frac{7}{8}$ x5 $\frac{1}{4}$ x1 $\frac{1}{8}$  in. deep. Overall box measures 18x8x9 in. high. 9 R 6501—Shpg. wt. 8 lbs. 8 oz. . . \$19.99

Same as (2) except has 893 cu. in. of storage. Plastic tote tray is 15x5x2 in. deep. Tool box measures 16x7x8 in. high. 9 R 65014—Shpg. wt. 5 lbs. . . \$12.99

3 Box includes plastic tool shuttle with pencil sharpener in special handle, lift-out parts bin and tray with 10 socket holders. Tray measures 17x6x3 inches deep. Overall box measures 18x8x9 inches high. 9 R 65008—Shpg. wt. 7 lbs. 12 oz. . . \$27.99

Tool shuttle alone. Shown with (3) above. 9 R 65007—Shpg. wt. 2 lbs. 12 oz. . . \$9.99

4 Tool Box measures 20x9x10 inches high. Partitioned tray measures 19x8x2-inches deep. Shpg. wt. 12 lbs. 8 oz. 9 R 6512 . . . \$27.99

Same as (4) above except 18x8x9 in. high. Tray measures 17x7x2 in. deep. 9 R 6500—Shpg. wt. 10 lbs. 6 oz. . . \$23.99

Provides 2142 cu. in. of storage with 6 trays

Double-cover Box provides 2215 cu. in. of storage with 4 trays

8



5 Sears Best tool box has contemporary styling. Incl. coupon for free personalized name plate. Tote tray 19x8x2 inches deep. Overall 20x9x10 inches high. Shpg. wt. 12 lbs. 8 oz. 9 R 6513 . . . \$32.99

6 Store larger sized tools in this box with 23x9x2 inches deep tote tray. Overall measures 24x10x10 inches high. 9 R 65141C—Shpg. wt. 20 lbs. . . \$49.99

7 Available only in Catalog. 6 trays with movable dividers fold out when plastic box is opened. Each tray is 16x4x1 inches deep. Overall 19x10x11 inches high. 9 R 65361—Shpg. wt. 9 lbs. . . \$39.99

8 Double cover box holds tools up to 17 in. long. 4 trays with 10 movable dividers fold out when box is open. Each tray 16 $\frac{1}{2}$ x4 $\frac{1}{2}$ x1 $\frac{1}{2}$  in. deep. Hip roof design with polyethylene top handle. Two drawbolt latches and padlock eye. 9 R 6536C—Shpg. wt. 24 lbs. . . \$57.99

9 Box with reinforced corners has knockout plug for carrying your square, a clip for 2 handsaws. Tote tray meas 29x7x2 inches deep. Overall box measures 30x9x10 inches high. Shpg. wt. 18 lbs. 9 R 6516C . . . \$39.99

9 Carpenter's Tool Box with Tote Tray provides 2410 cu. in. of storage



# and chests than any other brand sold in this country!

That's a vote of confidence we've worked hard to earn and work hard to keep

2-drawer  
tool chest  
has 1145 cu. in.  
of storage  
**\$37<sup>99</sup>**

10



Rugged  
3-drawer  
tool chest  
has 1403 cu. in.  
of storage  
**\$54<sup>99</sup>**

12



2-drawer tool  
chest has a  
cantilever tray  
and 1145 cu. in.  
of storage  
**\$57<sup>99</sup>**

13



CRAFTSMAN

CRAFTSMAN

11

3-drawer tool chest  
has 1200 cu. in. of storage  
**\$44<sup>99</sup>**



14



1/4 in. drive socket  
storage box has 399 cu. in.  
of storage

Lightweight tool box has  
585 cu. in. of storage

16



10 Chest drawers are 18x7x2 in.  
deep. Overall 20x8x9 in. high.  
9 R 65333C—Wt. 16 lbs. . . \$37.99

11 Chest drawers are 16x7x2 in.  
deep. Overall 18x8x12 in. high.  
9 R 65330C—Wt. 19 lbs. . . \$44.99

12 Chest drawers, 18x8x2 in. deep.  
Overall 20x8x12 in. H.  
Shpg. wt. 23 lbs.  
9 R 65337C—Red . . . \$54.99  
9 R 65338C—Hi-tech gray . . . \$59.99

13 Top compartment is 3 in. deep.  
Cantilever tray, 1 in. deep. 2  
drawers 17x8x2 in. deep each.  
Overall 20x8x9 in. high.  
9 R 6532C—Wt. 19 lbs. . . \$57.99

14 Store your 3/4-in. drive sockets in  
this specialty box that also holds  
tools up to 20 in. long.  
Measures 21x6x3 in. deep.  
Shpg. wt. 6 lbs. 8 oz.  
9 R 6506 . . . \$19.99

\*See page 148  
Note: All dimensions are approximate

15 Box has partitioned tote tray  
with full-length handle. Tray  
measures 19x7x2 inches deep.  
Overall 20x7x8 inches high.  
Shpg. wt. 8 lbs. 14 oz.  
9 R 65164 . . . \$18.99

16 Polyethylene tool box won't  
rust, resists marring. Tote tray is  
14x5x2 in. deep. Overall 17x8x7  
inches high.  
9 R 65096—Shpg. wt. 3 lbs. . . \$11.99

17 Carry necessary tools to the job,  
then use it to stand or sit on.  
Stores measuring tape, power drill,  
hammer, and many awkwardly  
shaped tools. Strong polyethylene  
construction. Not Craftsman.  
Shpg. wt. 4 lbs. 2 oz.  
9 R 6509 . . . \$9.99

18 Lightweight, rugged  
polypropylene tote has 4  
sections in top. Partitioned 1 1/2 in.  
deep drawer holds even deep well  
sockets. Overall 15x9 1/2x6 7/8 in. high.  
Not Craftsman.  
9 R 65006—Wt. 1 lb. 8 oz. . . \$5.99



15

Tote caddy holds  
350 lbs.

17



Hip roof  
tool box  
has 1015  
cu. in. of  
storage

18

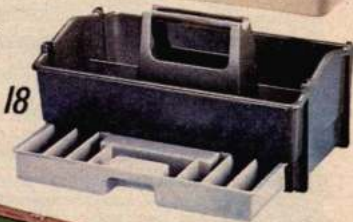

Sears tool tote has  
an 8 compartment  
drawer, socket  
divider and 475  
cu. in. of storage

19 \$12 MONTHLY\*. Over 70 pieces of wood are hand selected and hand fitted  
for each Gerstner® machinists' tool chest. 3-in. deep top compartment;  
lockable front panel stores beneath bottom drawer. Durable chrome-plated  
hardware. All drawers are lined with wool felt to protect your precision tools.  
Drawers are 8 3/4 in. front to back: Handbook drawer 2 7/8 in. x 5 in. deep; 4 drawers  
9 7/8 in., two 1 1/4 in. deep, two 3/4 in. deep; 3 drawers 24 1/4 in., one 3/4 in. deep, one  
1 in. deep, one 2 1/4 in. deep. Overall 26 in. (L) x 16 1/4 in. (H) x 10 1/2 in. (W). Allow 22  
days for delivery. No C.O.D. orders.  
F 9 R 65112—Shpg. wt. 44 lbs. . . \$249.99

Gerstner®  
8 drawer  
handcrafted  
hardwood  
tool chest  
**\$249<sup>99</sup>**

19



**A Sears Exclusive!**

**Now you can create a workplace suitable to your specific needs with the CRAFTSMAN® SELECT-A-TOP Workbench System**

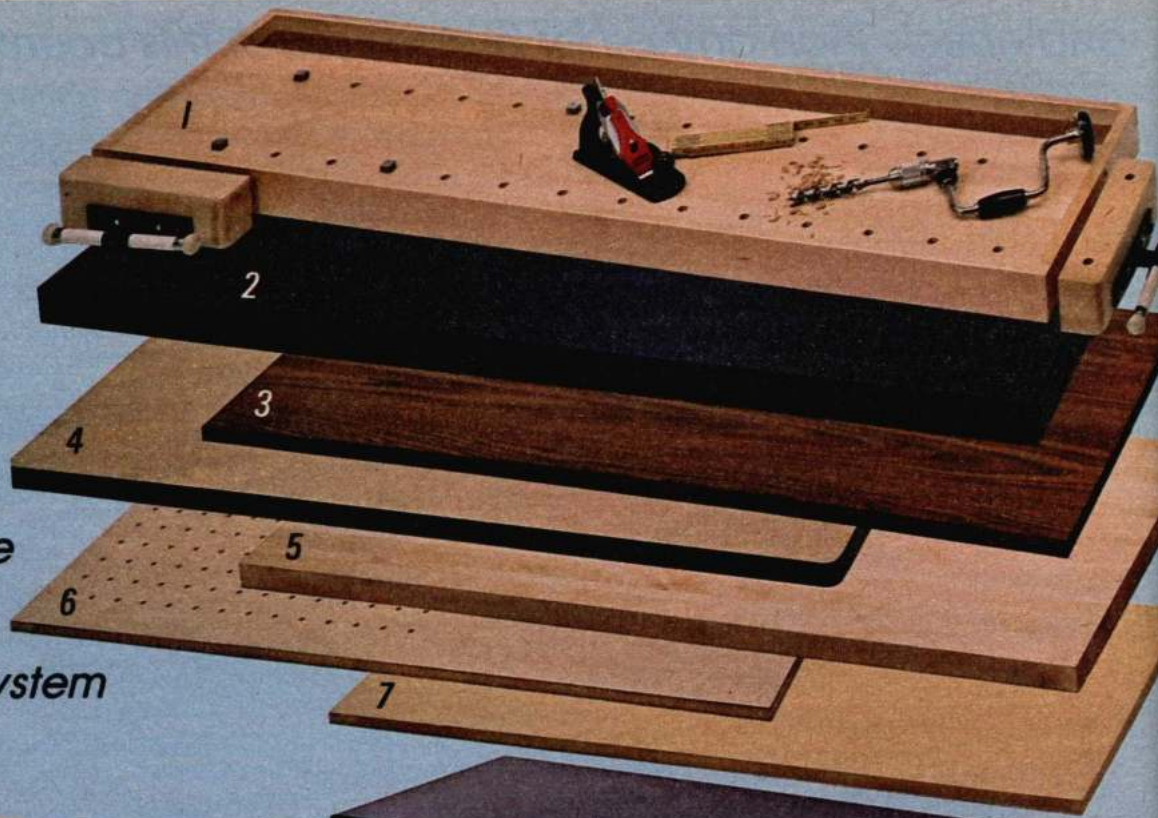

**5-drawer Workbench Base has 10 sq. ft. of storage space**



**10-drawer Workbench Base has 20 sq. ft. of storage space**

**1 thru 7** Just choose a workbench base, then match it with the top that best suits your needs. Each top fits both bases! See "N" suffix note on page 148.

**1** For the woodcrafter, we offer this sanded and lacquered, 1½-in. thick solid beechwood top with 3-in. edging, two 5-in. vises and built-in clamping pegs. Convenient full-length tool tray. 3¾ in. wide x 3 in. deep. 20x69x3 inches thick\*  
9 R 65548N—Shpg. wt. 78 lbs. . . \$179.99

**2** If your specialty is car or truck repair, this heavy-gauge steel top is just what you need. Reinforced for added strength. 24x72x2 in. thick\*  
9 R 65546N—Shpg. wt. 55 lbs. . . \$79.99

**3** Teaching your kids or creating something just for yourself will be easier with this top of industrial-grade particle board with a Formica® laminated plastic woodgrain cover 24x60x1 in.\*  
9 R 65545N—Shpg. wt. 45 lbs. . . \$49.99  
\*Dimensions are approximate.

**4** Serious hobbyists may prefer this industrial grade stained hardwood top with rounded corners and banded edges. 24x60x2 in. thick\*  
9 R 65544N—Shpg. wt. 65 lbs. . . \$59.99

**5** If your work is more the executive type, yet you need lots of elbow room, this butcher block top is for you. It's solid maple with a strong welded wood construction. 24x60x2 in.\*  
9 R 65547N—Shpg. wt. 70 lbs. . . \$99.99

**6** Advanced "do-it-yourselfers" will appreciate this industrial-grade hardboard top with our Critt® Vise surface clamping system. Reversible top. 20x54x1 in. thick\*  
9 R 65543C—Shpg. wt. 30 lbs. . . \$29.99

**5-drawer workbench base with your choice of Tops**

Outfit	Catalog No.	Shpg. wt.	Price
Base (8), Top (1) . . .	9 R 65558N	156 lbs.	\$279.99
Base (8), Top (2) . . .	9 R 65556N	133 lbs.	179.99
Base (8), Top (3) . . .	9 R 65555N	123 lbs.	149.99
Base (8), Top (4) . . .	9 R 65554N	143 lbs.	159.99
Base (8), Top (5) . . .	9 R 65557N	148 lbs.	199.99
Base (8), Top (6) . . .	9 R 65553N	108 lbs.	129.99
Base (8), Top (7) . . .	9 R 65552N	108 lbs.	119.99

**7** This reversible heavy-duty hardboard top is great for the weekend do-it-yourselfer. 20x54x1 in. thick\*  
9 R 65542N—Shpg. wt. 30 lbs. . . \$19.99

**8 and 9** Rugged Workbench Bases of heavy-gauge steel have our exclusive I-FRAME® construction. 2 supporting braces in the center for solid stability. Each can carry loads up to 1450 lbs. Drawers are 17x16 in. Tops not incl. 33 in. high. Unassembled.

**8** 5-drawer Workbench includes 18x16 in. steel shelf. Steel door with hasp. Drawers are 4-in. deep.  
9 R 65561N—Shpg. wt. 78 lbs. . . \$109.99

**9** 10-drawer Workbench base. 4 drawers, 2 in. deep; 4 drawers, 6 in. deep; 2 drawers, 9 in. deep.  
9 R 65564N—Shpg. wt. 102 lbs. . . \$159.99

**10-drawer workbench base with your choice of Tops**

Outfit	Catalog No.	Shpg. wt.	Price
Base (9), top (1) . . .	9 R 65608N	180 lbs.	\$329.99
Base (9), top (2) . . .	9 R 65606N	157 lbs.	229.99
Base (9), top (3) . . .	9 R 65605N	147 lbs.	199.99
Base (9), top (4) . . .	9 R 65604N	167 lbs.	209.99
Base (9), top (5) . . .	9 R 65607N	172 lbs.	249.99
Base (9), top (6) . . .	9 R 65603N	132 lbs.	179.99
Base (9), top (7) . . .	9 R 65602N	132 lbs.	169.99

# Every CRAFTSMAN® workbench with sides features our exclusive I-FRAME® construction that stands up to 50% more stress than conventional flat designs

- Rugged 1450-lb. load capacity
- Drawers have compound-action slides with third rail for smooth opening under weight

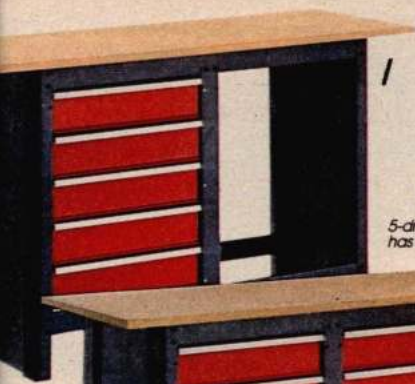

5-drawer workbench has 9.3 sq. ft. of storage

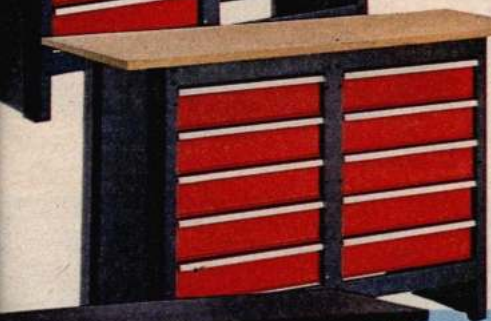

10-drawer workbench has 18.8 sq. ft. of storage



12-drawer workbench has 22.2 sq. ft. of storage



5



6 Heavy-duty workbench chair



Workbench stool

Our most rugged heavy-duty workbench outfit has 15 sq. ft. of storage

- ✓ Heavy-duty all-steel base and 2 supporting center legs
- ✓ Leveling feet adjust height
- ✓ Shelf area has steel back and lockable steel door with key

Each unit offers 7.5 sq. ft. of work surface and stands 34 in. high. Industrial-grade hardboard tops. Steel bases.

**\$10 MONTHLY.\*\* Full sided workbench has 20x54x1-in. thick reversible top. Drawers 16x17x4 in. deep. Includes shelf 18x16 in. wide.\*†**  
9 R 10382N—Shpg. wt. 102 lbs. . . \$149.99

**\$10 MONTHLY.\*\* Full sided workbench has 20x54x1-in. thick reversible top. Drawers are 16x17x4 in. deep.\*†**  
9 R 10277N—Shpg. wt. 133 lbs. . . \$199.99

**\$12 MONTHLY.\*\* Standard workbench has 20x54x2-in. thick top that reverses for extra years of use. Drawers 16x17 in. wide: four, 2 in. deep, eight, 4 in. deep.\*†**  
9 R 10397N—Shpg. wt. 150 lbs. . . \$249.99

Workbench stool has heavy-gauge steel frame. 12¼x9¾x¾-in. thick seat with adjustable back brace. 34¾ inches to top of back. Non-slip, non-marring floor pads. Includes hex key.\*†  
9 R 10296C—Shpg. wt. 9 lbs. 12 oz. . . \$14.99

**\$14 MONTHLY.\*\* This CRAFTSMAN workbench has an extra-wide 30x72x2-in. thick industrial-grade hardboard top with rounded corners and banded edges. Drawers are 16x17-in. wide: two, 2-in. deep, four, 4-in. deep, one, 9-in. deep. More drawers may be added to open center frame. Steel shelf area has steel back panel. Lockable steel door with key. 34 inches high.\*†**  
9 R 10388N—Shpg. wt. 200 lbs. . . \$349.99

Deluxe workbench chair of heavy-gauge steel is designed for comfort and durability. Chair adjusts 3 ways to give proper back support. Height adjusts hydraulically from 18 to 35½ in. high. Sturdy one-piece welded frame has 5-point base for stability. Seat and back of molded urethane with steel inner support and impact spring for comfort. Allow 18 days for delivery. No C.O.D. orders.  
F 9 R 65581—Shpg. wt. 27 lbs. . . \$99.99

Full sided steel workbench can hold up to ten 4-inch deep drawers, ten shelves or any combination you choose up to ten. Two 2-in. deep drawers can be substituted for one 4-in. deep drawer. Accepts all storage components sold at right. 33-inch high table has reversible 20x54x1-in. thick industrial grade hardboard top.\*† See "N" suffix note, page 148.  
9 R 10269N—Shpg. wt. 63 lbs. . . \$89.99

Sideless shelf-style workbench has steel legs and brackets that allow you to mount 2 drawers under top (drawers shown not incl., accepts storage components sold below). 32-inch high table has 20x54x1-in. thick industrial grade hardboard top.\*† See "N" note, p. 148.  
9 R 10267N—Shpg. wt. 46 lbs. . . \$49.99

Steel drawers have compound-action, heavy-duty slides with third rail for smooth operation. 16x17 in. wide.\*

Item	Depth (in.)	Red finish	Wt.		Price	Charcoal finish	Wt.		Price
			lbs.	oz.			lbs.	oz.	
(9)	2½	9 R 10219	5	12	\$14.99	9 R 10341	5	12	\$16.99
(10)	4¾	9 R 10326	8	11	19.99	9 R 10342	9	11	21.99
(11)	9	9 R 10214	10	11	24.99	9 R 10343	9	15	29.99

Steel shelf is 18x16 in. long.\*  
9 R 10347—Shpg. wt. 4 lbs. . . \$9.99

Sliding steel drawer tray fits drawers (9 thru 11). Has dividers that slide into drawer.  
9 R 10213—Shpg. wt. 2 lbs. 6 oz. . . \$10.99

Steel drawer dividers. For 4-in. deep drawers.  
9 R 10211—Shpg. wt. 3 lbs. 10 oz. . . \$11.99  
For 9-inch and 13-inch deep drawers.  
9 R 10212—Shpg. wt. 3 lbs. 4 oz. . . \$11.99

Steel door with hasp is 21x24 in. high.  
9 R 10338C—Shpg. wt. 7 lbs. . . \$14.99

Steel door with tumbler lock. 21x24 in. high.  
9 R 10339C—Shpg. wt. 8 lbs. 8 oz. . . \$15.99

Lock bar for workbench security (lock not incl.).  
9 R 65415—Shpg. wt. 1 lb. 8 oz. . . \$6.99

Expand your work area only when you need it with this wall mount workbench. 20x54x½-in. thick industrial grade hardboard top and steel shelves provide 7.5 sq. ft. of storage. 36-inch legs. Folds up out of the way when not in use.  
9 R 65355C—Shpg. wt. 65 lbs. . . \$59.99

A sheet of plywood mounted to these strong, attractive, enamel-finished legs makes a sturdy portable table for home, school, church, almost anywhere. Hardware included. 35½ inches high.  
9 R 65589C—Wt. 11 lbs. . . Pair \$19.99

\*Dimensions are approximate †Unassembled  
\*\*See p. 148.



7



9

Customize your work area with these accessories



8



12



11



13



14



15



16



Steel workbench legs for instant extra work area

17



35



This soft sides Tool Case has inside and outside storage

Heavy-duty Case holds up to 50 lbs. of tools



Attaché Case with removable pallets



Handle makes it easy to carry

Pick-up Tool Case hides behind seat . . . holds 50 lbs.

5



Leather-look Tool Attaché includes 99-pc. Tool Set



Anchor this TUFF CHEST in your boat or van . . . It releases easily for tool storage in your workshop or garage

1

## Portable storage for "Tools on the Go"

Get the security of a steel chest in lightweight **Structurolene®**, an industrial-strength plastic. This tough tool chest won't rust, dent or chip. Water-tight one-piece bottom and side construction with full length piano hinged top for strength and durability. Removable heavy-duty utility tray, sliding tool tray and molded-in handles. Lock, 2 keys included. Overall 35x14x13 in. deep. 9 R 65138C—Shpg. wt. 26 lbs. . . \$49.99

6 \$13 monthly, see p. 148. This 99-pc. tool set includes most everything you'll need conveniently stored in this leather look thermo-plastic attaché case (same case as (4) sold at left). Set includes:  $\frac{1}{4}$ -in. square drive quick release ratchet with spinner handle, 3 extension bars (1½, 3, 6 in.); nine 6-pt. sockets ( $\frac{3}{16}$  thru  $\frac{1}{2}$  in.) with storage case,  $\frac{3}{8}$ -in. square drive quick release ratchet with 2 extension bars (3, 6 in.); eight 12-pt. sockets, ( $\frac{3}{16}$  thru  $\frac{3}{8}$  in.); six 6-pt. sockets ( $\frac{3}{8}$  thru  $\frac{1}{2}$  in.), and socket rack. Also includes: 9 combination wrenches ( $\frac{1}{4}$  thru  $\frac{1}{2}$  in.); adjustable wrench, 8 open-end ignition wrenches ( $\frac{7}{32}$  thru  $\frac{1}{2}$  in.); 10 combination ignition wrenches ( $\frac{9}{32}$  thru  $\frac{3}{8}$  thru  $\frac{7}{16}$  in.), 7 nutdrivers ( $\frac{3}{16}$  thru  $\frac{1}{2}$  in.), 10 screwdrivers, 14-pc. hex key set, 6 pliers and hammer. Tools are warranted by Sears. To write for free copy, see page 148. 9 R 46397C—Shpg. wt. 23 lbs. . . \$299.00

7 Handsome tool carrier of Cordura nylon, Texon and Neoluxe plastics holds up to 29 tools (not incl.) and your test meter. Large outside pocket holds documents. Sturdy web handles and heavy-duty industrial zipper. 13x10x2½ in. deep overall. 9 R 65131—Shpg. wt. 2 lbs. 12 oz. . . \$39.99

Cordura nylon carrier above with 8-pc. tool set. Includes: 3 slotted screwdrivers ( $\frac{1}{8}$ x2,  $\frac{3}{16}$ x4,  $\frac{1}{4}$ x6 in.), No. 2 Phillips screwdriver, pocket screwdriver, 6-inch long-nose pliers, 9-inch Arc Joint® pliers, 6-inch adjustable wrench. 9 R 65137—Shpg. wt. 5 lbs. 5 oz. . . \$69.99

8 Versatile vinyl tool case has Velcro closures for easy ins and outs. Flat briefcase look easily stores in small areas such as under your car seat, or stand it upright on its flat base. Carries a Velcro attached piggyback pouch that lets you carry a smaller amount of tools. 14x11x2¾ in. wide overall. 9 R 65135—Shpg. wt. 1 lb. 15 oz. . . \$29.99

9 Soft vinyl roll up tool pouch provides compact storage, perfect for the car. 18 clear plastic compartments hold a variety of tools (tools not incl.). 2 Velcro closures. 29x26 in. wide unrolled. 9 R 65134—Shpg. wt. 13 oz. . . \$17.99

2 Tool tote has the look of soft sides luggage. Lightweight Cordura nylon is water-resistant. Heavy-duty industrial zipper and double nylon web handles. 2 outside expandable pockets, 6x10x2½ in., hold test meters or spare parts. Wide outside pocket, 10x6x2½ in. for manuals and paperwork. Overall 15x12x7 in. deep. 9 R 65143—Shpg. wt. 4 lbs. . . \$59.99

3 Attaché tool case of high-impact polyethylene has extra heavy duty aluminum frame. Hand-stitched pallets organize as much as 50 lbs. of tools. Extra storage space in bottom for spare parts, meter, etc. Full-length piano hinge and sturdy molded-on feet. Comfortably padded steel core handle. All hardware is riveted through frame. Overall 18x13x6 in. deep. 9 R 65132—Shpg. wt. 11 lbs. . . \$99.00

8-in. deep attaché case similar to above. 9 R 65133—Shpg. wt. 12 lbs. . . \$109.99

4 Leather-look thermo-plastic attaché tool case has fiberglass reinforced corners. 2 removable pallets have 31 plastic piggybacks, holds tools such as screwdrivers, wrenches (not incl.). Bottom dividers for separating larger tools. Overall 18x13x6 in. deep. 9 R 65091—Shpg. wt. 10 lbs. 2 oz. . . \$79.99

5 Pick-up truck tool box is designed to allow you to keep your precious tools behind the seats out of sight. Large enough to carry most tools. High density polypropylene box is rust-proof and impact resistant. Holds up to 50 lbs. of tools and can be wall mounted for home or shop use. Overall 24x17½x5½ in. deep. 9 R 65136—Shpg. wt. 7 lbs. . . \$19.99



Water resistant Cordura® nylon Tool Carrier



7



Vinyl Tool Case has Velcro™ closures and piggyback case

8

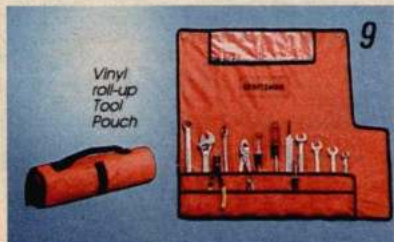

Vinyl roll-up Tool Pouch

9

ONE QUALITY NAME

**CRAFTSMAN**

OFFERS MORE GOOD CHOICES

# CRAFTSMAN Compact Portable Generators offer the convenience of electrical power, indoors or out, at home or away

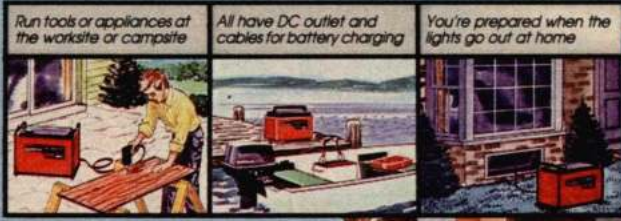

Run tools or appliances at the worksite or campsite

All have DC outlet and cables for battery charging

You're prepared when the lights go out at home

Best of all, they're designed with you in mind!

- ✓ All have large mufflers for extra-quiet operation
- ✓ Easy-to-carry design features a fully-enclosed case with cushioned handles
- ✓ Built-in circuit breakers won't allow over-powering of appliances

Super-compact  
750-watt  
Portable Generator  
**\$429<sup>99</sup>**



2400-watt  
Compact  
Portable Generator  
**\$729<sup>99</sup>**

1 and 2 As little as \$15 or \$27 monthly, see p. 148, will buy one of our Craftsman compact portable generators, designed to give you high wattage output and super-quiet operation. Spark arrest mufflers meet USDA standards for use in National Forests and campgrounds. All have easy-access to oil fill and service drain. Large gas tanks mean longer running time before refilling. Simultaneous AC/DC outlets keep you from juggling tools and appliances. DC outlet and cables for battery charging. Non-vibration rubber mounts reduce noise and wear. 25% extra surge capacity supplies the power you need to start-up certain tools and appliances. Metal case. Warranted by Sears. Write for free copy, see p. 148. Order from chart below.

1 750-watt super-compact portable generator weighs only 49 pounds, is easier to carry to the boat or campsite. Manual recoil starter and automatic throttle. Two 120-v. outlets.

2 Manual recoil start has compression release. Indicator light. Two 120-v. outlets, 3600-watt unit also has one 120-v. outlet and one 240-v. outlet that allows use of full wattage capacity, lets you use one large wattage appliance.

Wheel kit for (2) allows easy portability.  
9 R 32218—Shpg. wt. 8 lbs. . . \$36.99

3 and 4 Both available at Sears in catalog only. As little as \$50 or \$68 monthly, see p. 148, will buy one of our most powerful, heavy-duty generators. Electric-start requires 12-volt battery (not incl.), units can also be started manually. Extra-large mufflers for quiet operation. Indicator lights. Two 120-v., 20-amp outlets, one twist-lock 120-v., 30-amp outlet and one twist-lock full-capacity 240-v. outlet. (4) includes wheel and handles for portability. Order wheel kit for (3) sold below. Warranted by Sears. Write for free copy, see p. 148. Order generators from chart below.

Wheel kit for (3) allows easy portability.  
9 R 32219—Shpg. wt. 8 lbs. . . \$79.99

For demanding farm and construction work, our Heavy-duty Generators can supply the power you need to get the job done



5000-watt  
Generator  
**\$1399<sup>99</sup>**



7500-watt  
Generator  
**\$1899<sup>99</sup>**

Key	Watts		Vtg.	HP	Fuel tank		Running time, hrs.*		Amps at 120-volts	Dbat at 20 ft.	LxWxH, in.*	Catalog Number	Wt. lbs.	Price
	Rated	Surge			Full load	1/2-load								
(1)	750	950	Sgl.	1.6	8 gals.	4	8	6.3	58	16x11x14	9 R 32831C	53	\$429.99	
(2)	1400	1750	Sgl.	3	2.3 gals.	6	12	11.7	64	21x14x18	9 R 32832N	88	\$29.99	
	2400	3000	Sgl.	5	2.3 gals.	4	7	20.0	67	21x14x18	9 R 32833N	100	729.99	
	3600	4500	Dual	7	4.5 gals.	5	9	30.0	66	25x16x21	9 R 32834N	153	949.99	
(3)	5000 <sup>▲</sup>	6250	Dual	11	4.5 gals.	4.5	6	41.7	77	29x18x24	9 R 32835N	180	1399.99	
(4)	7500 <sup>▲</sup>	8800	Dual	18	4.5 gals.	4	5.5	62.5	79	30x20x25	9 R 32836N	190	1899.99	

\*Approximate †Decibels

▲National Electric Code requires ground-fault interruptor for generators 5000 watts or higher if used on construction sites. We recommend it for all uses.

## How to select the proper generator:

- ✓ Consider the combined wattage of the items you want to run and then add a 25% safety factor.
- ✓ To determine wattage, simply multiply the volts of each tool by the amps. Volts x amps = watts
- ✓ Be sure to check owner's manuals of your tools and appliances for power requirements and the additional wattage some motors need to start-up.

Economical worklight has shatter-resistant lightweight plastic head



2

Worklights—as essential to the job as having the proper tools

Metal head protects bulb from contacting hard surfaces



3

Retract-O-Matic™ cord reels provide the exact length of cord needed... ends the problem of tangled, hard-to-store extension cords



Pull out only the length you need... another pull and it's back out of your way. Mounts easily to wall or ceiling. Custom accessories (below) turn Retract-O-Matic™ cord-reel into multi-outlet power adapters and worklights... eliminates the need for separate lights and cords

Just mate plugs

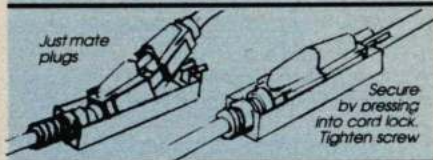

Secure by dressing into cord lock. Tighten screw

Cord lock feature helps prevent unwanted cord disconnects by locking cords together for safety and convenience. Molded housing helps eliminate strain on plugs and cords

Retract-O-Matic™ cord reels are part of a multipurpose cord system that provides worklights and outlets without the inconvenience of storing long, bulky cords for each tool. Accessories plug directly into cord to form new tool. Lock in place to prevent accidental disconnects. Single outlet 3-wire cord. Warr. by Sears, write for free copy, see p. 148.

Cord lgth.	Wire size	Catalog Number	Shpg. wt.		Price
			lbs.	oz.	
20-ft.	18/3	9 R 83951	3	12	\$16.99
30-ft.	16/3	9 R 83952	9	9	20.99
30-ft.	14/3	9 R 83953	9	8	39.99

Pivoting magnetic worklight attaches to any steel surface



4

Automotive worklight operates from 12-v. car battery... ideal for emergency repairs



5

Worklight has super-tough, oil and water resistant cord that remains flexible to -60°F

3-outlet Adapter



9

Power block Adapter



10

Retractable reel stores cord out of your way



6

Fluorescent worklight provides bright, even illumination



7

Fluorescent reel light stores up to 40-ft. of cord out of way until needed



8

Metal guard worklight



11

Plastic guard worklight



12

Fluorescent worklight



13

Save 20%

on any 2 or more accessories when you also buy Retract-O-Matic™ Cord Reel

1 Our best worklight has 25-ft., 16-ga. 3-wire solar/polar all-weather cord that remains flexible to -60°F and is resistant to oil and water. Metal bulb guard/reflector. Grounded outlet on handle. Takes max. 75-w. bulb (not incl.). \* UL listed. 9 R 83904—Shipping weight 2 lbs. 2 oz. . . \$10.99

2 Economical light has durable plastic head and 25 ft., 18 ga., 2-wire cord. Takes max. 75-watt bulb (not incl.). \* UL listed. 9 R 83901—Shipping weight 2 lbs. 2 oz. . . \$5.49

3 Worklight has metal bulb guard/reflector, grounded outlet on handle and 25-ft. heavy-duty 16 ga., 3-wire cord. Takes max. 75-w. bulb (not incl.). \* UL listed. 9 R 83902—Shipping weight 2 lbs. 2 oz. . . \$9.49

4 Worklight adjusts to different angles for easier positioning. Swivel base has magnet with 50 lb. pull for securely gripping steel surfaces. Durable plastic shell. Grounded outlet in handle. 25-ft., 18-ga. 3-wire cord. Uses max. 75-w. bulb (not incl.). \* UL listed. 9 R 83922—Shipping weight 2 lbs. 8 oz. . . \$18.99

\*Bulbs available in 1988 Annual Catalog, p.47A.

5 Automotive worklight with 15 ft. coiled cord plugs into 12-v. cigarette lighter or clamps to car battery. Swiveling magnetic base attaches to any steel surface. Durable plastic shell. Battery clamps, storage bag incl. 9 R 83924—Shipping weight 1 lb. 13 oz. . . \$18.99

6 Worklight has retractable reel that locks, rewinds cord automatically. Grounded outlet in handle. Metal bulb guard. Uses max. 75-w. bulb (not incl.). \* 18-ga., 3-wire cord. UL listed. 9 R 83914—20-ft. cord. Shpg. wt. 4 lbs. . . \$15.99 9 R 5923—35-ft. cord. Wt. 9 lbs. 4 oz. . . \$27.99

Worklight like above with solar/polar all-weather cord that remains flexible to -60°F. 9 R 83906—Shipping weight 9 lbs. 4 oz. . . \$32.99

7 Fluorescent worklight has rubberized plastic case with hooks for vertical, horizontal hanging. 25-ft., 18-ga. 2-wire cord, ground plug from ballast. 15 w. bulb incl. On/off switch. UL listed. 9 R 5926C—Shipping weight 3 lbs. 4 oz. . . \$18.99

8 Fluorescent worklight (similar to above) with automatic reel that locks, rewinds. 9 R 83916C—25-ft. cord. Wt. 7 lbs. 8 oz. . . \$27.99 9 R 5931C—40-ft. cord. Wt. 11 lbs. 3 oz. . . \$39.99

Accessories ideal for use with Retract-O-Matic™ cord reel. Worklights, for indoor use only, have grounded outlet in handle, take up to 75-w. bulb (not incl.). \* Fluorescent worklight has 15-w. bulb (incl.), multi-position hook, push button switch and 2 wire cord. (9, 10) have 3 grounded outlets. All except (13) have heavy-duty rubberized cord with grounded plug. UL listed AC.

Item no.	Catalog Number	Shpg. wt. ea.		Each	2 or more w/cord reel
		lb.	oz.		
(9)	9 R 83954	3	4.99	Ea. \$3.99	
(10)	9 R 83956	6	8.99	Ea. 7.19	
(11)	9 R 83957	13	9.99	Ea. 7.99	
(12)	9 R 83958	11	8.99	Ea. 7.19	
(13)	9 R 83959	1	19.99	Ea. 15.99	

# Make the job easier with CRAFTSMAN® general-purpose automotive repair tools



**Screw extractor kit** removes broken studs, set screws, pipe and alemite fittings. Includes 5 alloy steel extractors. Wt. 6 oz. 9 R 42015... \$11.99



**Muffler and tailpipe cut-off tool**

Tool has 4 cutting wheels with 1½ to 2½-in. diameter range. Shpg. wt. 1 lb. 7 oz. 9 R 47607... \$13.99

**Available only in Catalog!** Set of 4 replacement wheels for tool above. Not Craftsman. Shpg. wt. 2 oz. 9 R 47611... Set \$3.99



**Harmonic balancer, steering wheel puller** removes balancers, pulleys, gears without damaging shaft threads. 9 R 47626—Wt. 2 lbs. 7 oz... \$13.99



**2-arm gear puller** with forged high-carbon boron steel reversible arms. 0 to 6-in. arm spread with 3½-in. reach. Handles up to 5 tons. 9 R 46905—Wt. 2 lbs. 13 oz... \$17.99  
0 to 8-in. arm spread with 6-in. reach. Handles up to 7 tons. 9 R 46903—Wt. 3 lbs. 8 oz... \$22.99

**Adjustable arm gear puller** functions as 2-arm or 3-arm gear puller for more balance. 0 to 6-in. arm spread with 3½-in. reach. 5-ton capacity. 9 R 46906—Wt. 2 lbs. 10 oz... \$32.99  
**Available only in Catalog!** 0 to 8-in. arm spread with 6½-in. reach. Handles up to 7 tons. 9 R 46904—Wt. 6 lbs. 8 oz... \$44.99



**Available only in Catalog!** Tail pipe expander has a 1½ to 2½-in. range. Use with wrench or impact tool. Wt. 2 lbs. 12 oz. 9 R 47606... \$11.99

**Parts cleaning brush** removes grease and dirt from auto parts. Shpg. wt. 4 oz. 9 R 41802... \$2.99



**3 2½-in. wire cup brush** removes light scale, rust, paint from flat surface. For light use only. Use with ¼-in. electric drill (not incl.). Wear safety glasses. 9 R 41805—Wt. 5 oz... \$5.99

**4 1-in. knot-type wire end brush** removes rust, carbon and paint from metal. Use with ¼-in. electric drill (not incl.). Wear safety glasses. 9 R 41803—Wt. 5 oz... \$5.99



**5 Magnetic pickup tool/stud finder** retrieves small metal parts. Incl. pocket clip. 5½ in. long. 9 R 4001—Shpg. wt. 1 oz... \$2.99

**6 Magnetic telescoping pickup tool** extends 16¾ to 26¾-in. long. Double ball and socket joint gives full 360° flexibility. 9 R 4132—Shpg. wt. 7 oz... \$4.99  
Pickup tool like above extends from 4½ to 19¼ in. Pocket clip. 9 R 4133—Wt. 1 oz... \$3.49



**Hand impact driver set** includes ½-in. square drive tool; adapter; Nos. 2, 3, 4 Phillips; ⅜-in. slotted bits and pouch. Each impact turns bit up to 20°. Shpg. wt. 2 lbs. 1 oz. 9 R 47641... Set \$16.99

**Phillips replacement bits for above.**

Type	Catalog No.	Wt.	Price
No. 1	9 R 47631	1 oz.	\$1.49
No. 2	9 R 47635	1 oz.	1.49
No. 3	9 R 47632	1 oz.	1.49
No. 4	9 R 47636	1 oz.	1.49

**Straight-slotted bit.** ⅜ in. 9 R 47637 1 oz. \$1.49



**5-pc. Specialty tool kit** incl. inspection mirror, telescoping magnetic pickup tool, double-pointed scribe with straight and 90° points, slotted and Phillips/Torx® screw starters, storage pouch. Warranted by Sears, write for free copy, see page 148. Shipping weight 6 ounces. 9 R 4717... Kit \$14.99



**Universal nut cracker** splits nuts from ⅝ in. to ⅞ in. across flats with no damage to bolt threads. Forged steel frame, hardened cutter. Use with ¾-in. wrench. Shipping weight 12 ounces. 9 R 4772... \$11.99

**Replacement cutter for above.** Shipping weight 3 ounces. 9 R 4773... \$3.49

**All-purpose scraper/sticker remover** locks into 3 operating positions to reach hard-to-get-at slanting windshields. Shipping weight 5 ounces. 9 R 42016... \$5.99

**General-purpose gasket scraper** includes 3 blades: 1, 1½ and 2 in. wide. Wt. 6 oz. 9 R 47725... \$5.49

**Pkg. of 6 replacement blades** for above has 2 of each size: 1, 1½ and 2 inches wide. 9 R 47729—Wt. 1 oz... Pkg. \$1.99

**Available only in Catalog!** Battery maintenance kit helps keep automotive batteries in top condition. Kit includes battery carrying strap, battery terminal cleaning brush and terminal cable puller for removing corroded terminal clamps. Shpg. wt. 1 lb. 4 oz. 9 R 47625... Set \$19.99



## Engine Rebuilding Tools

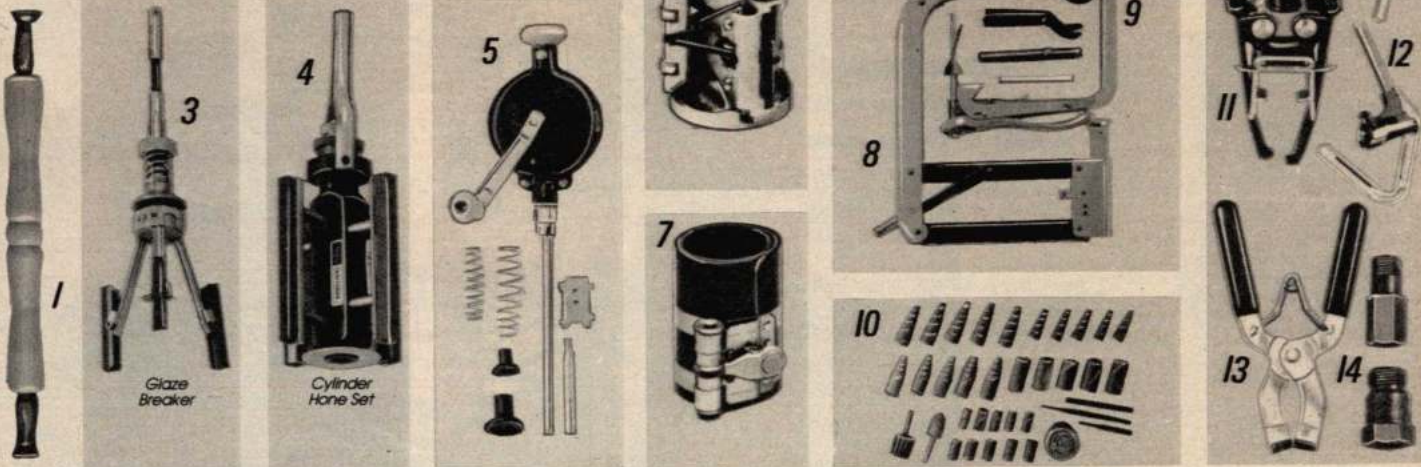

1 and 2 Valve grinders let you hand grind small, large flathead unslotted valves.

1  $\frac{5}{8}$ ,  $\frac{13}{16}$ -in. cup diam. grinder.  
9 R 41381—Wt. 4 oz. . . \$2.99

2  $1\frac{1}{2}$ ,  $1\frac{1}{8}$ -in. cup diam. grinder.  
9 R 41382—Wt. 4 oz. . . \$2.99

3 Glaze breaker works with  $\frac{1}{4}$  in. or larger electric drill (not incl.). Has a range of 2 to 7 in. Includes three 220 grit stones.  
9 R 4633—Wt. 1 lb. 4 oz. . . \$18.99

Replacement set for (3). Set of 3.  
9 R 46331—Wt. 2 oz. . . Set \$5.49

4 Cylinder hone set\* has two 5-in. 180, 80 grit stones and 2 wipers. 3 to 4 $\frac{1}{4}$ -in. range. Universal joint action. Shank, extension fit  $\frac{1}{2}$ -in. drill or drill press (not incl.).  
9 R 4682—Wt. 6 lbs. 11 oz. . . \$99.99

Replacement set for (4) has 2 stones and 2 wipers. Wt. set 7 oz.  
9 R 4687—180 grit . . . \$9.99  
9 R 4686—80 grit . . . \$9.99

5 Valve grinder has reciprocating progressive action. Long, short stems. 2 suction cups, 2 adapters.  
9 R 47042—Wt. 1 lb. 12 oz. . . \$9.99

Abrasive grinding compound for (5).  
9 R 4774—Wt. 1 oz. . . \$2.99

6 Steel scraper-type ridge reamer\* has  $2\frac{1}{16}$  to  $5\frac{1}{16}$ -in. range. Offset guide jaws for rigidity.  
9 R 4725—Wt. 2 lbs. 3 oz. . . \$21.99

Replacement Cutter.  
9 R 4726—Shpg. wt. 1 oz. . . \$4.99

7 Ratchet-type ring compressor for auto, light truck piston rings  $2\frac{1}{2}$  to 5-in. range. Holds up to 4 rings. Key wrench incl. 2 tension bands.  
9 R 4716—Wt. 10 oz. . . \$4.49

8 Heavy-duty valve spring compressor\* with 16x13-inch frame. 10 $\frac{1}{2}$ -inch opening. 6 $\frac{1}{4}$ -inch steel jaws.  
9 R 47622—Wt. 8 lbs. 14 oz. \$24.99

9 Valve spring compressor for GMC, Continental engines. 9x11-in. steel frame. 9 $\frac{1}{2}$ -in. opening. Nos. 1 and 2 spring steel jaws.  
9 R 47627—Wt. 4 lbs. 4 oz. \$12.99

10 36-pc. auto porting kit incl. abrasive flap wheel for grinding, polishing heads and manifold parts. Grinding-polishing rolls (spiral and straight in assorted sizes, grits). Stones for hard-surface cutting, butterfly strip roll for internal polishing. Use with  $\frac{1}{2}$ -in. drill (not included).  
9 R 64866—Wt. 12 oz. Kit \$15.99

11 Universal compressor removes valve spring with overhead valves without removing cylinder head.  
9 R 41384—Wt. 1 lb. 1 oz. \$13.99

12 Piston groove cutter/cleaner\* fits over pistons up to 5-in. diam. 5 pt. sizes for grooving, 1 for trimming.  
9 R 4722—Wt. 15 oz. . . \$12.99

13 Piston ring expander for  $\frac{3}{4}$ -in. to  $\frac{1}{4}$ -in. diam. rings.  
9 R 4662—Wt. 4 oz. . . \$4.49

14 Air-hold fitting set applies air pressure to keep valves closed while servicing a single valve. Fits 14mm and 18mm spark plug holes. Fits standard air hose couplings. Use with (9) and (11) at left.  
9 R 41806—Wt. 4 oz. . . \$3.99  
\*Available at Sears only in catalog.

**SHOP BY PHONE**  
To order, call your local Sears store

## General-purpose Engine Tools

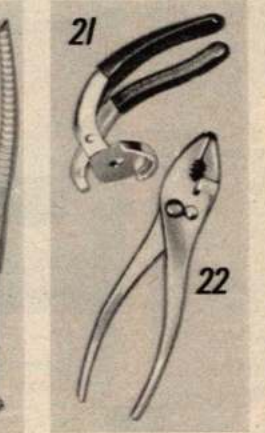
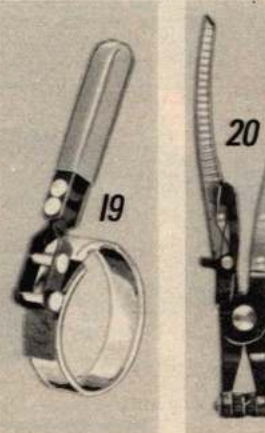
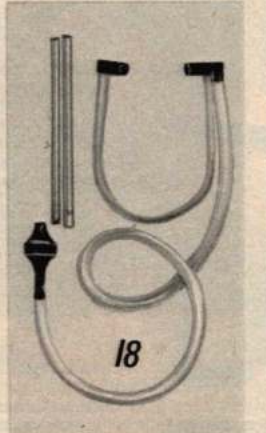
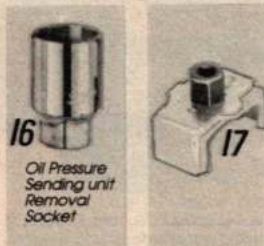
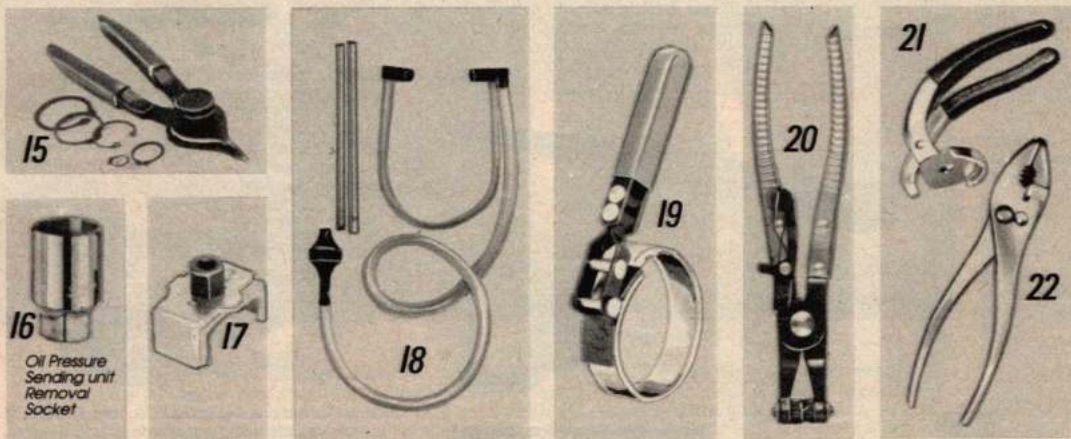

23 and 24  $\frac{3}{8}$ -in. square drive,  $\frac{13}{16}$ -in., 6-pt. spark plug sockets of nickel-chrome plated steel.

Key	Type	Catalog No.	Wt.	Price
(23)	flex	9 R 43323	4 oz.	\$7.29
(24)	reg.	9 R 43325	4 oz.	2.09

25 Available at Sears only in Catalog. Spark plug maintenance kit incl. 14, 18mm spark plug chaser,  $\frac{3}{8}$ -in. and  $\frac{13}{16}$ -in. spark plug sockets ( $\frac{3}{8}$ -in. drive); 6-wire gap gauge and voltage tester.  
9 R 47617—Wt. 1 lb. 4 oz. . . \$14.99

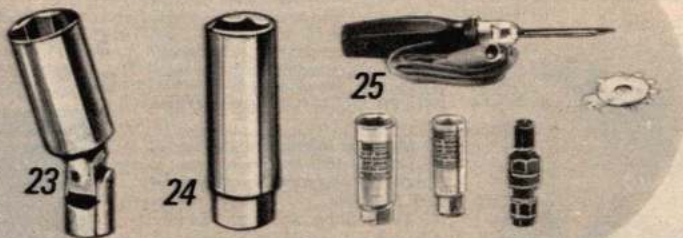

## Spark Plug Tools

15 Snap ring pliers fit internal rings .041 to .062-in., external rings .250 to 1.375-in. diam. Steel, vinyl grips. 5 $\frac{1}{2}$ -in. long. Rings not incl.  
9 R 45359—Shpg. wt. 3 oz. . . \$8.49

16 Oil-pressure sending unit removal socket for Ford, Chrysler engines also fits some brake light switches.  $\frac{3}{8}$ -in. sq. drive with 1 and 1 $\frac{1}{2}$ -in. hex opening.  
9 R 41385—Shpg. wt. 6 oz. . . \$4.99

17 Oil-filter wrench fits 2 $\frac{1}{16}$  to 3 $\frac{1}{16}$  in. diam. filters. Use with  $\frac{3}{8}$ -in. sq. drive tools.  
9 R 46952—Shpg. wt. 11 oz. . . \$4.49

Oil filter wrench like (17) above except fits 3 $\frac{1}{2}$  to 3 $\frac{1}{4}$ -in. filters.  
9 R 46953—Shpg. wt. 11 oz. . . \$4.49

18 Engine stethoscope has ultra-sensitive probe and sound chamber.  
9 R 45161—Shpg. wt. 8 oz. . . \$9.49

19 Oil-filter wrench fits 3 $\frac{1}{2}$ -in. to 3 $\frac{3}{4}$ -in. diam. filters. Non-slip grip.  
9 R 47608—Wt. 12 oz. . . \$3.59

Wrench fits 2 $\frac{7}{8}$  to 3 $\frac{1}{4}$  in. oil filters.  
9 R 47609—Wt. 12 oz. . . \$3.59

20 8-in. long hose clamp pliers of nickel-chrome plated alloy steel.  
9 R 45391—Shpg. wt. 11 oz. . . \$8.49

21 Radiator cap remover loosens caps. Helps keep hands away from hot cap. Not Craftsman.  
9 R 45401—Shpg. wt. 14 oz. . . \$7.99

22 Hose clamp pliers removes or installs ring-type clamps. Alloy steel. 8 in. long.  
9 R 41371—Wt. 7 oz. . . \$6.49

## Brake tools

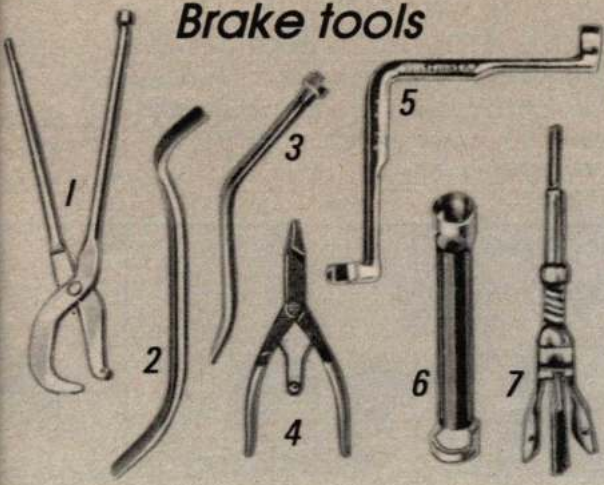

## Clutch alignment tool



**1** Brake spring pliers remove and replace Bendix and Lockheed brake springs. 9 R 46947—Wt. 1 lb. 9 oz. . . \$11.99

**2** Chrome-plated alloy steel brake adjusting tool has 1/2-in. blade. 3/8x9 1/4 in. long. Imported. 9 R 4740—Shpg. wt. 7 oz. . . \$3.49

**3** 9-in. alloy steel brake spring tool is specially designed for easy removal and replacement of Bendix brake shoe return springs. 9 R 46946—Shpg. wt. 6 oz. . . \$7.49

**4** 9-in. chrome-plated alloy steel locking pliers have 1 1/2-in. jaw opening. 9 R 46948—Shpg. wt. 10 oz. . . \$11.99

**5** Steel brake bleeder wrench has 5/16 and 3/8-in. hex ends. For GM, Ford and Chrysler cars. 9 R 4761—Shpg. wt. 4 oz. . . \$6.49

25-blade Master Feeler gauge (not shown) has range of .0015 to .040-in. 9 R 40805—Wt. 11 oz. . . \$15.99

**6** Double-end brake spring tool fits both large and small brake shoe retaining spring washers. 9 R 47761—Shpg. wt. 4 oz. . . \$5.49

**7** Flexible hone has 3 stones to hone and polish brake cylinder. 2 7/32 to 2-in. range. Controlled pressure. 9 R 4656—Shpg. wt. 3 oz. . . \$7.49

Replacement stones for (7). Pkg. of 3. 9 R 4657—Shpg. wt. 1 oz. . . Pkg. \$2.49

**8** 9-pc. clutch aligning set\* has 8 diameters: .590, .612, .624, .688, .749, .786, .808, .964-in. Wt. 1 lb. 3 oz. 9 R 4728 . . . Set \$13.99

**9** Steel offset gauge allows adjustment of "V" engine tappets. 45° offset, 26 blades. .005 to .030-in. Blades stamped with SAE and metric equivalents. Shpg. wt. 1 oz. 9 R 40802 . . . \$4.99

\*Available in Catalog only.

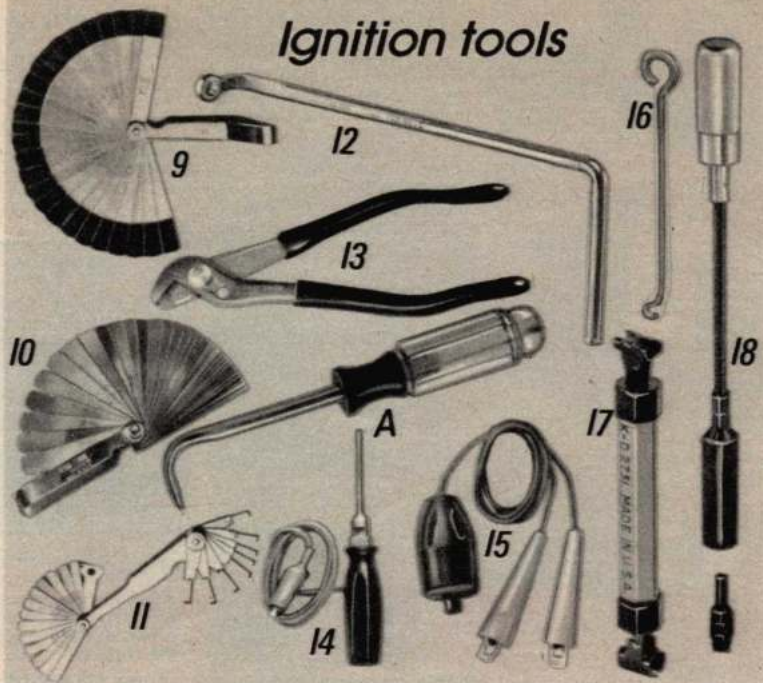

**10** 36-blade combination master gauge has 6 brass blades. Incl. sizes .002-in./ .05mm thru .035-in./ .89mm. 9 R 40811—Shpg. wt. 5 oz. . . \$4.99

**11** Steel ignition gauge has 14 blades (.012-in./ .30mm thru .032-in./ .81mm) and 8 wires (.020-in./ .50mm thru .040-in./ 1.02mm. Not Craftsman. 9 R 40801—Shpg. wt. 2 oz. . . \$2.99

**12** Standard and metric distributor wrenches feature offset design for easy access to mounting bolt.

Opening	Catalog No.	Wt.	Price
10mm	9 R 47674	9 oz.	\$7.49
12mm	9 R 47675	9 oz.	7.49
13mm	9 R 47676	11 oz.	7.49
17mm	9 R 47677	11 oz.	7.49
1/2-in.	9 R 47682	11 oz.	7.49
3/4-in.	9 R 47683	11 oz.	7.49

**13** 5-in. ignition pliers have 1/2-in. max. parallel jaw opening. Has 3 adjustments. Alloy steel construction. 9 R 4513—Shpg. wt. 2 oz. . . \$4.49

**14** High-low voltage tube checks 6, 12-v. circuits; spark plugs. 9 R 41388—Shpg. wt. 5 oz. . . \$7.49

**15** Remote control starter switch bypasses ignition switch on engines with solenoid starter switch. 9 R 41387—Shpg. wt. 11 oz. . . \$8.49

**16** Spark plug boot puller removes recessed boots on GM X, A, J car engines without damaging wires. 9 R 47678—Shpg. wt. 2 oz. . . \$1.59

**17** Double-ended fuse puller removes and replaces glass tube and plastic blade type fuses. Shpg. wt. 1 oz. 9 R 47673 . . . \$2.29

**18** Distributor and carburetor adjustment tool has flexible metal shaft for access to hard-to-reach places. Incl. hooded slotted bit for carburetor adjustments. Shpg. wt. 3 oz. 9 R 47685 . . . \$6.49

**19** Wheel puller pulls steering wheels on most U.S. and imported cars. Incl. 5 sets of side bolts: 3/8-16, 1/2-18, 5/16-24, 1/4-28, 8mm. Shpg. wt. 2 lbs. 1 oz. 9 R 47023 . . . \$17.99

**20** Oil, grease seal puller with 2 different tip sizes. Shpg. wt. 13 oz. 9 R 47645 . . . \$5.49

**23** Flywheel puller\* with 3-in. reach takes diam. up to 6 in. 9 R 47163—Wt. 3 lbs. . . \$14.99

**24** Ring compressor\* has 1 1/4 to 3 1/2-in. capacity. Compresses all rings at once. 9 R 47161—Wt. 8 oz. . . \$3.99

**25** Magnetic key inserter\* holds split keys and locking pins for Briggs & Stratton® engines. 9 R 47164—Wt. 2 oz. . . \$3.99

**26** Steel valve spring compressor.\* 9 R 47621—Wt. 13 oz. . . \$8.99

**27** Ridge reamer\* with extra carbon steel blade 2-3-in. range. 9 R 4710—Wt. 14 oz. . . \$26.99

**21** Maintain good contact between cables and battery with this post and cable cleaner. Has steel brushes to help remove corrosion from posts and inside of cable clamps. 9 R 4767—Shpg. wt. 3 oz. . . \$2.69

**22** Cable remover removes frozen or corroded cable terminals from battery. 9 R 47672—Shpg. wt. 13 oz. . . \$5.49

**28** Piston ring expander\* has 1 1/4 to 2 1/4-in. cap. 9 R 47162—Wt. 10 oz. . . \$4.99

**29** Cylinder hone\* has adjusting knob to control pressure in cylinder from 1 1/2 to 2 3/4-in. 180 grit. 9 R 47623—Wt. 5 oz. . . \$6.99

Repl. stone for (29) above. 9 R 47624—Wt. 1 oz. . . \$2.99  
Small engine tool set\* incl. (23 thru 29), groove cutter, valve grinder, refacer, valve grinding stick with 3/4-in. cap. 9 R 47628C—Wt. 10 lbs. . . Set \$89.99

**A** Cotter key puller has chrome-plated steel hook and fluted butyrate plastic handle. 9 R 4319—Shpg. wt. 3 oz. . . \$3.99

## Steering wheel, bearing and battery tools

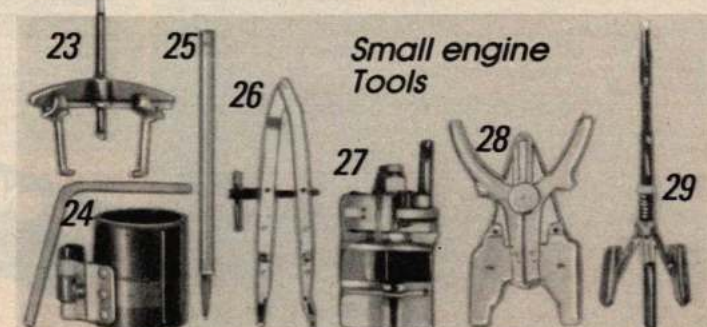
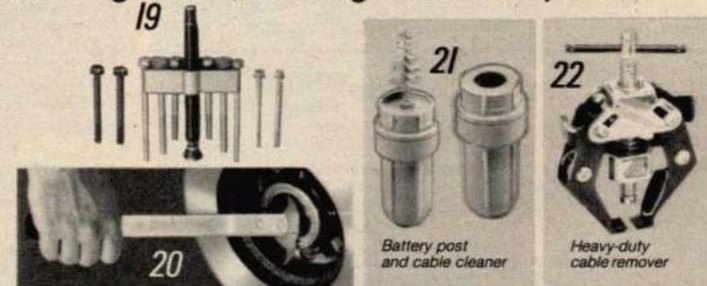

## Small engine Tools



Inflator/compressor delivers up to 120 PSI for fast inflation of tires, sporting goods and more!

**\$67<sup>99</sup>**



Power-packed CRAFTSMAN compact air compressors need no oil for operation... they're lightweight, easy to carry and store!

**\$109<sup>99</sup>** and up



CRAFTSMAN good-quality electric air compressors have all the power of compact units, the convenience of oilless design, PLUS an air storage tank so you finish jobs even faster!

**\$179<sup>99</sup>** and up

1 Compact unit operates up to 5 times faster than 12-v. models. Fills bike tires in seconds and HR78-15 car tire in only 2.3 min. Maintenance-free Teflon®-coated piston seal for long life. Delivers 1.0 SCFM at 30 PSI. Built-in pressure gauge. Incl. 8 ft. hose, universal air chuck, 3 inflation nozzles. UL listed. 6-ft. cord. Warranted by Sears, write for free copy, see p. 148. Not Craftsman.  
9 R 15025—Shpg. wt. 5 lbs. 8 oz. . . \$67.99

2 and 3 These Craftsman electric air compressors are perfect for any painting, cleaning, caulking or inflating job around your home. All include 15 ft. of ¼-in. diam. air hose and air chuck. UL listed. Warranted by Sears. Write for free copy, see p. 148.

2 ¾-HP compressor operates air brush sets, power washer, spray guns, drain cleaner and more! (See pgs. 46 and 47.) Has 100 PSI max. so you can even inflate racing bike tires. Adjustable pressure valve adjusts from 0 to 100 PSI. For oilless operation, unit has a hard-coated anodized aluminum cylinder with Teflon® ring and sealed bearings.

1-HP air compressor (not shown). Same as (2) except operates more air tools and accessories, and is more powerful so you can work faster than with (2).

Delivers		LxWxH	Catalog	Shpg.	Price
SCFM	PSI	inches	Number	wt.	
(2) ¾-HP model delivers 100 PSI max.					
2.7	40	15x9x11	9 R 15027C	27 lbs.	\$109.99
1-HP model (not shown) delivers 100 PSI max.					
5.0	40	15x19x11	9 R 15028C	28 lbs.	\$139.99
3.3	90				

3 For as little as \$10 MONTHLY (see p. 148), our Craftsman good-quality electric air compressor delivers 100 PSI max. . . giving you enough air power to unplug your drains, caulk, wash autos, siding . . . all on regular household current! For oilless operation, unit has a hard-coated anodized aluminum single-cylinder pump with Teflon ring and sealed bearings. 7.5-gallon air tank allows you to work faster than with units without tank, above. Protective shrouding covers heat-producing parts. Equipped with pressure regulator and 1½-in. diameter gauge. 6-in. diameter wheels and pull handle let you roll compressor anywhere around your home or yard. Compact enough to be easily portable . . . 26Lx14Wx22H in. Runs on standard 115-volt household current. 15 amps at maximum pressure. UL listed.

¾-HP unit (not shown) delivers 2.7 SCFM at 40 PSI, 2.0 SCFM at 90 PSI.  
9 R 15304C—Shpg. wt. 57 lbs. . . \$179.99

1-HP unit delivers 5.0 SCFM at 40 PSI, 3.3 SCFM at 90 PSI.  
9 R 15401C—Shpg. wt. 60 lbs. . . \$209.99

1-HP unit as above, plus meets requirements of ASME†.  
9 R 15411C—Shpg. wt. 64 lbs. . . \$219.99

## Our portable electric air compressors can show you why CRAFTSMAN® air compressors are America's Best Sellers!

From household to shop tasks, CRAFTSMAN air compressors teamed up with the right accessories make almost any job faster and easier. See our wide range of tools and accessories on pages 46 thru 50



4 thru 7 These compressors require oil for operation (order below). Before ordering your compressor, be sure to see our Air Compressor Facts Note and ASME† note below. All are warranted by Sears. Write for free copy, see p. 148.

4 Just \$23 MONTHLY (see p. 148). Sears Best CRAFTSMAN 5-HP electric air compressor with 30-gallon air tank delivers 12.0 SCFM at 40 PSI; 10.0 SCFM at 90 PSI . . . 125 PSI maximum. Meets requirements of ASME† 240-v. operation. Receptacle sold below. Req. 15-amp circuit breaker or slow blow fuse. Measures 41x21x33-in. UL listed.  
9 R 15665N—Shpg. wt. 155 lbs. . . \$679.99

5 thru 7 All units include the same exclusive compressor pump as (4), designed with a cast-aluminum head and deep fins for cooler operation. Cast-iron cylinder sleeves for durability, computer-designed crankshaft reduces noise and vibration. Easy-access air intake filter for quick replacement.

5 Just \$17 MONTHLY (see p. 148). Our finest 2-HP electric air compressor with 20-gal. air tank runs on standard household current! 7.8 SCFM at 40 PSI, 6.3 SCFM at 90 PSI, 100 PSI max. Cool-touch safety shroud has recessed tool tray for storing spray guns, fittings, etc. Control panel is equipped with air pressure regulator, 2-in. diameter, full-needle gauges to measure air line and tank holding pressure. 10-in. diam. wheels and ¾-in. diam. pull handle for portability. Incl. 15 ft. of ¾-in. diam. hose, air chuck. 120-v. convertible to 240-v. (order req. receptacle below). 20-amp circuit breaker or slow-blow fuse.  
38Lx19Wx30H in.  
9 R 15652N—Shpg. wt. 131 lbs. . . \$479.99

\$17 MONTHLY (see p. 148). 2-HP unit same as (5) above plus meets requirements of ASME†. Requires 15-amp circuit breaker or slow-blow fuse. UL listed. 39Lx13Wx30H in.  
9 R 15662N—Shpg. wt. 133 lbs. . . \$489.99  
220-240-volt receptacle (not shown) 240-v. units.  
9 R 5929—Shpg. wt. 3 oz. . . \$2.49

Extension cord (9-83572), for use with air compressors that run on standard household current, sold on page 103.

6 For as little as \$14 MONTHLY (see p. 148).

Craftsman better-quality electric air compressors provide enough power for many air tools. 2 and 3-HP models deliver 100 PSI max.; 5-HP models deliver 125 PSI max. 8-in. diam. wheels (10-in. on 9-17695N). ¾-in. diam. pull handles. Equipped with 1½-in. diam. gauge and pressure regulator (except 9 R 17685N has gauge and valve outlet only). Belt guard helps protect operator. Incl. 15 ft. of ¼-in. diam. air hose and air chuck. Requires 15-amp circuit breaker or slow-blow fuse. 2 and 3-HP units are 120-v. convertible to 240-v.; 5-HP units 240-v. (order receptacle below, left).

HP	SCFM at 40 PSI	SCFM at 90 PSI	Tank gal.	LxWxH inches	Catalog Number	Wt. lbs.	Price
2	7.8	6.3	12	34x17x27	9 R 17682N	106	\$349.99
2	7.8	6.3	12	35x17x27	9 R 17682N†	112	359.99
2	7.8	6.3	20	39x19x30	9 R 17612N	130	439.99
2	7.8	6.3	20	39x19x30	9 R 17622N	130	449.99
3	8.8	7.7	20	39x19x30	9 R 17673N	126	489.99
3	8.8	7.7	20	39x19x30	9 R 17683N†	130	499.99
5	11.3	9.3	20	39x19x30	9 R 17685N†	132	549.99
5	11.3	9.3	30	41x21x33	9 R 17695N†	154	599.99

7 \$20 MONTHLY (see p. 148). Craftsman gas-powered air compressor has heavy-duty, 5-HP 4-cycle gasoline engine. Delivers 12.0 SCFM at 40 PSI, 10.0 SCFM at 90 PSI . . . 110 max. PSI. Recoil start. Throttle control. Belt and pulley guard. 20-gallon tank. Large 3-qt. fuel tank. Equipped with tank pressure gauge and tank shut-off valve. Includes 15 ft. of ¼-in. diam. air hose and air chuck. 8-inch diameter wheels. Truck-mounting kit incl. Convertible to stationary operation. Meets ASME† requirements. 40x20x30 in. high.  
9 R 15715N—Shpg. wt. 148 lbs. . . \$599.99

8 Mounting brackets convert portable air compressors (4 and 5) into stationary units. Stainless steel.  
9 R 16425—Shpg. wt. 1 lb. . . \$2.99

9 Compressor oil for all Sears single-stage oil-lubricated compressors. 1-pt. bottle fills reservoir of portable compressors.  
9 R 16426—Shpg. wt. 1 lb. 12 oz. . . Btl. \$1.59

AIR COMPRESSOR FACTS NOTE: Air delivery is measured by Standard Cubic Feet per Minute (SCFM) at Pounds per Square Inch (PSI). SCFM: Air volume output. A higher SCFM allows more paint to be sprayed in a given time and increases the number of tools that can be operated by the compressor. PSI: Air pressure output of the compressor. Higher PSI allows a heavier body paint to be sprayed and more effective operation of many air tools. Extension cords can cause motor overheating and failure to start. Try our air hoses instead, page 44.

ASME: American Society of Mechanical Engineers  
NPT: National Pipe Tapered

†ASME NOTE: Customers for tank-type air compressors with 7½ gallon tanks in Los Angeles County, California; Massachusetts, New Jersey, Oregon and Puerto Rico must order units that meet requirements of ASME (American Society of Mechanical Engineers). In addition, customers for 20, 24 and 30 gallon tank size units in the above locations, plus the state of Arkansas, must order units that meet requirements of ASME.

SPRAY GUN TERMS NOTE: Bleeder-type guns are for use with compressors without regulated air pressure. Use non-bleeder guns with tank-type models regulated to maintain constant pressure. Pressure-feed guns for heavy paints and latex. Siphon-feed guns light-bodied enamels, lacquers, stains, varnishes. Internal mix delivers less overspray and needs less air volume than external mix; not recommended for fast-drying paints or high-quality finishes. Spray guns warranted by Sears. Write for free copy, see page 148. All our guns, except 9-15581, can be used with pressurized paint tank 9-16104.



Each is different, but together they're all you really need



To apply for SearsCharge only  
CALL TOLL FREE  
1-800-323-3274  
IN ILLINOIS CALL  
1-800-942-7446

Our finest CRAFTSMAN 5-HP electric air compressor includes lots of terrific features all designed with you in mind!

**\$679<sup>99</sup>**

This unit offers our exclusive Craftsman compressor pump with:

- ✓ Cast-aluminum head and deep fins for cooler operation
- ✓ Cast-iron cylinder sleeves for durability and long life
- ✓ Computer-designed crankshaft that reduces noise and vibration
- ✓ Easy-access air intake filter for fast and simple replacement

PLUS:

- ✓ Cool-touch safety shroud and easy-to-reach control panel with recessed tool tray
- ✓ Air pressure regulator and 2-in. diameter, easy-to-read full needle gauges
- ✓ Both pull and lift handles for easier lifting in and out of truck beds
- ✓ Can also be used as stationary outfit when you buy mounting brackets (8)
- ✓ Extra-stable, 10-in. diam. wheels provide easy portability
- ✓ Incl. 15-ft. of  $\frac{3}{8}$ -in. diam. air hose and air chuck

**Sears Best**



Our finest CRAFTSMAN® 2-HP electric Air Compressor has many of the same features listed above . . . PLUS it runs on STANDARD HOUSEHOLD CURRENT!

**\$479<sup>99</sup>** and up



CRAFTSMAN better-quality electric air compressors

**\$349<sup>99</sup>** and up



CRAFTSMAN heavy-duty gas-powered 5-HP air compressor works anywhere you do . . . incl. truck mounting kit and is convertible to stationary operation

**\$599<sup>99</sup>**



Mounting brackets for (4 and 5)

Compressor oil prolongs life of working parts without gummy build-up



# Stationary Air Compressors for light commercial and



## Single-stage Units

**CRAFTSMAN®**  
5-HP electric Air Compressors with 30-gallon air tanks **\$599<sup>99</sup>**

Sears  
5-HP electric  
Air Compressor  
with 60-gallon  
air tank  
**\$699<sup>99</sup>**

**1 thru 3** Available in Catalog only! Single-stage stationary electric air compressors are for use at home, in the body shop, service station or factory... wherever permanent installation is desirable. All feature our exclusive Craftsman pump, built of die-cast aluminum with cast-iron cylinder sleeves for long pump life. Forced air cooling system with aluminum fins for efficient cooling. Crankshaft needle bearings help reduce vibration and wear. Require oil for operation, sold at right. Meet requirements of ASME, UL listed. Warranted by Sears. Write for free copy, see p. 148. Before ordering, be sure to see our Air Compressor Facts Note on facing page.

- 1** \$20 monthly, (see p. 148). Delivers 12.0 SCFM at 40 PSI, 10.0 SCFM at 90 PSI, 125 PSI max. Automatic switch starts the 2-cylinder pump load-free. Relief and check valves. Fan-bladed flywheel. 3/8-in. female NPT air outlet. Single-phase pump; operates on 240-v. 60 Hz. AC. Req. 15-amp circuit breaker or slow-blow fuse (not incl.). Meas. 26x17x54 in. high. 9 R 17510N—Shpg. wt. 210 lbs... \$599.99
- 2** \$20 monthly, (see page 148). Unit with horizontal tank is same as above except measures 40x16x13-inches high. 9 R 15705N—Shpg. wt. 158 lbs... \$599.99

- 3** \$24 monthly, (see page 148). Unit delivers 11.3 SCFM at 40 PSI, 9.3 SCFM at 90 PSI, 125 PSI max. Equipped with pressure gauge and no-load start pressure switch. Belt guard helps protect operator. Single-phase pump; operates on 240-v. 60 Hz. AC. Req. 15-amp circuit breaker or slow-blow fuse (not incl.). Meas. 29x26x77-in. high. 9 R 17125N—Shpg. wt. 275 lbs... \$699.99
- Don't forget the oil! All compressors on this page require compressor oil for operation. 1 pint bottle. For use with single-stage compressors only. 9 R 16426—Shpg. wt. 1 lb. 12 oz... Btl. \$1.59



**8** Air and Paint Hoses

**11** Hose Repair Kit



**12** Air Pumps for special needs

Single-stage Air Pump for the home or small shop delivers up to 125 PSI†

Two-stage Air Pump for heavy-duty use delivers up to 175 PSI†



Protect air tools, accessories, and get professional quality results with these Filters, Regulators, and Lubricators

**8 thru 10** Extend your work range with the proper hose. The use of larger diam. hoses results in less pressure drop.

**8** Air hose is vinyl tubing with vinyl braided cover. 200 PSI† working pressure, 800 PSI bursting strength. 1/4-in. female swivel fittings.

Diameter	Length	Catalog Number	Shpg. wt.	Price
1/4-in.	25 ft.	9 R 16167	1 lb. 1 oz.	\$11.99
1/2-in.	25 ft.	9 R 16173	1 lb. 11 oz.	14.99
3/4-in.	25 ft.	9 R 16184	2 lbs. 1 oz.	17.99
1-in.	50 ft.	9 R 16177	3 lbs. 1 oz.	24.99

**9** Self-coiling nylon tubing air hose has 200 PSI† working pressure, 800 PSI bursting strength. Resists oil, grease and rot. 25-ft. long.

Diam.	Catalog No.	Shpg. wt.	Price
1/4-in. male swivel fittings			
1/4-in.	9 R 16221	10 oz.	\$13.99
1/4-in. male swivel fittings			
1/4-in.	9 R 16224	1 lb. 5 oz.	\$18.99

**10** Air and paint hose is rubber tubing with Neoprene cover. 250 PSI† working pressure, 1000 PSI bursting strength. 3/8-in. diam. hose has 3/8-in. female fittings. 25 feet long. For oil and latex paints only; not for use with lacquers. 9 R 16201—Shpg. wt. 3 lbs. 1 oz... \$23.99

**11** Hose repair kit for 1/4 to 3/4 in. diam. hoses. Incl. 1 female fitting, 1 splicer, 3 worm-drive clamps. 9 R 16302—Shpg. wt. 2 oz... \$2.79

**12 and 13** These air pumps deliver compressed air "on demand". Operate with special or compressor-duty motors (not incl.). Warranted\*.

Motor specs	Pulley diam.	SCFM† at	Catalog Number	Wt. lbs.	Price
HP	in.	40 PSI	90 PSI	125 PSI	175 PSI
(12) 2 3/4-in. diam. bore: 3450 rpm; 2-in. stroke.					
1	1.7	6.9	5.6	5.3	
2	2.3	9.3	7.7	6.7	9 R 17411C
					31 \$159.99
(13) 4 3/4 and 2 1/2-in. diam. bore: centrifugal unloader, 1725 rpm; 3-in. stroke.					
3	3.8	10.2	10.1	10.0	
5	6.4	17.3	17.2	17.0	9 R 17523N
					135 \$549.99

**14 thru 20** Threaded 3/8-in. inlet, outlet ports. 2 extra 1/4-in. reducing bushings for 1/4-in. hose fittings except (18, 19).

Catalog Number	Shpg. wt.		Price	Catalog Number	Shpg. wt.		Price
	lbs.	oz.			lbs.	oz.	
(14) Air filter, regulator and gauge prevents dirt and liquids from entering gun or tank. 5-150 PSI†. 175 PSI max. inlet pressure. 9 R 16023	2	9	\$34.99	(18) Pressure gauge for air, water and oil. Readings to 200 PSI†. 1/4-inch male thread. 9 R 16042	3		\$6.49
(15) Heavy-duty pressure regulator and Gauge. Max. input 300 PSI†, max. output 125 PSI. Regulates pressure from 5 to 125 PSI†. 9 R 16036	1	12	\$19.99	(19) Wall bracket for (14, 15, 16, 20). 9 R 16019	3		\$2.49
(16) Air line filter prevents dirt and liquids from entering gun or tank. For oil-base paints, lacquers. Max. inlet pressure 150 PSI†. 9 R 16009	1	9	\$15.99	(20) Oil fog lubricator helps prolong life of air tools. Helps prevent friction damage. Not for spray guns. Automatic flow sensing. 9 R 16017	1	8	\$20.99

†PSI: Pounds Per Square Inch  
SCFM: Standard Cubic Feet per Minute  
ASME: American Society of Mechanical Engineers  
NPT: National Pipe Tapered  
\*Warranted by Sears. Write for free copy, see p. 148.

industrial applications . . . Most available in Catalog only!



### Heavy-duty 2-stage Units

Deliver the higher sustained air pressure you need for your heaviest-duty jobs

CRAFTSMAN® 5-HP electric Air Compressor with 60-gallon air tank

**\$799<sup>99</sup>**

4



CRAFTSMAN® 5-HP electric Air Compressors with 80-gallon air tanks (5 and 6)

**\$1099<sup>99</sup>**

3-phase units

5



6



Sears 2-stage, 12-HP gas-powered Air Compressor with 30-gallon air tank

**\$1779<sup>99</sup>**

7

4 thru 6 2-stage electric air compressors are more efficient, run cooler and last longer than single-stage units. A large cylinder compresses intake air to approx. 40 PSI (first stage). Compressed air is then discharged through an intercooler to dissipate heat and into the smaller cylinder which compresses air to 150 PSI for 60-gal. unit, 175 PSI for 80-gal. units (second stage). Air then passes into storage tank. Require oil for operation . . . see owner's manual. All meet req. of ASME. Before ordering, see our Air Compressor Facts Note at right. Warranted by Sears. Write for free copy, see p. 148.

4 Only \$27 MONTHLY (see p. 148). Delivers 11.0 SCFM at 40 PSI. 10.8 SCFM at 90 PSI. 150 PSI maximum. 60-gal. vertical air tank. Aluminum pump to dissipate heat; cast iron cylinder sleeves for durability. Pressure gauge and no-load start pressure switch. Oil level sight glass. Wire belt guard designed for better ventilation. 28x20x69 in. high. 230-v. 60-Hz. AC. Requires 15-amp circuit breaker or slow-blow fuse (not included).  
9 R 17525N—Shpg. wt. 268 lbs. . . \$799.99

5 Available in Catalog only! \$37 or \$40 MONTHLY, (see page 148), compressors with 80-gallon vertical tanks can hold 1.5 times as much air at 175 PSI as 60-gallon tanks at 150 PSI. Deliver 15.5 SCFM at 175 PSI, for higher SCFM use lower PSI. Pump has die-cast aluminum head with deep fins for improved cooling; cast-iron cylinder sleeves for durability. Ball bearings on crankshaft. Rod bearing inserts. Belt and pulley guard help protect operator. Splash lubrication for positive flow of oil. Incl. pressure gauge, check valve, safety relief valve and shut-off valve with 3/4-in. NPT male connection. Both 1 and 3-phase models require magnetic starter\* (not incl.); run on 240-v., 60 Hz. 3-phase also convertible to 460-v. Pressure switch for pilot control of magnetic starter.  
Measure 29x24x67-in. high.  
T 9 R 17715N—1-phase. Wt. 415 lbs. . . \$1199.99  
T 9 R 17725N—3-phase. Wt. 415 lbs. . . \$1099.99

6 Available in Catalog only! \$37 or \$40 MONTHLY, (see p. 148), these compressors are the same as (5), except have horizontal tanks.  
Measure 64x21x41-in. high.  
T 9 R 17735N—1-phase. Wt. 410 lbs. . . \$1199.99  
T 9 R 17745N—3-phase. Wt. 410 lbs. . . \$1099.99

Items with a "T" prefix (such as T 9 R 17715N) could take extra time for delivery

\*Consult local contractor for wiring and electrical codes. 6000 watts at max. pressure, check with local power company before ordering.

7 Available in Catalog only! Only \$60 MONTHLY, buys this gas-powered 2-stage compressor that delivers up to 17.0 SCFM at 175 PSI, 180 PSI max. Has durable cast-iron pump and cylinders. Oversized taper roller bearings and stainless steel reed valves provide easy maintenance. Fits in most pick-up trucks with interior bed widths of 43-in. or more. 4-cycle engine has electric starter (req. 12-v. battery, not incl.). Cradle mounting reduces vibration. Air pressure gauge marked in 5-lb. increments to max. 300 lbs. 1/2-in. female NPT air outlet. Centrifugal unloader. Drain and service valves. Constant speed heat unloader. Intake filter silencer has removable elements. Multiple "V" belt drive has belt guard. Pneumatic throttle automatically slows engine during non-pumping cycle. 1 1/2-gal. fuel tank. 42x19x46-in. high. Meets req. of ASME. Warranted by Sears. Write for free copy, see p. 148. See Air Compressor Facts Note, below.  
T 9 R 17518N—Shpg. wt. 430 lbs. . . \$1779.99

AIR COMPRESSOR FACTS NOTE: Air delivery is measured by Standard Cubic Feet per Minute (SCFM) at Pounds per Square Inch (PSI). SCFM: Air volume output. A higher SCFM allows more paint to be sprayed in a given time and increases the number of tools that can be operated by the compressor. PSI: Air pressure output of the compressor. Higher PSI allows a heavier body paint to be sprayed and more effective operation of many air tools. Extension cords can cause motor overheating and failure to start. Try our air hoses instead, sold on facing page. ASME: American Society of Mechanical Engineers  
NPT: National Pipe Tapered

# Take a look at our accessory selection and discover just how versatile your air compressor can be!



Sandblaster with shoulder strap is so lightweight you can carry it with you... holds up to 30 lbs. of material without refilling! Hose and gun store neatly inside unit when not in use



Our largest capacity sandblast system is so efficient, it holds up to 120 lbs. of material without refilling!



Portable air tank provides reserve air storage for the really big jobs

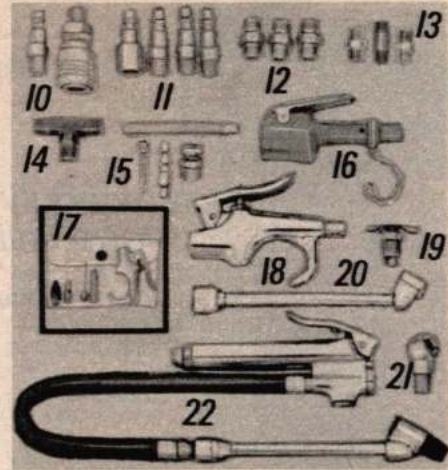

Mini-spray gun kit handles medium to heavy viscosity materials



Hobby air brush set has single-action control...



Professional air brush set with double-action fingertip control varies pattern width from 1/16 to 1 3/8-in. without stopping!



Power caulk gun applies caulk and sealants from std. 11 oz. tubes

CRAFTSMAN power washer can revolutionize the way you clean... also includes built-in, retractable foliage nozzle for garden-maintenance



Drain cleaner includes 4 inserts to fit almost any drain!

1 and 2 For paint, rust removal; etching, cleaning. Guns are nonbleeder, siphon feed. Req. min. 1-HP tank-mounted compressor.

1 Gun has 3/16-in. hardened steel nozzle. Includes 5-feet of 3/8-inch diameter material hose. 14x5x17 inches high.  
9 R 16806—Wt. 5 lbs. 1 oz. . . \$37.99

2 Gun has 3/8-in. ceramic nozzle. Sift screen. Unit has 8-in. wheels. 15-ft. of 3/8-in. diameter material hose. 13x11x26 in. high.  
9 R 16809C—Wt. 17 lbs. . . \$94.99

60-lb. cap. model like (2) but without wheels. 10Lx10Wx20H-in.  
9 R 16808—Wt. 8 lbs. . . \$74.99

Repl. ceramic nozzle for (1, 2) and 9-16808 above.  
9 R 16815—Wt. 1 oz. . . \$11.99

Repl. ceramic nozzle for 9-16802.  
9 R 16805—Wt. 2 oz. . . \$11.99

3 85 to 125 PSI working pressure. Brass air distribution valve, pressure gauge, 4-ft. of 3/8-in. diam. air hose, air chuck, handle. Not for sale in New Jersey or Puerto Rico.

9-gallon tank measures 21x13x15-in.  
9 R 16124C—Wt. 27 lbs. . . \$54.99

6-gallon tank measures 21x12x10-in.  
9 R 16126C—Wt. 24 lbs. . . \$39.99

4 For overall coverage. Pattern adjusts 1/2 to 2-in. External mix. 8-ft. vinyl hose, 4-oz. attached jar, 1/4-in. NPT\* adapter. Requires 15 to 50 PSI\*.  
9 R 15502—Wt. 11 oz. . . \$13.99

5 Pattern is adjustable from 1/16-in. to 1 1/4-in. Incl. 8-ft. vinyl hose, four 3/4-oz. jars, 1/4-in. NPT\* adapter. Internal mix, requires 15 to 50 PSI\*.  
9 R 15504—Wt. 1 lb. 2 oz. . . \$49.99

Propellant pack lets you use (4, 5) without compressor. Two 11-oz. cans. Not sold in OR.  
9 R 15509G—Wt. 2 lbs. 8 oz. . . Pkg. \$7.99

6 Adj. set screw. Internal mix. Fine detail tip, heavy viscosity tip, tip guard, 8-ft. hose. Has one 2-oz., two 3/4-oz. jars. 1/2 in. NPT\* adapter. Requires 15 to 50 PSI\*. Not for use with 9-15509.  
9 R 15506—Wt. 2 lbs. 4 oz. . . \$89.99

7 1/4 in. air hose connection. Requires 10 to 70 PSI\*. Bleeder/nonbleeder.  
9 R 16307—Wt. 1 lb. . . \$9.49

8 Cleans cars, siding, degreases engines. 10-ft. chemical draw hose. Works with min. 1/2-HP compressor with 2.2 SCFM\* at 40 PSI\*. Bleeder/nonbleeder. Warranted. Order concentrated cleaner below.

9 R 16225—Wt. 4 lbs. . . \$27.99

Concentrated detergent. 1 quart.  
9 R 16420—Wt. 2 lbs. 5 oz. . . \$2.79

Concentrated degreaser. 1 quart.  
9 R 16421—Wt. 2 lbs. 4 oz. . . \$2.79

\*See facing page.

9 Incl. 14-in. extension tube with toilet fitting. Splashback shield. Requires 40-125 PSI\*.  
9 R 16810—Wt. 3 lbs. . . \$27.99

Catalog Number	Shpg. wt.	Price
(10) 1/4-in. quick connector set is a must for the frequent user... makes tool, hose changes easy. Coupler with 1/4-in. NPT* male threads, 1/4-in. NPT male stud for tools, guns	4 oz.	\$4.49
9 R 16241—Pkg. of 2	4 oz.	\$4.49
1/4-inch quick connector set incl. 1/4-in. female coupler, 1/4-in. female stud, 1/4-in. NPT*xNPS* brass connector.	6 oz.	\$4.99
9 R 16245—Pkg. of 3	6 oz.	\$4.99
3/8-in. quick connector set incl. coupler with 3/8-in. NPT* female threads, one 1/4-in. NPT male stud for tools, one 3/8-in. NPT male stud for tools	6 oz.	\$5.49
9 R 16242—Pkg. of 3	6 oz.	\$5.49
(11) 1/4-in. stud set for quick connectors above. 3 NPT* male; 1 NPT female studs	4 oz.	\$3.49
9 R 16243—Pkg. of 4	4 oz.	\$3.49
(12) Double male connectors for hose. Brass. 1/4-in. NPS* for connecting air hose only.	2 oz.	\$2.29
9 R 16281—3 pc. set	2 oz.	\$2.29
3/8-in. male connectors like (12) for air or paint hose.	4 oz.	\$3.49
9 R 16241—3 pc. set	4 oz.	\$3.49
(13) 1/4-in. connector set incl. 1/4-in. NPT*xNPS* for hose to tool connections, 1/4-in. NPT for connecting accessories, 1/4-in.x1 1/2-in. long for connecting compressor manifold to filters and regulators	1 lb. 14 oz.	\$2.29
9 R 16290—Pkg. of 3	1 lb. 14 oz.	\$2.29
Set of 3/8-in. male connectors for hose to hose, hose to accessory, accessory to accessory connections. Brass. 3/8-in. for air only.	4 oz.	\$3.99
9 R 16289—Pkg. of 3	4 oz.	\$3.99
(14) Tee adapter allows use of 2 tools or guns at once. Brass. 1/4-in. NPT* male threads.	1 oz.	\$2.79
9 R 16217	1 oz.	\$2.79
(15) Inflator kit for all compressors incl. inflator needle for basketballs, footballs, etc.; inflating tube for toys, pools and air mattresses, air dusting tube, and tire inflator-adapter for bicycle and auto tires.	2 oz.	\$4.49
9 R 16276	2 oz.	\$4.49
(16) Heavy-duty blow gun meets requirements of OSHA. Max. inlet pressure 135 PSI*. 1/4-in. female thread. Lever action, round tip. Plastic.	3 oz.	\$3.79
9 R 16234	3 oz.	\$3.79
(17) Blow gun kit incl. blow gun (18) plus 4-pc. tip set for added versatility. Easy-store plastic pouch.	12 oz.	\$9.49
9 R 16237—Pkg. of 4	12 oz.	\$9.49
(18) Pro-type blow gun meets OSHA req. Outlet pressure drops to less than 30 PSI* when deadened. Max. inlet pressure 135 PSI*. 1/4-in. female thread. Lever action, round tip.	6 oz.	\$5.49
9 R 16235	6 oz.	\$5.49
(19) Tank drain valve. Brass. 1/4-in. fitting.	1 oz.	\$2.49
9 R 16253	1 oz.	\$2.49
(20) Dual tire air chuck for tires on trucks, campers and motor homes. 1/4-inch female thread.	4 oz.	\$4.99
9 R 16272	4 oz.	\$4.99
(21) Tire air chuck, 1/4-in. male thread.	2 oz.	\$2.29
9 R 16269	2 oz.	\$2.29
Tire air chuck, 1/4-in. female thread.	2 oz.	\$2.29
9 R 16271	2 oz.	\$2.29
(22) Long tire chuck and gauge reads 10-90 PSI*. 12-in. hose, 6-in. chuck. Turns 360°, 1/4-in. female thread.	1 lb. 2 oz.	\$22.99
9 R 16311	1 lb. 2 oz.	\$22.99
Replacement felt filter pads fit air intake head of 1978 to 1987 Craftsman, and all 1982 to 1987 Sears portable air compressors. Pkg. of 2	1 oz.	\$1.79
9 R 16279	1 oz.	\$1.79

We've got the right CRAFTSMAN® spray gun for any job from home workshop projects to industrial applications!



1  
Sears Best general-purpose spray gun takes on heavy-duty home projects  
\$57.99



2  
Medium-duty spray gun handles small tasks around the home  
\$37.99



3  
Our better medium-duty general-purpose spray gun is ideal for a wide range of homeowner jobs  
\$47.99



4  
Sears Best general-purpose spray gun takes on heavy-duty home projects  
\$57.99



5  
High-performance, production-type spray gun is designed for professional use  
\$77.99



6  
Detail/Touch-up Gun is perfect for close work  
\$99.99

### Industrial quality spray gun

Gives you the high performance you need for professional auto refinishing and industrial use  
\$139.99



All spray guns are warranted by Sears.† Before ordering, see our Spray Gun Terms Note below.

1 Spray gun is bleeder-type, pressure feed. Internal mix. Has 1-qt. plastic cup, screw-on release. Req. min. 8 SCFM\* at 10 PSI\*.  
9 R 15581—Shpg. wt. 1 lb. 8 oz. . . \$18.99

2 Gun handles all types of paints and finishing materials. Has fluid control knob. Bleeder/non-bleeder. Pressure/siphon feed. Internal/external mix. Has 1-qt. aluminum screw-on cup. Req. 1.5 SCFM\* at 40 PSI\*.  
9 R 15512—Shpg. wt. 2 lbs. . . \$37.99

3 Use this gun with all types of fast drying paints to complete home jobs from painting lawn furniture to car repair. Spray pattern adjusts from round to oval. Adj. fan and fluid controls. Non-bleeder. Pressure/siphon feed. External mix. Includes 1 qt. cup, spray cap and tip. Req. 2.7 SCFM\* at 40 PSI\*.  
9 R 15513—Shpg. wt. 2 lbs. 3 oz. . . \$47.99

4 Sears Best general-purpose gun even takes on auto painting! For use with all types of fast drying paints. Spray pattern adjusts from round to oval. Non-bleeder. Pressure/siphon feed. Internal/external mix. Incl. 1 qt. cup, two spray caps and tip. Req. 5.0 SCFM\* at 40 PSI\*.  
9 R 15514—Shpg. wt. 2 lbs. 3 oz. . . \$57.99

5 Designed for professional automotive and other types of refinishing. Use with fast drying thin and medium paints. Spray pattern adjusts from round to oval. Non-bleeder. Siphon feed. External mix. Incl. 1 qt. drip-free quick-release cup, spray cap and tip. Req. 8.3 SCFM\* at 40 PSI\*.  
9 R 15515—Shpg. wt. 2 lbs. 12 oz. . . \$77.99

6 This gun bridges the gap between a full-size gun and an airbrush. Adjusts from fan spray for flat, wide surfaces to round spray for small, irregular surfaces and close work. Non-bleeder, siphon feed, external mix. Requires minimum 2.5 SCFM\* at 30 PSI\*. 8 oz., cam-lock cup.  
9 R 15501—Shpg. wt. 1 lb. 4 oz. . . \$99.99

7 This spray gun boasts the largest spray pattern and highest material flow of any gun we sell! Forged aluminum gun body for superior strength. High-quality polished brass air cap, retaining ring and air inlet fitting. For use with acrylics, primers, lacquers, automotive metallics, other light and medium-viscosity finishes. Spray pattern adjusts from round to oval. High-speed delivery. Sensitive fan, fluid controls. Non-bleeder. Siphon feed. External mix. Incl. 1-qt. drip-free quick-release cup. Req. 9.6 SCFM\* at 40 PSI\*.  
9 R 15516—Shpg. wt. 3 lbs. 3 oz. . . \$139.99

8 Mask protects you against non-toxic paint particles, pollen and dust. Non-allergenic polyethylene.  
9 R 16351—Shpg. wt. 2 oz. . . \$4.29

Replacement filters for (8). Pkg. of 2  
9 R 16361—Shpg. wt. 1 oz. . . Pkg. \$1.99

9 Replacement gasket kits. Shpg. wt. 1 oz.  
9 R 15952—For ((2) and 9-15583) . . . Kit \$3.79  
9 R 15966—For (3 and 4) . . . Kit \$8.49  
9 R 15967—For (5) . . . Kit \$8.49  
9 R 15968—For (7) . . . Kit \$17.99

10 Nylon replacement strainers for all spray guns on page except 9-15581. Pkg. of 3.  
9 R 16383—Shpg. wt. 1 oz. . . Pkg. \$4.29

11 Cone strainers with gauze inserts strain paint before use. Pkg. of 6.  
9 R 16371—Shpg. wt. 2 oz. . . Pkg. \$1.79

12 Viscosimeter helps you determine correct paint thickness for a specific task. Plastic.  
9 R 16393—Shpg. wt. 10 oz. . . \$3.79

13 Paint tank holds up to 2½ gal. of paint or set 1 gal. can in bottom to cut refill time. Galvanized steel tank. Pressure regulator self-limiting to 60 PSI\*. Safety valve. Req. ¼-in. diam. air and ⅜-in. diam. paint hoses. 11Lx11Wx15H in. Not sold in NJ or Puerto Rico. Use with roller (14), or Sears spray guns, except 9-15581. Warranted by Sears, write for free copy, see page 148.  
9 R 16104C—Shpg. wt. 14 lbs. 8 oz. . . \$74.99

14 High-speed paint roller for use with paint tank (13) or other Sears paint tanks. Automatically feeds paint to roller head for quick distribution. Use indoors or out. The 18-in. extension pole reaches ceiling or trim with ease. Replacement roller covers available in our 1987/88 Tools Special, p. 71.  
9 R 16103—Shpg. wt. 3 lbs. . . \$69.99

SPRAY GUN TERMS NOTE: Bleeder-type guns are for use with compressors without regulated air pressure. Use non-bleeder guns with tank-type models regulated to maintain constant pressure. Pressure-feed guns for heavy paints and latex. Siphon-feed guns for light-bodied enamels, lacquers, stains, varnishes. Internal mix delivers less overspray and needs less air volume than external mix; not recommended for fast-drying paints or high-quality finishes. All our guns, except 9-15581, can be used with pressurized paint tank 9-16104.

\*PSI: Pounds Per Square Inch  
SCFM: Standard Cubic Feet per Minute  
NPT: National Pipe Tapered  
NPS: National Pipe Standard

†Warranted by Sears. Write for free copy, see p. 148.

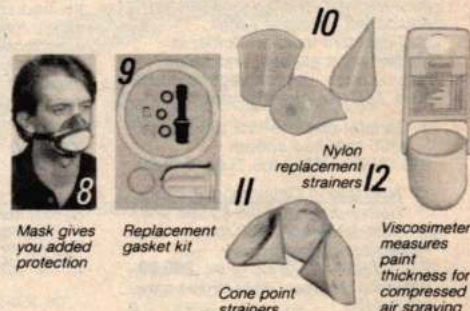

8 Mask gives you added protection

9 Replacement gasket kit

10 Nylon replacement strainers

11 Cone point strainers

12 Viscosimeter measures paint thickness for compressed air spraying



Use our 2½-gallon paint tank (13) with a spray gun, or with our indoor/outdoor high-speed power roller (14), to paint large areas faster than with conventional methods!



# Air Drive

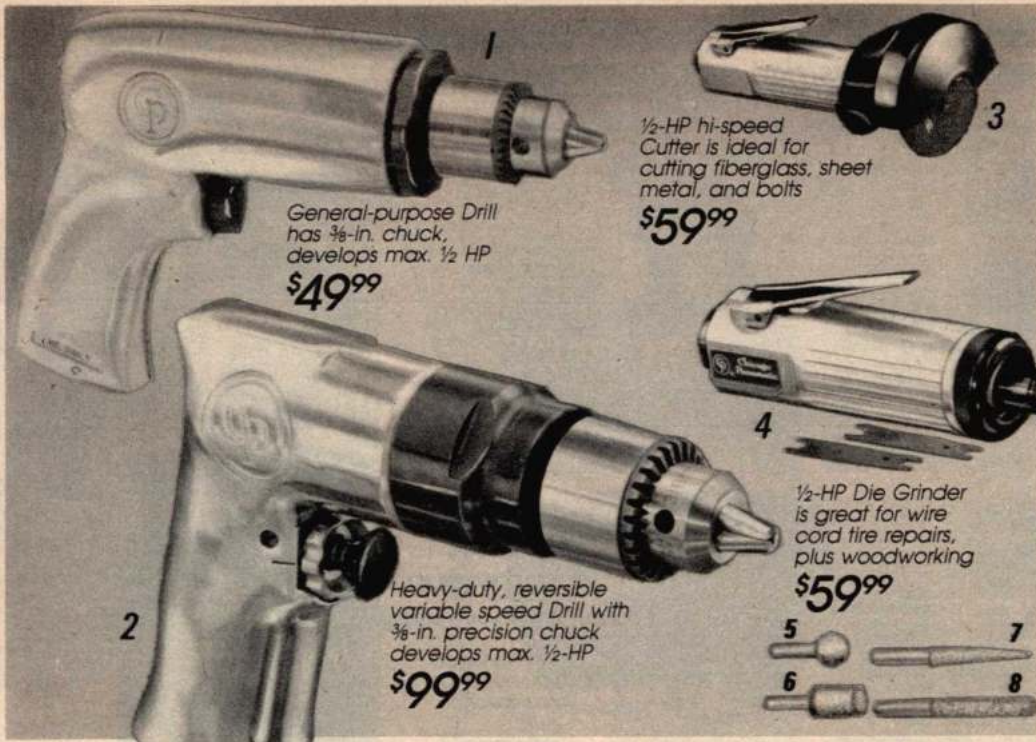

General-purpose Drill has  $\frac{3}{8}$ -in. chuck, develops max.  $\frac{1}{2}$  HP  
**\$49<sup>99</sup>**

$\frac{1}{2}$ -HP hi-speed Cutter is ideal for cutting fiberglass, sheet metal, and bolts  
**\$59<sup>99</sup>**

Heavy-duty, reversible variable speed Drill with  $\frac{3}{8}$ -in. precision chuck develops max.  $\frac{1}{2}$ -HP  
**\$99<sup>99</sup>**

$\frac{1}{2}$ -HP Die Grinder is great for wire cord tire repairs, plus woodworking  
**\$59<sup>99</sup>**



$\frac{3}{8}$ -in. sq. dr. Ratchet delivers 10-50 ft. lbs. torque  
**\$54<sup>99</sup>**

$\frac{1}{4}$  in. sq. dr. Ratchet measures just  $6\frac{1}{2}$  in. long, delivers 5-15 ft. lbs. torque  
**\$49<sup>99</sup>**

Before ordering any air drive tool, see our air power requirements chart and air compressor facts note at right.

1 and 2 Great for the body shop . . . or making adjustments and repairs to lawn and garden tractors, other power equipment. Designed with stall-resistant motors. Muffler in handle vents exhaust and helps reduce noise.  $\frac{3}{8}$ -inch Jacobs chuck.  $\frac{1}{4}$ -in. NPT air inlet. Warranted†.

1 General-purpose drill develops 1800 rpm free speed.  
9 R 18896—Wt. 3 lbs. 3 oz. **\$49.99**

2 Available in Catalog only! Heavy-duty variable-speed drill has free speed of 2200 rpm. Reversible. Imported.  
9 R 18898—Wt. 2 lbs. 9 oz. **\$99.99**  
†Warranted by Sears. Write for free copy see p. 148.

3 Available in Catalog only! Has a no-load speed of 20,000 rpm. Order cut-off wheel below. Imported. Warranted†.  
9 R 18891—Wt. 2 lbs. . . **\$59.99**  
Cut-off wheel for (3). 3-in. diam.  
9 R 18839—Wt. 3 oz. . . **\$8.99**

4 Available in Catalog only! \$10 less than in our 1986/87 Tools Specialog.  $\frac{1}{2}$ -HP die grinder has a no-load speed of 22,000 rpm. For safety reasons, be sure to use accessories rated at least 22,000 rpm. Includes 2 chuck wrenches. Imported.  $\frac{1}{4}$ -inch NPT. Warranted†. Tool Bk. price \$69.99.  
9 R 18887—Wt. 1 lb. 14 oz. **\$59.99**

5 thru 8 Burrs for die grinder (4). Rated 40,000 rpm.

Item	Catalog No.	Wt.	Price
(5) Small round ball . . . . .	9 R 30089	2 oz.	<b>\$6.99</b>
(6) $\frac{1}{2}$ -inch barrel . . . . .	9 R 30088	1 oz.	<b>6.99</b>
(7) $\frac{1}{4}$ -inch pointed pencil . . . . .	9 R 30087	1 oz.	<b>3.99</b>
(8) $\frac{1}{8}$ -inch pencil . . . . .	9 R 30086	1 oz.	<b>3.99</b>

9 A must for every mechanic, this  $\frac{3}{8}$ -in. ratchet can loosen or tighten bolts where hand or other power tools just cannot reach. Delivers 10-50 ft. lbs. torque, 150 rpm. Finger-controlled teasing throttle. Reversible.  $\frac{1}{4}$ -inch NPT air inlet. Imported. Warranted†.  
9 R 18803—Wt. 3 lbs. . . **\$54.99**

10 Available in Catalog only! Delivers 5-15 ft. lbs. torque, 200 rpm max. Finger-controlled teasing throttle. Reversible.  $\frac{1}{4}$ -in. NPT air inlet. Imported. Warranted†.  
9 R 18804—Wt. 1 lb. 3 oz. **\$49.99**

Air tool lubricating oil (not shown) helps keep your equipment in top shape for the longest service life possible. We recommend lubricating before and after each use to clean and remove gum . . . just pour into air inlet and let work thru tool. 16-oz. can.  
9 R 18810—Wt. 1 lb. 2 oz. Can **\$3.29**

**AIR COMPRESSOR FACTS NOTE:**  
Air delivery is measured by standard cubic feet per minute (SCFM) at pounds per square inch (PSI). SCFM: Air volume output. A higher SCFM allows more paint to be sprayed in a given time and increases the number of tools that can be operated by the compressor. PSI: Air pressure output of the compressor. Higher PSI allows a heavier body paint to be sprayed and more effective operation of many air tools.  
ASME: American Society of Mechanical Engineers  
NPT: National Pipe Tapered

**AIR POWER REQUIREMENTS CHART**  
(for items on pages 48 and 49)

Item	SCFM	PSI	Hose diam.	Tank gal.
(10)	2.5	90	$\frac{3}{8}$ -in.	12
(27)	3.0	90	$\frac{3}{8}$ -in.	12
(26)	3.5	90	$\frac{3}{8}$ -in.	12
(1), (2), (15)	4.0	90	$\frac{3}{8}$ -in.	12
(16), (25), (28)	4.0	90	$\frac{3}{8}$ -in.	12
(9)	4.0	90	$\frac{3}{8}$ -in.	12
(11)	6.0	90	$\frac{3}{8}$ -in.	20
(12), (13)	8.0	90	$\frac{3}{8}$ -in.	20
(14)	8.0	90	$\frac{3}{8}$ -in.	20
(29)	7.5	90	$\frac{3}{8}$ -in.	20
(3)	10.0	90	$\frac{3}{8}$ -in.	30
(4)	10.0	90	$\frac{3}{8}$ -in.	30
(30)	12.0	90	$\frac{1}{2}$ -in.	60

11 Available in Catalog only! Incl 3, 4, 5-in. fiber disc sanding pads.  $\frac{1}{2}$ -HP motor develops no-load speed of 20,000 rpm. Imported. Warranted†.  
9 R 18969—Shpg. wt. 2 lbs. 10 oz. . . **\$39.99**

12 For a fine finish on furniture, auto body repairs on flat surfaces. 8,000 rpm free speed. Order 3 $\frac{1}{2}$ x9-in. sanding paper sold on page 79. Rear exhaust. Imported. Warranted†.  
9 R 18828—Shpg. wt. 7 lbs. 4 oz. . . **\$59.99**

13 Has rotary action for smooth, circular sanding and orbital action for a patternless finish. 10,000 rpm free speed. 6-in. neoprene sanding disc, rubber guards. Imported. Warranted†.  
9 R 18979—Shpg. wt. 7 lbs. 3 oz. . . **\$59.99**

Sanding discs for (13). Paper-backed aluminum-oxide 6-in. diam. No center hole; use disc cement, sold on p. 78. Pkg. of 6.

Grit	Catalog Number	Shpg. wt.	Pkg.
Extra-fine . . . . .	9 R 25257	1 oz.	<b>\$1.89</b>
Fine . . . . .	9 R 25258	3 oz.	<b>1.89</b>
Medium-fine . . . . .	9 R 25259	2 oz.	<b>1.89</b>

14 Works at 3,000 one-inch strokes per minute. Order 2 $\frac{3}{4}$ x17 $\frac{1}{2}$ -in. paper below. Bottom exhaust. Warranted†.  
9 R 18976—Shpg. wt. 7 lbs. 4 oz. . . **\$79.99**

Sandpaper for (14). Paper backed, aluminum-oxide.

Grit	Catalog Number	Shpg. wt.	Pkg. of 6
Medium . . . . .	9 R 30056	3 oz.	<b>\$1.89</b>
Coarse . . . . .	9 R 30057	5 oz.	<b>1.89</b>



Hi-speed rotary action Sander . . . perfect for auto body repairs  
**\$39<sup>99</sup>**



Rotary/orbital-action Sander for final finishing of auto-body repairs  
**\$59<sup>99</sup>**



**\$59<sup>99</sup>**  
12

Orbital-action Sander gives you a fine, swirl-free finish, even in hard-to-reach spots



14  
**\$79<sup>99</sup>**

Dual-piston straight line Sander is ideal for body-filler shaping on flat surfaces

# Tools for home or shop use



15  
Short-barrel Impact Hammer delivers up to 3500 blows per minute  
**\$39<sup>99</sup>**

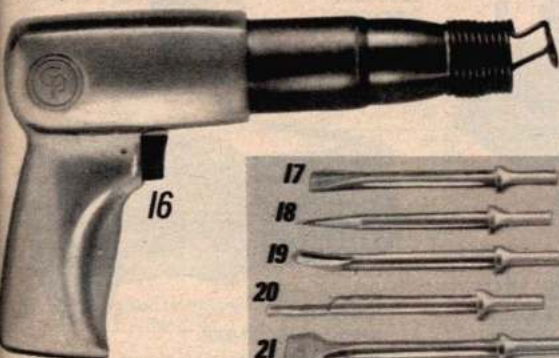

16  
Long-barrel Impact Hammer delivers up to 2100 blows per minute  
**\$49<sup>99</sup>**

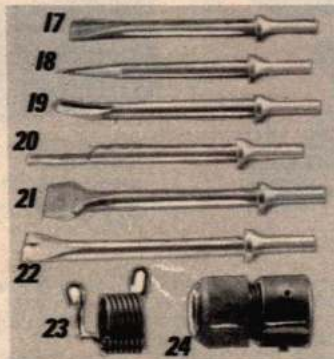

Before ordering any air drive tool, remember to check our air power requirements chart and air compressor facts note on facing page.

15 Short-barrel impact hammer. Incl. retainer attachment (23). Warranted by Sears. Write for free copy, see p. 148.  
9 R 18894—Wt. 4 lbs. 1 oz. **\$39.99**

16 Available in Catalog only! Long-barrel impact hammer is the hardest hitting hammer we sell! Includes retainer attachment (23). Warranted by Sears. Write for free copy, see p. 148.  
9 R 18915—Wt. 4 lbs. 14 oz. **\$49.99**

17 thru 24 For (15 and 16). 401 openings.

Item	Catalog No.	Wt.	Price
(17) Rivet cutter.....	9 R 18823	6 oz.	\$4.49
(18) Tapered punch.....	9 R 18824	5 oz.	4.49
(19) Muffler splitter....	9 R 18820	6 oz.	6.49
(20) Pipe/panel cutter....	9 R 18821	5 oz.	6.49
(21) 1 1/2-in. flat chisel..	9 R 18822	6 oz.	4.49
(22) Claw ripper.....	9 R 18825	5 oz.	6.49
(23) Retainer attach....	9 R 18831	3 oz.	2.49
(24) Post-lock retainer..	9 R 18830	12 oz.	18.99

25 thru 30 Whether removing tire lug nuts, shocks, exhaust systems, or anything else involving threaded fasteners, our CRAFTSMAN® impact wrenches can help finish the job quickly and easily... they work equally well for tightening and loosening. Warranted by Sears. Write for free copy, see p. 148.

Items with a "T" prefix (such as T 9 R 18959) could take extra time for delivery



26  
Our best-selling 1/2-in. sq. dr. Impact Wrench delivers 25-280 ft. lbs. torque, 375 max.  
**\$69<sup>99</sup>**



25  
1/2-in. sq. dr. Impact Wrench delivers 20-250 ft. lbs. torque, 325 max.  
**\$59<sup>99</sup>**



27  
1/2-in. sq. dr. Impact Wrench delivers 25-320 ft. lbs. torque, 420 max.  
**\$89<sup>99</sup>**



28  
3/8-in. sq. dr. Impact Wrench is ideal for one-handed work  
**\$69<sup>99</sup>**



29  
Heavy-duty, 3/8-in. sq. dr. reversible Impact Wrench delivers 100-500 ft. lbs. torque, 700 max.  
**\$229<sup>99</sup>**



30  
Heavy-duty, 1-in. sq. dr. Impact Wrench delivers 150-900 ft. lbs. torque 1400 max.  
**\$359<sup>99</sup>**

## (31 thru 39) Air Drive Accessories

31 2-ft., 3/8-in. diam. air hose has 1/4-in. male fittings on both ends.  
9 R 18956—Wt. 8 oz. . . . **\$8.49**

32 16-pc., 1/4-in. sq. dr. impact set incl. eight 6-pt. sockets (7/16 thru 1/2-in.); snap ring adapter socket; 4 screwdrivers (2 slotted, 2 Phillips); 2 ext. bars (3, 6-in.), 3/8-in. spark plug socket†\*.  
9 R 18936—Wt. 1 lb. . . . Set **\$8.99**

33 12-pc. 1/2-in. sq. dr. impact socket set incl. 11 sockets (7/16 thru 1 1/16); metal clip rail. 6-pt. openings†\*. Wt. 3 lbs. 6 oz.  
9 R 18938 . . . Set **\$34.99**  
9-pc. 3/8-in. sq. dr. impact socket set incl. 8 sockets (1/4 thru 1 1/16-in.); metal clip rail. 6-pt. openings†\*.  
9 R 18939—Wt. 15 oz. . . . **\$17.99**

34 thru 39 Craftsman air drive accessories of heat-treated, oil quenched and tempered alloy steel. Impact accessories have black oxide finish.

34 Screwdriver chuck and bits incl. 1/2-in. sq. dr. no. 2 Phillips, nos. 12-14, 14-16 slotted bits with finders†. Shpg. wt. 1 lb. 3 oz.  
9 R 18867 . . . Set **\$42.99**

35 Impact chuck converts 1/2-in. sq. dr. wrench to drill. Use bits 1/8 to 1/2-in. diam. For wood or metal†. 9 R 18953—Wt. 1 lb. 2 oz. . . . **\$24.99**

36 1/2-in. sq. dr. impact extension bar measures 6 in. long†. 9 R 18960—Wt. 10 oz. . . . **\$6.49**  
†Warranted by Sears. Write for free copy, see p. 148.  
\*Imported

37 1/2-in. sq. dr. double-end socket. 6-pt. openings; 3/4-in. at one end, 1 3/16-in. at other. For 1/2-in. sq. dr. impact tools with extended shank\*. 9 R 18958—Wt. 7 oz. . . . **\$4.49**

38 Impact universal joints\* 9 R 18955—3/8-in. Wt. 2 oz. **\$7.49**  
9 R 18957—1/2-in. Wt. 6 oz. **\$8.49**

39 Impact socket adapter. 1/2-in. sq. drive converts to 3/8-in.\* 9 R 18961—Wt. 3 oz. . . . **\$5.49**

14-pc. socket set. Incl. items (33, 36, and 9-18957). Wt. 4 lbs. 11 oz.  
9 R 18940 . . . Set **\$44.99**

6-pc. chisel set incl. chisels (17 thru 22). Sep. prices total \$32.94.  
9 R 18826—Wt. 1 lb. 5 oz. Set **\$26.99**



# Choose CRAFTSMAN® air drive tools for terrific results on the toughest jobs!



**1**  
1/2-in. square drive impact wrench delivers 25-225 ft. lbs. of working torque  
**\$54<sup>99</sup>**



**2**  
1/2-in. square drive impact wrench delivers 25-400 ft. lbs. of working torque  
**\$94<sup>99</sup>**



**3**  
3/8-in. square drive ratchet wrench delivers 10-45 ft. lbs. of working torque  
**\$49<sup>99</sup>**

**4**  
Short-barrel impact hammer gives you 3700 hammer-action blows per min.  
**\$34<sup>99</sup>**



**5**  
General purpose drill develops 2200 rpm free speed  
**\$54<sup>99</sup>**



**6**  
Hi-speed cutter has no-load speed of 18,000 rpm  
**\$49<sup>99</sup>**

Use air power to make sanding a breeze!

Orbital-action sander

**\$54<sup>99</sup>**



**7**  
Hi-speed rotary-action sander  
**\$34<sup>99</sup>**



**8**  
Rotary/orbital-action sander  
**\$54<sup>99</sup>**



**9**  
Straight-line sander  
**\$89<sup>99</sup>**



**1 thru 10** Warranted by Sears.† (1 thru 6) have 1/4-in. NPT\* air inlet; use 3/8-in. diam. hose.

**1** Impact wrench has plastic scuff guard and built-in regulator. Reversible. Ring-type socket retainer. Req. min. 4.0 SCFM\* at 90 PSI\*, 12-gal. tank. Imported. 9 R 18884—Shipping weight 6 lbs. . . \$54.99

**2** New at Sears! 1/2-in. impact wrench for heavy equipment maintenance and auto repairs. Supported ring socket retainer. Built-in power regulator. Balanced for best power to weight ratio. Req. 4.0 SCFM\* at 90 PSI\*, min. 20-gal. tank. 9 R 18899—Shipping weight 6 lbs. . . \$94.99

**3** 3/8-in. ratchet wrench delivers 10-45 ft. lbs. of torque, no-load speed of 150 rpm. 4.0 SCFM\* at 90 PSI.\* Reversible ball-type socket retainer. Finger-controlled throttle. Req. 12-gal. tank. Imported. 9 R 18802—Shipping weight 1 lb. 15 oz. . . \$49.99

**4** Short barrel air hammer removes brake drums, universal joints, exhaust systems and more! Req. 4.0 SCFM\* at 90 PSI\*, minimum 12-gal. air tank. 9 R 18897—Shipping weight 2 lbs. 12 oz. . . \$34.99

**5** Use at home or in the shop. 3/8-in. air drill has muffler in handle that reduces noise and vents exhaust. Requires 4.0 SCFM\* at 90 PSI\*, 12-gallon tank. 9 R 18895—Shipping weight 2 lbs. 5 oz. . . \$54.99

**6** For cutting fiber glass, sheet metal and bolts choose this high speed cutter. Req. min. 4.0 SCFM\* at 90 PSI\*, 30-gal. tank. Imported. 9 R 18880—Shipping weight 1 lb. 14 oz. . . \$49.99

Heavy-duty hose reel has 25-ft., 3/8-in. diam. rubber hose, 3/8-in. male fittings. Up to 200 PSI\*. 9 R 18999—Shipping weight 22 lbs. . . \$139.99

**7** Incl. 3, 4 1/2, 5 1/2-in. fiber disc sanding pads. 1/2-HP motor. No-load speed of 20,000 rpm. Req. min. 8.0 SCFM\* at 90 PSI\*, 3/8-in. diam. hose, 20-gal. tank. Imported. 9 R 18965—Shipping weight 2 lbs. 4 oz. . . \$34.99

**8** Has built-in regulator. 10,000 rpm free speed. 6-in. sanding disc flexes at edges. Circular exhaust. Req. min. 8.0 SCFM\* at 90 PSI\*, 3/8-in. diam. hose, 20-gal. tank. Imported. 9 R 18978—Shipping weight 5 lbs. . . \$54.99

**9** Has built-in regulator. Develops 8,000 rpm free speed. Muffled rear exhaust. 1/4-in. NPT\* air inlet. Req. min. 8.0 SCFM\* at 90 PSI\*, 3/8-in. air hose, 20-gal. tank. Imported. 9 R 18827—Shipping weight 4 lbs. 14 oz. . . \$54.99

**10** Delivers 2,100 1-inch strokes per min. Bottom exhaust. Req. min. 8.0 SCFM\* at 90 PSI\*, 3/8-in. diam. air hose, 20-gal. tank. Imported. 9 R 18970—Shipping weight 5 lbs. 14 oz. . . \$89.99



**11**  
Random orbital buffer/polisher with 9-inch pad delivers a hand-polished look



**12**  
Large 10 3/4-in. diameter buffer/polisher achieves a high-gloss finish

## Look to CRAFTSMAN for that "new car" shine

**11** Random orbital buffer/polisher has a direct-drive motor with no gears to wear out. 9-inch pad is chemically treated for longer life. Unit includes bonnets, 2-ounce cleaner/wax, 2-ounce cleaner/glaze, 6-foot 2-wire cord. Warranted.† Shpg. wt. 8 lbs. 9 R 10699 . . . \$67.99

9-inch cloth bonnets for (11). Package of 2. Shpg. wt. 4 oz. 9 R 10603 . . . \$5.99

**12** Buffer/polisher has large 10 3/4-inch diameter pad, chemically treated for longer life. Heavy-duty permanent magnetic motor has hardened steel shaft. Heavy-duty ball bearings and brushes. Includes 2 bonnets, 8-ounce cleaner/glaze, 9-ounce cleaner/wax. Stub-length 3-wire cord. Warranted.† Shipping weight 12 lbs. 6 oz. 9 R 1099 . . . \$109.99

8-ounce cloth bonnets for (12). Package of 2. Shpg. wt. 4 oz. 9 R 10997 . . . Pkg. \$4.49

11-oz. heavy-duty bonnets for (12). Package of 2. Shpg. wt. 4 oz. 9 R 10999 . . . Package \$7.49

Cleaner/glaze, 8 ounces. Not Craftsman. Shpg. wt. 8 oz. 9 R 10996 . . . Btl. \$2.49

Cleaner/wax, 9 ounces. Not Craftsman. Shipping weight 12 ounces. 9 R 10998 . . . Can \$4.49

9-in. waxing bonnet Shipping weight 2 ounces. 9 R 10601 . . . \$4.49

9-in. buffing bonnet Shipping weight 2 ounces. 9 R 10602 . . . \$4.49

\* National Pipe Tapered Pounds per Square Inch Standard Cubic Feet per Minute † Warranted by Sears. Write for free copy, see pg. 148.



Disc sander boasts . . .

- ✓ Powerful motor that develops max. 1 3/4-HP
- ✓ No-load speed of 4600 rpm
- ✓ Handle that fits either side of tool for convenient use, even in hard-to-reach spots

## CRAFTSMAN® body repair tools

1 thru 3 Available in Catalog only! Steel body bumping files. Wt. ea. 1 lb. 2 oz.

Type	Catalog Number	Price
(1) Flat coarse . . . . .	9 R 31201	\$8.99
(2) Flat medium . . . . .	9 R 31202	8.99
(3) Half-round medium . . . . .	9 R 31203	9.99

Available in Catalog only! Save 10% when you buy 3-pc. set of body bumping files incl. (1 thru 3). Separate prices total \$27.97.  
9 R 31204—Shpg. wt. 3 lbs. 8 oz. . . \$24.99

4 5-in. tungsten point ignition file.  
9 R 31205—Shpg. wt. 1 oz. . . \$1.49

5 thru 9 Available in Catalog only! Hammers are drop-forged steel with 12-in. long hickory handles.

Type	Catalog Number	Shpg. wt.	Price
5 1/2-in. head, 1 1/2-in. sq., 1 1/4-in. round face. (5) Bumping hammer . . . . .	9 R 4551	1 lb. 5 oz.	\$10.99
3 1/2-in. head, 3/4-in. sq., 1 1/4-in. round face. (6) Light bumping hammer . . . . .	9 R 4550	14 oz.	\$10.99
5 1/2-in. head, 1 1/2-in. round face; 2 1/2-in. pick. (7) Blunt pick hammer . . . . .	9 R 4553	1 lb. 1 oz.	\$10.99
5 1/2-in. head, 1 1/2-in. round face; 2 1/2-in. pick. (8) Pointed pick hammer . . . . .	9 R 4556	1 lb. 1 oz.	\$10.99
5 1/2-in. head; 1 1/2-in. round face; 2 1/2 x 3/4-in. cross-peen. (9) Cross-peen hammer . . . . .	9 R 4552	1 lb.	\$10.99

10 Drop-forged steel dolly has 8 molding, beading surfaces. Bottom for panel, fender skirt work.  
9 R 45651—Shpg. wt. 2 lbs. 14 oz. . . \$13.99

11 thru 13 Drop-forged steel dollys.

Type	Catalog Number	Shpg. wt.	Price
(11) Comb. dolly/spoon . . . . .	9 R 45631	3 lbs. 6 oz.	\$13.99
(12) Heel . . . . .	9 R 45621	2 lbs. 7 oz.	13.99
(13) Universal . . . . .	9 R 45611	3 lbs. 1 oz.	13.99

Save \$10.92 when you buy 9-pc. body fender set. Includes (5, 8, and 13). Separate prices total \$35.97.  
9 R 45884C—Shpg. wt. 18 lbs. . . Set \$99.99

Save \$5.98 when you buy this 3-pc. repair kit. Includes items (5, 8, and 13). Separate prices total \$35.97.  
9 R 45271—Shpg. wt. 6 lbs. 1 oz. . . Set \$29.99

14 thru 17 Craftsman shaping tools have chisel-like teeth in steel blades. Die-cast alloy bodies.

Measures	Catalog Number	Shpg. wt.	Price
(14) Standard plane 1 1/2 x 1 1/4-in. long . . . . .	9 R 67742	15 oz.	\$8.99
(15) Pocket plane 1 1/2 x 5/8-in. long . . . . .	9 R 67745	7 oz.	\$4.99
(16) Round file with hardwood handle, 5/8-in. diam., 1 1/4-in. long overall . . . . .	9 R 67743	5 oz.	\$6.99
(17) Hand shaping tool is 7 1/2-in. long . . . . .	9 R 67744	3 oz.	\$4.49

Extra blade for (14). Flat 1 1/2-in. wide.  
9 R 67747—Shpg. wt. 2 oz. . . \$2.69

Extra blade for (15).  
9 R 67746—Shpg. wt. 2 oz. . . \$2.29

CRAFTSMAN® disc sanders and grinders pack the power to handle automotive body and shop work . . . plus the finesse for household polishing and the speed to finish wood fast!

6-in., 3/8-HP disc sander/polisher  
**\$47.99**



5-pc. elliptical-motion polishing kit fits (19)

4 1/2-in., 3/4-HP disc grinder  
**\$47.99**



All our disc sanders and grinders are warranted by Sears. Write for free copy, see page 148.

18 Sander has permanently-lubed ball and roller bearings. 5/8-in. x 11 spindle. Includes 3 1/2-in. rubber back-up pad and 7-in. fiber pad.  
9 R 11501—Shpg. wt. 12 lbs. . . \$97.99

9-in. sanding kit for (18 and 9-11502, p. 97). Includes rubber back-up pad, lock nut.  
9 R 11159—Shpg. wt. 1 lb. . . Kit \$12.99

19 Sander/polisher is the right tool for light-duty sanding or household polishing. Max. 3/8 HP; 2 no-load speeds; 1650 rpm. for sanding, 1400 rpm for polishing. Permanently lubed ball, sleeve bearings. 1/2-in. x 20 spindle. Handle fits either side of tool. Incl. 6-in. backing pad, polishing bonnet, spanner nut, wrench.  
9 R 1052—Wt. 6 lbs. 8 oz. . . \$47.99

A Elliptical-motion polishing kit includes spindle adapter, polishing head, 2 wax applicator/removal and 1 polishing bonnet.  
Shpg. wt. 2 lbs. 8 oz.  
9 R 10528 . . . Kit \$19.99

21 Use 9-inch steel safety guard on (9-11502), 7-inch high-impact polymer safety guard on (9-11501) when using grinding wheel.

7-inch diam. safety guard.  
Shpg. wt. 8 oz.  
9 R 1711 . . . Each \$10.99

9-inch diam. safety guard.  
Shpg. wt. 1 lb. 11 oz.  
9 R 1712 . . . Each \$14.99

22 Light to med. duty nylon brush fits 5/8-in. spindle. 4-in. diam.  
9 R 64175—Wt. 8 oz. . . Ea. \$15.99

23 3-in. diam. light-duty wire cup brush. .012 wire fits 5/8-in. spindle.  
Shpg. wt. 6 oz.  
9 R 64133 . . . Each \$10.99

20 Available in Catalog only! Our disc grinder converts to sander with kit, discs sold below. Max. 3/4 HP with single no-load speed of 12,000 rpm. Permanently lubed ball, roller bearings. Handle fits either side. M10 x 1.5 spindle. 4 1/2-in. grinding wheel, guard. Imported.  
9 R 11500—Shpg. wt. 6 lbs. . . \$47.99

4 1/2-inch sanding kit for (20) incl. rubber back-up pad, lock nut.  
9 R 11149—Shpg. wt. 10 oz. . . Kit \$9.49

Package of ten 4 1/2-inch sanding discs.  
Fine grit.  
9 R 25284—Shpg. wt. 5 oz. . . Pkg. \$5.49

Medium grit.  
9 R 25285—Shpg. wt. 7 oz. . . Pkg. \$5.49

Coarse grit.  
9 R 25286—Shpg. wt. 8 oz. . . Pkg. \$5.49

4 1/2-inch, 30-grit alum.-oxide grinding wheel for (20).  
9 R 64104—Shpg. wt. 5 oz. . . Ea. \$4.99

4 1/2-inch, 24-grit silicon carbide wheels for (20). Pkg. of 2.  
9 R 64105—Shpg. wt. 9 oz. . . Pkg. \$8.79

3-in. heavy-duty twist steel wire brush for (20), fits 5/8-inch spindle.  
9 R 64125—Shpg. wt. 12 oz. . . \$10.99

Items (24 thru 26) fit 5/8-in. spindle.

24 5-in. diam. med.-duty wire cup brush. Wt. 2 lbs. 12 oz.  
9 R 64106 . . . Each \$12.99

25 Heavy-duty twist steel wire brush.  
9 R 64107—Wt. 10 oz. . . \$12.49

26 Aluminum-oxide grinding wheels.  
7-in. diam. Shpg. wt. 1 lb. 6 oz.  
9 R 64101 . . . Each \$7.49

9-inch diam. Shpg. wt. 2 lbs.  
9 R 64102 . . . Each \$8.79

Lamb's wool polishing bonnets.

Diam. in.	Cat. No.	Wt. oz.	Price
5 1/2 . . . . .	9 R 2521	3	Pkg. \$2.29
6-in. . . . .	9 R 2527	4	Pkg. 2.99
7-in. . . . .	9 R 2528	5	Pkg. 3.49



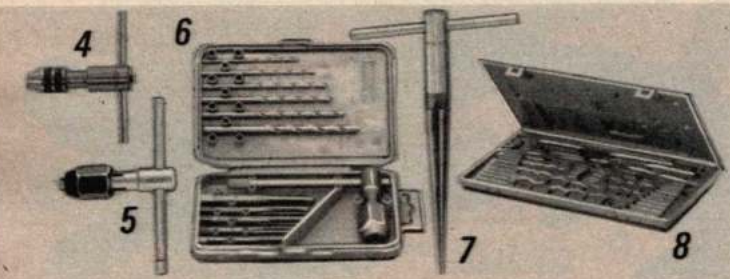
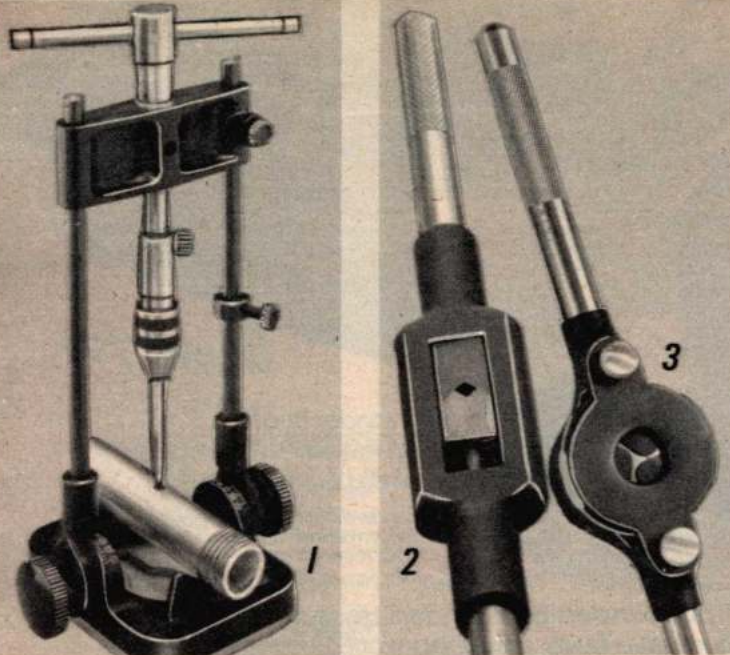

## CRAFTSMAN Threading Tools

1 Available at Sears in catalog only. Tap alignment tool sets the precise angle for threading from 45° to 90°. Scale marked in 5° increments. Aluminum "V" base holds round stock. Steel guide rods, adjustable depth control. Inc. ¼ and ⅜-in. cap. chucks. Taps not included.  
9 R 52116—Wt. 3 lbs. ... \$49.99

Available at Sears in catalog only. Conversion kit (not shown) turns tap alignment tool above into drill guide. Incl. cross slide with spindle, bearings and ⅜-in. cap. drill chuck.  
9 R 52115—Wt. 1 lb. 3 oz. ... \$19.99

2 thru 7 Warranted by Sears, write for free copy, see p. 148.

2 Tap and reamer wrenches have alloy steel jaws for strength.

Size No.	Tap capacity	Catalog Number	Wt. lbs. oz.	Price
4	⅜-½-in. 3 to 12mm	9 R 52551	8	\$8.49
6	¼-¾-in. 6 to 18mm	9 R 52552	1 8	12.99
7	¼-1½-in. 7 to 28mm ⅜, ½, ¾ in. pipe taps	9 R 52553	3 2	21.99

3 Alloy steel die stocks. 9-52554, 9-52555 are available at Sears in catalog only.

Die type and size	Catalog Number	Shpg. wt. lbs. oz.	Price
1-in. round, 1-in. hex	9 R 52556	9	\$7.99
1½-in. round, 1½-in. hex w/adj. guide	9 R 52554	1 14	13.99
1½-in. hex	9 R 52555	3 2	21.99

4 Available at Sears in catalog only. Adjustable "T" handle ratchet tap wrench with hardened self-centering replaceable jaws.

Capacity	Catalog No.	Wt.		Price
		lbs.	oz.	
0-¼-in. 0-6.3mm	9 R 4065	10		\$14.49
⅜-½-in. 6-12.5mm	9 R 4064	1		19.99

5 Steel "T"-handle tap wrenches. Fits up to #12 machine screw, ¼-in. and 3 to 6mm taps.  
9 R 52557—Shpg. wt. 3 oz. ... \$2.29

Available at Sears in catalog only. Fits ⅜ to ½-in., #4 to #14 machine screw and 3 to 6mm taps.  
9 R 4066—Shpg. wt. 7 oz. ... \$5.99

Fits #12 to ⅜-in., 5 to 8mm taps.  
9 R 52558—Shpg. wt. 5 oz. ... \$3.49

Fits ¼ to ½-in., 6 to 12mm taps, reamer with ¼ to ⅜-in. square shank, ½-in. ratchet.  
9 R 52559—Shpg. wt. 8 oz. ... \$5.49

Fits ¼ to ½-in., 6 to 12mm taps.  
9 R 4067—Shpg. wt. 13 oz. ... \$7.99

Available at Sears in catalog only. Thread gauges (not shown).

Type	Catalog No.	Wt.	Price
Standard	9 R 52229	1 oz.	\$4.19
Metric	9 R 52029	1 oz.	4.19

6 Tap and drill set incl. 6 machine screw taps (4-40, 6-32, 8-32, 10-32, 10-24, ¼-20), drill sizes 43, 36, 29, 25, 21, 7; tap wrench; case.  
9 R 52068—Wt. 8 oz. ... Set \$11.99

7 Available at Sears in catalog only. Heat-treated steel reamer for ⅜ to ½-in. holes. 5¼-in. long.  
9 R 5479—Shpg. wt. 1 oz. ... \$7.49

8 Available at Sears in catalog only. Permanex® plastic case for tap and die sets shown on page 53.

Fits Set	Catalog Number	Shpg. wt. lbs. oz.	Price
59-pc.	9 R 5218	3 5	\$12.99
41-pc.	9 R 5219	1 4	7.99

## CRAFTSMAN® Individual STANDARD and METRIC Taps and Dies

- ✓ Rust-resistant satin finish cuts more smoothly with less friction
- ✓ Meet American Metal Cutting Institute standards for "cut thread" tolerance
- ✓ Produce Class II fit as specified by the National Bureau of Standards

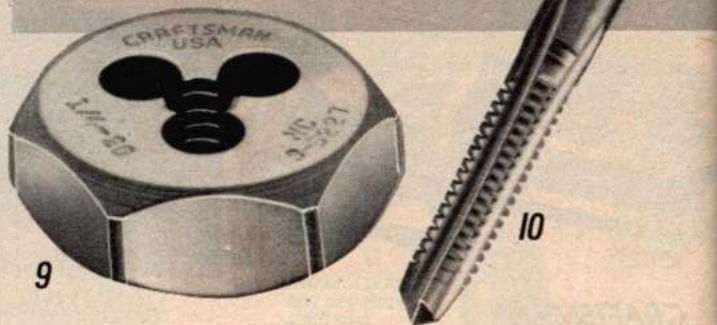

Craftsman individual taps and dies have the same construction as the carbon steel sets sold on facing page. Warranted by Sears, write for free copy, see p. 148.

Thread size	Die diam.	(9) STANDARD Hex Dies			(10) STANDARD Taps		
		Catalog Number	Wt.	Price	Catalog Number	Wt.	Price
National Coarse (USS) Threads							
¼-20	1 in.	9 R 52761	1 oz.	\$2.29	9 R 52736	1 oz.	\$1.29
⅜-18	1 in.	9 R 52765	1 oz.	2.29	9 R 52738	1 oz.	1.79
⅜-16	1 in.	9 R 52762	1 oz.	2.29	9 R 52737	1 oz.	2.19
7/16-14	1 in.	T 9 R 52763	1 oz.	2.29	T 9 R 52739	1 oz.	2.49
½-13	1 in.	T 9 R 52764	1 oz.	2.29	T 9 R 52741	2 oz.	2.99
½-13	1 ½ in.	T 9 R 52752	2 oz.	5.29			
9/16-12	1 ½ in.	T 9 R 52753	2 oz.	5.29	T 9 R 52742	2 oz.	4.29
¾-11	1 ½ in.	T 9 R 52754	2 oz.	5.29	T 9 R 52743	2 oz.	4.99
¾-10	1 ½ in.	T 9 R 52755	2 oz.	5.29	T 9 R 52744	4 oz.	5.99
¾-9	1 ½ in.	T 9 R 52783	6 oz.	8.99	T 9 R 52747	7 oz.	9.99
1-8	1 ½ in.	T 9 R 52784	5 oz.	8.99	T 9 R 52748	10 oz.	9.99
National Fine (SAE) Threads							
¼-28	1 in.	9 R 52766	1 oz.	\$2.29	9 R 52727	1 oz.	\$1.49
⅜-24	1 in.	9 R 52771	1 oz.	2.29	T 9 R 52728	1 oz.	1.79
⅜-24	1 in.	9 R 52767	1 oz.	2.29	9 R 52729	1 oz.	2.19
7/16-20	1 in.	T 9 R 52768	1 oz.	2.29	T 9 R 52731	1 oz.	2.49
½-20	1 in.	T 9 R 52769	1 oz.	2.29	T 9 R 52732	1 oz.	2.99
½-20	1 ½ in.	T 9 R 52756	2 oz.	5.29			
9/16-18	1 ½ in.	T 9 R 52757	2 oz.	5.29	T 9 R 52733	2 oz.	3.99
9/16-18	1 ½ in.	T 9 R 52758	2 oz.	5.29	T 9 R 52734	2 oz.	4.99
¾-16	1 ½ in.	T 9 R 52759	2 oz.	5.29	T 9 R 52735	4 oz.	6.49
¾-14	1 ½ in.	T 9 R 52781	6 oz.	8.99	T 9 R 52745	7 oz.	9.99
1-12	1 ½ in.	T 9 R 52782	5 oz.	8.99	T 9 R 52746	10 oz.	9.99
1-14	1 ½ in.	T 9 R 52785	5 oz.	8.99	T 9 R 52749	10 oz.	9.99
Machine Screw Taps and Dies—all National Coarse (except 10-32 is National Fine)							
4-40	1 in.	T 9 R 52772	1 oz.	\$2.29	9 R 52721	1 oz.	\$1.39
6-32	1 in.	T 9 R 52777	1 oz.	2.29	9 R 52722	1 oz.	1.39
8-32	1 in.	T 9 R 52773	1 oz.	2.29	9 R 52723	1 oz.	1.39
10-24	1 in.	T 9 R 52774	1 oz.	2.29	9 R 52724	1 oz.	1.39
10-32	1 in.	T 9 R 52775	1 oz.	2.29	9 R 52725	1 oz.	1.39
12-24	1 in.	T 9 R 52776	1 oz.	2.29	T 9 R 52726	1 oz.	1.39

T 9 R 52778—¼-inch hex Pipe Die. NPT thread. Shpg. wt. 1 oz. ... \$2.29  
 T 9 R 52751—¼-inch hex Pipe Die. NPT thread. Shpg. wt. 2 oz. ... \$5.29  
 T 9 R 52791—½-in. Pipe Tap. Shipping weight 1 oz. ... \$1.99  
 T 9 R 52792—¼-in. Pipe Tap. Shipping weight 1 oz. ... \$2.99

METRIC Hex Dies					METRIC Taps				
Die Diam.	(mm)	Catalog No.	Wt.	Ea.	(mm)	Catalog No.	Wt.	Ea.	
1 in.	3x.50	T 9 R 52871	1 oz.	\$2.49	3x.50	T 9 R 52961	1 oz.	\$1.99	
1 in.	3x.60	T 9 R 52872	1 oz.	2.49	3x.60	T 9 R 52962	1 oz.	1.99	
1 in.	3.5x.60	T 9 R 52893	1 oz.	2.49	3.5x.60	T 9 R 52981	1 oz.	1.99	
1 in.	4x.70	T 9 R 52873	1 oz.	2.29	4x.70	T 9 R 52963	1 oz.	1.99	
1 in.	4x.75	T 9 R 52874	1 oz.	2.29	4x.75	T 9 R 52964	1 oz.	1.99	
1 in.	4.5x.75	T 9 R 52894	1 oz.	2.49	4.5x.75	T 9 R 52982	1 oz.	1.99	
1 in.	5x.80	T 9 R 52875	1 oz.	2.29	5x.80	T 9 R 52965	1 oz.	1.99	
1 in.	5x.90	T 9 R 52876	1 oz.	2.29	5x.90	T 9 R 52966	1 oz.	1.99	
1 in.	6x1.00	T 9 R 52877	1 oz.	2.29	6x1.00	T 9 R 52967	1 oz.	1.99	
1 in.	6.3x1.00	T 9 R 52891	1 oz.	2.29	6.3x1.00	T 9 R 52979	1 oz.	2.49	
1 in.	7x1.00	T 9 R 52878	1 oz.	2.29	7x1.00	T 9 R 52968	1 oz.	2.19	
1 in.	8x1.00	T 9 R 52895	1 oz.	2.49	8x1.00	T 9 R 52983	1 oz.	2.29	
1 in.	8x1.25	T 9 R 52879	1 oz.	2.29	8x1.25	T 9 R 52969	1 oz.	2.29	
1 in.	9x1.00	T 9 R 52881	1 oz.	2.29	9x1.00	T 9 R 52971	1 oz.	2.49	
1 in.	9x1.25	T 9 R 52882	1 oz.	2.29	9x1.25	T 9 R 52972	1 oz.	2.49	
1 in.	10x1.00	T 9 R 52892	1 oz.	2.49	10x1.00	T 9 R 52987	1 oz.	3.49	
1 in.	10x1.25	T 9 R 52883	1 oz.	2.29	10x1.25	T 9 R 52973	1 oz.	3.29	
1 in.	10x1.50	T 9 R 52884	1 oz.	2.29	10x1.50	T 9 R 52974	1 oz.	3.29	
1 in.	11x1.50	T 9 R 52885	1 oz.	2.49	11x1.50	T 9 R 52975	1 oz.	3.49	
1 in.	¼x28T†	T 9 R 52888	1 oz.	2.49	¼x28T†	T 9 R 52978	1 oz.	3.29	
1 in.	12x1.50	T 9 R 52886	1 oz.	2.49	12x1.50	T 9 R 52976	1 oz.	3.49	
1 in.	12x1.75	T 9 R 52887	1 oz.	2.49	12x1.75	T 9 R 52977	1 oz.	3.49	
1 ½ in.	12x1.50	T 9 R 52991	2 oz.	5.99	14x1.25	T 9 R 52984	2 oz.	4.49	
1 ½ in.	12x1.75	T 9 R 52992	2 oz.	5.99	14x2.00	T 9 R 52985	2 oz.	4.49	
1 ½ in.	14x1.25	T 9 R 52993	2 oz.	5.99	16x1.50	T 9 R 52986	3 oz.	4.99	
1 ½ in.	14x2.00	T 9 R 52994	2 oz.	5.99	16x2.00	T 9 R 52987	3 oz.	4.99	
1 ½ in.	16x1.50	T 9 R 52995	2 oz.	5.99	18x1.50	T 9 R 52988	4 oz.	5.99	
1 ½ in.	16x2.00	T 9 R 52996	2 oz.	5.99	18x2.50	T 9 R 52989	4 oz.	5.99	
1 ½ in.	18x1.50	T 9 R 52997	2 oz.	5.99	¼x19T†	T 9 R 52896	2 oz.	3.99	
1 ½ in.	18x2.50	T 9 R 52998	2 oz.	5.99					
1 ½ in.	¼x19T†	T 9 R 52999	2 oz.	5.99					

†British Standard thread pipe tap ††British Standard thread pipe die  
 Items with "T" prefix may take extra time for delivery

SHOP BY PHONE  
 To order, call your local Sears store

# CRAFTSMAN Tap and Die Sets pass the test . . . meet the needs of repair shops, professional machinists and homeowners

- ✓ Manufactured to American Metal Cutting Institute standards
- ✓ Produces a Class II cut thread fit as specified by the National Bureau of Standards

## Homeowner's Sets

- ✓ Carbon steel taps and dies include the most widely used sizes
- ✓ Non-reflective matte finish makes size identification easy
- ✓ Hardened and tempered for smooth cutting action

See chart below. Warranted by Sears, write for free copy, p. 148.

12-pc. set incl. five 1/8-in. hex dies, 5 taps. Shpg. wt. 9 oz.  
9 R 52069 . . . \$11.99

20-pc. set incl. 4 machine screw taps. Shpg. wt. 1 lb. 8 oz.  
9 R 52341 . . . \$13.99

25-pc. set. Shpg. wt. 3 lbs. 10 oz.  
9 R 52342 . . . \$18.99

37-pc. set. Wt. set 3 lbs. 10 oz.  
STANDARD  
9 R 52343 . . . Set \$27.99

METRIC  
T 9 R 52344 . . . \$34.99

## Carbon steel Sets

- ✓ Hardened, precision ground and polished surfaces facilitate chip removal
- ✓ Rust-resistant satin finish
- ✓ Hex-shaped dies permit use of sockets and wrenches as well as die stocks

66-pc. STANDARD and all METRIC sets are Available at Sears in Catalog only. 29-pc. Metric Set has taps only, dies not incl. Warranted by Sears, see p. 148.

Pcs.	Catalog Number	Wt.		Sep. prices	Price set
		lbs.	oz.		
<b>STANDARD SETS</b>					
26	9 R 52351	4	3	\$83.03	\$49.99
41	9 R 52352	4	4	107.40	69.99
59	9 R 52353	13	..	221.45	159.99
66	T 9 R 52354C	21	..	333.04	199.99
<b>METRIC SETS</b>					
29	T 9 R 52371	3	..	\$93.11	\$69.99
41	T 9 R 52372	5	..	118.01	69.99
46	T 9 R 52374	6	2	163.13	99.99
59	T 9 R 52373	13	..	238.16	149.99

Items with a "T" prefix may take extra time for delivery

## Professional-quality Sets

- ✓ High-speed steel wears better, remains sharper longer than carbon steel
- ✓ Black-oxide coating reduces friction for smooth cutting action
- ✓ May be used with machine tools as well as manually

Available at Sears in Catalog only, our finest 59-pc. STANDARD or METRIC tap and die sets are ideal for the professional. Each set has a wide assortment of taps and dies in the most needed sizes plus quality Craftsman threading tools neatly packaged in a plastic case. Individual components listed in chart below. Warranted by Sears, write for free copy, see p. 148.

STANDARD set. Wt. 13 lbs. 12 oz.  
T 9 R 52311 . . . Set \$249.99

METRIC set. Wt. 13 lbs. 12 oz.  
T 9 R 52001 . . . Set \$259.99

## STANDARD Tap and Die Sets

Set size	Homeowner's Sets				Carbon Steel Sets				Professional Set
	12-pc.	20-pc.	25-pc.	37-pc.	28-pc.	41-pc.	59-pc.	66-pc.	59-pc.
Tap and die sizes*									
1/4-20NC	X	X	X	X	X	X	X	X	X
5/16-18NC		X	X	X	X	X	X	X	X
1/2-16NC		X	X	X	X	X	X	X	X
5/8-14NC			X	X	X	X	X	X	X
3/4-13NC			X	X	X	X	X	X	X
7/8-12NC						X	X	X	X
1-11NC						X	X	X	X
1 1/8-10NC							X	X	X
1 1/4-9NC								X	X
1-8NC								X	X
1/4-28NF		X	X	X	X	X	X	X	X
5/16-24NF		X	X	X	X	X	X	X	X
3/8-24NF		X	X	X	X	X	X	X	X
1/2-20NF		X	X	X	X	X	X	X	X
5/8-18NF		X	X	X	X	X	X	X	X
3/4-18NF						X	X	X	X
1-16NF						X	X	X	X
1 1/8-14NF							X	X	X
1-14NF								X	X
4-40				X		X	X		
6-32		X	X#		X	X	X	X	X
8-32		X	X#		X	X	X	X	X
10-24		X	X#		X	X	X	X	X
10-32		X	X#		X	X	X	X	X
12-24				X		X	X	X	X
1/8-27NPT			X	X	X	X	X	X	X
1/8-18NPT						X	X	X	X
Accessories									
Die Stock		X	X	X	X	2	3		2
T-handle Tap Wrench	X	X			X	2	X	X	X
Tap Driver		X	X	X					
Tap, reamer wrench				X	X	2	3		2
Thread gauge				X	X	X	X		X
Screw extractor						5			5
Screwdriver				X	X	X	X		X
Plastic case	X	X	X	X	X	X	X	X	X

\*NC-National Coarse (USS) thread  
NF-National Fine thread NPT-National Pipe Tapered  
4-40, 6-32, etc.-Machine screw thread #Tap only

## METRIC Tap and Die Sets

Thread Size (mm)	Homeowner's		Carbon Steel			Professional
	37-pc.	29-pc.	41-pc.	48-pc.	59-pc.	59-pc.
3x.50	X	X#	X			
3x.60	X	X#	X	X	X	X
3.5x.60			X#	X		
4x.70	X	X#	X	X	X	X
4x.75	X	X#	X	X	X	X
4.5x.75				X		
5x.80	X	X#	X	X	X	X
5x.90	X	X#	X	X	X	X
6x1.00	X	X#	X	X	X	X
6.3x1.00	X	X#	X			
7x1.00	X	X#	X	X	X	X
8x1.00			X#	X		
8x1.25	X	X#	X	X	X	X
9x1.00			X#	X	X	X
9x1.25	X	X#	X	X	X	X
10x1.00			X#	X		
10x1.25	X	X#	X	X	X	X
10x1.50	X	X#	X	X	X	X
11x1.50	X	X#	X	X	X	X
12x1.50	X	X#	X	X	X	X
12x1.75	X	X#	X	X	X	X
14x1.25			X#	X	X	X
14x2.00			X#	X	X	X
16x1.50			X#	X	X	X
16x2.00			X#	X	X	X
18x1.50			X#	X	X	X
18x2.50			X#	X	X	X
<b>BSP Pipe thread</b>						
1/2x28	X	X#	X	X	X	X
1/2x19			X#	X	X	X
Accessories						
Die Stock	X		X	2		2
T-handle Tap wrench				2	X	X
Tap Driver	X					
Tap, Reamer wrench				X	2	2
Thread Gauge			X	X	X	X
Screw extractor				5	5	
Screwdriver			X	X	X	X
Plastic Case	X	X	X	X	X	X

Save 20%  
when you buy any  
2 or more select  
CRAFTSMAN Files

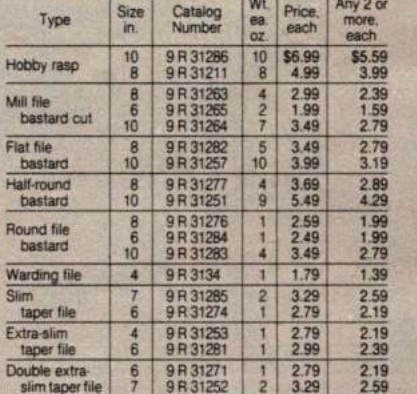
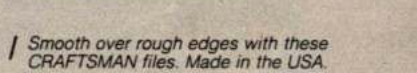
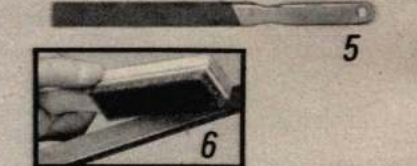
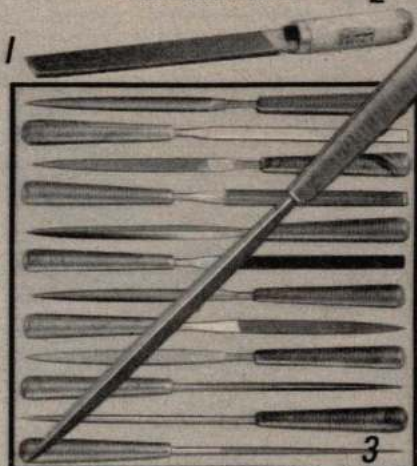

Smooth over rough edges with these CRAFTSMAN files. Made in the USA.

Type	Size in.	Catalog Number	Wt. ea. oz.	Price, each	Any 2 or more, each
Hobby rasp	10	9 R 31286	10	\$6.99	\$5.59
	8	9 R 31211	8	4.99	3.99
Mill file bastard cut	8	9 R 31263	4	2.99	2.39
	6	9 R 31265	2	1.99	1.59
	10	9 R 31264	7	3.49	2.79
Flat file bastard	8	9 R 31282	5	3.49	2.79
	10	9 R 31257	10	3.99	3.19
Half-round bastard	8	9 R 31277	4	3.69	2.89
	10	9 R 31251	9	5.49	4.29
Round file bastard	8	9 R 31276	1	2.59	1.99
	6	9 R 31284	1	2.49	1.99
	10	9 R 31283	4	3.49	2.79
Warding file	4	9 R 3134	1	1.79	1.39
Slim taper file	7	9 R 31285	2	3.29	2.59
	6	9 R 31274	1	2.79	2.19
Extra-slim taper file	4	9 R 31253	1	2.79	2.19
	6	9 R 31281	1	2.99	2.39
Double extra-slim taper file	6	9 R 31271	1	2.79	2.19
	7	9 R 31252	2	3.29	2.59

2 CRAFTSMAN adjustable file and tool handle fits tools with tangs up to 1/4-in. diameter.  
9 R 6775—Shpg. wt. 4 oz. . . \$3.49

3 Available at Sears only in Catalog. Swiss-pattern needle file set for all intricate filing applications. 5 1/2 in. long with No. 2 cut. Set of 12 files includes: round, half-round, square, three square, flat, knife, equaling, crossing, barrette, sitting, marking and joint, round edge files, pouch. Imported.  
9 R 6758—Shpg. wt. 4 oz. . . Set \$63.99

4 CRAFTSMAN 6-pc. needle file set with Swiss pattern. Single cut. 5 1/2-in. long.  
9 R 6757—Shpg. wt. 2 oz. . . Set \$11.99

5 CRAFTSMAN 7-in. rotary mower, garden tool file.  
9 R 31279—Shpg. wt. 3 oz. . . \$3.49

6 8 1/4-in. file cleaning brush of rigid wire.  
9 R 6782—Shpg. wt. 2 oz. . . \$4.49

OUR ANNUAL CATALOG HAS MORE

## New at Sears! This CRAFTSMAN® Portable Welder outfit is perfect for homeowners

- ✓ Comes complete with MAPP® and oxygen cylinders, so it's ready to use right away
- ✓ Compact, disposable cylinders are easy to replace, support up to 1 hour brazing time
- ✓ Sturdy blow-molded plastic case makes it simple to bring your torch to the jobsite, then store it later
- ✓ Includes project book with instructions on making your own welded furniture



**\$179<sup>99</sup>**

**\$10 MONTHLY**, see p. 148. Outfit is ready to use as soon as you get it home. Provides 3 metal working functions: cutting, welding and brazing. Unique oxygen hold-down latch simplifies cutting process. Both regulators have easy-to-read cylinder content and delivery pressure gauges. Includes No. 1 cutting tip and 3 welding/brazing tips for steel up to 3/16-in. thick. Outfit also includes 12-ft. hose, disposable cylinders, project book and instructions. Order accessories at right. Warranted by Sears. Write for free copy, see page 148

- 9 R 20271C—Shpg. wt. 17 lbs. . . \$179.99
- Similar to above, but without carry case or pressure gauges.
- 9 R 20270—Shpg. wt. 10 lbs. 7 oz. . . \$129.99
- Oxygen regulator for 9 R 20270 above.
- 9 R 20276—Shpg. wt. 1 lb. 7 oz. . . \$39.99
- MAPP regulator for 9 R 20270 above.
- 9 R 20277—Shpg. wt. 1 lb. 8 oz. . . \$39.99

- Welding tips.**
- 9 R 20287—No. 1. Wt. 5 oz. . . \$5.99
- 9 R 20288—No. 2. Wt. 5 oz. . . \$5.99
- 9 R 20289—No. 3. Wt. 5 oz. . . \$5.99
- Cutting head.**
- 9 R 20283—Wt. 7 oz. . . \$24.99
- Cutting tips.**
- 9 R 20284—No. 1. Wt. 5 oz. . . \$6.99
- 9 R 20285—No. 2. Wt. 5 oz. . . \$6.99
- 9 R 20286—No. 3. Wt. 5 oz. . . \$6.99
- 20-ft. extension hose with adapters.**
- 9 R 20290—Shpg. wt. 3 lbs. . . \$23.99
- Replacement case.**
- 9 R 20291—Shpg. wt. 3 lbs. 8 oz. . . \$12.99
- Replacement torch handle.**
- 9 R 20292—Shpg. wt. 13 oz. . . \$39.99
- Replacement oxygen cylinder.**
- 9 R 20294—Shpg. wt. 4 lbs. 15 oz. . . \$17.99

## CRAFTSMAN® Arc



**20-70-amp AC hobby welder \$89<sup>99</sup>**

Homeowners will appreciate our hobby welder that handles light sheet metal. Includes carbon arc torch for conventional welding, brazing or soldering. Use electrodes up to 3/32-inch diameter. Not recommended for use with low-hydrogen or stainless steel electrodes. Includes electrodes, 6-ft. work cables and electrode holder. 1/16—3/32-inch rod. Rated 20 input amps, 38-v. maximum open circuit secondary. Approximately 11x11x11 in. See note on p. 55.

9 R 20155C—Shpg. wt. 40 lbs. . . \$89.99



**TIG conversion kit available in catalog only**

As low as \$12 MONTHLY, (see p. 148). TIG\*\* conversion kit for alloy metals, aluminum, magnesium and stainless steel to 1/4-inch thick. Outstanding control with excellent visibility and pinpoint arc concentration. Includes torch, 1/16-inch electrode, regulator, 1/16, 3/32, 1/8-inch diameter collets. Electrodes sold on page 57. 8-foot, 3-wire cord. Gas not included. Warranted\*. See Note on page 55. Approximately 10x10x9 inches.

9 R 20151C—Shpg. wt. 25 lbs. . . \$269.99

Arc stabilizer alone provides easy starts with AC or AC/DC.

9 R 20117C—Shpg. wt. 21 lbs. . . \$164.99

TIG\*\* torch with argon regulator and brass shut-off valve. Gas not included.

9 R 20112—Shpg. wt. 4 lbs. 12 oz. . . \$139.99

\*\*Tungsten Inert Gas. Non-combustible process producing a very high level weld quality.



### Lincoln Fleetwood rods for arc welders

Electrodes for arc welders.

Type	Size	Catalog No.	Shpg. wt.	Price
For general-purpose and mild steel jobs.				
E-6013	3/32 in.	9 R 20042	10 lbs.	\$16.99
E-6013	1/8 in.	9 R 20043	10 lbs.	15.99
For digging, cutting, piercing. Welds dirty, rusty metal in all positions.				
E-6011	3/32 in.	9 R 20045	10 lbs.	\$16.99
	1/8 in.	9 R 20046	10 lbs.	15.99
Drag rod. For general-purpose and short, irregular, poor fit up welds in flat, horizontal, or up to 45° downhill positions.				
E-7014	1/8 in.	9 R 20048	10 lbs.	\$15.99
Stainless steel electrode for welding stainless, stainless to carbon, hard-to-weld steels, unknown steel analysis.				
E-309-16	1/8 in.	9 R 20049	10 lbs.	\$49.99
Low hydrogen, all-position electrode for regular, hard-to-weld steels. Excellent restrike for skip and tack welding.				
E-7018	1/8 in.	9 R 20050	10 lbs.	\$15.99
For hardfacing and restoring steel parts (buckets, scrapers, shears, etc.).				
Abrasoweld™	1/8 in.	9 R 20051	10 lbs.	\$19.99
Nickel electrode to weld, repair cast iron. May be machined, filed after deposit.				
Softweld	1/8 in.	9 R 20052	8 oz.	\$5.99

# Welders for shop, agricultural and home automotive jobs



## Arc welders by

**LINCOLN  
ELECTRIC**

Craftsman® 225-amp AC welder has 11-position switch for the same accurate settings every time. Available in Catalog only!

**\$199<sup>99</sup>**

**\$10 MONTHLY** (see p. 148). Use this welder to hardface high-wear items or build-up worn parts. Cut and pierce holes with ease. Takes electrodes up to 3/16-inch diameter. Comes with its own clamp, work cable and electrode holder. Includes owner's manual and instructions. Rated 50 input amps. 79-volt open circuit secondary. 13x15x19 inches. See note below.

9 R 20011N—Wt. 93 lbs. . . \$199.99

**\$15 MONTHLY** (see p. 148). Includes all the fine features of 9-20011 PLUS it provides a 125-amp DC current to give you the most stable arc possible on difficult vertical and overhead jobs. Not Craftsman. See Note below.

9 R 20012N—Wt. 126 lbs. . . \$399.99

Wheel kits (not shown) add portability and convenience to your welder. Incl. axle, two 6-in. wheels and hardware.

For model 20011.

9 R 20013—Wt. 4 lbs. . . \$9.99

For model 20012.

9 R 20014—Wt. 3 lbs. . . \$9.99

Craftsman arc welders include cables, heavy-duty holder and work clamp

50-185 and 65-295-amp AC range arc welder

**\$249<sup>99</sup>**



**\$12 MONTHLY** (see p. 148). Takes electrodes to 1/4-inch diameter; low hydrogen, stainless steel electrodes to 3/16-in. diameter. 60 input amps. 80-v. open circuit secondary. Requires direct wiring. 10-ft. work cables. 15x12x21 in. See note below.

9 R 20148N—Shpg. wt. 100 lbs. . . \$249.99

**\$10 MONTHLY** (see p. 148). 35-230-amp AC unit takes electrodes to 3/16-in. diam.; low-hydrogen, stainless steel electrodes to 1/8-in. diam. 50 input amps. 74-v. open circuit secondary. Incl. 8-ft. electrode cable, 6-ft. work cables, 6-ft. power cord.

13x13x17 in. See note below.

9 R 20147N—Shpg. wt. 80 lbs. . . \$189.99

**\$13 MONTHLY** (see p. 148). AC/DC model with AC range of 35 to 230 amps; DC range 50-140 amps. Uses electrodes to 3/16-in. diameter; low-hydrogen, stainless steel to 1/8-in., aluminum 3/32-1/8-inch; 50 input amps. 74-v. AC; 80-v. DC open circuit secondary. Incl. 8-ft. work cables, 6-ft. power cord. See note below.

9 R 20189N—Shpg. wt. 97 lbs. . . \$289.99

NOTE: Arc welders (except 9-20011 and 20012) include flip-front helmet and instruction manual. Duty cycles are 20%. Check your input voltage, frequency, cycle, phase and capacity or input power with local electric utility company or REA office. NEMA-rated, UL listed. 60-HZ AC (Model 20100 is 110-120-v., others are 230-v.) Welders warranted by Sears or manufacturer. Write for free copy, see p. 148.

Compact Wire-feed Welder uses standard house current . . . it's our easiest to use

- ✓ No special wiring needed . . . just plug in and start
- ✓ Gasless . . . welds without compressed shielding gasses
- ✓ Smooth wire-feed eliminates the need for rods or electrodes
- ✓ Includes 1-lb. spool of easy-loading flux-cored, self-shielding wire . . . plus accessories



For repairing steel around the home



Great for repairing cars, trucks, bikes



Easily portable . . . weighs only 66 lbs.

**\$349<sup>99</sup>**

Available in Catalog only! Only \$14 MONTHLY (see p. 148.) Handles .035 and .045-in. diameter flux cored, self shielding wire. Welds 18-gauge to 3/16-in. steel on one pass . . . up to 1/4-in. thick with multiple passes. Dual output setting. Includes 1 lb. .035 wire, welding gun with 8-ft. cable hose, 8-ft. ground cable with ground clamp, 3 contact tips, 2 nozzles, standard helmet, wire wiper and instruction manual. 120 primary volts, 18 primary amps. 60 Hz. Single phase. 20% duty cycle at 75 amps, 100% duty cycle at lowest setting. Max. open circuit 31-v. UL listed. 20Lx9Wx17 in. high. Warranted by Sears. Write for fee copy, see p. 148.

9 R 20100N—Wt. 66 lbs\* . . \$349.99

2.5-lb. spool .035 self-shielding flux-core wire.

9 R 20095—Wt. 3 lbs. . . \$29.99

Contact tips for use with .035 wire. Package of 6.

9 R 20096—Wt. 2 oz. . . Pkg. \$3.99

2.5-lb. spool .045 self-shielding flux-core wire.

9 R 20093—Wt. 3 lbs. . . \$18.99

10-lb. spool .045 self-shielding flux-core wire.

9 R 20094—Wt. 10 lbs. . . \$59.99

Contact tips for use with .045 wire. Package of 6.

9 R 20097—Wt. 2 oz. . . Pkg. \$3.99

Nozzle for use with 9-20100.

9 R 20098—Wt. 2 oz. . . \$4.99

\*See "N" suffix note, p. 148.

# Available in Catalog only! MIG<sup>▲</sup> and TIG\* medium-duty industrial AC/DC or DC Arc Welders engineered by LINCOLN<sup>®</sup> ELECTRIC

For our Catalog Customers

## Save 50%

on a 50-pc. Rod Assortment when you also buy any welder on this page

Assortment includes 3 sizes of E-6013 electrodes and 2 sizes of E-6011 electrodes to let you start utilizing your welder right away!  
9 R 20041—Wt. 5 lbs. 1 oz. Set alone \$9.99  
Set when you also buy any welder on page . . . \$4.99



250-amp AC/DC MIG<sup>▲</sup> Arc Welder provides up to 300 amps AC output

| \$34 MONTHLY, (see p. 148). Can handle heavy maintenance and medium-duty production welding. Continuous amp control provides exact heat settings with excellent arc characteristics. Undercarriage with wheels provides easy mobility. May be used as TIG\* welder with (5), (6 and 7) attached (sold below). Provides easy welding in all positions. Use for code quality pipe welding where low range stability and a smooth arc are essential. Great for low hydrogen, stainless steel, hardsurfacing, non-ferrous, and many other electrodes. AC heat range: 35-300 amps. DC heat range: 40-250 amps. 70-v. open circuit secondary. 30% duty cycle at 250-amp output. 70 input amps at 230-v. 35 amps at 460-v. Requires direct, single-phase wiring. Order accessory kit 9 R 20183, page 57. Warranted\*\*.

F 9 R 20024N—Shpg. wt. 369 lbs . . . \$999.99

\$30 MONTHLY, (see p. 148). Similar to above, but without undercarriage or wheels. 21Lx20Wx30D-in. F 9 R 20016N—Shpg. wt. 346 lbs . . . \$899.99

2 and 3 Semi-automatic MIG<sup>▲</sup> Wire Welders designed for welding carbon and stainless steels, as well as aluminum. Provide continuous all-position welding for auto body repair, incl. HSLA (High Strength Low Alloy) sheet metal. Single spot or plug weld with adj. "on" time between .5 to 3 seconds. Stitch weld cycle on (20018, 19) is adj. and repeatable for as long as gun trigger is held closed; weld metal as thin as 26-gauge. Handle std. wire spools .023, .030, .035-in. diam. Bridge large gaps in metal fill welding. Arc voltage continuously adjusts from min. to max. Analog voltmeter. Permanently lubricated wire drive motor. Calibrated wire feed speed for accurate, repeatable heat settings. Wire drive rolls and guides minimize "bird nesting." Dynamic braking quickly stops wire, simplifying restrike. Low voltage trigger circuit. 10-ft. gun, cable assembly. Undercarriage with wheels, bottle rack (bottles, gauge not incl.). Warranted\*\*.

2 \$47 MONTHLY, (see p. 148). 150-amp DC model provides wire feed speed 50-500 in./min. 10-ft. input cord receptacle. 31 primary amps at 208-v., 28 amps at 230-v., 38 maximum open circuit secondary. 20% duty cycle at 22 arc volts. 34Lx14Wx23D-in. F 9 R 20018N—Shpg. wt. 160 lbs . . . \$1399.99

3 \$50 MONTHLY, (see p. 148). 200-amp DC model has 6-ft. cord, receptacle. 50 primary amps/208-v. 46 amps/230-v. 60% duty cycle at 26 arc volts. 26Lx23Hx31D-in. F 9 R 20019N—Shpg. wt. 325 lbs . . . \$1999.99

4 \$50 MONTHLY, (see p. 148). 250-amp AC/DC TIG\* welder is a complete maintenance and production model. Joins all carbon and stainless steels plus hard-to-weld metals such as aluminum. Remote control produces instantaneous linear output response when changing welding heat. 3-range overlapping heat controls, polarity switch for AC, DC+DC; built-in hi-frequency control, fixed gas preflow and adjustable afterflow. Thermal overload protection. AC output range: 8-275 amps. DC output range 8-250 amps. 76 maximum open circuit secondary amps. 101 input amps at 208-v., 92 amps at 230-v., 46 amps at 460-v. 60-Hz. 1-phase. Requires direct wiring. For arc start and remote current control when using TIG welding, order 9-20022 (sold below). Undercarriage incl. wheels and bottle rack. Order access. kit 9 R 20183, p. 57. Warranted\*\*.

F 9 R 20025N—Shpg. wt. 553 lbs . . . \$1699.99

\$11 MONTHLY, (see p. 148). Foot control (not shown) varies current while welding for critical TIG\* welds, crater filling. Built-in switch automatically starts, stops high frequency and welding power. Warranted\*\*.

F 9 R 20022—Shpg. wt. 10 lbs . . . \$229.99

5 \$20 MONTHLY, (see p. 148). TIG\* welder hi-frequency adapter converts any AC or AC/DC manual shop or portable arc welder into an inexpensive TIG welder. Use for production or repair of aluminum, stainless steel, carbon steel, other hard-to-weld materials. Gas solenoid, post and adj. afterflow. 25-ft. cord. Remote on/off. 115-v., 60/50 Hz. AC. 1.13 input amps. Rated at 250 amps at 80% duty cycle. Order (6, 7) below. Not recommended for use with 225-amp., 20% duty cycle or less welders. F 9 R 20017—Shpg. wt. 30 lbs . . . \$599.99

6 Has high and low pressure gauges. Includes 10 feet of gas hose and fittings. Warranted\*\*.

F 9 R 20031—Shpg. wt. 5 lbs . . . \$59.99

7 Includes 12.5 feet of electrode lead and gas hose. Collets and cup are interchangeable with most popular brands. Includes 1/8-in. collet; 1/8-in. 2° thoriated tungsten, and 3/8-in. cup. No gas bottles included. Warranted\*\*.

F 9 R 20032—Shpg. wt. 9 lbs . . . \$79.99

\*Tungsten Inert Gas ▲Metal Inert Gas

\*\*Warranted by Lincoln. Write for free copy, see p. 148.

▲See Shipping Note on page facing page.

150-amp DC MIG<sup>▲</sup> Arc Welder has adjustable wire feed speed



200-amp DC MIG<sup>▲</sup> Arc Welder is capable of feeding flux core wire



250-amp AC/DC TIG\* Welder can handle hard-to-weld metals



High Frequency Adapter converts arc welder to TIG\* welder



200-amp TIG\* Torch Assembly



Argon, argon-CO<sub>2</sub> Regulator Flowmeter

## Welding Accessories

Accessory kit includes 5 soap stones, holder, welding gloves, tip cleaners, and chipping hammer with brush. Shpg. wt. 3 lbs. 4 oz.

9 R 20038... Kit **\$23.49**

Dolly kit incl. two 5½-in. plastic wheels, steel handle and axle. Unassembled. For (9-20189N, 20147N, 20148N, 20137, 20139, 20144).

9 R 20486—Wt. 6 lbs... Kit **\$17.99**

Chipping hammer with brush for slag removal. Wt. 1 lb. 3 oz.

9 R 20037... **\$9.99**

Twin arc carbon torch for any AC or DC 230-v. arc welder. Braze, temper, solder and heat to bend or shape.

9 R 20071—Wt. 2 lbs. 7 oz. **\$34.99**

Cored carbons for welder 9-20155C; torch above. ¼x6-in. 20-40 amp heat setting. Pkg. of 8. Shpg. wt. 3 oz.

9 R 20236... Pkg. **\$6.69**

Heavy-duty helmet with flip front.

No. 10 filter. Shpg. wt. 1 lb. 13 oz.

9 R 1322... **\$17.99**

No. 10 replacement filter lens for helmet above.

9 R 13277—Wt. 1 oz... **\$1.99**

250-v. receptacle rated 50 amps. For 9-20147, 9-20189, 3-wire. Grounded 2-pole. Shpg. wt. 15 oz.

9 R 20691... **\$6.69**

25-ft. extension cord for 230-v. welders. 3-wire. Grounded.

9 R 20699—Wt. 9 lbs... **\$45.99**

## Electrodes and Brazing Rods

Size in.	Heat amps	Pkg. off	Catalog Number	Wt. lbs. oz.	Price pkg.
----------	-----------	----------	----------------	--------------	------------

Type E-7014. Contact start, instant restrike. All positions. Smooth deposit, low spatter. For dragging and short, irregular upwelds.

½x14 40-100 25 9 R 20053 1 1 **\$2.99**

½x14 100-170 14 9 R 20054 1 1 **2.99**

General-purpose plus low spatter, contact rod with igniter tip compound. Best for general use on steel.

½x9 10-60 55 9 R 20215... 9 **\$3.99**

½x14 30-90 76 9 R 20044 1 1 **3.99**

½x14 70-160 17 9 R 20047 1 1 **2.99**

Type E-7018. Low hydrogen, all-position. For regular, hard-to-weld steels. Excellent restrike for skip, tack welding.

½x14 80-120 35 9 R 20056 1 1 **\$2.99**

Type E-6011. Produces a digging, deep-penetrating arc. Great for welding dirty, rusty metal in all positions. Also cuts and pierces.

½x14 80-140 48 9 R 20055 1 1 **\$2.99**

Nickel electrode for cast-iron. May be filed or machined after deposit.

½x14 80-120 7 9 R 20211... 9 **\$7.99**

Cutting electrode. Mild steel rod, special flux for clean cuts on all metals.

½x14 160-200 15 9 R 20223 1 2 **\$3.79**

Brazing rods for carbon arc or gas torch.

½x14 ..... 33 9 R 20266 1 1 **\$8.99**

Flux-coated

½x14 ..... 14 9 R 20039... 9 **\$4.59**

Gas rod assortment includes 23 copper-coated ½-in. diam. welding rods; 56 flux-coated brazing rods, ½ and ¼-in. diam. Pkg. of 79. Shpg. wt. 3 lbs. 3 oz.

9 R 20074... Pkg. **\$16.99**

## TIG\* accessories

Catalog Number	Shpg. wt.	Price
----------------	-----------	-------

¼-in. diam. electrode.

9 R 20161 3 oz. **\$2.39**

½-in. diam. electrode.

9 R 20164 3 oz. **\$4.59**

¼-in. diam. electrode.

9 R 20166 3 oz. **\$6.99**

Cup for ¼, ½-in. electrodes.

9 R 20163 3 oz. **\$4.59**

Cup for ¼-in. diam. electrode.

9 R 20168 3 oz. **\$5.69**

\*Tungsten Inert Gas

\*\*Warranted by Sears or manufacturer. Write for free copy, see p. 148.

▲Metal Inert Gas

■Catalog numbers starting with "F" are sent directly from the factory. Allow extra time for delivery. Shipping and handling charged from Catalog Merchandise Distribution Center. "F" numbers ending "N" are unavailable. Sent from factory. Contact Sears selling unit for shipping and handling charges. Allow extra time. No C.O.D. orders.

†Priced by weight. May vary due to density of electrode flux.

‡Approximately

## MIG<sup>▲</sup> Wire Welders... the fast, easy, economical way to weld



New at Sears!  
Compact MIG<sup>▲</sup> Wire Welder runs on household current!



Versatile MIG<sup>▲</sup> Wire Welder provides long welds with minimal distortion

1 Only \$27 monthly! (see p. 148). Our new compact 90-amp MIG<sup>▲</sup> wire welder runs on std. 120-v. current. Handles .024 to .030-in. diam. wire. Welds 26-ga. and up to ¼-in. steel in one pass... up to ¼-in. thick with multiple passes; also welds stainless steel and aluminum materials. 5 heat settings. Variable wire feed control with 50 to 550-in. per minute range. Power-on indicator light. Incl. 30-ft. power cord, flip-front helmet, adj. gas pressure regulator with gauges, 2 lb., .024 wire on spool, solid state stitch welding gun, wheel kit and tank brackets. Takes 4 to 12-in. wire spools. 20 primary amps. 60-Hz. Uses 20-amp fuse. Single phase. 90 amps at 20% duty cycle, up to 100% duty cycle on lowest heat setting. 25Lx13½Wx15½H-in. height†. Warranted\*\*\*. F 9 R 20104N—Shpg. wt. 89 lbs... **\$799.99**

### Wire spools for MIG<sup>▲</sup> welders.

Metal thicknesses inches	Wire, in.	Catalog Number	Shpg. wt.		Price
			lbs.	oz.	
Steel to ¼	..... .024	9 R 2120	11	2	<b>\$67.99</b>
	..... .030	9 R 2121	3	...	<b>15.99</b>
	..... .030	9 R 2122C	33	...	<b>64.99</b>
	..... .035	9 R 2123	3	...	<b>12.99</b>
Aluminum to ¼	..... .030	9 R 2124	1	9	<b>12.99</b>

2 Only \$54 monthly! (see p. 148). Gas purge control adjusts flow or changes gases without turning on wire drive or welding current. Handles .024, .030, .035-in. diam. wire. Welds 26-gauge to ¼-in. steel in one pass—up to ½-in. thick with multiple passes. Weld aluminum to ¼-inch thick. Incl. flip-front helmet; regulator flow and pressure gauges; 10 lbs. .030 wire on spool. 6 ea.: .024, .030, .035 contact tips; welding gun; gun hose, liners for both steel, aluminum, spot stitch components; ground cable, clamp; cord, plug. 208/230 primary volts. 13.6/12 primary amps. 60-Hz. Single phase. 4.0 KVA secondary amps—100 at 20-v. output. 20% duty cycle at 100 amps. Max. open circuit voltage is 29. 18x41x41 inches height†. Warranted\*\*\*. F 9 R 20101N—Shpg. wt. 179 lbs... **\$1599.99**

## Welder/generator Outfits by Lincoln Electric

Use as auxiliary power source or TIG\* Welder with high frequency adapter, torch, p. 56



3  
150-amp, 4500-watt, AC Welder/Generator Outfit



4  
225-amp, 6000-watt, AC/DC Welder/Generator Outfit

3 As low as \$47 monthly! (see p. 148). Features a 10-HP, 4-cycle engine. AC generator control circuit provides a steady arc. 5 settings; 60, 75, 90, 105, and 120-150 amps. 115-230-v. 60-Hz. 230-v. with two outlets; 15 amps from one, 20 amps max. from two. 115-v. with two outlets; 20 amps from one, 40 amps max. from two. AC welding output: 60-150 amp range. 100% duty cycle. 25-v. auxiliary output. Manual recoil start. Undercarriage with pneumatic tires.

F 9 R 20027N—Shpg. wt. 364 lbs... **\$1399.99**

F 9 R 20028N—Electric start. Wt. 416 lbs... **\$1559.99**

Only \$44 monthly! 150-amp AC welder/generator alone is same as (3), except without undercarriage or tires. Manual, recoil start. 37Lx20Wx24H-in.††

F 9 R 20184N—Shpg. wt. 326 lbs... **\$1299.99**

Only \$49 monthly! Electric, pushbutton start. 30x20x24-in.††

F 9 R 20185N—Shpg. wt. 368 lbs... **\$1449.99**

Only \$62 monthly! 150-amp, AC/DC welder/generator outfit has AC/DC welding capability and electric, pushbutton start. AC welding output: 60-150 amp range. DC welding output: 45-125 amp range. 20x37x24 inches height††.

F 9 R 20029N—Shpg. wt. 439 lbs... **\$1849.99**

Only \$57 monthly! 150-amp AC/DC welder/generator alone, no undercarriage, tires. Elec., pushbutton start. 20x37x24H-in.††

F 9 R 20187N—Shpg. wt. 385 lbs... **\$1699.99**

4 Only \$74 monthly! (see p. 148). Elec. start engine. 16-HP, 4-cycle. 100% duty cycle at infinite heat settings from min. to max. 115/230-v. 60-Hz. AC. 230-v. with 2 outlets; 15 amps from one, 26 amps max. from two. 115-v. from four outlets. DC welding output: 50-210 amp range, 25-volts. AC output: 50-225 amp range. Undercarriage, pneumatic tires. Order access. kit below.

F 9 R 20026N—Shpg. wt. 632 lbs... **\$2199.99**

Only \$67 monthly! 225-amp AC/DC welder/generator, no undercarriage or tires. 48Lx25Wx24H-in.††

F 9 R 20181N—Shpg. wt. 570 lbs... **\$1999.99**

Accessory kit incl. headshield with filter and cover plates, electrode holder, and work clamp. 30-ft. electrode cable, 25-ft. work cable. For welders (9-20015, 16, 21, 23, 24, 25, 26, 27, 28, 29, 20181, 84).

F 9 R 20183—Shpg. wt. 15 lbs... **\$119.99**



Outfit (1)



**CRAFTSMAN®  
Oxy-acetylene  
torch outfit**

- ✓ Sears exclusive thumbwheel control lets you change to economical auto-pilot with a flick of the thumb, then back to same flame every time
- ✓ 2½-inch dials on gauges are large and easy to read
- ✓ Rugged forged brass body, regulators, cutting head and hose fittings

**\$309<sup>99</sup>**

**| \$13 MONTHLY** (see p. 148). Two pressure-tested regulators feature large, easy-to-handle adjusting knobs. Needle-type valve stems allow precise adjustments for maximum workability. Flashback-resistant mixer has double "O" rings for leak free connections. Torch has comfort-balanced handle. UL listed system includes cutting tip (No. 1), three welding tips (No. 3, 5, 7) to weld steel up to ¼ inch thick, cut steel up to 1½ inches thick. For welding capacity up to ¾ inch and cutting up to 6 inches, order additional tips at right.

Outfit also includes: rosebud heating tip to throw a broad flame that heats wide areas quickly; roller guide to allow easier, more accurate cutting of straight lines, circles and bevel angles; 20-ft. twin hose; high-grade goggles; spark lighter; wrench; how-to-weld and owner's manual; project book; and a coupon good for up to \$65 off the purchase or lease of a pair of refillable cylinders and gas contents at participating gas distributors. **Warranted**.  
9 R 20273C—Shpg. wt. 16 lbs. . . \$309.99

**Sav-fuel torch alone**  
9 R 54424—Wt. 1 lb. 7 oz. . . \$93.99

**\$11 MONTHLY**, (see p. 148). Incl. the same features as outfit (1), except does not have thumbwheel control, rosebud tip or roller guide.  
9 R 20272—Shpg. wt. 14 lbs. 12 oz. . . \$229.99

**Standard torch alone**  
9 R 54406—Shpg. wt. 1 lb. 11 oz. . . \$49.99



Accessories for outfit (1)



Roller guide for torches

**2** Craftsman regulators maintain constant gas pressure. Forged brass with 2-in. diam. dials. **Warranted**.  
Wt. 3 lbs. 4 oz.  
Oxygen  
9 R 20280 . . . \$59.99  
Acetylene  
9 R 20281 . . . \$59.99

**3** Individual welding tips for (1), all other torches, outfits, sold at left, plus 9-5431, 5441, 5444, 5446. Wt. ea. 5 oz.

Size no.	Cap. in.	Catalog Number	Price
1 . . . . .	½	9 R 54441	\$8.09
2 . . . . .	⅜-⅝	9 R 54442	8.09
3 . . . . .	⅝-⅞	9 R 54443	8.09
4 . . . . .	⅞-1	9 R 54444	8.09
5 . . . . .	1-1 ½	9 R 54445	8.09
6 . . . . .	1 ½-2	9 R 54446	8.09
7 . . . . .	2-3	9 R 54447	8.09
8 . . . . .	3-6	9 R 54448	8.09

**6** Roller guide attaches to handle of most oxy-acetylene or propane torches to provide support and help cut smooth circles, straight lines or bevel cuts.  
9 R 20282—Shpg. wt. 12 oz. . . \$19.99

**Propane torches and outfits**

**7** Only \$10 MONTHLY (see p. 148). Work with easily obtainable propane rather than acetylene gas. Two pressure-tested regulators. 2-inch dials on regulators are large and easy-to-read. Forged brass body, regulators, cutting head and hose fittings. Needle-type valve stems allow precise adjustments with maximum workability. Flashback-resistant mixer with double "O" rings for leak-free connections. Reverse-flow check valves help eliminate flashbacks and backfire. Includes 2 brazing tips, 1 cutting tip and 1 heating tip to braze metal up to ⅜ in. thick; cut steel up to 1-in. thick (up to 6 in. thick with tips sold at right). Comes with 20 feet of twin hose, goggles, spark lighter, wrench, how-to-weld and owners manual. **Warranted**.  
9 R 20172C—Shpg. wt. 14 lbs. 6 oz. . . \$199.99

\*Warranted by Sears. Write for free copy, see p. 148.

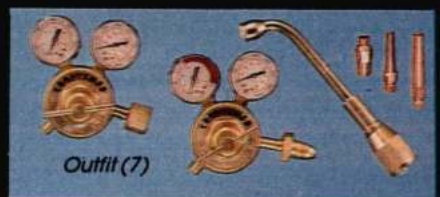

Outfit (7)

Sears deluxe propane torch outfit can handle cutting or brazing jobs in the shop or on the farm . . . using economical propane gas

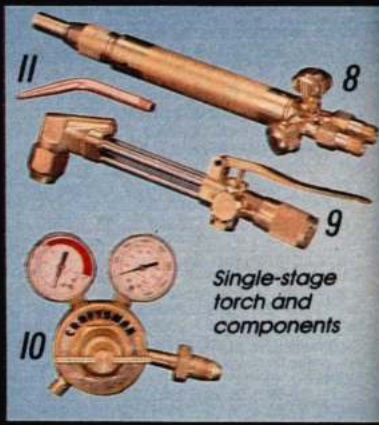

Single-stage torch and components

**4** Individual cutting tips for use with attachments 9-54408, 54422, 54425, 54407; all torches, outfits, sold at left, plus 9-5431, 5441, 5444, 5446. Shpg. wt. ea. 5 oz.

Size C. no.	Cap. in.	Catalog Number	Price
0 . . . . .	¼-⅞	9 R 54451	\$9.69
1 . . . . .	⅞-1 ½	9 R 54452	9.69
2 . . . . .	1 ½-3	9 R 54453	9.69
4 . . . . .	3 to 6	9 R 54455	9.69

**5** Size no. 2 heating tip. For all torches, outfits sold at left, plus 9-5431, 5441, 5444, 5446. Wt. 7 oz.  
9 R 54471 . . . \$22.99

**Extra tips for propane torch.**

Size	Catalog No.	Wt.	Price
Cutting tips ⅜ to 1½ in. capacity			
No. 1 . . . . .	9 R 54456	2 oz.	\$9.69
1½ to 3 in. capacity			
No. 3 . . . . .	9 R 54457	4 oz.	\$9.69
3 to 6 in. capacity			
No. 4 . . . . .	9 R 20079	2 oz.	\$9.69
Brazing tip ⅝ to ⅞ in. capacity			
No. 5 . . . . .	9 R 20080	2 oz.	\$7.99
Over ⅞ in. capacity			
No. 9 . . . . .	9 R 20081	2 oz.	\$7.99
Heating tip			
No. 9 . . . . .	9 R 20082	2 oz.	\$9.99

**8 thru 10** Single-stage torch components. Tips not incl.

Item	Cat. No.	Shpg. wt.	Price
(8) Welding torch . . . . .	9 R 54491	12 oz.	\$43.99
(9) Cutting attachment . . . . .	9 R 54402	14 oz.	46.99
MAPP adapter . . . . .	9 R 20296	6 oz.	4.99
(10) MAPP regulator . . . . .	9 R 20279	1 lb. 12 oz.	49.99
Oxygen adapter . . . . .	9 R 20297	6 oz.	4.99
Oxygen regulator . . . . .	9 R 20278	1 lb. 12 oz.	49.99

**11** Welding tips for outfits 9-5432, 9-5443, torches 9-54491, 9-54401.

Size	Capacity	Catalog No.	Wt.	Each
No. 1	up to ½ in.	9 R 54431	4 oz.	\$6.39
No. 3	½ to 1 in.	9 R 54432	4 oz.	6.39
No. 7	1 to 1 ½ in.	9 R 54434	4 oz.	6.39

**Cutting tips for attachment 9-54402 and outfit 9-5432 only (not shown).**

Size	Capacity	Catalog No.	Wt.	Each
Oxy-acetylene tips				
No. 0	¼ to ½ in.	9 R 54435	3 oz.	\$8.79
No. 1	½ to 1 in.	9 R 54436	3 oz.	8.79
No. 2	1 to 2 in.	9 R 54437	3 oz.	8.79
Propane tip				
No. 1	½ to 1 in.	9 R 54438	3 oz.	\$8.79



## Welding Accessories

Accessory kit incl. 5 soap stones, holder, leather welding gloves, adj. "C" clamp, and chipping hammer with brush.

9 R 20038—Wt. 3 lbs. 4 oz. . . Kit \$23.49

Polyethylene welding goggles fit over glasses. Adjustable headband. No. 5 filter for cuts to 6 in., welds to 5/16 in. thick. 2x4 1/2-in. window.

9 R 18636—Wt. 6 oz. . . \$10.49

Rugged leather welding gloves.

9 R 26025—Wt. 11 oz. . . \$12.99

Available in Catalog only. Steel cylinder truck for 110-cu. ft.

oxy./122 cu. ft. acetylene and 122 cu. ft. oxy./145 or 169 cu. ft. acetylene. 38 1/2 in. high. See "N" suffix note, p. 148.

9 R 5429N—Wt. 26 lbs. . . \$54.99

Flux-coated brazing rods. 3/32-in. diameter. Package of 14.\*\*

9 R 20039—Wt. 9 oz. . . \$4.59

20-ft. long rubber twin welding hose for replacement or extension. Solid brass fittings.

9 R 54271—Wt. 4 lbs. 8 oz. . . \$23.99

Welding hose same as (54271) above, except measures 12 ft. long.

9 R 20070—Wt. 2 lbs. 4 oz. . . \$16.99

Popular Science gas and electric welding handbook with illustrations. 306 pages.

9 R 20036—Wt. 14 oz. . . \$9.99

Gas rod assortment incl. 23 copper-coated 3/32-in. diam. welding rods; 56 flux-coated brazing rods 3/32 and 1/8 in. diam. Pkg. of 79.\*\*

9 R 20074—Wt. 3 lbs. 3 oz. . . \$16.99

Set of 2 reverse flow check valves.

9 R 54423—Wt. 12 oz. . . Set \$6.99

12 tip cleaners.

9 R 5424—Wt. 1 oz. . . Set \$3.69

Spark lighter includes 1 flint.

9 R 5440—Wt. 4 oz. . . 99c

Soap stone kit incl. holder, plus 5 stones for marking metal.

9 R 54476—Wt. 3 oz. Kit \$4.69

\*\*Warranted by Sears. Write for free copy, see page 148.

\*\*Quantities figured by weight; may vary (Unassembled)

■Sent from factory. Unavailable. Contact Sears selling unit for shipping and handling charges. Allow extra time. No C.O.D. orders.

5 Only \$57 MONTHLY, see p. 148. 7-in. metal cutting band saw cuts all metals in both wet and dry applications. Features 1-HP, 1725-rpm motor. Oversized 4x12-in. vise jaws open to 13 1/2 in. 45° angle capability. Cuts 7 1/4-in. diam. or 7 1/4x12-in. rectangular stock; 7 1/4-in. rounds. 4 speeds: 60, 95, 155 and 250 ft. per minute. Hydraulic down feed. Blade is 107x3/4-in. wide. 1 1/2-gal. coolant reservoir. Incl. wet cut access; submersible pump, hose, nozzle, on/off valve, splash guard and tubing. Meas. approx. 56Lx25Wx48H-in. 120-v. 60-Hz. AC. 6-ft., 3-wire cord. Warranted\*.

F 9 R 21403N—Shpg. wt. 514 lbs. . . \$1699.00

6 \$15 and \$17 MONTHLY, see p. 148. Ball bearing wheels and guides. Heavy-gauge steel base has two 4-inch wheels. Vise adjusts for miter cuts from 45° to 90°. Approx. 41x12x37 in. high in horizontal position; also may be used in vertical position. V-belt drive. 3 speeds: 85, 125, 200 ft. per minute. Incl. wet accessories: submersible pump, hose, flexible nozzle, on/off valve, hose adapter, trough and coolant tub. Has 64x1/2-in. wide blade. Cuts 4 1/2-inch diameter or 4x6-inch rectangular stock. Spring-tension feed-rate adjust. Auto shut-off when cut is completed (in horizontal position only). Inc. V-belt, pulleys, 64x1/2-in. blade (14 teeth per inch), 115v., 60-Hz. AC. 6-ft., 3-wire cord. Warranted\*.

9 R 21402N—Shpg. wt. 152 lbs. . . \$499.99

4 1/2-inch dry cut saw is same as (6) except does not have wet cutting accessories.

9 R 21401N—Shpg. wt. 142 lbs. . . \$399.99

### Band saw blades

Width in.	Teeth per in.	Catalog Number	Shpg. wt. oz.	Price, each
Alloy steel blades for 4 1/2-in. metal cutting band saws.				
64x1/2-in.	10	9 R 32341	4	\$6.99
64x1/2-in.	14	9 R 32332	4	7.99
64x1/2-in.	24	9 R 32342	4	6.99

Alloy steel blade for former saws 9-22962, 22963.

107x3/4-in. . . 14 . . . 9 R 32333 . . . 13 . . . \$8.79

Alloy steel blades for saws 9-2290, 22901, 2295, 2296, 22964.

60x1/2-in. . . 10 . . . 9 R 22926 . . . 4 . . . \$7.99

60x1/2-in. . . 14 . . . 9 R 22927 . . . 4 . . . 7.99

60x1/2-in. . . 24 . . . 9 R 22929 . . . 4 . . . 7.99

Alloy steel blades for 9-21403 and former 7-in. band saws 9-22968 and 22969.

107x3/4-in. . . 10 . . . 9 R 22294 . . . 14 . . . \$19.29

107x3/4-in. . . 14 . . . 9 R 22293 . . . 15 . . . 19.29

Available in Catalog only! CRAFTSMAN® 7-inch wet/dry metal cutting Band Saw

**\$1699**

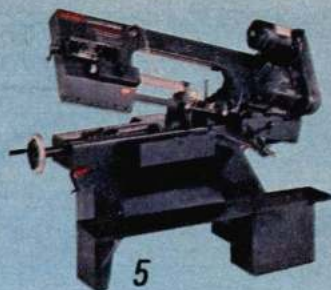

**\$499.99**

Available in Catalog only!

Sears 4 1/2-in. wet/dry metal cutting Band Saw Outfit has features like these:

- ✓ Split-phase, 1725-rpm motor rated 1/2-HP
- ✓ Precision-ground, cast-iron head
- ✓ Saw that swings to vertical position for specialty cuts

Available in Catalog only! Compact portable manual Tool and Parts Washer for the home or small shop . . . includes cleaning brush and solvent

**\$49.99**



7 High-density polyethylene unit has hand pump that sends liquid solvent from 2-gal. solvent tank to wash and rinse tank. Incl. drain basket. Pistol-grip sprayer. Meas. 23Lx13Wx8H-in.

9 R 20030—Shpg. wt. 9 lbs. 12 oz. . . \$49.99

Parts wash concentrate.

9 R 20068—16-oz. btl., Wt. 1 lb. 5 oz. . . \$4.99

9 R 20069—32-oz. btl., Wt. 2 lbs. 8 oz. . . 7.99

8 Only \$10 MONTHLY, see p. 148. Has pump that sends liquid solvent from detachable 5-gal. solvent tank into sink to clean and degrease small parts and tools. Steel sink; polyethylene tank. Measures 26 1/2Lx14 3/4Wx13H-in.

9 R 20033C—Shpg. wt. 38 lbs. . . \$199.99

9 Steel stand for (8) is 26 1/2Lx14 1/4Wx25 1/2H in.

9 R 20034C—Shpg. wt. 24 lbs. . . \$69.99

Save \$10 when you buy complete outfit (8) and (9).

Separate prices total \$269.98.

9 R 20035C—Shpg. wt. 85 lbs. . . \$259.98

8

Available in Catalog only!

Commercial-style bench top electric Tool and Parts Washer (8)

**\$199.99**

Steel Stand (9)

**\$69.99**

Save \$10 when you buy complete outfit (8) and (9)

**\$259.98**



9

# CRAFTSMAN Plumbing Tools and Accessories for household and professional use

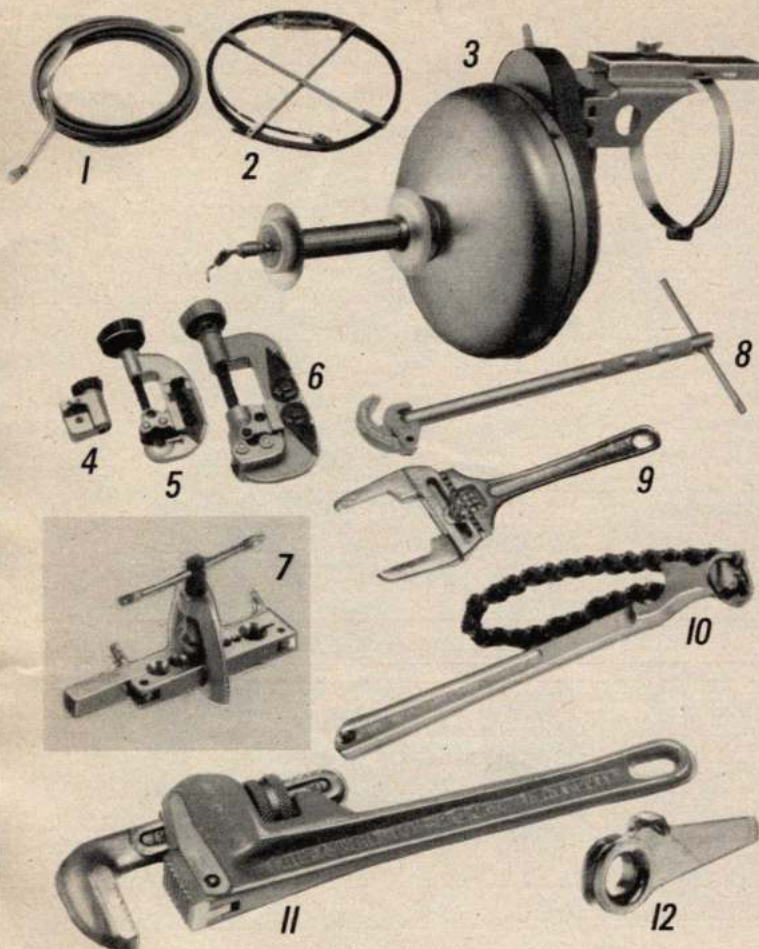

**1** Drain and trap augers of  $\frac{3}{8}$ -in. wide steel spring coil.

25 ft. long.  
9 R 55345—Wt. 12 lbs. . . \$19.99

75 ft. long.  
Available at Sears only in Catalog.  
9 R 55391C—Wt. 12 lbs. . . \$36.99

**2** Available at Sears only in Catalog.  
Flat sewer coil has revolving spear point. 100 ft. long.  $\frac{3}{4}$ -in. wide,  $\frac{1}{8}$ -in. thick. Snake steel.  
9 R 55092C—Wt. 32 lbs. . . \$89.99

**3** Available at Sears only in Catalog.  
CRAFTSMAN auger uses  $\frac{1}{4}$ ,  $\frac{3}{8}$  or  $\frac{1}{2}$ -in. drill (not included). Rust-resistant canister holds  $\frac{1}{4}$  x 25-ft. coil of piano wire.  
9 R 55472—Wt. 8 lbs. 8 oz. . . \$46.99

Extra heavy-duty auger. 50-ft. coil.  
9 R 55475—Wt. 11 lbs. 8 oz. . . \$99.99

Replacement steel coils for augers.

Lgth. foot	Coil Type	Catalog Number	Wt. lbs. oz.	Price
25	heavy-duty	9 R 55355	3 3	\$14.99
25	extra H.D.	9 R 55477	3 4	29.99
50	extra H.D.	9 R 55478	7	54.99

**4** CRAFTSMAN Midget tubing cutter has  $\frac{1}{4}$  to  $\frac{3}{8}$ -in. diam. range.  
9 R 5561—Shpg. wt. 4 oz. . . \$7.49

**5** CRAFTSMAN Standard tubing cutter takes up to  $1\frac{1}{2}$ -in. diam. tubing.  
9 R 5533—Shpg. wt. 9 oz. . . \$8.49

**6** CRAFTSMAN Heavy-duty tubing cutter has  $\frac{1}{4}$  to  $1\frac{1}{2}$ -in. diam. range.  
9 R 5528—Wt. 1 lb. 3 oz. . . \$9.99

Replacement cutter for (5 and 6).  
9 R 5529—Wt. 1 oz. . . \$1.99

**7** CRAFTSMAN Flaring tool set for 7 thinwall sizes,  $\frac{3}{16}$  to  $\frac{1}{2}$ -in. outside diam.  
9 R 5537—Wt. 2 lbs. 1 oz. . . \$18.99

**8** CRAFTSMAN basin wrench has self adjusting jaws with return spring.  $1\frac{1}{8}$ -in. capacity. 11 in. long.  
9 R 55686—Wt. 1 lb. 2 oz. . . \$9.99

**9** Slip and locknut wrench has  $\frac{3}{4}$  to 3-in. cap.  $10\frac{1}{4}$  in. long. Imported. Not Craftsman.  
9 R 55651—Wt. 1 lb. 10 oz. . . \$9.99

**10** CRAFTSMAN Reversing pipe wrench has 15-in. chain for gripping pipe up to 4-in. outside diameter.  
9 R 55713—Wt. 1 lb. 12 oz. . . \$15.99

Tee handle reamer (not shown) for deburring or enlarging  $\frac{1}{8}$  to  $\frac{1}{2}$ -in. holes in steel or plastics.  
9 R 5479—Wt. 4 oz. . . \$7.49

**11** CRAFTSMAN steel pipe wrenches have 1-pc. housing, frame and handle for strength and durability.

Size in.	Cap. in.	Catalog Number	Wt. lbs. oz.	Price
10	1 $\frac{1}{2}$	9 R 55676	1 11	\$12.99
14	2	9 R 55677	3 5	15.99
18	2 $\frac{1}{2}$	9 R 55678	5 5	20.99

**12** CRAFTSMAN tube bender bends copper, brass brake lines and Bundy weld tubing without kinks.

Small. For 0 to  $\frac{1}{4}$  in. O.D. tubing to 360°.  
9 R 46771—Shpg. wt. 4 oz. . . \$2.29

Large. For  $\frac{1}{8}$  to  $\frac{1}{2}$  in. O.D. tubing.  
9 R 46772—Shpg. wt. 10 oz. . . \$3.69



6-pc. Pipe Threader Kit  
\$139.99

13



7-pc. Plumbing Kit  
\$169.99

14



## SUPER-EGO Plumbing Tools are ruggedly built for professional use and have a FULL UNLIMITED WARRANTY\*

**13** \$10 monthly†. Enclosed ratchet system for smoother, easier threading. Incl. 2-pc. handle, ratchet head with 4 drop-heads,  $\frac{1}{2}$ ,  $\frac{3}{4}$ , 1 and  $1\frac{1}{4}$ -in. dies which can be reversed in head. Shpg. wt. 13 lbs. 4 oz.  
9 R 52143 . . . \$139.99

**14** \$10 monthly†. Enclosed ratchet threader, 3 threading heads with  $\frac{1}{2}$ ,  $\frac{3}{4}$  and 1-in. dies, 14-in. pipe wrench, steel pipe cutter  $\frac{1}{2}$  to  $1\frac{1}{4}$  in. cap., plumber's pliers 0 to  $1\frac{1}{4}$  in. cap.  
9 R 52137C—Wt. 17 lbs. . . \$169.99

Interchangeable die heads for (13, 14)

Size in.	Catalog Number	Wt. lbs. oz.	Price
$\frac{1}{2}$	9 R 52132	1 5	\$19.99
$\frac{3}{4}$	9 R 52133	1 8	19.99
1	9 R 52134	1 11	24.99
$1\frac{1}{4}$	9 R 52135	1 13	24.99

**15** Pipe vise has v-shaped rest. Anchors to workbench. V-jaws hold pipe securely. Pipe bending accessories included.  
9 R 52147—Wt. 12 lbs. 8 oz. . . \$89.99

**16** Tubing cutter for copper, brass, aluminum and plastic pipe from  $\frac{1}{4}$  to 2 $\frac{1}{2}$ -in. diam. Fast cutting wheel approach has automatic spring return. 2 grooved rollers. 1 plastic, 1 copper-brass tube cutting wheel incl.  
9 R 52144—Wt. 1 lb. 10 oz. . . \$29.99

Repl. plastic cutting wheel for (16).  
9 R 52150—Wt. 1 oz. . . \$2.99

Replacement copper/brass cutting wheel.  
9 R 52148—Wt. 1 oz. . . \$2.99

†See page 148

**17**  $\frac{1}{2}$  to 2 in. cap. pipe cutter has adjusting bar with knurled areas for quick advance and return of slide. Sliding roller block with shock absorber helps prevent cracking replaceable cutting wheel on uneven pipes.  
9 R 52146—Wt. 5 lbs. 12 oz. . . \$34.99

Replacement cutting wheel for (17)  
9 R 52149—Wt. 1 oz. . . \$4.99

Pipe Cutter like (17).  $1\frac{1}{4}$ -in. cap.  
9 R 52139—Wt. 2 lbs. 8 oz. . . \$29.99

**18** Flaring tool for 45° flares on soft copper tubing. 8 sizes from  $\frac{3}{16}$  to  $\frac{3}{4}$ -in. Bars have centering point for exact yoke positioning. Yoke has clamping nose for gripping with a vise.  
9 R 52145—Wt. 3 lbs. 2 oz. . . \$29.99

**19** Pipe wrench has heavy duty monoblock cast-iron handle, forged, tempered steel lower and dual heat-treated steel upper jaw. Tempered knurled adj. nut. Flat coil springs for instant gripping, ratchet action.

Lgth in.	Cap. in.	Catalog Number	Wt. lbs. oz.	Price
10	1 $\frac{1}{2}$	9 R 30841	1 11	\$16.99
14	2	9 R 30842	3 6	19.99
18	2 $\frac{1}{2}$	9 R 30843	5 6	24.99
24	3	9 R 30844	8 10	36.99

**20** 10 in. pliers have special jaw constr. for use as a pipe wrench. Use like regular wrench with hex nuts. Chrome-vanadium steel.  $1\frac{1}{4}$ -in. capacity.  
9 R 52136—Wt. 13 oz. . . \$9.99  
\*Warranted by manufacturer. Write for free copy, see page 148. Imported.

## CRAFTSMAN® Torches tackle all the jobs from soldering to thawing frozen pipes

Torches include either 14.1 oz. propane or 16 oz. by wt. Mapp® gas cylinders. See note below. See "N" suffix note, page 148.

1 Propane Torch has special regulator filter that permits use in any direction. Includes pencil flame burner tip and 14.1 oz. cylinder. Shpg. wt. 2 lbs. 6 oz. 9 R 54257N...\$9.49

Propane cylinder holds 14.1 oz. by wt. 26.7 fluid oz. See note below. 9 R 5491N—Wt. 2 lbs...\$1.99

2 Spark lighter. Shpg. wt. 4 oz. 9 R 5440...99¢

Pkg. of 5 replacement flints for lighter. Shpg. wt. 2 oz. 9 R 54405...Pkg. 79¢

Mapp® Gas Cylinder holds 16 oz. by wt. Shpg. wt. 2 lbs. 3 oz. 9 R 54921...\$5.79

3 Mapp® Gas Torch Kit brazes metal up to ¼ in. thick. Pencil-style burner. Includes 5 brazing rods, box, instructions. Shpg. wt. 2 lbs. 12 oz. 9 R 54274N...\$18.99

NOTE for items (1 thru 5): Alaska and Hawaii customers. Propane and Mapp Gas Cylinders must by law, be shipped via surface transportation. Contact local selling unit before ordering. Allow extra time for delivery.

4 Mapp® gas/oxygen Torch Kit produces high temperatures for heavy brazing, light welding of steel to 3/16 in. thick. Cuts steel bar/rod to 3/8 in. diam. Includes 16 oz. by wt. Mapp gas cylinder, 1.1 cu. ft. oxygen cylinder, Mapp control valve, oxygen regulator, cylinder support, 4½ ft. hose, 2 welding and 3 brazing rods, goggles, igniter, 6 flints, instructions and polypropylene case. Shpg. wt. 5 lbs. 8 oz. 9 R 54282N...\$47.99

Oxygen cylinder for (4) 1.1 cu ft. Shpg. wt. 1 lb. 6 oz. 9 R 54916N...\$7.49

5 Torch lights by simply opening a valve and pulling the trigger. Ceramic igniter has trigger lock to maintain flame. Precise mixing combined with high-intensity burner tube produces efficient swirl-action brazing flame. 4 ft. hose. Solid brass valves, threads. Polypropylene torch casing. Shpg. wt. 4 lbs. 3 oz. 9 R 54269N...\$37.99

Instant ignition torch that attaches directly to cylinder. No hose needed. Shpg. wt. 2 lbs. 14 oz. 9 R 54268N...\$27.99



### CRAFTSMAN Instant Ignition Torch Kit

- ✓ Instant-on high intensity brazing flame
- ✓ Convenient pistol-grip control
- ✓ Stainless steel burner tube, trigger



Small head Branding Iron

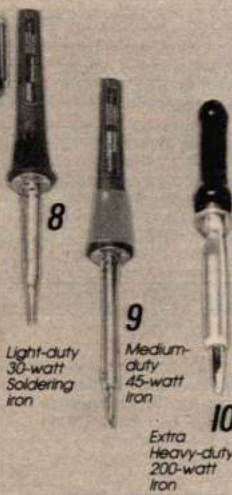

Light-duty 30-watt Soldering iron

Medium-duty 45-watt iron

Extra Heavy-duty 200-watt Iron



100-watt Soldering Gun



100-140 watt Soldering Gun



150-230 watt Soldering Kit



150-400 watt Soldering Gun



Soldering Station for precise work at select temperatures Available in Catalog only!

- ✓ Solid-state temperature control
- ✓ True heat control
- ✓ Select temp. from 460°-850°F

## Branding Irons

6 and 7 Available in Catalog only! Identify your tools or create designs on wood and leather. Kit includes 4 woodburning and leathercraft points, wire stand iron and case. Customized large head has full name. Example: "Property of Doug Alcox". Small head has up to 3 initials: D.J.A. State name or initials. Sent from factory. Shpg. and handling charged from our Catalog Mds. Dist. Center. Allow 4-6 weeks for delivery. No COD's.

6 Small. 23-watt. Shpg. wt. 1 lb. 6 oz. F 9 R 54061V...\$12.99

7 Large. 125-watt. Shpg. wt. 2 lbs. 4 oz. F 9 R 54062V...\$29.99

## Soldering Irons and Guns are ideal for home repair and electrical work

8 thru 10 Pencil-type soldering irons are ideal for fine wiring jobs. Mica-insulated, nichrome heating element with replaceable nickel-plated copper tips. Insulated plastic handle. UL listed AC.

8 30-watt iron develops 700°F tip temperature. 5/16 in. conical tip. 4½-ft. cord. 9 R 54041—Shpg. wt. 5 oz...\$7.49

9 CRAFTSMAN 45-watt tip develops 900°F. Easy-grip handle. Incl. 7/32, 1/8 in. conical, 7/32 in. chisel tip and stand. 6-ft. cord. 9 R 54042—Wt. 5 oz...Kit \$13.99

10 Available in Catalog only! CRAFTSMAN® 200-watt iron has 5/16 inch tapered screwdriver type plated copper tip that heats to 950°F. Precision-wound heating element. 3-wire, 3-ft. cord.\* 9 R 53867—Wt. 1 lb. 14 oz...\$34.99  
Replacement tip for (10) above. 9 R 53835—Shpg. wt. 12 oz...\$6.99

\*Warranted by Sears. Write for free copy. see p. 148.

11 Sears gun heats to 750°F in 9 sec. Steel-plated tip. Break-resistant housing. 4½-ft. cord. UL listed AC.\* 9 R 54035—Wt. 1 lb. 14 oz...\$13.99

12 CRAFTSMAN gun features dual heat settings. Reaches 950°F on high, 750°F on low with max. heat in 9 sec. Steel plated tip held by slotted screws. Trigger control and built-in worklight. High-impact plastic housing. 6 ft. cord. UL listed AC.\* 9 R 54036—Wt. 2 lbs. 1 oz...\$18.99

13 CRAFTSMAN heavy-duty gun kit reaches 1100°F on high, 950°F on low with max. heat in 9 seconds. Long-reach steel plated tips held by slotted screws. Hi-impact plastic housing with built-in worklight. Includes plastic cutting tip, general purpose tip, soldering aid, electrical (60% tin, 40% lead) rosin core solder and plastic case. 6-ft. cord. UL listed AC.\* 9 R 54038—Wt. 3 lbs. 5 oz...\$27.99

14 Trigger-activated gun develops tip temperature of 1000°F. Nickel-plated 1/4-inch diam. tip. Lightweight, transformerless construction for easier handling. Built-in worklight. 4½-ft. cord. 9 R 53746—Wt. 1 lb. 8 oz...\$39.99

Repl. heating element for (14). 9 R 53747—Shpg. wt. 5 oz...\$19.99

15 Soldering station uses zero voltage circuitry to protect sensitive components. Select temperature by dialing. 40 watts of power instantly stabilizes selected temp. Thermocouple heat sensor detects temp. fluctuations. Positive grounding of tip and element helps prevent static electricity discharge. Element connected to a 5-prong plug. Rocker switch with indicators for "on" and heat recovery mode. Incl. wire stand, tip cleaning sponge, 4½ ft. 3-wire cord. 9 R 53865—Wt. 2 lbs. 4 oz...\$129.99

# Analog or digital multimeters

## Analog multimeters



Multimeter has 50,000 ohms/volt sensitivity; tests batteries under load for truer readings

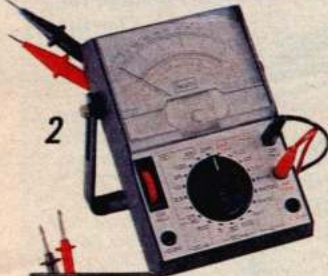

## Digital Multimeters for high accuracy



## Clamp-on meters for difficult to read areas



Craftsman® battery tester



Professional AC/DC voltage tester

1 thru 6 Sears multimeters measure electric current, voltage, resistance and more. Analog models (1 thru 3) are ideal for students, homeowners or hobbyists. They test amps, volts, ohms and decibels. Accuracy is  $\pm 3\%$  DC,  $\pm 4\%$  AC. (1) has battery tester for 1.5-v. "AAA," "AA," "C," "D" and 9-v. batteries; (3) tests "AA," "C," "D" and 9-v. batteries—all under actual loads for accuracy. Single-knob selector switches with fused circuitry and diode-protected movements. (1) takes 1.9-v., 1 "AA" battery; others use 9-v. battery (batteries not incl.). (2 and 3) incl. case. Digital models (4 thru 6) have highly-visible LCD readout for extremely accurate readings throughout range. (5) selects proper range automatically. 10 megaohm input impedance. Fully overload protected; safety designed to UL Std. 1244. Has overrange, data hold, and low battery indicator. May be used for diode testing. Uses 9-v. battery (not incl.). Incl. two 36-in. test leads; (6) also incl. test lead for capacitance check, and temperature probe. (1 thru 6) imported. Warranted\*

Specification and ordering chart for analog multimeters

Item	(1)	(Not shown)	(2)	(3)
No. of Ranges	41	43	27	15
Sensitivity—DC: Ohms/volt	50,000	50,000	20,000	2,000
Measurement Range: Ohms	20M	20M	6M	500K
AC	1000-v.	1000-v.	1000-v.	1000-v.
DC-A	500-mA	500-mA	500-mA	500-mA
Decibel Range	-20 to +62	-20 to +62	-22 to +62	-22 to +62
Battery Testing	Yes	No	No	Yes
Mirrored Scale	Yes	Yes	No	No
Test lead length	44-in.	44-in.	37-in.	27-in.
Catalog Number	9 R 82364	9 R 82363	9 R 82362	9 R 82361
Shipping weight	1 lb. 6 oz.	1 lb. 6 oz.	13 oz.	6 oz.
Price	\$39.99	\$36.99	\$18.99	\$13.99

Vinyl case for (1) and 9-82363. (Not shown)

9 R 82379—Shipping weight 6 oz. . . \$5.49

Specification and ordering chart for digital multimeters

Item	(4)	(5)	(6)
No. of ranges	14	20 in manual mode	36
Accuracy—DC/AC	$\pm 0.5\% \pm 1.2\%$	$\pm 0.5\% \pm 0.75\%$	$\pm 0.25\% \pm 0.15\%$
DC voltage	2000 mv to 1000 v. in 4 ranges	200 mv to 1000 v. in 5 ranges	200 mv. to 1000 v. in 5 ranges
AC voltage	200 v. to 750 v. in 2 ranges	2 v. to 750 v. in 4 ranges	200mv. to 750 v. in 6 ranges
DC current	2000 $\mu$ A to 10 A in 3 ranges	200 mA to 10 A in 2 ranges	200 $\mu$ A to 10 A in 6 ranges
AC current		200 mA to 10 A in 2 ranges	200 $\mu$ A to 10 A in 6 ranges
Resistance (ohms)	2000 to 2000 K in 4 ranges	200 to 20 M in 2 ranges	200 to 20 M in 6 ranges
Other testing capabilities			Capacitance Conductance Temperature Transistor
Other special features	RF shielding	Audible and visual overrange indicator, Audible continuity	Continuity buzzer
Catalog Number	9 R 82411	9 R 82412	9 R 82413
Shpg. wt.	8 oz.	8 oz.	12 oz.
Price	\$34.99	\$74.99	\$94.99

9 R 82377—Case for (4) (not shown). Shpg. wt. 2 oz. . . \$3.99

9 R 82378—Case for (5, 6). Shpg. wt. 3 oz. . . \$4.49

7 thru 9 Clamp-on meters take power line measurements without disconnecting or penetrating line. Tests AC voltage, amperage and resistance. Fused. Imported. Batteries not incl. Warranted by Sears, write for free copy, p. 148.

7 Analog meter has 9 ranges. Tests AC current to 600 amps, AC voltage to 600-v. resistance to 2K ohms. Takes one 1.5-v. "AA" battery. 8x3x1-in. high. Case sold below.

9 R 82395—Shipping weight 1 lb. 8 oz. . . \$37.99

9 R 82376—Case for (7). Shpg. wt. 5 oz. . . \$3.49

8 Rotary meter presents one range at a time to reduce possible scale reading errors. 10 test ranges; 5 for AC current, 3 for AC-v., 2 for resistance to 5K. Tests up to 300 amps AC, 600-v AC. Locks in readings in dim light situations. 9x3x2-in. high. Takes one 1.5-v. "AA" battery. Case included.

9 R 82396—Shipping weight 1 lb. 10 oz. . . \$44.99

9 Digital meter has 6 ranges that measure up to 1000 amps AC current in 3 ranges, 750-v. AC in 2 ranges, 2K $\Omega$  resistance. Accuracy to  $\pm 1.2\%$  AC current,  $\pm 1.0\%$  AC-v.,  $\pm 0.7\%$  resistance. Data-hold switch with peak hold function. 3 1/2 digit LCD. 10x4x1-in. Uses one 9-v. batt. Case included.

9 R 82397—Shipping weight 1 lb. 12 oz. . . \$74.99

10 Test batteries from 1.35-v. hearing aid type to 22.5-v. batteries. Easy-to-read scales tell whether battery is good or needs replacement. Selector knob has sep. readings for AAA, AA, C, D, 9-v., 6-v., lantern, button, and photo batteries. Self-storing 8 1/4-in. leads. Warranted by Sears, write for free copy, p. 148.

9 R 82307—Shipping weight 5 oz. . . \$9.49

11 Voltage tester detects 120 to 600-v. AC or DC. Checks continuity, determines DC polarity. Checks fuses, ground, leakage. Has voltage indicators, solenoid indicator with scale, neon test lamp. Imported.

9 R 82337—Shipping weight 13 oz. . . \$15.99

62-63



100-pc. electrical repair kit



40-pc. electrical soldering kit



37-pc. general purpose electrical kit



50-pc. automotive repair kit

## Terminal kits for repairing most appliances and car electrical systems

12 This 100-pc. standard electrical repair kit includes crimping tool with insulated handles, bolt cutter; ten 12-10 ga. closed end splices; 20 assorted ga. spade; 24 ring terminals; 26 assorted ga. butt connectors; 5 male, 5 female quick-disconnects; 5 male, 5 female round plugs. Shpg. wt. 1 lb. 5 oz. 9 R 6088 . . . \$6.49

13 40-pc. kit incl. steel crimping tool with insulated handles, bolt cutter; needle nose, diagonal nose pliers; slotted and Phillips screwdrivers; 30-35-w. soldering iron; soldering aid; heat sink; iron rest; 30 terminals and connectors; case. Shpg. wt. 2 lbs. 4 oz. 9 R 82131 . . . \$18.99

14 37-pc. general-purpose electrical repair kit has neon tester for checking outlets to 500-v. AC/DC. Also incl. 9-in. steel crimping tool with insulated handles; long-nosed pliers; 30-ft. electr. tape; slotted, Phillips screwdrivers; 30 assorted terminal and connectors; case. Shpg. wt. 2 lbs. 9 R 6079 . . . \$13.99

15 50-pc. kit incl. spark tester, 6-12-v. electrical tester, battery fluid tester. Also incl. crimping tool with wire stripper, bolt cutter; air pressure gauge, long-nose pliers; screwdriver with 6 tips; battery terminal post cleaner; 2 elastic tie-downs; 30-ft. electrical tape; 9-ft. of 14-ga. wire; 2 taillight bulbs; 4 ignition terminals; 4 auto fuses; 29 assorted terminals and connectors; case. Shpg. wt. 4 lbs. 6 oz. 9 R 82141 . . . \$29.99

Available at Sears in catalog only—this 40-pc. automotive electrical repair kit has neon tester for up to 500-v. AC/DC continuity tester pinpoints malfunctions in circuits less than 10 ohms, 6-12-v. DC tester. Also includes crimping tool with insulated handles, bolt cutter; long-nose pliers; 30-ft. electrical tape; 10-ft. of 14-ga. wire; slotted, Phillips screwdrivers; two each; 20, 30 amp glass auto fuses; 26 assorted terminals and connectors; case. Instructions included. Shpg. wt. 2 lbs. 2 oz. 9 R 6078 . . . Kit \$15.99

## Electrical wiring tools

16 Heavy-duty automatic wire stripper strips insulation from 22 to 8 ga. stranded or solid wire. 9 R 82565—Wt. 12 oz. . . \$13.99

17 Multipurpose electrical tool with insulated handles cuts, strips 10 to 22-ga. wire, cuts bolts, uses confined trapezoid crimps for proper connections. 9 R 82566—Wt. 9 oz. . . \$4.49

18 1/2-in. dia. Thinwall conduit bender has degree scale. 9 R 82572—Wt. 2 lbs. 6 oz. . . \$24.99  
Bender for 3/8-in. diam. conduit. 9 R 82571—Wt. 1 lb. 6 oz. . . \$15.99

19 Fish tape reel lets you pull wire thru walls and conduit.

Length	Catalog No.	Shpg. wt.	Price
50-ft.	9 R 82575	2 lbs. 7 oz.	\$18.99
100-ft.	9 R 82576	4 lbs. 8 oz.	\$34.99

\*Warranted by Sears. Write for free copy, see p. 148.

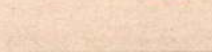

# Wiring accessories offer real convenience

**1** Power outlet center has 8 grounded outlets and built-in circuit breaker. Hi-impact plastic housing. Wall or surface mount. Rated 15 amps. 14 ga., 3-wire, 6-ft. cord. UL listed. 9 R 83632—Wt. 1 lb. 13 oz. . . \$13.99  
**Power strip with 6 outlets.**  
 9 R 83631—Wt. 1 lb. 8 oz. . . \$12.99

**2** Durable metal power strip provides 6 grounded outlets for home, shop use. Built-in circuit breaker. Wall or surface mount. Rated 15 amps. 14 ga., 3-wire, 6-ft. cord. UL listed. Almond color aluminum housing. 9 R 5769—Wt. 2 lbs. . . \$15.99  
**Red color outlet strip like above.**  
 9 R 83912—Wt. 2 lbs. . . \$15.99

**3** Unobtrusive 48-in. Plugmold® surface strip provides 8 grounded outlets in a sleek, stylish, almond-color metal strip that blends in with your room's decor. Ideal along baseboards or countertops. Rated 15 amps. Circuit breaker. 5-ft. cord. UL listed. 9 R 83642—Wt. 3 lbs. 14 oz. . . \$27.99

36-in. long Plugmold® surface strip similar to (3) below, left with 6 outlets. 14 ga. 6-ft., 3-wire cord. 9 R 83641—Wt. 3 lbs. 1 oz. . . \$24.99

**4** End the problem of tangled extension cords with this cord reel. Shatter-resistant case holds 25-ft. of heavy-duty 16 ga. 3-wire cord. 4 grounded 10 amp outlets with circuit breaker protection allow you to plug in several appliances. Monitor light. UL listed. 9 R 83918—Wt. 3 lbs. 8 oz. . . \$18.99

**5** Retractable cord reel holds 30 feet of heavy-duty 16-ga., 3-wire cord for instant use. Just pull out what you need. Another tug and it's back in the reel, out of the way. Molded tap has 3 grounded outlets. Mounts on wall, work bench or ceiling. UL listed. 9 R 83928—Wt. 9 lbs. 4 oz. . . \$32.99

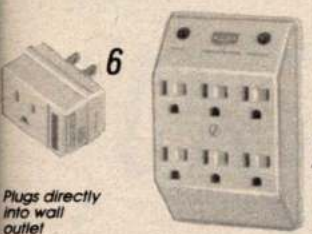
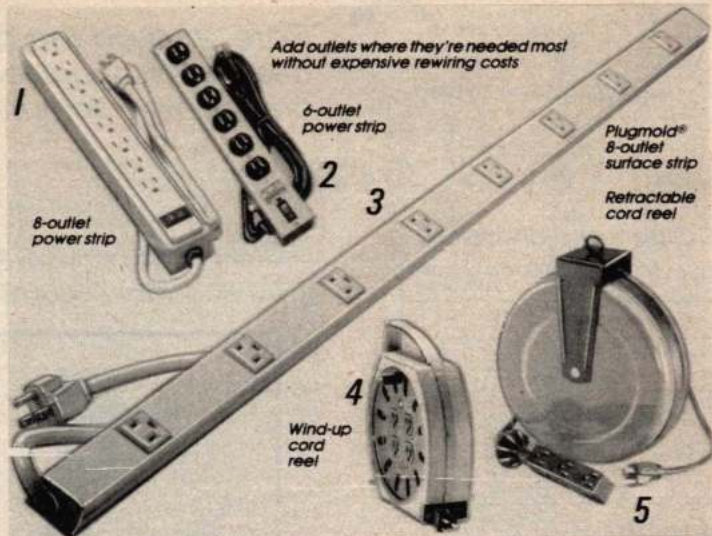

Plugs directly into wall outlet



Surge suppressors



Strip-type for audio, video or computer equipment



Ground-fault circuit interrupters

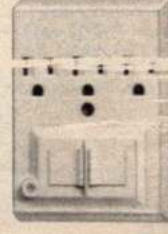

**WHAT IS A SURGE SUPPRESSOR?** This electronic device protects the electronic circuitry of microwave ovens, power tools, computers and peripherals, audio and video components from damage caused by momentary fluctuations in voltage. These outbursts of energy (spikes), as high as 40,000 volts, can seriously damage equipment by physically "shocking" these circuits. Surge suppressors have special circuits which sense these "spikes" and divert them to prevent costly damage to your equipment.

**6 thru 9** These surge suppressors offer two levels of protection for your electronic equipment, tools and appliances ranging from full to superior protection. Full protection covers hot, neutral and ground lines. Also protects against RFI and EMI. Superior protection covers all 3 lines and have heavy-duty RFI, EMI protection and audible alarm to warn you when unit itself has been damaged. UL listed.

RFI is radio frequency interference. EMI is electromagnetic interference. Either can garble computer programming, cause static on radios and noise on video screens. Plug-in units have grounded outlets and monitor light that indicate unit is working. Power strips have grounded outlets, monitor light, 14 ga. 3-wire, 6-ft. cord.

**WHAT IS A GROUND FAULT CIRCUIT INTERRUPTER?** Unlike fuses or circuit breakers which protect electrical wiring, these devices help protect people from electrical shock due to faulty appliances or ground faults (short circuits) in damp or wet locations. Ground fault circuit interrupters sense dangerous ground faults and interrupt power instantaneously to help prevent serious injuries.

Ideal for areas where damp or wet conditions are present such as basements, bathrooms, kitchens, workshops, pool and patio areas. For maximum safety, replace all regular outlets with ground fault circuit interrupters. UL listed.

**10** Duplex outlet model wires into existing outlet box. Test indicator tells if unit is operating correctly. Max. 1500-w. 120-v. AC. 9 R 81931—Shipping weight 5 oz. . . \$15.99

**11** Triple outlet model plugs into existing grounded outlet for instant protection. Self-test mode. 1500-w. max. 120-v. AC. 9 R 81932—Shpg. wt. 12 oz. . . \$24.99

Item no.	No. of outlets	Outlet type	PROTECTION LEVELS		Response time nanoseconds	Circuit breaker	Housing type	Catalog Number	Shpg. wt.		Price
			Full	Superior					lbs.	oz.	
(6)	1	plug-in	x		10	no	phenolic	9 R 83672	2		\$7.49
(7)	6	plug-in	x		10	no	plastic	9 R 83674	8		13.99
(8)	6	strip	x		10	yes	phenolic	9 R 83676	10		18.99
(9)	6	strip		x	0.5	yes	aluminum	9 R 83633	2		27.99

## CIRCUIT-TRAK™ wiring system

CIRCUIT-TRAK is the first plug together electrical home wiring system offered in the market for the do-it-yourselfer. Completely pre-wired to mount on your wall or ceiling . . . just plug it together as you go! Starter connectors plug into an existing outlet or may be permanently wired. Receptacles feature auxiliary switch to allow resetting to "always on" or "switched" operation. Aluminum traks and module covers can be painted to match your decor. Incl. hardware, instructions. UL listed (except 16). 125-v., 15 amp.

### Typical installations

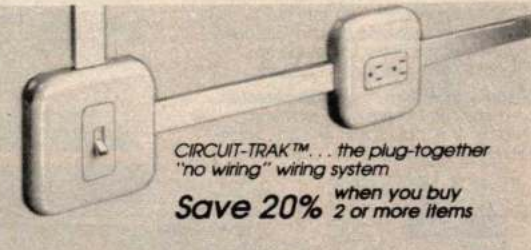
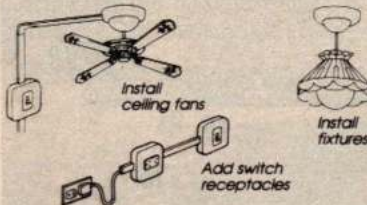

CIRCUIT-TRAK™ . . . the plug-together "no wiring" wiring system  
**Save 20%** when you buy 2 or more items

**12** General purpose switch controls system. Switch can be isolated to create sub-circuits. Wt. 13 oz. 9 R 81241 . . . Ea. \$9.99; 2 or more Ea. \$7.99

**13** Receptacle mounts anywhere in circuit. Can be set to "always-on" or "switch-operated" mode. Wt. 13 oz. 9 R 81242—Ea. \$9.99 2 or more—Ea. \$7.99

**14** Ceiling canopy mounts fan or fixture to system. Adaptable to switch control. For use with (20). Shipping weight 1 lb. 8 oz. 9 R 81243—Ea. \$11.99 2 or more—Ea. \$9.59

**15** Traks plug into other traks or to modules to extend system. Brackets mount trak.

Ft.	Catalog Number	Wt. ea.		Ea.	2 or more, ea.
		lb.	oz.		
1	9 R 81244	7		\$4.99	\$3.99
2	9 R 81245	13		6.99	5.59
3	9 R 81246	1	4	8.99	7.19
4	9 R 81247	1	10	9.99	7.99

**16** Plug-in starter connector plugs into any grounded outlet to bring power to traks or modules. Wt. 7 oz. 9 R 81249 . . . Ea. \$6.99 2 or more . . . Ea. \$5.59

**17** Wire-in starter connector wires to any grounded outlet box; swivels in any direction to start system. Shpg. wt. 14 oz. 9 R 81251 . . . Ea. \$6.99 2 or more . . . Ea. \$5.59

**18** Flexible corner connector turns any corner, plugs into all traks or modules. Wt. 5 oz. 9 R 81252 . . . Ea. \$6.99 2 or more . . . Ea. \$5.59

**19** Telescoping trak adjusts to any length between 2 and 3-ft. for exact fit. Shpg. wt. 1 lb. 4 oz. 9 R 81248 . . . Ea. \$9.99 2 or more . . . Ea. \$7.99

**20** Fan/fixture connector adapts trak to canopy with 3/8-in. side hole. Wt. 3 oz. 9 R 81253—Ea. \$6.99 2 or more . . . Ea. \$5.59

**21** Heavy duty hanger kit for direct mounting to ceiling joist. Use with (14). Shpg. wt. 5 oz. 9 R 81254 . . . Ea. \$4.99 2 or more . . . Ea. \$3.99

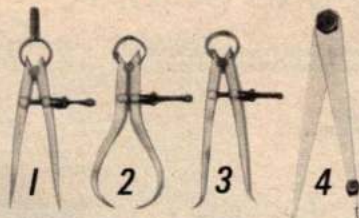

### Callipers and dividers

1 thru 4 Flat adjustable legs of tool steel.\*

Item	Size	Catalog Number	Wt.	Price
(1) Dividers	4 in.	9 R 38591	2	\$7.99
	6 in.	9 R 38592	4	9.99
	12 in.	9 R 38594	7	17.99
(2) Outside Calipers	4 in.	9 R 38598	2	7.99
	6 in.	9 R 38599	4	9.99
	12 in.	9 R 38596	8	17.99
(3) Inside Calipers	4 in.	9 R 38593	2	7.99
	6 in.	9 R 38597	3	9.99
	12 in.	9 R 38595	7	17.99

4 Available in Catalog only.  
Hermaphrodite caliper is shaped for marking out and scribing lines parallel to edge, finding centers of round stock. Firm joint allows for quick, positive adjustment. 6-inch size.\*  
9 R 38537—Shpg. wt. 3 oz. . . \$9.99



5 Machinists' steel squares are hardened, ground. No graduations. Imported.\*

Blade in.	Beam in.	Catalog Number	Wt.	Price
2 9/16	1 3/4	9 R 40401	2 oz.	\$9.99
3 1/8	2 1/4	9 R 40402	4 oz.	10.99
4	3	9 R 40403	6 oz.	11.99
6	3 3/4	9 R 40404	11 oz.	12.99



6 Set holds up to 1-in. round or irregular shaped material. Two tool steel V-blocks are precision-ground for square and parallel accuracy. 2 clamps incl.\*  
9 R 4083—Wt. 1 lb. 9 oz. . . \$29.99

7 Adjustable trammel points measure distances too great for ordinary dividers. 3-in. points and fine adj. screw.\*  
9 R 4061—Shpg. wt. 7 oz. . . \$19.99

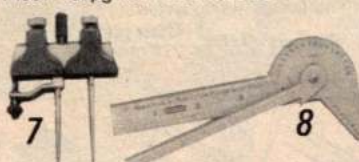

8 Multi-purpose rule and gauge functions as a square, protractor, drill gauge, center finder.\*  
9 R 4026—Shpg. wt. 1 oz. . . \$5.99

Depth gauge (not shown) has 2 1/2-in. head graduated at 30°, 45° and 60°. 6x7/32-in. rule is marked in 32nds and 64ths. Tensioned slide lock.\*  
9 R 40442—Shpg. wt. 2 oz. . . \$9.99

Protractor (not shown) has rectangular head. Scale is double-graduated from 0° to 180°. Adjustable spring tension holds setting.\*  
9 R 4029—Shpg. wt. 3 oz. . . \$8.99

64

Here and on the next 3 pages . . . **PRECISION TOOLS** designed for engineers, machinists, quality controllers . . . anyone who demands the most accurate readings possible

### CRAFTSMAN® Combination Square Sets have cast-iron heads, inch and metric readings

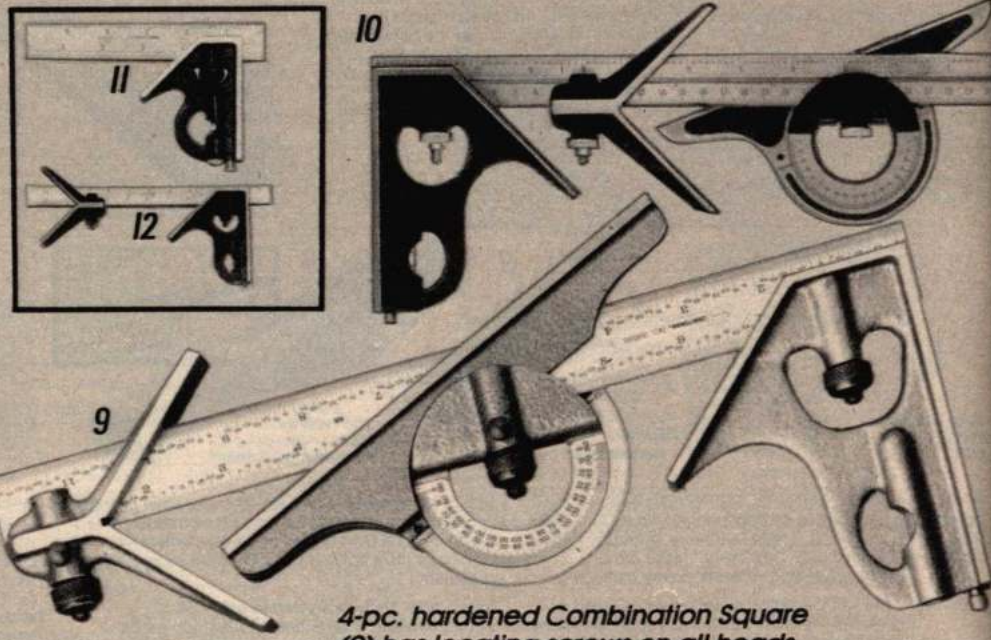

9 Available in Catalog only.  
Machinists' Combination Square with locating device positions heads for quick assembly. Cast-iron square, center and protractor heads. Center, square heads fully hardened to 55 Rc. Level vial on square and protractor heads. Satin chrome hardened, tempered blade is 12 in. long. Finely etched graduations (64ths front, 8ths, 16ths back). Reversible protractor head graduated 180° left, right. Includes scriber. Meets Federal Specs. GGG-S-656C. Type IV, Class A.\*  
9 R 38698—Wt. 1 lb. 10 oz. \$94.99

4-pc. hardened Combination Square (9) has locating screws on all heads

10 thru 12 Machinists' combination squares have steel scale, photo-engraved for accuracy. Cast-iron precision-ground protractor, square head, center head. Level vials. Chrome-plated blade. Back graduations in 32nds, 64ths in. Non-reversible bevel protractor graduated 180°. Meets Fed. Spec. GGG-S-656a.\*

Scale in.	Front graduations	Catalog Number	Wt. lbs. oz.	Price
12	8ths, 16ths in.	9 R 38694	1 6	\$62.99
12	1 mm., 0.5 mm.	9 R 38643	2 4	67.99
12	50ths, 100ths in.	9 R 38695	2 4	64.99

Scale in.	Front graduations	Catalog Number	Wt. lbs. oz.	Price
6	8ths, 16ths in.	9 R 3869	1 9	\$26.99
12	8ths, 16ths in.	9 R 38691	1 4	29.99
12	8ths, 16ths in.	9 R 38693	1 10	\$39.99

12-in. Replacement blade for squares 9-38691, 9-38693, 9-38694. Silver-mist color chrome-plated finish.\*  
9 R 38699—Wt. 4 oz. . . \$14.99  
\*Warranted by Sears. Write for free copy, see p. 148.

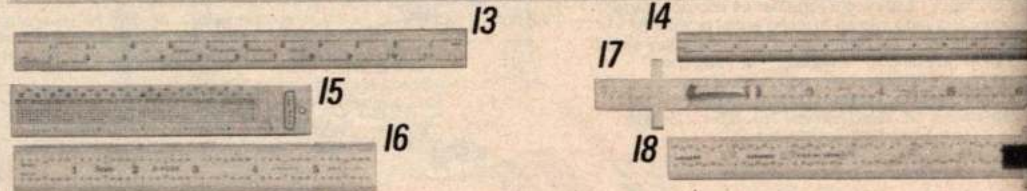

### Measuring Rules for all requirements

13 Available in Catalog only.  
CRAFTSMAN satin-chrome finished tempered steel rules are graduated in 10ths, 100ths, 32nds and 64ths. Meets Federal Specification GGG-R-791f for accuracy.\*

Length	Catalog No.	Shpg. wt.	Price
6-in.	9 R 40303	6 oz.	\$4.99
12-in.	9 R 40304	1 lb. 8 oz.	7.99
18-in.	9 R 40305	12 oz.	13.99
24-in.	9 R 40306	1 lb.	19.99

14 Center finding rule finds exact center without the need of calculations. 12 in. long. Stainless steel. Graduated 16th, 32nds front; 32nds, 64ths back.  
9 R 40992—Shpg. wt. 2 oz. . . \$4.99

15 Quick-reading 6-in. reference table rule has decimal equivalents, tap and drill data.\*  
9 R 4011—Shpg. wt. 1 oz. . . \$3.49

16 CRAFTSMAN satin chrome-plated steel rules.\*

Size, inches	Graduations, in inches		Type	Catalog Number	Wt. oz.	Price
	Front	Back				
6x1/2	1/16, 1/32	1/32, 1/64	flex.	9 R 40996	1	\$3.49
6x1/2	1/16, 1/32	1/32, 1/64	flex.	9 R 4015	1	2.49
6x1/2	1/16, 1/32	1/32, 1/64	rigid	9 R 40136	3	4.49
12x1	1/32, 1/64	1, 0.5mm	rigid	9 R 40991	2	9.99

17 Flexible stainless steel rule. 6x1/2 in. Front 1/16, 1/32; back decimal equivalent. Pocket clip.\*  
9 R 4030—Shpg. wt. 1 oz. . . \$1.49

6x1/2-in. Rule has 1/16-in., 1-mm graduations on front, metric chart back.  
9 R 40131—Shpg. wt. 1 oz. . . \$1.99  
6x3/4 in. No clip. Front 1/32, 1/64. Back as above.  
9 R 4006—Shpg. wt. 1 oz. . . \$1.99

18 Available in Catalog only.  
CRAFTSMAN 6-in. rigid rule with hook to measure steps, etc. Graduations: Front—1/32, 1/64 in.; back—1/16, 1/8 in. Satin chrome-plated.\*  
9 R 40302—Shpg. wt. 1 oz. . . \$10.99

Powerful Magnetic Holders put a rock-steady grip on indicators, gauges and accessories to give you sure, accurate readings

1 Our 90-lb. Indicator Holder adjusts within .0005 in.!

- ✓ No-residual magnetism to attract small chips, filings
- ✓ Holds all types of indicators to AGD specs.
- ✓ Fine, multiple adjustments for any angle
- ✓ Positive on/off with automatic shut off

\$49<sup>99</sup>

Holder has flexible arm

\$49<sup>99</sup>

Item (4) \$42<sup>99</sup>

1 Available in Catalog only. Indicator holder has precision-ground steel base. 2x3½x3¼ in. high.\* 9 R 38913—Wt. 2 lbs. 14 oz. . . \$49.99

2 Holder with 150-lb. pull holds all types of indicators (incl. AGD). Maximum reach is 15¼ in. Base is 2x2½x2¼ in. high.\* 9 R 38912—Wt. 3 lbs. 8 oz. . . \$49.99

3 Holder with 150-lb. pull holds dial indicators with ½-in. holder, fine adjustment. Steel magnetic base has on/off lever. 3½x2x2¼ in. high.\* 9 R 38908—Wt. 3 lbs. 5 oz. . . \$39.99

4 Available in Catalog only. Holder with 150-lb. pull holds all indicators (incl. AGD). 2x2½x2¼-in. high base. in. high overall.\* 9 R 38911—Wt. 3 lbs. 6 oz. . . \$42.99

5 Holder with 50-lb. pull holds dial indicators with ¼ in. holder. Steel. Quick release lever. 3½x1¼x2 in. high. 6 in. high overall.\* 9 R 3872—Wt. 12 oz. . . \$19.99

6 Available in Catalog only. Holder with 60-lb. pull holds most dial indicators: center lug, universal or plunger back. Magnetic base has quick release lever. Steel. 3½x2x2½ in. high. 9 in. H. overall.\* 9 R 38677—Wt. 1 lb. 6 oz. . . \$29.99

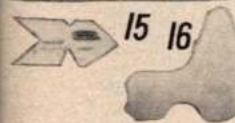

14 Drill gauge, measures 29 sizes from 1/16 to 1/2. Steel.\* 9 R 4049—Wt. ea. 4 oz. . . \$7.99

15 Available in Catalog only. Center gauge is graduated at 14ths, 20ths, 24ths, and 32nds in U.S. Standard 60 thread form. Chrome-plated steel.\* 9 R 40642—Wt. ea. 1 oz. . . \$4.99

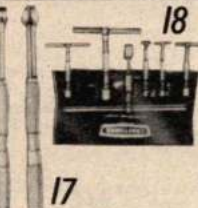

16 Available in Catalog only. 25-pc. radius or fillet gauge set has corresponding external and internal forms. Incl. 16 gauges (1/32 to 1 7/16 by 64ths), 8 gauges (1/32 to 1/2 by 32ths), 4-in. gauge holder, case. Meets Fed Specs. GGG-G-17a Type VII. Stainless steel.\* Wt. ea. 12 oz. 9 R 40952. . . Set \$44.99

17 4-pc. small-hole gauge set has range of 1/8 to 1/2-in. Locks. Imp. Chrome-plated tool steel.\* Plastic pouch. 9 R 40561—Wt. ea. 4 oz. . . Set \$34.99



CRAFTSMAN® Gauge Sets

18 Tool steel telescope gauge set has hardened, ground measuring faces. Plunger telescopes, locks with knurled screw.\* Incl. plastic pouch. 6-pc. gauge set. Range: 5/16 to 6 in. 9 R 4027—Wt. ea. 11 oz. . . Set \$69.99

4-pc. gauge set. Range: 5/16 to 2 1/2 in. 9 R 40203—Wt. ea. 4 oz. . . Set \$29.99

19 Screw-pitch gauge pitches 4 to 84. Has 51 gauges, 60 degree, V-thread. Steel.\* 9 R 4031—Wt. ea. 3 oz. . . \$19.99



20 Circular gauge measures non-ferrous wire, sheet and plate sizes 0 to 36. American Standard. Chrome-plated steel.\* 9 R 4023—Wt. ea. 3 oz. . . \$12.49

21 Thickness gauge has 26 leaves from .0015 to .025 in. thick. Taper to 1/4-in. Steel.\* 9 R 4094—Wt. ea. 3 oz. . . \$11.99

22 Pocket thickness gauge measures different materials thru consistent spindle pressure. Reads 0-100 by .001-in. Ground and lapped.\* 9 R 4615—Wt. ea. 3 oz. . . \$59.99

CRAFTSMAN Dial Testing Equipment

7 Available in Catalog only. Dial bore gauge set. Dial reads by .0001 in. Bore diam. range 2.0 to 6.0 in. 6-in. bore depth. Adjustable tolerance pointers. Incl. dial bore gauge, 10 extensions (2 to 4 in.) 2-in. extension collar, 2 carbide contact points, case. Imported.\* 9 R 38678—Wt. 2 lbs. 5 oz. . . \$159.99

8 Available in Catalog only. 0-50-0 universal dial test indicator set has range of .200 in. x .001 in. graduations. Incl. clamp, tool post holder, 2 holding rods and case.\* 9 R 38679—Wt. 2 lbs. 2 oz. . . \$89.99

9 Available in Catalog only. 0-10-0 universal dial test set has range of .020 in. x .0005 in. Incl. 3 contact points, 2 stems (1/4, 3/8 in.), universal holder and clamp with dovetail slots, automatic reversal contact point, case. Imported.\* 9 R 40755—Wt. 8 oz. . . \$64.99

10 Available in Catalog only. 0-50-0 plunger dial test indicator set reads by .001 in. marked "+" and "-" for left/right reading. Range .200 in. (2 revolutions). Back plunger gauge with 1 1/2 in. diam. dial. Includes universal clamp, tool post holder, C-clamp, hole lever attachment, 3 contact points, 2 extension arms and storage case.\* 9 R 38675—Wt. 1 lb. 12 oz. . . \$49.99

0-50-0 dial indicator with hole attachment. Same as (10) above. 9 R 38676—Wt. 7 oz. . . \$34.99

11 Available in Catalog only. 0-1 plunger dial indicator with revolution accumulator. 1,000 in. range by .001 in. 2 in. diam. dial. Lug back. Imported.\* 9 R 38674—Wt. 8 oz. . . \$34.99

12 Available in Catalog only. Indicator with 2 1/4 in. rotating dial reads 0-100 by .001 in. 1 inch travel revolution accumulations counter. 2-way readings. Lug back attachment. Meets AGD specs.\* 9 R 38671—Wt. 8 oz. . . \$29.99

13 Timing gauge set reads 0-100 by .001 in. Stainless steel stem, spindle back. Brass casing. Adjustable tolerance pointers. 1-in. travel indicator with 1-in. contact point extension. 14 and 18mm spark plug hole adapters. Universal lug back. Adj. dial face, bezel lock. Meets AGD specs.\* 9 R 38672—Shpg. wt. 13 oz. . . \$64.99

\*Warranted by manufacturer. Write for free copy, see page 148.

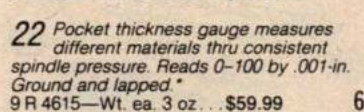
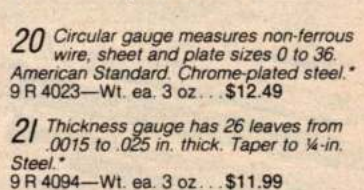
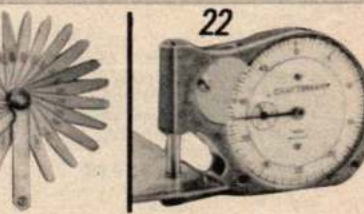
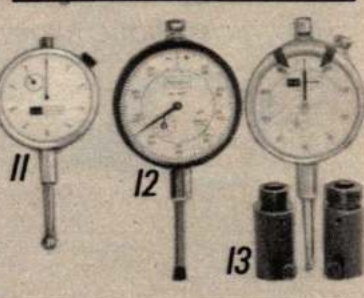
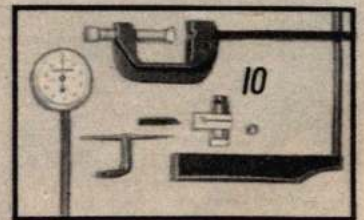
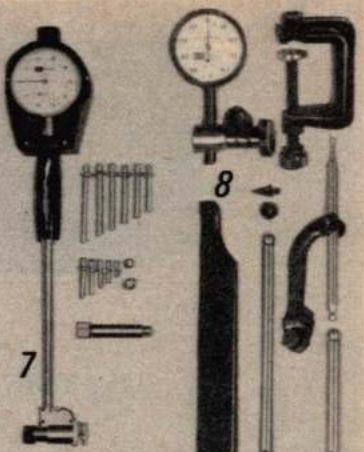



### Electronic Digital Caliper

- Direct readout ends guesswork and complicated conversions
- Sealed electronics minimize interference caused by dust or oil
- Floating zero for checking deviations
- Pushbutton inch/metric conversions

Digital caliper has four modes: measurement, limit, peak and data (interface required for computer hookup, printer needed for data output). Accurate to  $\pm .001$  in. or  $\pm .025$ mm. Range: 0 to 6 in., 0 to 155mm. Auto shutoff. Display memory holds readings. Frame, jaws and depth rod are precision-ground stainless steel. Battery, case, instr. incl. Imported.  
9 R 38754—Wt. 12 oz... \$147.88

\$147.88

### CRAFTSMAN® Stainless steel Dial Calipers \$69.99 and up

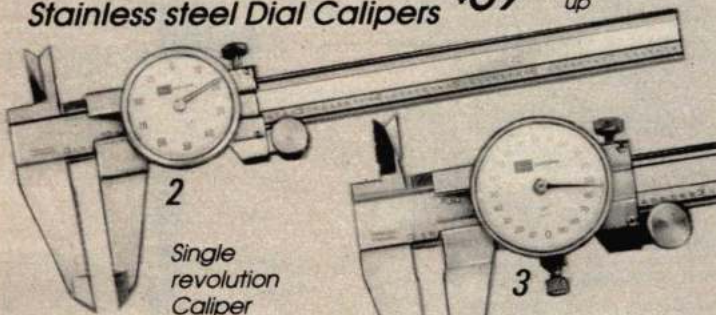

2 Single revolution Caliper

3 Caliper with chrome-plated scales on beam

2 Single-revolution dial calipers have .100-in. direct reading per revolution, .001-in. graduations. Accurate to  $\pm .001$ -in. 4-way measurement capability. Covered rack. Dual-gear movement floats over internal obstructions. Precision-ground, lapped. Satin-chrome finish. Incl. case.

3 Depth gauge. Inside/outside scales. Depth, step measurements, adj. bezel with lock.

Range inches	Catalog Number	Wt.		Price
		lb.	oz.	
0-12	9 R 40186	1	12	\$159.99
0-8	9 R 40188	1	7	119.99
0-6	9 R 40185	1	...	69.99

Range: 0-6-in. by .001-in.  
9 R 40172—Shpg. wt. 14 oz... \$59.99  
Range: 0-4-in. by .001-in.  
9 R 40173—Shpg. wt. 12 oz... \$54.99

### Fiberglass Dial Calipers \$12.99 and up

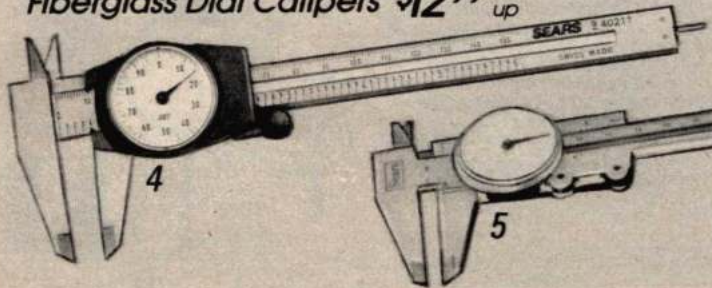

4

5

4 Sears 0-6 in. capacity caliper reads in .001 in. on dial in single revolution, 1.0mm on bar scale. 4-way inside, outside, depth and step measurements. Friction roller. Imported. Not Craftsman.  
9 R 40211—Wt. 8 oz... \$19.99

5 Sears inch/metric dial, vernier caliper has 0-5-in./130mm range. 4-way readings: decimal, fractional on dial, metric on vernier scale. Measures step. Zero adjustment. Thumb roll. Inch scale: .01-in., 1/64 in. Metric: 0.1mm. Fiberglass. Imported. Not Craftsman.  
9 R 4021—Shpg. wt. 6 oz... \$12.99

### Stainless steel Vernier Calipers



6

\$29.99

6 CRAFTSMAN inch/metric vernier caliper with 6-in./150mm range. 0 to 6-in. by .001-in./0 to 150mm by .05mm. Thumb lock.  
9 R 40181—Shpg. wt. 7 oz... \$29.99



\$19.99

7 CRAFTSMAN inch/metric vernier caliper with 0.5-in./130mm range. 3 way readings. Reads to .001-in./0.05mm. Stainless steel, polished scales, precision-ground faces. Imported.  
9 R 40257—Wt. 6 oz... \$19.99



8

\$9.99

8 General purpose caliper has 5-in. cap., graduated to 1/16 in./1mm. Thumb roller and slide lock. Not Craftsman.  
9 R 40212—Wt. 1 oz... \$9.99



9

\$7.99

9 Sears inch, inch/metric vernier calipers. Depth rod. Roller adj. Polished steel. 5-in./125mm cap. Vernier to 1/32-in. and 0.1mm. Not Craftsman.  
Inch Scale: 16ths, 32nds grad. 9 R 4022—Wt. 3 oz... \$7.99  
Inch/metric Scale: 16ths in., 1mm. 9 R 40222—Wt. 4 oz... \$7.99



10

\$4.88

10 Sears pocket inch/metric caliper reads to 3/16 in., inside to 3-in. Scale to 32nds, 1.0mm. Stainless steel. Not Craftsman.  
9 R 4025—Wt. 2 oz... \$4.88

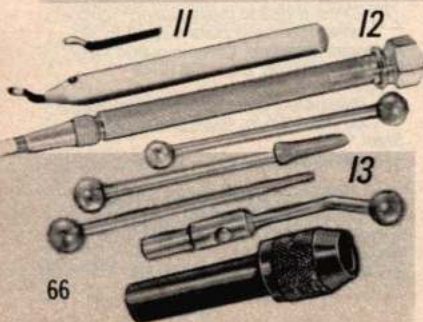

11

12

13

11 Deburring tool is precision-made with swivel head and push-button release. Includes 2 blades.  
9 R 4079—Shpg. wt. 2 oz... \$4.99  
9 R 40791—Repl. blades. Wt. 1 oz. \$2.99

12 Pocket scribers have knurled steel body and replaceable nickel-plated steel points. Point reverses for safety.  
9 R 4051—1/4 in. diam. Wt. 3 oz... \$1.99  
9 R 40513—3/8 in. diam. Wt. 4 oz. \$2.99

5-power eye loupe magnifier.  
9 R 40877—Shpg. wt. 1 oz... \$2.99

13 5-piece center-finding wiggler set helps you find the center and working positions on drill presses, milling machines, etc. Tool set has interchangeable offset, needle, disc and ball joints. Ball-and-swivel joint clamps into chuck. 4 1/2 in. long.  
9 R 4004—Wt. 3 oz... Set \$12.99  
CRAFTSMAN scriber (not shown) engraves glass, china, ceramics, steel. Tip reverses for safety. Magnetic end retrieves small parts.  
9 R 4078—Wt. 1 oz... \$3.99

CRAFTSMAN double-point scriber (not shown) has interchangeable point: 9 in. with short points, 12 in. with long points.  
9 R 4014—Wt. 1 oz... \$2.49

1/2-in. diameter single-edge finder (not shown). Hardened tool steel is centerless and ground to precision tolerance.  
9 R 38819—Wt. 2 oz... \$6.99

Pin vise (not shown). 2 double-reversible checks. 0 to .125-in. capacity (0 to 3.2mm).  
9 R 40682—Wt. 1 oz... \$3.99

For over 60 years because our industry-quality Calipers and Micrometers meet strict specifications for accuracy, and we fully warrant them for 1 year\*



Steel frame. Satin chrome-plated head. Includes 3 standards, wrench, case. Range 0 to 4 in. 9 R 38607—Wt. 2 lbs. 15 oz. . . \$97.88



**CRAFTSMAN®**  
Digital Micrometer with heat insulating pads gives extremely accurate readings

- Easy thumb-button operation with automatic shutoff
- Direct readings eliminate complicated conversions
- Sealed electronics reduce interference from dust particles, oil
- Vernier scale accurate to  $\pm .0001$  inches
- Available IN CATALOG ONLY!

**\$79.99** and up

2 Inch digital micrometer has hammer finished frame with carbide-tipped anvil and spindle. Spindle hardened to Rc 60-61. Counter has metal gears. Easy zero adjustment. Thumb lock, ratchet stop. Case Imported.

Range inch	No. of Stds.	Catalog Number	Shpg. wt.		Price
			lb.	oz.	
0-1	0	9 R 38667	11	11	\$79.99
1-2	1	9 R 38731	12	12	97.88
2-3	1	9 R 38732	13	13	114.99
3-4	1	9 R 38733	1	1	134.99

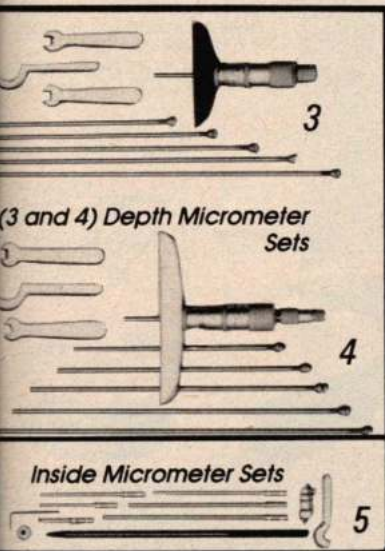

3 Depth micrometer sets have ends hardened, precision-ground, lapped. Screw stock extensions. Adj. sleeve. 2½-in. long base micro-lapped to 4 RMS. Doublelock nut system. To .001-in./01 mm.

Range in.	Catalog Number	Wt.		Price set
		lbs.	oz.	
0-6	9 R 38632	1	15	\$81.88
0-3	9 R 3863	1	6	74.99
0-75mm	9 R 38623	1	6	74.99

4 Depth micrometer set with 4-in. base. 0-6-in. range by .001-in. Adj. sleeve, lock, ratchet stop. 9 R 3865—Wt. 2 lbs. 5 oz. . . Set \$97.88

5 Inside micrometer sets with ground, hardened heads and mandrels. Satin-chrome-plated. Setting wrench, extension handle. Reads to .001-in. Case.

Range in.	Catalog Number	Wt.		Price set
		lbs.	oz.	
1¼-8½	9 R 3864	1	9	\$74.99
1½-12½	9 R 38641	2	9	89.99

\*See warranty, page 148.



(6 and 7) Carbide-tipped Micrometers give years of accurate service **\$43.88** and up

Machinists Micrometers have precision ground threads **\$37.88** and up

Rolled thread Micrometers for rugged industrial or automotive uses **\$27.88** and up

Apprentice Micrometers are ideal for students or home workshop **\$8.88** and up

6 Satin-finish micrometer has carbide-tipped anvil, spindle. Ground and polished threads. Drop-forged steel frame. Graduated to .0001-in. Incl. plastic pouch.

0 to 1-in. range. Wt. 6 oz. 9 R 38662 . . . \$47.88

7 Carbide-tipped micrometers with black wrinkle finish. Drop-forged steel frame, satin-chrome plated barrel, spindle, spindle lock, ratchet stop. Spindle hardened to Rc 62-64 with lead error held to .00005 in. Reads to .0001-in. on vernier scale. Adjusting wrench, pouch, manual.

0 to 1-in. range. 9 R 38631—Wt. 7 oz. . . \$43.88  
1 to 2-in. range. One setting std. 9 R 38633—Wt. 9 oz. . . \$59.99

\$12 MONTHLY, see p. 148. Carbide-tipped Micrometer set with 0 to 4-in. range. Contains 0 to 1, 1 to 2, 2 to 3, 3 to 4-in. micrometers with 1, 2, 3-in. standards. Case included. 9 R 38635—Wt. 4 lbs. 8 oz. . . \$249.99

8 Machinists' Precision Ground-thread micrometers have drop-forged steel frame, polished spindle, anvil. Spindle hardened to Rc 62-64. Lead error held to  $\pm .00005$  in. Marked to .001-in.

Range in.	No. of Stds.	Catalog Number	Wt.		Price
			lbs.	oz.	
0-1	0	9 R 38601	6	6	\$37.88
1-2	1	9 R 38602	8	8	49.99
2-3	1	9 R 38603	10	10	54.99
3-4	1	9 R 38604	14	14	59.99
4-5	1	9 R 38605	1	2	69.99
5-6	1	9 R 38606	1	6	79.99

Machinists' Precision Ground-thread Micrometer Sets incl. case, manual. 4-pc. set has 0-4-in. range. 3 stds. F 9 R 3860—Wt. 4 lbs. 5 oz. . . \$199.99  
Left-hand micrometer similar to (9) at right. 9 R 38729—Wt. 7 oz. . . \$49.99  
• Sent from factory. Allow extra time. Shipping and handling charged from Cat. Mdse. Dist. Ctr. No C.O.D. orders.

9 Rolled thread micrometers have spindle hardened to Rc 58-62 with lead error held to  $\pm .0003$  in. Reads to .001-in. Forged steel frame with polished spindle, anvil. Adj. wrench.

Range in.	Pcs.	Stds.	Catalog Number	Wt.		Price
				lbs.	oz.	
0-1	1	0	9 R 38624	6	6	\$27.88
1-2	1	1	9 R 38625	7	7	34.99
2-3	1	1	9 R 38626	8	8	39.99
3-4	1	1	9 R 38627	13	13	44.99
4-5	1	1	9 R 38628	1	1	49.99
5-6	1	1	9 R 38629	1	3	54.99
0-4	4	3	9 R 38613	2	10	149.99

10 Apprentice micrometers have rolled threads. Friction stop. .001-in. graduations. Incl. wrench, instr. Not Craftsman.

Range inch	Stds.	Catalog Number	Wt.	Price
0-1	0	9 R 40707	6 oz.	\$8.88
1-2	1	9 R 40708	8 oz.	12.99
2-3	1	9 R 40709	10 oz.	17.99

Apprentice micrometer set includes all 3 listed above, fitted case. 9 R 40716—Wt. 1 lb. 10 oz. . . \$39.99

**Surveyors, Farmers, Landscapers, Excavators, Builders, Contractors, Engineers . . . see how our durable CRAFTSMAN Transits and Levels combine features for quickness and accuracy into a tool that's just right for your needs. Available in catalog only!**

Builders' and Contractors' Transit Kit includes heavy-duty Transit Level with scope vial sensitivity of 7 to 8 minutes per 2mm division, 9-ft. maple builders' rod, metal folding tripod and case

**\$218<sup>88</sup>** <sup>9/11</sup> MONTHLY, see p. 148

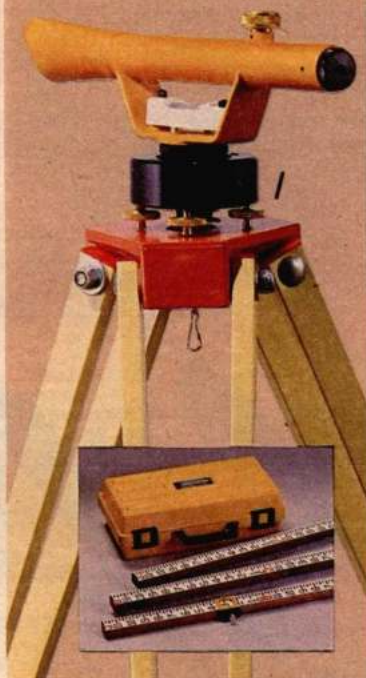

Builders' and Contractors' Transit has scope that fully transits for front and back sites. Precision scope vial has sensitivity of 60 seconds per 2mm division

**\$849<sup>99</sup>** <sup>12/9</sup> MONTHLY, see p. 148



High-powered 26X Telescope converts instantly from tilting to level. 2 level vials give maximum level control with easy to use lock

**\$549<sup>99</sup>** <sup>11/9</sup> MONTHLY, see p. 148



Contractors' Automatic Level self-levels after quick "rough" setup. Immediately lets you work faster with more accuracy with the high powered 28X telescope

**\$649<sup>99</sup>** <sup>12/22</sup> MONTHLY, see p. 148



Heavy-duty Contractors' Transit-Level has scope vial sensitivity of 4 1/2 min. per 2mm div.

**\$439<sup>99</sup>** <sup>11/6</sup> MONTHLY, see p. 148



**Builders' and Farmers' Automatic Level is our easiest to use. After a simple setup, a special wire-hung compensator keeps it level**

- 20-power telescope is precision set for accuracy
- Unique lever clamp has fine motion tangent screw clamp, tangent screws, circle and index
- Rack and pinion focusing gives precise image control

**\$439<sup>99</sup>** <sup>11/6</sup> MONTHLY, see p. 148

FULL ONE YEAR WARRANTY ON CRAFTSMAN, SEARS TRANSIT AND SIGHTING LEVELS AND CRAFTSMAN PRECISION TOOLS. If within one year of purchase, any of these items fail due to defect in material or workmanship, Sears will repair it, free of charge. Warranty service is available by returning instrument to nearest Sears store in U.S. This warranty gives you specific legal rights and you may also have other rights which vary from state to state.

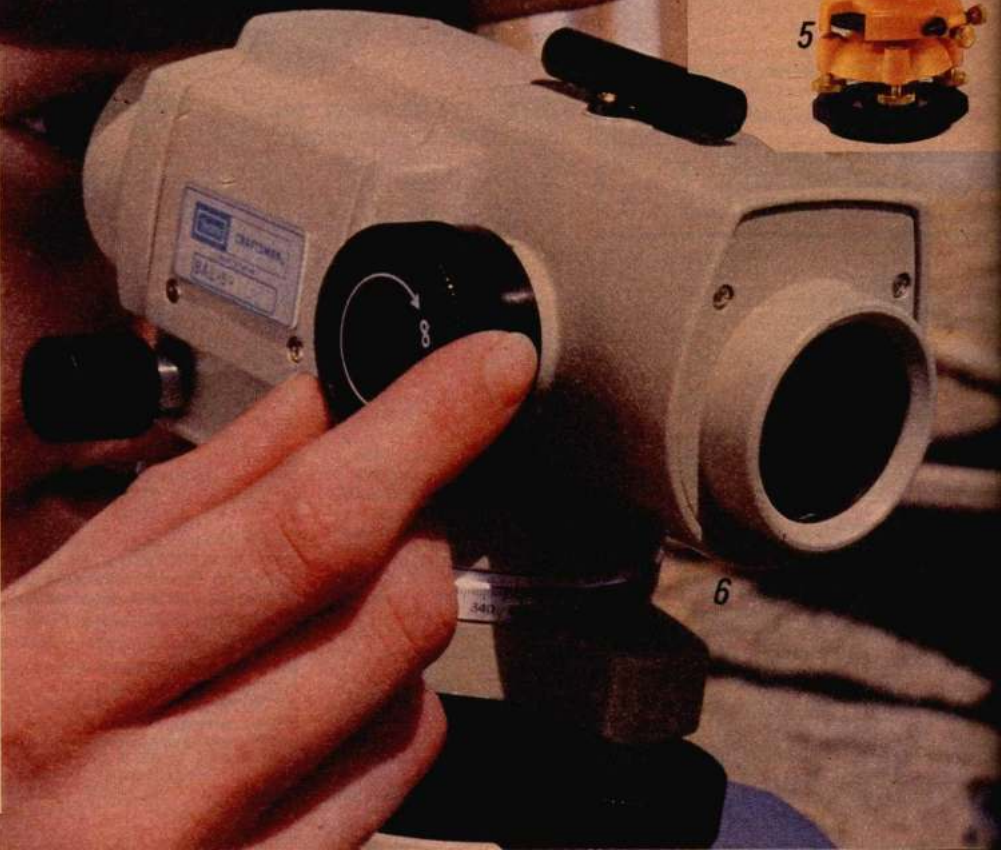

20X Transit Level has scope vial sensitivity of 7 to 8 min. per 2mm division

**\$319<sup>99</sup>**

\$13 MONTHLY, see p. 148

Sears Economy Level has scope vial sensitivity of 9 to 11 min. per 2mm div.

**\$139<sup>99</sup>**

\$10 MONTHLY, see p. 148

Compact Builder's Dumpy Level has scope vial sensitivity of 7 to 8 min. per 2mm division

**\$219<sup>99</sup>**

\$11 MONTHLY, see p. 148

10 Pocket Sight and Surface Level for leveling, grading or as surface level. 5 1/2 in. long. Aluminum.

9 R 4624—Shpg. wt. 13 oz. ... **\$24.99**

11 Magnifying Locke-type Hand Level for rough surveying. 2 1/2 power. Brass with aluminum caps. 6 1/2 in. long. 9 R 4608—Shpg. wt. 7 oz. ... **\$59.99**

12 Open Reel Measuring Tape of nylon-clad steel has 1/16-ft. gradations. Not Craftsman.

Catalog Number	Length ft.	Shpg. wt.		Price
		lbs.	oz.	
9 R 46087	100	1	4	\$49.99
9 R 46097	200	3	4	79.99

13 Solid Brass Plumb Bob meets Govt. Spec. GGG-P-501E. 16 oz. 5 1/4-in. 9 R 4614—Wt. 1 lb. 2 oz. ... **\$16.99**

14 Leather Sheath fits (13). 18-oz. bobs. Adj. snaps. 9 R 46162—Shpg. wt. 2 oz. ... **\$4.99**

15 Wide-frame Tripods provide max. stability. Metal legs, hardware. Yellow with orange accent marks. Binding strap. Shifting type fastener w/1/2x20-in. thread. Fits (7, 8, 9).

Catalog Number	Shpg. wt.	Tripod alone	With transit
Stiff leg for flat terrain			
9 R 46086C	10 lbs.	\$79.99	\$69.99
Extension leg for uneven terrain			
9 R 46088C	11 lbs.	\$99.99	\$89.99

16 Solid maple Engineers' Rod has white face marked in ft., 1/16-ft., 1/100-ft. Snap-on vernier target reads to 1/1000-ft. 9 R 46123C—10-ft. Wt. 7 lbs. ... **\$74.99**

9 R 46124C—15-ft. Wt. 9 lbs. ... **\$89.99**

17 Sliding-type Builders' Rod similar to (16) but marked in ft., in., 1/8-in. Snap-on vernier target marked 1/8-in. 9 R 46125C—10-ft. Wt. 7 lbs. ... **\$69.99**

9 R 46126C—15-ft. Wt. 9 lbs. ... **\$89.99**

18 Pocket rod is combination builders' rod and surveyor's pole. Graduated on both sides. Nylon-coated steel blade. 6 1/2-ft. long. Built-in target. Not Craftsman.

Inch. foot graduations  
9 R 46017—Wt. 5 oz. ... **\$12.99**

1/16-ft. graduations  
9 R 46007—Wt. 5 oz. ... **\$12.99**

19 Heavy-duty wide frame aluminum extension Tripod with 3/8x11-in. thread. Fits current (4, 6), 46029 (underlist of 2), past (46028, 4611, 46116). Wt. 13 lbs. 9 R 46094C ... Tripod alone **\$139.99**

Price when you also buy transit ... **\$129.99**

Alum. extension Tripod with 3/8x8-in. thread. Fits (2, 3, 5). Wt. 13 lbs. 9 R 46094C ... Tripod alone **\$149.99**

Price when you also buy transit ... **\$139.99**

Standard wide frame. Tripod of wood and aluminum. 3/2"x8-in. thread. Fits (2, 3, 5).

Catalog Number	Shpg. wt.	Tripod alone	With transit
Stiff leg for flat terrain			
9 R 46102L	10 lbs.	\$99.99	\$89.99
Extension leg for uneven terrain			
9 R 46095C	12 lbs.	\$119.99	\$109.99

thru 9 Our Transits and Levels help you work quickly and accurately with large circles and verniers that speed readings. Precise, easy-to-read gradations are permanently registered on metal. Dust-protected leveling screws with large knobs make handling easier. Obtain accurate sightings with telescopes which are precision-bored to close tolerances, dust-proof fittings. Lenses are polished to exact curves.

Color-corrected lens system. Rack-and-pinion focusing, distinct crosshairs. Erect images. Precision-machined fine-motion parts eliminate backlash, sideplay. Hard-baked finishes for high visibility, abrasion-resistance. (2, 3) have removable sunshade. Includes high-impact carrying case, (2, 3, 4 and 8) have foam lined case. Plumb bob with string, instructions. See specifications chart below. Service information below. Warranted by Sears, see facing page.

Level Telescope Magnification	Short Focus	Sensitivity for 2mm division		Readings: H=Horiz. V=Vert.	Leveling Head Construction	Accessories	Catalog Number	Shpg. wt.		Price
		Telescope vial	Plate vial					lbs.	oz.	
(1) 20 power	4.5 ft.	7 to 8 min.	12 to 14 min.	H=15 min. V=60 min.	Aircraft alloy, 4 leveling screw base, bronze center disc. Accepts 1/2x20 tripod mounting fastener. Alum. circle, vernier	pin wrench	9 R 46265	4	6	\$218.88
(2) 24 power	4 ft.	60 seconds	120 seconds	H=1 min. (1/8) V=1 min. (1/8)	4 leveling screw base. Bronze 3/8x8 in. thread. Built-in compass machined, fitted bronze center	Adj. pin, wrench magnifying glass, brush, screwdriver	9 R 4617	12		849.99
(3) 24 power	3 ft.	110 seconds	130 seconds	H=5 min. (1/2) V=5 min. (1/2)	Ball bearing spindle, 4 level screw base, 3/8x8 in. thread. U.S. Gov't. Std. footplate. Brass micrometer type clamp, tangent screws. Alum. circle and vernier.	pin wrench	9 R 46178C	19	4	549.99
18 to 34 power (not shown)	3 ft.	110 seconds	130 seconds	H=5 min. (1/2) V=5 min. (1/2)	Brass circle, vernier. Built-in optical plummet, 1/2x11 in. threaded base. Zoom lens.	Adj. pin, wrench, magnifying glass, brush, screwdriver	9 R 46029C	11		749.99
(4) 28 power	3.9 ft.		10 minutes circular vial	H=60 min. (1)	3 leveling screw base. 1/2x11 in. threaded footplate base. Micrometer type clamp, tangent screws, circle, index.	Adj. pin, screwdriver	9 R 4612C	10		649.99
(5) 20 power	4.5 ft.	4 1/2 min.	12 to 14 min.	H=5 min. (1/2) V=60 min. (1)	Same as (3)	Same as (3)	9 R 46238	9		439.99
(6) 20 power	2.9 ft.		10 minutes circular vial	H=60 min. (1)	3 leveling screw base. 1/2x11 in. thread footplate base.	Adj. pin, screwdriver	9 R 46173	5		439.99
(7) 20 power	4.5 ft.	7 to 8 min.	12 to 14 min.	H=15 min. (1/4) V=60 min. (1)	Aircraft alloy, 4 leveling screw base, bronze center disc. Accepts 1/2x20 tripod mounting fastener. Aluminum circle, vernier	Pin wrench	9 R 46201	7		319.99
(8) 20 power	4.5 ft.	7 to 8 min.		H=15 min.	Same as (7)	Pin wrench	9 R 46172	6	4	219.99
(9) 20 power	4.5 ft.	9 to 11 min.		None	Anodized aluminum head, smooth running center. 4 brass leveling screws. Locking clamp screw to hold on point.	Pin wrench	9 R 46174	10	14	139.99

19 Wide-frame Tripods provide max. stability. Metal legs, hardware. Yellow with orange accent marks. Binding strap. Shifting type fastener w/1/2x20-in. thread. Fits (7, 8, 9).

Catalog Number	Shpg. wt.	Tripod alone	With transit
Stiff leg for flat terrain			
9 R 46086C	10 lbs.	\$79.99	\$69.99
Extension leg for uneven terrain			
9 R 46088C	11 lbs.	\$99.99	\$89.99

Wide-frame Tripods similar to (19) but with 3/8x11-in. thread instrument fastener. Fits (4, 6 and 46029).

Catalog Number	Shpg. wt.	Tripod alone	With transit
Stiff leg for flat terrain			
9 R 46101C	10 lbs.	\$89.99	\$79.99
Extension leg for uneven terrain			
9 R 46092C	12 lbs.	\$104.99	\$94.99

**SERVICE INFORMATION:** If your CRAFTSMAN or Sears Transit or Sighting Level needs adjustment or repair after warranty expires, contact nearest Sears store or catalog unit for fast factory service at reasonable cost.

Heavy-duty wide frame aluminum extension Tripod with 3/8x11-in. thread. Fits current (4, 6), 46029 (underlist of 2), past (46028, 4611, 46116). Wt. 13 lbs. 9 R 46094C ... Tripod alone **\$139.99**

Price when you also buy transit ... **\$129.99**

Alum. extension Tripod with 3/8x8-in. thread. Fits (2, 3, 5). Wt. 13 lbs. 9 R 46094C ... Tripod alone **\$149.99**

Price when you also buy transit ... **\$139.99**

Standard wide frame. Tripod of wood and aluminum. 3/2"x8-in. thread. Fits (2, 3, 5).

Catalog Number	Shpg. wt.	Tripod alone	With transit
Stiff leg for flat terrain			
9 R 46102L	10 lbs.	\$99.99	\$89.99
Extension leg for uneven terrain			
9 R 46095C	12 lbs.	\$119.99	\$109.99

Increase power and leverage with hoists, pullers, chains and rope



Steel chain hoist

1

Rope hoist

2



**CRAFTSMAN**  
Puller-hoist with up to 4000-lb. pull capacity

Available at Sears only in Catalog. Steel chain hoist has worm-gear drive with bronze and ball thrust bearings. Adjustable anti-slip safety brake. Aluminum alloy housing. Incl. 13-ft. chain, 360° swivel hooks, safety latch. Never exceed stated load capacity.

Capacity lbs.	Leverage	Chain diam.	Catalog Number	Wt. lbs.	Price
1000	30:1	1/4-in.	9 R 78703C	23	\$159.99
2000	30:1	1/4-in.	9 R 78704C	31	199.99
4000	50:1	3/8-in.	9 R 78705C	44	259.99

2 Rope hoist has 600-lb. capacity. 3-in. diam pulley has steel roller bearings, positive locking brake. Full-swivel steel hooks ease load positioning. Incl. 25 ft. of 3/8-in. diam. sisal rope. 4:1 leverage ratio. Never exceed stated load capacity. 9 R 7812—Shipping weight 6 pounds...\$30.99

3 Available at Sears only in Catalog. Crank cable hoist has 1500-lb. cap. Antislip automatic stop. Aluminum alloy housing. 3/8-in. diam. steel cable has swivel hooks for load positioning. Leverage ratio of 40:1. 12-ft. max. lift. Never exceed stated load cap. 9 R 7885—Shpg. wt. 8 lbs. 3 oz....\$79.99

4 Available at Sears only in Catalog. Crank strap hoist has 1500-lb. capacity and is identical to (3) except has a 1 1/4-in. wide nylon strap to help prevent marring of finishes. 40:1 leverage ratio. 10-ft. max. lift. Never exceed stated load capacity. 9 R 7889—Shpg. wt. 8 lbs. 5 oz....\$89.99

5 CRAFTSMAN puller-hoist has ratcheting action to help ease pulling or lifting. Laminated steel ratchet drum. Heat-treated drive and stop assembly. 3/8-in. diameter aircraft-type steel cable with hook.

Pull/lift cap.-lbs.	Max. lift	Leverage	Catalog Number	Wt.		Price
				lbs.	oz.	
4000/2000	6-ft.	10:1	9 R 7867	8	3	\$37.99
2000/1000	12-ft.	10:1	9 R 7866	6	8	27.99

6 Available at Sears only in Catalog. Quick-release wire grip for (5) or use alone. Grips any 1/8 to 1/4-in. diameter wire or sheet metal without special fastener. 1300-lb. capacity. 9 R 7831—Shipping weight 1 pound...\$9.99

7 Available at Sears only in Catalog. Heavy-duty, proof-coil, high-test steel chain has 2 hooks for heavy-duty pulling, lifting or anchoring. Proof-coiled steel, welded and galvanized. Drop-forged steel hooks.

Chain	Size in.	Work load	Lgth. feet	Catalog Number	Wt. lbs.	Price each
Good	1/4	1250 lbs.	14	9 R 77221	11	\$19.99
Better	3/8	1900 lbs.	14	9 R 77222C	16	27.99
Premium	3/8	2650 lbs.	14	9 R 77223C	23	35.99
Best	3/8	5400 lbs.	16	9 R 7767C	25	45.99

8 Available at Sears only in Catalog. Heavy-duty braided rope with 2 hooks has attached slip knots. Resistant to grease, oil and many chemicals. Our best is braid-on-braid nylon rope. Others of polypropylene.

Rope	Diam. in.	Load lbs.	Lgth. feet	Catalog Number	Wt.		Price
					lbs.	oz.	
Good	5/8	1170	11	9 R 76267	1	14	\$9.99
Better	3/4	1560	15 1/2	9 R 76268	2	10	12.99
Premium	7/8	2300	16	9 R 76269	3	2	19.99
Best	7/8	5660	15	9 R 76281	7	10	39.99

Versatile concrete mixers for professional projects or handyman jobs



3-cu. ft. dry capacity  
9 \$249<sup>99</sup>

5 1/2-cu. ft. dry capacity  
\$449<sup>99</sup>

6 1/2-cu. ft. dry capacity  
\$699<sup>99</sup>

9 \$12 MONTHLY, see p. 148. This compact mixer is ideal for do-it-yourself projects. 5 drum tilt positions. 3-cu. ft. dry cap., 1 1/2-cu. ft. mixing cap. Steel drum has reinforced opening. Hardened heavy-duty drive pinion for long life. 4 repl. mixer blades. Unassem. Motor and tow kit sold separately at right. Warranted. 9 R 75870N—Wt. 124 lbs....\$249.99

10 \$16 MONTHLY, see p. 148. Mixer has a 5 1/2-cu. ft. dry and 3-cu. ft. mixing cap. 5-position drum lever lock with adjustable tilt for best mixing action. Heavy-duty 12-ga. steel bowl, 18-ga. steel cone, 1-pc. cast-iron ring gear, 4 repl. blades. Bronze bearings with grease fittings, 2 on drum shaft, 2 on drive shaft. Solid angle steel frame and 3-in. steel channel yoke. Drip shield protects the motor. Unassem. Motor, tow kit sold sep. at right. Warranted. 9 R 75875N—Wt. 215 lbs....\$449.99

11 \$24 MONTHLY, see p. 148. Our heaviest-duty concrete mixer has 6 1/2-cu. ft. dry and 3 1/4-cu. ft. mixing cap. 11-ga. steel bowl and 16-ga. steel cone. 3-in. steel channel yoke is controlled with a 15 1/2-in. gear reduction tilt wheel with infinite adjustment of mixing positions. Tapered roller bearings, grease fittings, 2 on drum shaft, 2 on drive shaft. Heavy-duty 1-pc. cast-iron ring gear. 4 blades, 2 curved elevating shovels and 2 double-bladed agitators are all replaceable. Drip shield protects the motor. Assembled. Motor and tow kit sold separately at right. Warranted. 9 R 75876N—Wt. 290 lbs....\$699.99  
\*NOTE: Not for use as a tow trailer. Use is restricted to kit for concrete mixer jobs. Do not exceed 25 mph.

\$11 MONTHLY, see p. 148. This towing kit\* (not shown) with wheels is the perfect solution when portability is necessary. 2 ply, 4.10/3.50x4 pneumatic tires. Tapered roller bearings make rolling unit easy. 1 1/2-in. diameter ball and socket hitch with 5/8-in. bolt, draw bar and front support. Hooks easily to your vehicle. Fits (10) and (11). 9 R 75886C—Wt. 50 lbs....\$219.99

\$10 MONTHLY, see p. 148. This low speed hand tow kit (not shown) lets you move your mixer on job site with ease. 10x2.75 semi-pneumatic tires. Handlebar, axle and front support fits (9), (10) and (11). 9 R 75885C—Wt. 38 lbs....\$99.99

\$10 MONTHLY, see p. 148. 1/2-HP single phase electric motor (not shown) will power any mixer on this page. Has heavy-duty cord, V-belt, pulley and hardware. 115-v., 60-cycle AC. 9 R 75891C—Wt. 16 lbs....\$119.99

\$10 MONTHLY, see p. 148. 1/2-HP single phase electric motor (not shown) fits (10) and (11). This motor features a thermal switch that helps prevent motor burnout due to mixer overload. Includes heavy-duty cord, V-belt, pulley and hardware. 115-v., 60-cycle AC. 9 R 75892C—Wt. 16 lbs....\$129.99

\$14 MONTHLY, see p. 148. 3-HP, 4-cycle gas engine with easy-spin recoil starting (not shown) and 6:1 gear reduction powers all mixers on this page. Incl. steel hood to protect engine, V-belt, pulley, hardware. 9 R 75893N—Wt. 75 lbs....\$329.99

\*Warranted by Sears, write for free copy, see p. 148.

# Cement and drywall tools by Goldblatt

## Save 20%

when you buy any 3 or more (1 thru 28)



1 High carbon steel trowel with blade and mounting locked together so work surface stays flat.

Blade size, in.	Catalog Number	Wt. lb.	ea. oz.	Each	Any 3 or more, ea.
12x4	9 R 40071	1	...	\$18.99	\$15.19
14x4	9 R 40072	1	1	19.99	15.99
18x4	9 R 40073	1	5	23.99	19.19

2 Long lasting 6x4 1/2-inch bronze groover is weighted for easy, clean grooves. Shpg. wt. each 2 lbs.

Groove size, in.	Catalog Number	Each	Any 3 or more, ea.
3/8x3/4	9 R 40074	\$19.99	\$15.99
1/2x1	9 R 40075	23.99	19.19

3 6x3-in. stainless steel universal groover makes 1/2x1/2-in. grooves. 9 R 40076—Wt. ea. 1 lb. . . Ea. \$6.99 Any 3 or more, ea. . . \$5.59

4 Stainless steel edgers are rust resistant and durable. 6x3-inch. Curved-end edger (not shown). Wt. 10 oz. 9 R 40077 . . . Ea. \$4.99 Any 3 or more, ea. . . \$3.99 6x3 1/2-in. Flat-end edger. Wt. 12 oz. 9 R 40078 . . . Ea. \$5.49 Any 3 or more, ea. . . \$4.39 6x4-inch. Flat-end edger. Wt. 14 oz. 9 R 40079 . . . Ea. \$5.49 Any 3 or more, ea. . . \$4.39

5 Fluted silicon-carbide rub brick is a fast-cutting medium for dressing concrete. 6x3x1 in. 20 grit. 9 R 40083—Wt. ea. 1 lb. 10 oz. Ea. \$10.99; Any 3 or more, ea. . . \$8.79

6 16x3 1/2-in. bevel-end magnesium float is extra-light, yet very hard and long wearing. Wt. ea. 1 lb. 6 oz. 9 R 40086 . . . Ea. \$14.99 Any 3 or more, ea. . . \$11.99

7 Pointing trowel w/5 1/2-in. blade. One-pc. forged steel construction. 9 R 40082—Wt. ea. 4 oz. . . Ea. \$6.49 Any 3 or more, ea. . . \$5.19

8 5x2-in. blade margin trowel of fine high-quality carbon steel. 9 R 40081—Wt. ea. 4 oz. . . Ea. \$6.49 Any 3 or more, ea. . . \$5.19

9 Cement finishing kit incl. edger, groover, float, flat and pointed trowels, manual. Wt. ea. 6 lbs. 9 R 40101 . . . Ea. \$43.99 Any 3 or more, ea. . . \$35.19

10 Brickform patterns. Easily convert newly poured concrete into attractive brick or stone appearance. Rugged, high-strength plastic. Instr. incl. Wt. ea. 7 lbs. T 9 R 40108—Cobble T 9 R 40109—Brick Ea. \$69.99; Any 3 or more, ea. \$55.99

11 Round hole jitterbug tamper brings fine material to the surface for finishing. Ruggedly constructed with cupped grill that keeps splashing mud from your feet. 6 1/2 inches wide. 36-in. long. Shpg. wt. ea. 12 lbs. 8 oz. 9 R 40093L . . . Ea. \$42.99 Any 3 or more, ea. . . \$34.39 48-in. long. Shpg. wt. ea. 16 lbs. 9 R 40094N . . . Ea. \$44.99 Any 3 or more, ea. . . \$35.99

12 Lightweight magnesium bull float with flat face. Magnesium gives a smooth slab by reducing clinging. 42x8-in. Shpg. wt. ea. 10 lbs. 2 oz. T 9 R 40089C . . . Ea. \$79.99 Any 3 or more, ea. . . \$63.99 48x8-in. Shpg. wt. ea. 10 lbs. 14 oz. 9 R 40092C . . . Ea. \$84.99 Any 3 or more, ea. . . \$67.99

13 6-ft. x 1 1/4-in. aluminum extension handle fits 42-in. or 48-in. bull float. Easy-to-join molded threads. Shpg. wt. ea. 2 lbs. 9 R 40088C . . . Ea. \$23.99 Any 3 or more, ea. . . \$19.19

14 Lightweight taping knives with wide, flexible spring steel blade in rust-resistant aluminum mounting. 8x3 1/4-in. blade. Shpg. wt. 8 oz. 9 R 41212 . . . Ea. \$7.49 Any 3 or more, ea. . . \$5.99 12x3 1/2-in. blade. Shpg. wt. 12 oz. 9 R 41214 . . . Ea. \$9.99 Any 3 or more, ea. . . \$7.99

15 Stainless steel inside corner taping tool. 80° between blades, flexes, to 90°. 9 R 41204—Wt. ea. 8 oz. . . Ea. \$9.49 Any 3 or more, each . . . \$7.59

16 9 1/2x3 1/4-in. drywall hand sander is balanced to ease use. Shpg. wt. ea. 14 oz. 9 R 41217 . . . Ea. \$9.49 Any 3 or more, each . . . \$7.59

17 Drywall T-square with lip. Gold color anodized with black markings. 2-in. blade measures 48 in. with 6 in. on short end and 16 in. on long end of "T". Stud locator holes on rule tell where to nail. Wt. ea. 2 lbs. 9 R 41206L . . . Ea. \$19.99 Any 3 or more, each . . . \$15.99

18 Utility saw has 6-in. blade with sharp point for easy penetration. 9 R 41209—Wt. ea. 3 oz. . . Ea. \$4.99 Any 3 or more, each . . . \$3.99

19 14x4 3/4-in. plastic mud pan. 9 R 41211—Wt. ea. 12 oz. Ea. \$4.99; Any 3 or more, ea. . . \$3.99

20 Do-it-yourself drywall finishing kit incl. taping knives, corner and seam tape, mud pan, sandpaper, sander and instructions. Wt. ea. 6 lbs. 9 R 40102 . . . Ea. \$41.99 Any 3 or more, each . . . \$33.59

21 Dry tape Banjo® holds 500-foot roll of tape in dry compartment. Aluminum construction is leak-proof. T 9 R 41207—Wt. ea. 4 lbs. 8 oz. Ea. \$93.99; Any 3 or more, ea. \$75.19

22 11x4 3/8-in. die-cut 80-grit sandpaper. 10 sheets per pkg. 9 R 41216—Wt. ea. 6 oz. . . Pkg. \$2.79 Any 3 or more, ea. pkg. . . \$2.23

23 Swift mixer effectively mixes in containers up to a 30-gal. drum. Use with any 1/2-in. slow speed drill. Aluminum paddle is 8 1/2x5 in., shaft is 7/8x30 in. Wt. ea. 1 lb. 12 oz. 9 R 41208C . . . Ea. \$12.99 Any 3 or more, each . . . \$10.39

24 9 1/2x3 1/4-in. long-handle drywall sander has patented "universal" swivel device attached to 48-in. handle. 9 R 41218C—Wt. ea. 1 lb. 15 oz. Ea. \$14.99; Any 3 or more, ea. \$11.99

25 \$11 monthly\*\* Shujax® adjustable stilts are made with genuine "walking action". Mechanical ankle and special spring supplements leg muscles. Adjustable from 18-28 inches. Includes heel cup, straps. 225-lb. capacity. Shpg. wt. pair 14 lbs. 8 oz. T 9 R 41205C . . . Pair \$214.99 Any 3 or more, each pr. . . \$171.99

26 Gun and hopper maintenance kit incl. everything needed to maintain or repair. Pattern pistol. 9 R 41221—Wt. ea. 6 oz. . . Ea. \$16.49 Any 3 or more, each . . . \$13.19

27 Pattern pistol® gun and hopper sprays premix acoustics, drywall mud, texture paints, glitter, waterproofing and more. Includes 3/2-inch and 1/8-inch air nozzles. Plastic hopper is dent, rust-resistant. 1 1/4-gallon capacity. T 9 R 41201—Wt. ea. 4 lbs. 2 oz. Ea. \$92.99; Any 3 or more, ea. \$74.39



28 \$22 monthly\*\* Pattern pistol® with compressor has 1-HP capacitor-start motor. Incl. 50-ft. of 1/2-in. air hose, 25 ft. of power cable, gun, hopper and instr. Partially assembled. Warranted by Goldblatt, write for free copy, see p. 148. T 9 R 41202N—Wt. ea. 108 lbs. Ea. \$649.99; Any 3 or more, ea. \$519.99

29 and 30 Bricklayer and mason tools made by Dasco Pro feature exclusive targethead design which gives a large striking area and extra protection to the hand, while reducing mushrooming and spalling.

29 Deluxe 3-piece bricklayers' kit includes 4-in. wide chisel with sharp blade for scoring and cutting; plugging chisel to clean mortar from brick joints; and tapered jointer to smooth horizontal and vertical mortar joints. 9 R 36875—Wt. 3 lbs. . . Kit \$19.77 3-in. brick set. 9 R 40121—Wt. 1 lb. . . \$6.99 3 1/2-in. brick set. 9 R 40122—Wt. 1 lb. . . \$7.99 4-in. brick set. 9 R 40123—Wt. 1 lb. . . \$8.99

30 3-pc. masons' kit includes masons' chisel with thin blade for clean cuts on cement block, cinder block, and veined stone; tooth chisel with sharp teeth for cutting soft stone; 3 1/2-in. wide brick set for scoring, cutting and trimming bricks and blocks. 9 R 36876—Wt. 2 lbs. . . Kit \$19.77 1 1/4-in. masons' chisel. 9 R 36901—Wt. 1 lb. . . \$6.49 1 3/4-in. masons' chisel. 9 R 36902—Wt. 1 lb. . . \$6.99 2 1/4-in. masons' chisel. 9 R 36903—Wt. 1 lb. . . \$7.99

\*See "N" note, p. 148.  
\*\*See page 148.  
Items with "T" prefix (such as T 9 R 40108) could take extra time for delivery

# Fine woodworking demands fine tools



Chisel Sets



Screwdriver Sets

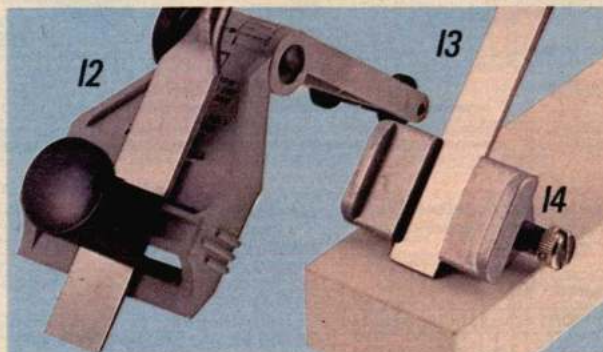

Solid maple woodworking bench includes vises and drawer



Comes with set (21)

**1 thru 29** These fine Woodworking Tools help you achieve the pride of Old World craftsmanship in your own workshop. Available only in our catalog, except items (1, 2 and 25 thru 29) which are also available at most Sears stores.

**1 CRAFTSMAN® 3-piece chisel set** features precision ground high-carbon steel blades with plastic handles. Incl. 1/8, 3/16, 1-inch sizes. Warranted\*. 9 R 36861—Shpg. wt. 1 lb. 4 oz. . . Set \$14.99

**Individual Chisels (same construction as (1))**

Width	Catalog Number	Shpg. wt.	Price
1/8 inch	9 R 36822	5 oz.	\$6.49
3/16 inch	9 R 36823	6 oz.	7.49
1 inch	9 R 36824	7 oz.	8.49
1 1/4 inches	9 R 36825	8 oz.	9.49

**2 Sears 3-pc. chisel set** has drop-forged heat-treated high-carbon steel blades; plastic handles. Incl. 1/8, 3/16, 1-in. sizes. Storage pouch. 9 R 36891—Shpg. wt. 13 oz. . . Set \$8.49

**3 4-piece hornbeam-handled chisel set (not as shown)** includes 1/8, 1/4, 3/8, 1-inch sizes. Thin, chrome vanadium blades are ideal for cutting dovetails and delicate paring jobs. Imported. 9 R 42825—Shpg. wt. 1 lb. 4 oz. . . Set \$39.99

**Individual hornbeam handled chisels. Imported.**

Width	Catalog Number	Shpg. wt.	Price
1/8 inch	9 R 42826	3 oz.	\$9.99
1/4 inch	9 R 42827	3 oz.	9.99
3/8 inch	9 R 42828	3 oz.	9.99
1 inch	9 R 42829	4 oz.	9.99
1 1/4 inch	9 R 42831	4 oz.	9.99
1 1/2 inch	9 R 42832	5 oz.	10.99
1 3/4 inch	9 R 42833	6 oz.	11.99
1 7/8 inch	9 R 42834	7 oz.	11.99
1 3/4 inches	9 R 42835	7 oz.	14.99
1 1/2 inches	9 R 42836	8 oz.	16.99

**4 Cabinetmakers' 6-piece screwdriver set** has forged blades, taper-ground tips, oval beech handles. Incl. 1/8x2 1/2, 3/16x3, 1/4x4, 5/16x5, No. 1 (3-in.) and No. 2 (4-in.) Phillips sizes. Imported. 9 R 37033—Shpg. wt. 1 lb. 2 oz. . . Set \$29.99

**5 Rugged 4-piece screwdriver set** can handle most any job. One-piece, forged blade and handle has smooth, oval shaped hardwood grips riveted to each side of handle for comfort. Set includes 6, 8, 10, and 12-inch long screwdrivers. 9 R 37102—Shpg. wt. 1 lb. 10 oz. . . Set \$9.99

**6 3-piece Phillips screwdriver set** is ideal for those unusually tough projects. Durable, one-piece forged steel blade extends the length of the handle for added strength. Solid hardwood grips. Includes three sizes: Nos. 1, 2, 3 (6, 8, 10-in. long). 9 R 37103—Shpg. wt. 1 lb. . . Set \$9.99

**7 Round burnisher puts sharp burr edge on scrapers.** Hardened steel. Imported. 9 R 37015—Shipping weight 2 oz. . . \$7.99

**8 thru 10 Adjustable spokeshaves** finish curved surfaces. Tools are 10 in. long with 2 1/2-in. wide blades. Imported.

**8 Curved sole for concave surface.** 9 R 37041—Shipping weight 15 oz. . . \$19.99

**9 Crescent sole for concave surface.** 9 R 37056—Shipping weight 9 oz. . . \$7.99

**10 Straight sole for convex surface.** 9 R 37042—Shipping weight 14 oz. . . \$19.99

**11 3-piece cabinet scraper set** to fine-finish plane hard or tough-grained wood incl. 2 3/4x4 1/4-inch gooseneck, 2x5 3/4-inch round-end, 2 3/8x5 7/8-inch straight. Requires burnisher (7), sold at left. Imported. 9 R 37014—Shipping weight 4 oz. . . Set \$5.99

**12 Tool sharpener** has precise angle settings on graduated scale to give you proper angle for desired cutting edge. A positive locking mechanism provides accuracy. Constructed of lightweight fiber glass-filled plastic. Folds flat for easy storage. Sharpens chisels (not incl.), plane blades to 2 3/8 inches wide (stone not included). 9 R 6669—Shipping weight 9 oz. . . \$12.99

**13 Honing guide** for blades from 1/8 to 2 1/2 inches wide. Use with (14). Imported. 9 R 37048—Shipping weight 9 oz. . . \$9.99

**14 Water stones** are for quick edge grinding. Imported.

Grit Type	Catalog Number	Shpg. wt.		Price
		lbs.	oz.	
Coarse (800)	9 R 37046	1	15	\$7.99
Med. Fine (1500)	9 R 37047	1	15	8.49
Super Fine (6000)	9 R 37045	2	1	19.99

**15 10-oz. cabinetmakers' Warrington hammer** has 1 1/4-inch English ash handle. Imported. 9 R 37032—Shipping weight 15 oz. . . \$9.99

**16 One-hand scoop** is for hollowing, scooping and scraping wood projects with a hollow in their design (bowls, spoons, etc.). Removes excess wood quickly. Oak handle. Imported. 9 R 37401—Shipping weight 2 oz. . . \$10.99

**17 Cornering tools** chamfer edges of boards. 1/8, 3/16 and 1/4 inch. 1 pair. Imported. 9 R 37058—Shipping weight 3 oz. . . Pr. \$8.88

**18 Solid maple woodworking bench** provides a working surface of 15 1/2x70 inches and a clamping capacity of 74 1/4-in. End vise has a capacity of 6 1/2 in. with 3x15 1/2-in. face and 2 guide rods. Side vise has 8-in. capacity and shoulder design to hold work firmly in place. 34Lx8 1/4Wx2D-in. tool tray can be mounted on either side or end. Drawer is 25Lx13 1/2Wx3 1/2D in. Partially assembled. Measures 73Lx35 1/4Wx33H in. overall. Top portion is shown again below . . . just look at all the tools it accommodates! 9 R 65092N—Shipping weight 145 lbs. . . \$349.99

**19 6-pc. gouge set (not as shown)** has hornbeam handles. Blades are forged to #8 sweep. Includes 1/4, 3/8, 1/2, 5/8, 3/4, and 1-inch sizes. Imported. 9 R 42837—Shpg. wt. 1 lb. 14 oz. . . Set \$69.99

**20 11-pc. carving set (not as shown)** includes 1/4, 3/8, 1/2, 5/8-inch straight gouges, 3/8-in. skew chisel, 3/8-in. parting tool, tool roll, 2 sharpening stones, honing fluid and instruction book. Imported. 9 R 37054—Shipping weight 5 lbs. . . Set \$99.99

**21 7-pc. carving set** includes 3/16-in. straight and skew chisels, 1/4-in. straight gouge, 1/8-in. veiner, 3/16-in. parting tool, honing stone and carving pattern. Imported. 9 R 37039—Shipping weight 10 oz. . . Set \$29.99

\*Warranted by Sears, write for free copy, see page 148.

**22 6-pc. chip carving set (not as shown)** makes geometric pattern cuts. Knives hold a razor edge. Includes sizes from 5 1/4 to 8 in. long. Imported. 9 R 37055—Shipping weight 5 oz. . . Set \$29.99

**23 3-pc. shavehook set** for refinishing and use with molding or curved surfaces. Shapes include heart, triangular, combination. Imported. 9 R 36195—Shpg. wt. 1 lb. 4 oz. . . Set \$7.99

**24 Spring-loaded bench stops** sit flush to worktable top and act as a "dog" system to hold workpiece firmly in place. Set of 3. 9 R 37115—Shipping weight 1 lb. 14 oz. . . Set \$10.99

**25 6-pc. CRAFTSMAN® auger bit set** for hand braces or 3/8 to 1/2-in. electric drills. Incl. 1/8, 3/16, 1/4, 3/8, 1/2 inch sizes. Warranted\*. 9 R 41762—Shpg. wt. 1 lb. 3 oz. . . \$34.99

**3-pc. CRAFTSMAN® auger bit set** incl. 1/4, 3/8, 1/2-inch sizes. Warranted\*. 9 R 41761—Shipping weight 6 oz. . . \$17.99

**Individual Auger Bits**

Diameter	Catalog No.	Shpg. wt.	Price
1/8 inch	9 R 41751	1 oz.	\$4.99
3/16 inch	9 R 41752	2 oz.	5.49
1/4 inch	9 R 41753	2 oz.	5.99
5/16 inch	9 R 41754	4 oz.	6.49
3/8 inch	9 R 41755	4 oz.	6.99
1/2 inch	9 R 41756	6 oz.	7.99
1 inch	9 R 41757	7 oz.	8.99

**26 CRAFTSMAN push drill** has locking chuck, ideal for drilling small holes. Includes 8 drill points (1/16 to 1/8 inch). Warranted\*. 9 R 4221—Shipping weight 8 oz. . . \$19.99

Set of 8 replacement bits (1/16 to 1/8 inch). 9 R 42216—Shipping weight 1 oz. . . Set \$6.99

Lignum vitae mallet (not shown) has 3 1/2-inch diameter, round head. Imported. 9 R 45792—Shipping weight 1 lb. 10 oz. . . \$7.99

**27 CRAFTSMAN expansive bits** for (28) include 2 interchangeable steel blades. Tapered square shank. Warranted\*.

For holes	Catalog No.	Shpg. wt.	Price
1/8 to 1 1/4-in.	9 R 41758	4 ounces	\$12.49
3/8 to 3-in.	9 R 41759	8 ounces	12.99

**28 CRAFTSMAN medium-duty bit brace** has wooden head, center grip, 10 1/2-inch sweep. Alligator-type self-centering chuck. Open box ratchet. Imported. Warranted\*. 9 R 42404—Shipping weight 2 lbs. . . \$14.88

**29 Hand drill** has 3-jaw chuck, clamps bits to 1/4-in. diameter. Includes 4 bits. Overall 11 1/2 inches long. High impact plastic body. 9 R 42312—Shipping weight 12 oz. . . \$9.49

**SHOP BY PHONE**  
To order, call your local Sears store

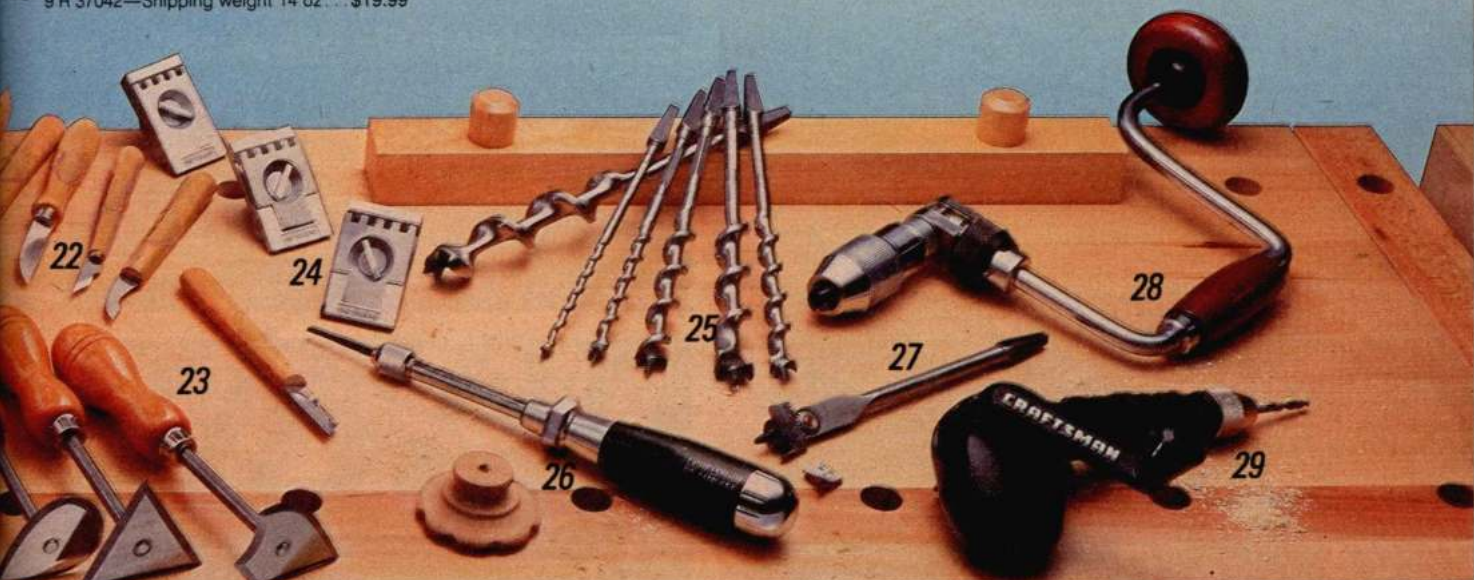

ONE QUALITY NAME

**CRAFTSMAN**

OFFERS MORE GOOD CHOICES

Achieve superior workmanship and create an almost endless variety of woodworking projects with this

## CRAFTSMAN® 12-inch Wood Lathe with 1/2 HP motor and Copy Crafter®

Cast-iron head, tool-rest, tailstock help eliminate chatter and vibrations for quality turnings

**\$379.98** \$15 MONTHLY\*

Available in Catalog only. CRAFTSMAN 12-inch wood lathe measures 37 inches between centers with turning capacity of 12 inches over bed for faceplate turning. 8-inch diameter over tool rest. Index pin has 36 equal spacings for accurate fluting. Hinged belt guard eases speed changes. Tailstock has No. 1 Morse taper. Overall 19x11x54 1/2 inches. 4-step machine and motor pulleys give speeds of 875, 1350, 2250, 3450 rpm. Includes Copy Crafter (3 below), 6 and 12-inch tool rest, spur, cup centers. Key lock switch helps prevent accidental starts. 6-foot, 3-wire cord. Warranted by Sears; write for free copy, see page 148. Wood turning tools sold separately on facing page.

9 R 23821N—Shipping weight 128 pounds... \$379.98

CRAFTSMAN 12-in. Lathe with motor. Like (1) but without Copy Crafter.  
9 R 22816N—Shipping weight 88 pounds... \$239.99

2 Available in Catalog only. CRAFTSMAN Diameter Sizing Gauge lets you size various diameters along length of a turning spindle without resetting caliper. 12 indicator arms in 16ths-in., plus mm markings to accurately size turnings up to 6-in. diam. and 36 in. long. Fits most CRAFTSMAN wood lathes.

9 R 24909C—Shipping weight 6 pounds... \$49.99

Available in Catalog only. Lathe Gauge Set (not shown) is a set of 6 additional indicators for (2).

9 R 24911—Shipping weight 1 pound 4 ounces... Set \$17.99

3 Available in Catalog only. CRAFTSMAN Copy Crafter follows outline of original turning or template as it duplicates piece. Makes spindles up to 36 in. long. 2 1/2-in. diam. from turning (6-in. diam., 36-in. long from template). Duplicates shallow faceplate turnings to 8-in. diam. from template. Incl. sharpening stone, hardware, instructions. Warranted by Sears; write for free copy, see p. 148.

9 R 24907C—Shipping weight 40 pounds... \$139.99

Available in Catalog only. High-speed tool steel Replacement Bit for Copy Crafter (not shown).

9 R 24908—Shipping weight 1 ounce... \$4.99

4 Available in Catalog only. Aluminum and steel Lathe Sanding Table has 3/4x3/8-inch groove for miter gauge and 2 1/2 inch opening for attaching wet/dry vacuum. Use with 9-in. diam. sanding disc (5), sold below.

9 R 24922—Shipping weight 10 pounds... \$59.99

5 Available in Catalog only. 9-inch diameter Sanding disc has 3/4-16 thread. Use with (4).

9 R 24906—Shipping weight 1 pound 9 ounces... \$19.99

6 Available in Catalog only. Speed Reducer provides belt shifting to lower speeds. Reduces speed to as low as 300 rpm with 1725 rpm, 48 to 56 frame motors.

9 R 23895—Shipping weight 8 pounds 2 ounces... \$44.99

7 8-piece Precision/Hobby Tool Set for large or small hobby lathes. 3 1/2-inch high speed steel blades. 5 1/2-inch handles.

9 R 2984—Shipping weight 1 pound 6 ounces... Set \$39.99

\*See page 148.



CRAFTSMAN Bench Power Tools

**America's Best Sellers**



Spear-point cleans, corners, cuts vees, beads

Round-nose cuts curves, smooths curved surfaces

Gauges reduce piece to a round of approx. desired size

Skews cut vees, beads and square shoulders

Parting tool cuts straight into pieces as deep as desired



**8 thru 10** Heavy-duty cast-iron faceplates fit  $\frac{3}{4}$ -16 inch threaded arbor.

Diam.	Holes for workpiece	Catalog Number	Shpg. wt.	Price
8) 6-in.	6 mounting holes	9 R 24904	2 lbs. 12 oz.	\$24.99
9) 4-in.	6 mounting holes	9 R 2489	1 lb. 4 oz.	14.99
10) 3-in.	3 mounting holes	9 R 20912	1 lb. 2 oz.	15.99

**11** New at Sears!  $6\frac{1}{2}$ -in. diam. four-jaw chuck with  $\frac{3}{4}$ -16-in. threads per in. Threads onto wood lathe spindle. Reversible jaws for inside or outside holding of work piece.  $6\frac{1}{4}$ -in. max. inside hold;  $5\frac{3}{8}$ -in. outside hold. 9 R 22560—Shipping weight 5 pounds 4 ounces... \$49.99

**12** Bowl-turning rest replaces regular tool rest for making inside and contour cuts on faceplate turnings. Made of cast-iron.  $\frac{3}{8}$ -inch diameter shank. 9 R 24903—Shipping weight 3 pounds 8 ounces... \$24.99

**13 and 14** These centers fit  $\frac{3}{8}$ -inch arbors. Wt. 4 oz.

**13** Headstock Spur 9 R 21052... \$6.29      **14** Tailstock Cup 9 R 21022... \$5.79

**15** Work arbors have 2 steel flanges. Nut on head clamp wheels.  $\frac{1}{2}$ -20 threaded.

Morse Taper 1, Wt. 8 oz.      Morse Taper 2, Wt. 10 oz.  
9 R 21534... \$6.29      9 R 21522... \$6.29

Draw bolt (not shown) secures center and work arbor for (9 R 21534) sold above.

9 R 21542—Shipping weight 2 ounces... \$2.29

**16** Work arbors with chuck have  $\frac{1}{2}$ -inch capacity,  $\frac{1}{2}$ -20 thread, 3-jaw screw-on.

Morse Taper No. 1      Morse Taper No. 2  
Shpg. wt. 1 lb. 2 oz.      Shpg. wt. 1 lb. 4 oz.  
9 R 22344... \$11.49      9 R 22472... \$11.49

\*Warranted by Sears.  
write for free copy, see page 148.



**17 thru 21** Morse Taper Centers

Tool	Morse Taper	Catalog Number	Shpg. wt.	Price
60-degree (17)	No. 1	9 R 21102	2 oz.	\$5.29
	No. 2	9 R 21112	5 oz.	5.79
Spur (18)	No. 1	9 R 21062	3 oz.	\$5.79
	No. 2	9 R 21072	6 oz.	7.29
Screw (19)	No. 1	9 R 21164	5 oz.	\$7.29
	No. 2	9 R 21152	8 oz.	7.29
Tailstock Cup (20)	No. 1	9 R 21002	2 oz.	\$5.29
	No. 2	9 R 21012	5 oz.	5.79
60-degree Ball Bearing (21)	No. 1	9 R 21122	7 oz.	\$11.49
	No. 2	9 R 21132	10 oz.	13.49

**22 thru 29** CRAFTSMAN English-style wood-turning tools are made with triple-tempered,  $4\frac{1}{8}$ -inch blades. Made in USA. Warranted\*.

Tool	Catalog Number	Wt. oz.	Price
(22) $\frac{1}{4}$ -in. Gouge	9 R 28501	7	\$7.99
(23) $\frac{1}{2}$ -in. Gouge	9 R 28502	8	7.99
(24) $\frac{3}{4}$ -in. Gouge	9 R 28503	10	8.99
(25) $\frac{1}{2}$ -in. Spear-point	9 R 28504	10	7.99
(26) $\frac{1}{2}$ -in. Round-nose	9 R 28505	10	7.99
(27) $\frac{1}{2}$ -in. Parting Tool	9 R 28506	7	7.99
(28) $\frac{1}{2}$ -in. Skew Chisel	9 R 28507	9	7.99
(29) 1-in. Skew Chisel	9 R 28508	10	8.99

Save \$5.93 when you buy 8-pc. set. Incl. (22 thru 29). Made in USA. Sep. prices total \$65.92. 9 R 28509—Shpg. wt. 4 lbs. 8 oz. Set \$59.99

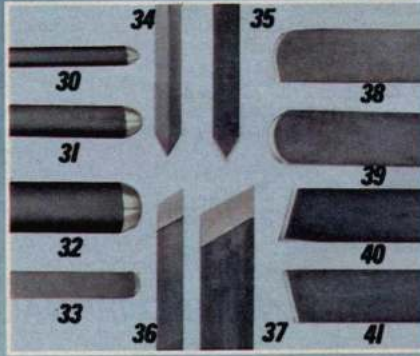

**30 thru 41** CRAFTSMAN wood-turning tools with high-speed steel cutting edges. Triple-tempered  $4\frac{1}{8}$ -inch blades.

Tool	Catalog Number	Wt. oz.	Price
(30) $\frac{1}{4}$ -in. Gouge	9 R 28521	5	\$7.49
(31) $\frac{1}{2}$ -in. Gouge	9 R 28522	6	7.99
(32) $\frac{3}{4}$ -in. Gouge	9 R 28523	8	9.79
(33) $\frac{1}{2}$ -in. Round-nose	9 R 28525	8	7.49
(34) $\frac{1}{2}$ -in. Parting Tool	9 R 28526	5	7.49
(35) $\frac{1}{2}$ -in. Spear-point	9 R 28524	8	7.69
(36) $\frac{1}{2}$ -in. Skew Chisel	9 R 28527	7	7.49
(37) 1-in. Skew Chisel	9 R 28528	8	9.79
(38) Half-round	9 R 28531	9	9.79
(39) Full round	9 R 28532	9	9.79
(40) Left Skew	9 R 28533	9	9.79
(41) Right Skew	9 R 28534	9	9.79

Save \$19.39 when you buy this 12-pc. set. Includes (30 thru 41). Separate prices total \$104.38. 9 R 2867—Wt. 5 lbs. 13 oz. Set \$84.99

Save \$12.23 when you buy this 8-pc. set. Incl. (30 thru 37). Sep. prices total \$65.22. 9 R 2859—Wt. 3 lbs. 8 oz. Set \$52.99

Save \$4.57 when you buy this 4-pc. set. of spindle-turning tools. Includes (32, 33, 34, 37). Separate prices total \$34.56. 9 R 2853—Wt. 1 lb. 14 oz. Set \$29.99

Save \$5.17 when you buy this 4-pc. set. of spindle-turning tools (38 thru 41). Separate prices total \$39.16. 9 R 2869—Wt. 2 lbs. 5 oz. Set \$33.99

# Electric glue guns form tight bond in minutes... ideal for woodworking projects or repair jobs around the home, shop or school

**CRAFTSMAN cordless glue gun works anywhere... with or without a cord**

- ✓ Detachable cord does double duty... attaches to stand or directly to gun for conventional use
- ✓ Cradle-type holder doubles as charging stand and has on/off switch that eliminates unplugging unit after use



**\$24.99**

**CRAFTSMAN industrial glue gun \$29.99**

**Our finest CRAFTSMAN Glue Gun has a unique no-drip tip that virtually eliminates glue dripping \$18.99**

**\$27.99 outfit with caddy**

**Glue gun with preset thermostat \$13.99**

**Sears Mini-glue gun sets down an extra-fine bead of glue \$6.99**

**1 thru 5 UL listed AC. Warranted by Sears, write for free copy, see p. 148. Glue sticks sold at right.**

**1** The best of both worlds is yours with this CRAFTSMAN cordless glue gun. Trigger-fed gun has special self-sealing silicon valve that prevents glue backup. Solid-state heater melts up to three 4-in. glue sticks before reheating. 2 min. recycling time. Double-duty cord connects to gun for use conventionally or to cradle-type holder for reheating. 6-ft. cord. 9 R 80548—Wt. 1 lb. 8 oz... **\$24.99**

**2** Our finest CRAFTSMAN glue gun has special self-sealing silicon valve prevents glue backup. Trigger action, on/off light. Solid state heater for steady heat. Uses 4-in. glue sticks. 9 R 80523—Wt. 1 lb... **\$18.99**

Glue gun outfit includes CRAFTSMAN glue gun (2) and caddy below. Also incl. twelve 4-in. glue sticks and wide, narrow bead nozzles.

9 R 80543—Wt. 2 lbs... **\$27.99**  
Plastic caddy (not shown) holds all glue guns except (5) and up to 12 glue sticks (incl.). Wall mountable. Also incl. wide, narrow bead nozzles. Glue gun not incl. Approx. 7x4x6 in. high. 9 R 80514—Wt. 8 oz... **\$9.99**

**3** CRAFTSMAN industrial quality glue gun uses std. 1/2-in. diam. glue sticks sold at right. Dual solid-state heaters increase glue flow greatly for rapid coverage. Pressure regulating trigger feed reduces finger fatigue. Removable glue chamber cover for easy cleaning. Wire stand. 9 R 80549—Wt. 1 lb. 3 oz... **\$29.99**

**4** Sears trigger-fed glue gun has a solid state heater for steady heat flow. Special self-sealing silicon sleeve prevents glue backup. Unique aluminum nozzle virtually eliminates dripping. Wire stand. Hi-impact plastic housing. 9 R 80510—Wt. 1 lb. 1 oz... **\$13.99**

**5** Mini household glue gun is ideal for repairs, crafts, hobbies. Eliminates messy glue bottles and leaky tubes. Compact size fits easily in your drawer or tool box. Durable impact-resistant housing. Micro-electronic circuitry. Wire stand. Additional glue sticks sold below. 9 R 80527—Wt. 5 oz... **\$6.99**

Mini-glue sticks for glue gun above. Package of 12 clear glue sticks. 9 R 80540—Wt. 2 oz... Pkg. **\$2.49**

## Glue sticks

Fits glue guns 1, 2 and 4. 4-in. long. Package of 40. Sticks have perforated centers so that they are useable with gun 9-80500 which take 2-in. size.

Clear 9 R 80537—Wt. 1 lb... Pkg. **\$8.49**

White caulk 9 R 80535—Wt. 1 lb... Pkg. **\$8.49**

Time delay—clear 9 R 80533—Wt. 1 lb... Pkg. **\$8.49**

For (3). 10-in. long. Package of 10.

Clear. Wt. 1 lb. 2 oz.

9 R 80553... Pkg. **\$4.99**

Slow Set. Wt. 1 lb. 2 oz.

9 R 80554... Pkg. **\$4.99**

## WE'VE REINVENTED THE NAIL!

Hang Fast wall mounting system hangs pictures, kitchen utensils, towels and more without any permanent damage!

- ✓ Unique disc system bonds to most clean surfaces in less than 15 seconds! Removes just as easily with no unsightly holes to patch.
- ✓ Attaches in only 4 simple steps. Ideal for ceramic tile, metal, plastic and other smooth, hard non-porous surfaces.



**STEP 1:** Clean surface. Place adhesive disc in holder and heat



**STEP 2:** Press holder with disc against surface, hold 15 seconds



**STEP 3:** Remove holder and disc is attached to wall.



**STEP 4:** Attach special hooks to disc and it's ready

**6** Hang Fast wall mounting system uses the latest in adhesive technology to form strong bonds in 15 sec. or less. No nails, screws or holes to patch! Holds up to 20 lbs. Discs remove just as easily with built-in remover. Leaves little or no residue. Any residue wipes clean with mineral spirits or alcohol. Incl. 4 discs. Extra discs and hooks sold at right. UL listed. 6-ft. cord. Warranted by Sears, write for free copy, see p. 148. 9 R 80481—Shpg. wt. 1 lb... **\$12.99**

Hang fast accessories. Disc has molded lip for hanging pictures, etc. Utility hooks and wardrobe hooks slide over the adhesive disc to allow you to hang clothes, kitchen utensils, towels and much more.

Item	Qty.	Catalog Number	Wt. oz.	Pkg.
Adhesive Discs...	10	9 R 80482	5	<b>\$1.99</b>
Utility Hooks..	2	9 R 80483	4	<b>1.99</b>
Wardrobe Hooks..	2	9 R 80484	4	<b>1.99</b>

## Quality adhesives for most bonding jobs



**7 thru 18** Help you get the professional results you want. For home, marine jobs, shop and many other uses.

Type and use of glue	Am't.	Catalog No.	Shpg. wt.	Price
(7, 12) Titebond Wood Glue. Quick drying for any wood application. Bonds stronger than wood itself.	4-oz.	9 R 80625	8 oz.	<b>\$1.49</b>
	8-oz.	9 R 80617	10 oz.	<b>1.99</b>
	Gal.	9 R 80626	9 lbs. 11 oz.	<b>14.99</b>
	Pint	9 R 80618	1 lb. 4 oz.	<b>3.49</b>
	Quart	9 R 80621	2 lbs. 8 oz.	<b>4.99</b>
(8) Construction adhesive for remodeling and repair maintenance.	Gal.	9 R 80873	10 lbs. 3 oz.	<b>16.99</b>
	Quart	9 R 80872	2 lbs. 10 oz.	<b>4.99</b>
(9) Fast drying contact cement. Solvent based for laminating counter tops, plywood.	Pint	9 R 80656	1 lb. 6 oz.	<b>3.49</b>
(10) Mendwood... for repair of cracks, holes, chips. Sandable and stainable.	8-oz.	9 R 80883	8 oz.	<b>1.99</b>
(11) White glue for use in general, all-purpose products.	4-oz.	9 R 80612	9 oz.	<b>99c</b>
	8-oz.	9 R 80613	14 oz.	<b>1.69</b>
	Pint	9 R 80614	1 lb. 4 oz.	<b>2.79</b>
(13) Panel and Plywood adhesive for paneling, wallboard and similar products.	10 oz.	9 R 80876	10 oz.	<b>1.19</b>
	1 lb.	9 R 80877	1 lb. 13 oz.	<b>2.99</b>
(14) General construction adhesive bonds most substrates.	10.05 oz.	9 R 8087	10 oz.	<b>1.99</b>
(15) Multibond Mastic for decks, treated lumber.	10 oz.	9 R 80882	10 oz.	<b>1.69</b>
(16) Adhesive caulk for home, marine use. Caulks, seals in 1 operation.	10 oz.	9 R 80881	10 oz.	<b>2.79</b>
(17) Fast-drying adhesive for home, shop, crafts.	8 oz.	9 R 80652	8 lbs.	<b>3.99</b>
(18) Hide glue. Slow-setting for precise assembly.	11 oz.	9 R 80623	10 oz.	<b>2.99</b>

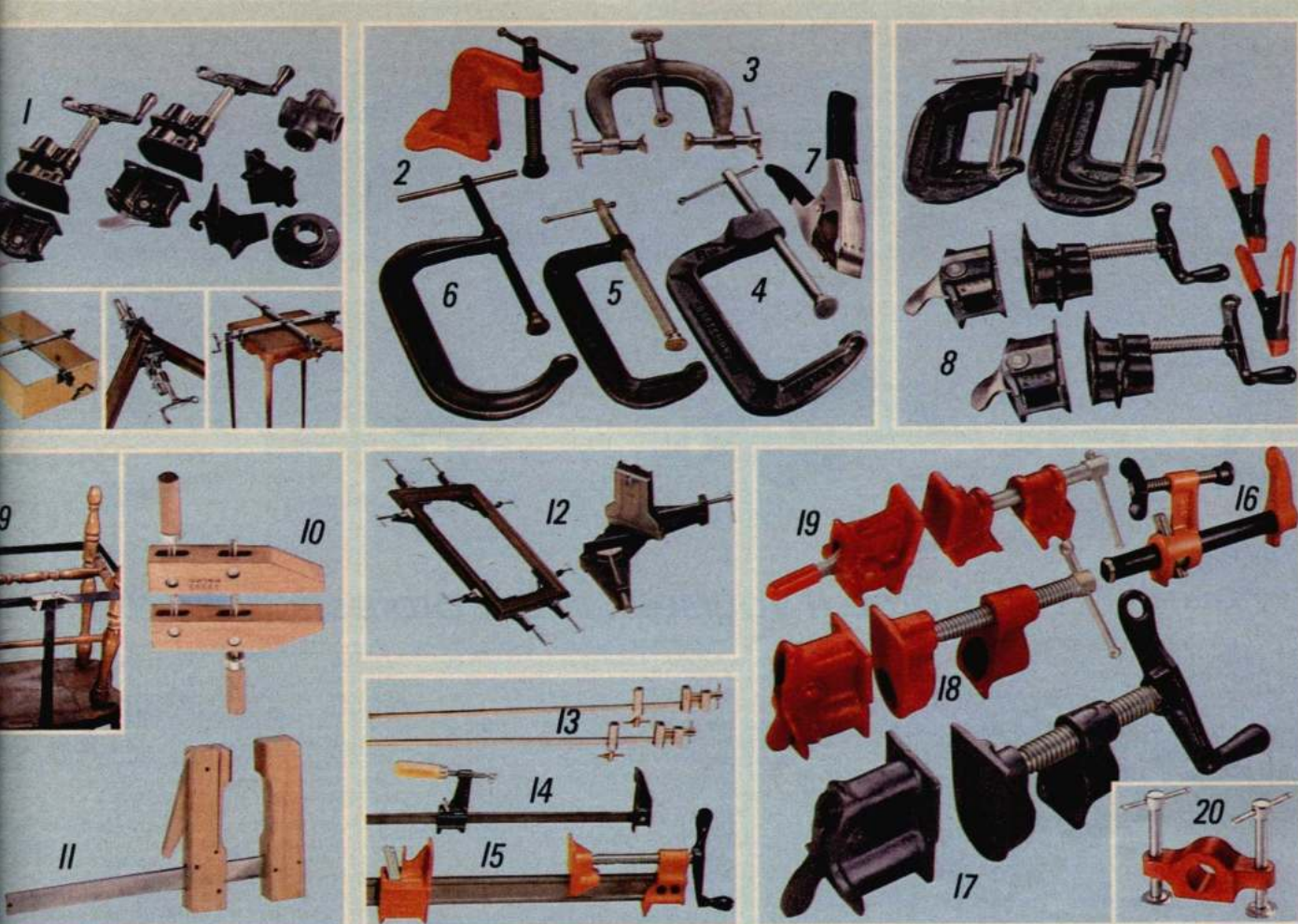

## Quality clamps that hold tight

**1** CRAFTSMAN® Clamping System 5. Incl. two ¾-in. gluing clamps, plastic miter fixture, clamp union, bench flange. Warranted\*.  
 9 R 65994—Shpg. wt. 5 lbs. 14 oz. . . . \$19.99

**9** Hold-down clamp mounts on benches, tables and in "T" slots. Swivels 360°. Opens to 3 in. R 66775—Shpg. wt. 1 lb. 15 oz. . . . \$9.99

**10** CRAFTSMAN 3-way edging clamp uses 3 screws to clamp the edge on counter tops and more. 2½-inch opening, throat. Warranted\*.  
 9 R 66776—Shpg. wt. 1 lb. 3 oz. . . . \$6.49

**4** CRAFTSMAN quick-closing clamps feature positive trigger-action for fast opening and closing, easy thumb operation. Extra throat depth. Ductile iron frame; plated rust-resistant screw and tip, vise-type pin handle. Warranted\*.  
 9 R 65931—4-in. Shpg. wt. 2 lbs. 4 oz. . . . \$9.99  
 9 R 65932—6-in. Shpg. wt. 3 lbs. 8 oz. . . . \$11.99

**5** CRAFTSMAN "C" clamps. Ductile iron frame, plated steel screw, sliding handle. Warranted\*.

Opens to	Throat depth	Catalog No.	Shpg. wt.	Price
1 in.	1 in.	9 R 66721	2 oz.	\$1.29
1½ in.	1½ in.	9 R 66722	3 oz.	1.79
1¾ in.	1¾ in.	9 R 66723	12 oz.	2.79
2 in.	2 in.	9 R 66724	1 lb. 9 oz.	5.49
2½ in.	2½ in.	9 R 66725	2 lbs.	7.49
3 in.	3 in.	9 R 66726	2 lbs. 6 oz.	8.49
3½ in.	3½ in.	9 R 66728	4 lbs. 1 oz.	11.99

**6** Drop-forged "C" clamps with extra-deep throats have high-carbon steel frame with steel swivel.

Opens to	Throat depth	Catalog No.	Shpg. wt.	Price
3 in.	2½ in.	9 R 66761	2 lbs. 1 oz.	\$14.99
4 in.	2¾ in.	9 R 66762	3 lbs. 7 oz.	16.99
6 in.	3 in.	9 R 66763	4 lbs. 13 oz.	21.99
8 in.	4½ in.	9 R 66764	7 lbs. 4 oz.	27.99
10 in.	5½ in.	9 R 66765	10 lbs. 12 oz.	44.99
12 in.	5¾ in.	9 R 66766	12 lbs. 15 oz.	54.99

**7** CRAFTSMAN spring clamps. Zinc-plated steel; vinyl handle-grip. Imported.

Opens to	Length	Catalog No.	Shpg. wt.	Price
4 in.	4 in.	9 R 65942	1 lb.	\$1.49
6 in.	6 in.	9 R 65943	1 lb.	2.79
9 in.	9 in.	9 R 65944	1 lb.	3.99

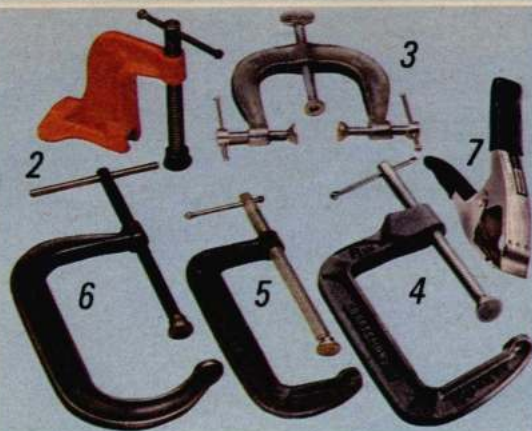

**8** CRAFTSMAN 8-pc. clamp set includes two 1-in. spring clamps, two ¾-in. ductile iron pipe clamps, two 3-in. ductile iron "C" clamps and two 4-in. ductile iron "C" clamps. Warranted\*.  
 9 R 65993—Shpg. wt. 9 lbs. 11 oz. . . . Set \$44.99

**9** CRAFTSMAN band clamp is a 12-ft.x1-in. nylon band with 4 steel corners to protect it from glue and sharp edges. Steel wrench. Warranted\*.  
 9 R 66777—Shpg. wt. 12 oz. . . . \$9.99

**10** CRAFTSMAN adjustable gluing clamps are kiln-dried hardwood with nickel-plated rods. Warranted\*.

Opens to	Catalog No.	Shpg. wt.	Price
2½ in.	9 R 66641	1 lb.	\$11.99
4½ in.	9 R 66642	1 lb. 6 oz.	13.99
6½ in.	9 R 66643	2 lbs. 6 oz.	15.99
8½ in.	9 R 66644	3 lbs. 5 oz.	18.99
10½ in.	9 R 66645	4 lbs. 4 oz.	22.99

**11** Hornbeam gluing clamps are capable of applying 350 lbs. of pressure. Ideal for cabinet gluing. Cork faces. 4¾-in. throat. Imported.

Opens to	Catalog No.	Shpg. wt.	Price
8 in.	9 R 66601	12 oz.	\$5.99
15¾ in.	9 R 65918	1 lb. 5 oz.	6.99
23 in.	9 R 65924C	1 lb. 10 oz.	7.99
32 in.	9 R 65936C	1 lb. 15 oz.	12.99

**12** CRAFTSMAN corner and miter clamp set holds pieces up to 3 in. wide. Incl. 4 corner clamps; 1 miter clamp. Aluminum alloy miter clamp guides your back or hand saw for precise 45° angle cutting.  
 9 R 66625—Shpg. wt. 3 lbs. 9 oz. . . . Set \$27.99

Corner clamp alone. Holds work at 90° angle.  
 9 R 6666—Shpg. wt. 8 oz. . . . \$6.49

Miter clamp alone. Cuts 45° miter and clamps work at 90° angle.  
 9 R 6664—Shpg. wt. 1 lb. 4 oz. . . . \$8.99

**13** Brass "Mini" clamp set for light work. 12 inches long, ¾-inch wide jaws. Set of 2. Imported.  
 9 R 66604—Shpg. wt. 7 oz. . . . Set \$5.99

\*Warranted by Sears, write for free copy, see page 148.



**14** CRAFTSMAN bar clamps for light work have clutch discs to hold anywhere along the bar. 2½-inch reach. Warranted\*.

Opens to	Catalog No.	Shpg. wt.	Price
6 in.	9 R 65991	1 lb. 4 oz.	\$7.49
12 in.	9 R 66767	1 lb. 11 oz.	8.49
18 in.	9 R 65992	2 lbs.	10.99
24 in.	9 R 66768	2 lbs. 5 oz.	11.99
36 in.	9 R 66769C	2 lbs. 14 oz.	13.99

**15** "I"-bar clamps for heavy-duty work have clutch discs to hold anywhere along the bar. 2-inch reach.

Opens to	Catalog Number	Shpg. wt.	Price
24 in.	9 R 66771C	7 lbs. 12 oz.	\$21.99
36 in.	9 R 66772C	9 lbs. 4 oz.	23.99
48 in.	9 R 66773C	10 lbs. 7 oz.	26.99
72 in.	9 R 66774C	13 lbs. 10 oz.	29.99

**16** Deep-reach clamp fixture with steel discs for ¾-in. black pipe can be used as a "C" clamp or a bar clamp. Holds work together or spreads it apart anywhere along the pipe.  
 9 R 66778—Shpg. wt. 2 lbs. 4 oz. . . . \$12.99

**17 and 18** 2-pc. clamp sets of ductile iron are for use with threaded black pipe for extra long work pieces. Smooth jaw faces help protect wood. Imported.

**17** CRAFTSMAN. Fits ¾-in. pipe. Spin-quick handle. 1¾x1¾-in. face. Warranted\*.  
 9 R 6674—Shpg. wt. 2 lbs. 2 oz. . . . Set \$9.99

**18** Fits ½-in. pipe. T-handle. 1¼x½-in. face.  
 9 R 6675—Shpg. wt. 1 lb. 7 oz. . . . Set \$8.49

**19** CRAFTSMAN pipe clamp fits ¼-in. black pipe. Quick-locking cam for easy adjustment. Aluminum alloy face is 1x¾-inch. Warranted\*.  
 9 R 66605—Shpg. wt. 9 oz. . . . \$7.49

Clamp pads (not shown) fit ¼, ½, ¾ inch pipe clamps. Set of 4.  
 9 R 66770—Shpg. wt. 3 oz. . . . Set \$3.79

**20** Center pipe clamp for ½-in. and ¾-in. pipe. Tool clamps center areas of tables or desks. Holds veneer while glue dries. Removable bushing.  
 9 R 65928—Wt. 8 oz. . . . \$5.99

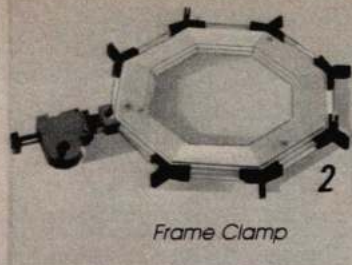

Frame Clamp



Adjustable Framing Clamp



Brad-point Nail



Self-squaring Frame Clamp



Heavy-duty Miter Trimmer is designed for your most exacting projects

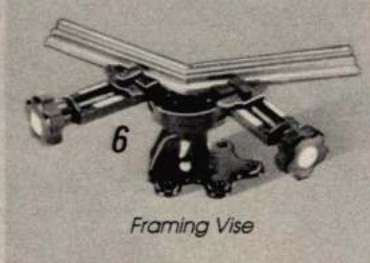

Framing Vise

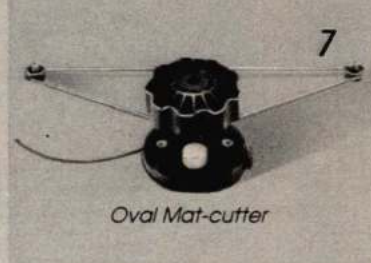

Oval Mat-cutter



Frame Mate

## Frame it yourself . . . the professional way!

**1** This heavy-duty Miter Trimmer features a cutting knife that quickly and accurately makes finished, fitted, beveled, chamfered or square cuts. It eliminates sanding and trimming to fit, and it's excellent for framing. It takes stock up to 4 in. thick for mitering and up to 6 in. wide for squaring. Cuts at any angle from 45° to 90°. The heat-treated tool steel shearing knife measures 3.375x4.10 in. and can be removed for honing. Frame is cast-iron machined. Miter Trimmer can be used as either a permanently placed tool or as portable one. Instructions included.  
9 R 51771C—Shpg. wt. 30 lbs. . . \$269.99

**2** This Frame Clamp holds rectangular, hexagonal, octagonal, round and oval picture frames. The housing and clamping jaws are fiberglass reinforced plastic and each jaw has 3 clamping angles: 22½° octagon; 30° hexagon; 45° rectangle. Strapping is nylon reinforced plastic. Clamping periphery is from 12 in. to 144 in. for rectangular frames.  
9 R 65901—Shpg. wt. 1 lb. . . \$24.99

**3** CRAFTSMAN Aluminum Adjustable Framing Clamp has 4 threaded rods, 4 clamps and wing nuts that adjust from 4x4 to 35x35 in. sq.  
9 R 32054—Shpg. wt. 5 lbs. 1 oz. . . \$21.99

**4** With a simple squeeze of the handle you can set brad points without nicking, marring or cracking the glass or frame. Works with molding up to 3½ in. wide, 1¼ in. deep. Cushioning pad protects edge of frame while squeezing.  
9 R 25165—Shpg. wt. 12 oz. . . \$9.99

**5** Self-squaring Clamp is for any size frame from 5x7 to 26x30 in. (using 1-in. wide molding). Use with brad-point nailer (4). Folds to 4 in. wide for storage.  
9 R 17166—Shpg. wt. 3 lbs. . . \$19.99

**6** This Framing Vise is made of durable cast iron. It tilts 90°, rotates 360° and accepts moldings up to 4 inches wide. Adapts to make 6 and 8-sided frames with up to 2½-inch moldings.  
9 R 51703—Shpg. wt. 14 lbs. 8 oz. . . \$69.99

**7** Available in Catalog only. Oval Mat Cutter makes precise oval and circle cuts from 2x3 in. to 9½x17 in. ½ in. max. depth of cut. 60° bevel cut. Blade lock. Includes 5 blades, 4 pins and instructions.  
9 R 52642—Shpg. wt. 6 oz. . . \$24.99

Available in Catalog only. X-acto® Mat Cutter makes precise straight cuts and professional-looking beveled edge cuts. Blade locks at 45° and 90° angles.  
9 R 52641—Shpg. wt. 13 oz. . . \$8.99

**8** Frame Mate™ is a professional-quality tool that inserts framer's points, push-points and brads into wood frames. The adjustable, magnetic anvil holds and presses points and brads into frame moldings up to 3 in. wide and 1½ in. deep. Rubber cushion protects frame finish. Paper and canvas trimming blades are built into the rear of the handle. 200 straight, flat framer's points included.  
9 R 51775—Shpg. wt. 10 oz. . . \$19.99

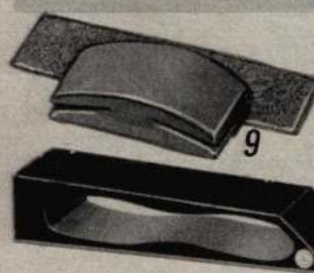

9



10



11



13



Mini-stripper works in curved areas

14



15

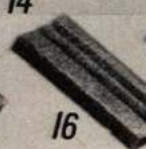

16

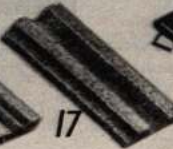

17

### Abrasive accessories



19

**9** CRAFTSMAN 4-pc. Hand-sanding Kit sands wet or dry wood, metal. Incl. solid rubber sanding block, 3 sanding sheets; 1 ea. fine, med., coarse. Imported.  
9 R 36845—Shpg. wt. 14 oz. . . Kit \$3.99

**10** Pressure-sensitive Cement holds sanding discs to metal plates . . . stays tacky to remove after use. 8-oz. bottle.  
9 R 2220—Shpg. wt. 9 oz. . . Bottle \$2.49

**11** CRAFTSMAN Carbide Sanding Block sands wood, plastic, fiberglass; edges glass, porcelain. Tungsten carbide grits brazed to steel . . . outlast standard sanding sheets. Extra sanding sheets sold below.  
9 R 36847—Shpg. wt. 4 oz. . . \$2.99

Extra Sanding Sheets (not shown) for (11). Tungsten carbide brazed to steel. Pkg. of one.  
9 R 36848—Fine grit  
9 R 36849—Medium/coarse grit  
Shpg. wt. 1 oz. . . Ea. \$1.79

**12** Belt Plane's wedge shape lets you sand the tightest areas. Planes or sands wood, aluminum, plastic, glass and more. Hollow grip protects fingers and reduces effort. Use cloth-backed 3x21-in. belts (one included).  
9 R 11221—Shpg. wt. 1 lb. 6 oz. . . \$9.99

**78** \*See "N" suffix, page 148.

**13** Shop Sanding Rolls. 1½ in. wide by 50 yds. long

Grit	Grit No.	Catalog Number	Shpg. wt.		Price
			lbs.	oz.	
Aluminum-oxide					
Coarse	80	9 R 67824	2	6	\$15.99
Medium	120	9 R 67825	2	7	15.99
Fine	180	9 R 67826	1	14	15.99
Emery					
Coarse	80	9 R 67827	2	15	\$15.99
Medium	100	9 R 67828	2	5	15.99
Fine	180	9 R 67829	1	13	15.99

Trigger Oiler cans (not shown).  
9 R 55827—12-oz. capacity. Wt. 8 oz. . . \$3.89  
9 R 55826—6-oz. capacity. Wt. 5 oz. . . \$2.89  
Lubricants (not shown) keep tools in "like new" condition.

1-qt. bottle of Machine Oil  
9 R 55941—Shpg. wt. 2 lbs. 3 oz. . . \$2.89

4-oz. can of Penetrating Oil  
9 R 5593—Shipping weight 7 ounces . . . 69c

4½-oz. Silicone Spray  
9 R 55763—Shipping weight 7 ounces . . . \$1.39

WD-40 All-purpose Lubricant  
9 R 55777—9-oz. spray. Shpg. wt. 13 oz. . . \$1.49  
9 R 55784—12-oz. spray. Shpg. wt. 1 lb. . . \$2.09  
9 R 55782N—1-gal. bottle. Wt. 7 lbs. 7 oz. . . \$12.99

Refillable Sprayer for WD-40. Empty. 1-pt. capacity.  
9 R 55786—Shpg. wt. 6 oz. . . \$2.99

**14** Strip 'n sand Mini-stripper Kit incl. 5 flexible wheels (2 fine, 2 medium, 1 coarse) plus quick-change mandrel and shank. Use on wood, metal, plastic. Fits ¼, ⅜, ½-in. drills.  
9 R 6488—Shpg. wt. 1 lb. 4 oz. . . Kit \$16.99

**15 thru 17** Finish-sand Routed Shapes with specially formed abrasives. Sand up to 80 linear feet of shaped edges. Use only with 9-1066 pad sander or kit (9).

Shape	Sizes	Catalog No.	Wt.	Price
(15) Ogee	¼, ⅜, ½, ¾	9 R 25375	1 oz.	\$5.49
(16) Cove	¼, ⅜, ½	9 R 25376	1 oz.	5.49
(17) Bead	¼-round	9 R 25377	1 oz.	5.49

**18** Utilize Platen Assembly to attach/detach abrasive onto ½ to 20 threaded shaft. Expandable rubber drum. Includes medium grit sleeve. Extra sanding sleeves sold below. Work arbor 9-24645 sold p. 129.  
9 R 25246—Shpg. wt. 15 oz. . . \$9.99

**19** Sanding Drum, 3-in. face, 2¼-in. diam. Screws onto ½ to 20 threaded shaft. Expandable rubber drum. Includes medium grit sleeve. Extra sanding sleeves sold below. Work arbor 9-24645 sold p. 129.  
9 R 25246—Shpg. wt. 15 oz. . . \$9.99  
Sanding Sleeves (not shown) for drum (19). Pkg. of 1  
9 R 25221—Fine grit. Wt. 1 oz. . . Ea. \$1.39  
9 R 25222—Medium grit. Wt. 1 oz. . . Ea. \$1.39  
9 R 25223—Coarse grit. Wt. 1 oz. . . Ea. \$1.39

# Sanding and Abrasive Center

... your one-stop shop for the best in quality abrasives



2



Sanding Discs



Abrasive Cleaner



Sanding Belts

6

## Sanding Sheets

Sanding Sheets for Pad Sanders

Size in.	Grit	Grit No.	Catalog Number	Wt. oz.	Price Pkg.
Aluminum Oxide with paper backing. Pkg. of 6 (except X-coarse, pkg. of 5)					
3/4x9	Fine	320	9 R 25311	1	\$1.39
3/4x9	Medium	180	9 R 25312	1	1.39
3/4x9	Coarse	80	9 R 25313	2	1.39
3/4x9	X-Coarse	50	9 R 25314	2	1.39
4 1/2x11	Fine	320	9 R 25315	1	1.49
4 1/2x11	Medium	180	9 R 25316	2	1.49
4 1/2x11	Coarse	80	9 R 25317	2	1.49
4 1/2x11	X-Coarse	50	9 R 25318	4	1.49
Tungsten Carbide with steel backing for concrete, metal and wood. Pkg. of 1					
3/4x9	Fine		9 R 30284	2	\$2.29
3/4x9	Medium		9 R 30285	2	2.29
3/4x9	Coarse		9 R 30286	2	2.29
4 1/2x11	Fine		9 R 30096	3	3.19
4 1/2x11	Medium		9 R 30097	3	3.19
4 1/2x11	Coarse		9 R 30098	3	3.19

2 Nonloading Zinc Stearate Sheets, Fine grit, silicon carbide; medium, coarse grits, aluminum-oxide.

Size in.	Grit	Grit No.	Catalog Number	Wt. oz.	Price Pkg.
Paper backed. Package of 6.					
3/4x9	Fine	180	9 R 25331	1	\$1.69
3/4x9	Medium	80	9 R 25332	2	1.69
3/4x9	Coarse	50	9 R 25333	3	1.69
4 1/2x11	Fine	180	9 R 25335	2	1.99
4 1/2x11	Medium	80	9 R 25336	3	1.99
4 1/2x11	Coarse	50	9 R 25337	4	1.99
Pressure-sensitive adhesive, paper backed. Package of 5.					
3/4x7 1/4	Fine	180	9 R 25365	1	\$2.49
3/4x7 1/4	Medium	80	9 R 25366	2	2.49
3/4x7 1/4	Coarse	50	9 R 25367	3	2.49
4 1/2x9 1/4	Fine	180	9 R 25351	2	2.39
4 1/2x9 1/4	Medium	80	9 R 25352	3	2.39
4 1/2x9 1/4	Coarse	50	9 R 25353	4	2.39

## Hand Sanding Sheets

You can also cut them to fit pad sanders. 9x11 inches.

Sheet type	Grit	Grit No.	Catalog Number	Wt. lbs. oz.	Price
Aluminum Oxide is paper-backed for hand-wood					
	X-fine*	150	9 R 27421	3 15	\$19.99
	Fine*	100	9 R 27422	4 8	19.99
	Med. Δ	60	9 R 27425	4	14.99
	Coarse Δ	40	9 R 27424	3 7	16.99
Garnet paper for all woods					
	X-Fine*	150	9 R 67941	4 12	18.59
	Fine*	100	9 R 67942	6	18.59
	Med. Δ	60	9 R 67949	4 11	12.49
	Coarse Δ	40	9 R 67944	7	14.59
Emery cloth for metal					
	Fine Δ		9 R 67925	4	24.99
	Med. Δ		9 R 67926	4 4	24.99
	Coarse Δ		9 R 67927	5 8	24.99
Silicon Carbide Water-sand Finishing paper					
	Super-Fine*	400	9 R 30121	2 8	24.99
	X-Fine*	320	9 R 30122	2 10	24.99
	Med. Fine*	240	9 R 30123	3 2	24.99

\*Pkg. of 100. ΔPkg. of 50

SearsCharge and Discover Card... each is different, but together they're all you really need

To apply for SearsCharge only CALL TOLL FREE 1-800-323-3274 IN ILLINOIS CALL 1-800-942-7446

## Sanding Discs

Aluminum Oxide Sanding Discs fit portable and bench sanders.

Diam. in.	Hole	Grit	Pkg. of	Catalog Number	Wt. lbs. oz.	Price pkg	
Paper-backed							
5	None	X-Fine (No. 220)	6	9 R 26051	1	\$1.69	
		Fine (No. 120)	6	9 R 26052	1	1.69	
		M-Fine (No. 80)	6	9 R 26053	1	1.69	
5	1/4 in.	Coarse (No. 36)	3	9 R 2542	2	1.49	
		Asstd.†† (No. 120, 60)	6	9 R 2543	2	1.89	
6	None	X-Fine (No. 220)	6	9 R 25257	1	1.89	
		Fine (No. 120)	6	9 R 25258	2	1.89	
		Med. Fine (No. 80)	6	9 R 25259	2	1.89	
6	1/4 in.	Fine (No. 100)	6	9 R 25321	3	2.29	
		Med. (No. 60)	6	9 R 25322	4	2.29	
		Coarse (No. 40) Asstd.† (No. 100, 60, 40)	4	9 R 25323	3	2.29	
6	3/8 in.	Fine (No. 80)	6	9 R 25325	4	2.29	
		Med. (No. 50)	6	9 R 25293	3	2.29	
		Coarse (No. 36)	6	9 R 25294	4	2.29	
8	None	Asst.† (Fine, Med., Coarse)	6	9 R 27233	10	2.99	
8	3 in.	Asst.† (Fine, Med., Coarse)	6	9 R 27232	10	2.79	
9	None	Fine (No. 120)	6	9 R 25301	6	3.19	
		Med. (No. 60)	6	9 R 25302	9	3.19	
		Coarse (No. 40)	5	9 R 25303	10	3.19	
10	3 in.	Asst.† (No. 120, 60, 40)	6	9 R 27231	11	3.89	

## Pressure-sensitive Adhesive Discs

Zinc Stearate pressure-sensitive adhesive, paper backing

Diam. in.	Hole	Grit	Pkg. of	Catalog Number	Wt. lbs. oz.	Price pkg	
5	None	Fine (No. 120)	5	9 R 30051	1	\$2.69	
		Medium (No. 80)	5	9 R 30052	1	2.69	
		Coarse (No. 40)	4	9 R 30053	1	2.69	
6	None	X-Fine (No. 220)	6	9 R 25247	1	2.99	
		Fine (No. 120)	6	9 R 25248	1	2.99	
		Med-Fine (No. 80)	6	9 R 25249	2	2.99	
8	None	Asst.† (Fine, Med., Coarse)	6	9 R 27245	10	3.99	
8	3 in.	Asst.† (Fine, Med., Coarse)	6	9 R 27235	10	3.99	

Pressure-sensitive adhesive; paper backed

Diam. in.	Hole	Grit	Pkg. of	Catalog Number	Wt. lbs. oz.	Price pkg	
9	None	Fine (No. 120)	5	9 R 30061	5	\$5.49	
		Medium (No. 60)	5	9 R 30062	8	5.49	
		Coarse (No. 40)	5	9 R 30063	10	5.49	
10	3 in.	Asst.† (Fine, Med., Coarse)	6	9 R 27225	11	4.99	

Pressure-sensitive Adhesive Discs—cloth backed

Diam. in.	Hole	Grit	Pkg. of	Catalog Number	Wt. lbs. oz.	Price pkg
6	None	X-Fine (No. 240)	3	9 R 32075	2	\$2.89
		Fine (No. 150)	3	9 R 32076	2	2.89

Fiber-backed... wear longer than discs above

Diam. in.	Hole	Grit	Pkg. of	Catalog Number	Wt. lbs. oz.	Price pkg	
6	1/2 in.	Medium (No. 50)	10	9 R 25297	12	\$7.99	
		Fine (No. 80)	10	9 R 25299	1	8.69	
		Medium (No. 50)	10	9 R 25291	1	3 9.39	
7	1/2 in.	Coarse (No. 36)	10	9 R 25292	2	9.79	
		Fine (No. 80)	10	9 R 25287	10	12.79	
		Medium (No. 50)	10	9 R 25288	1	15 13.49	
9 1/4	1/2 in.	Coarse (No. 36)	10	9 R 25289	2	13.99	

†2 fine, 2 medium and 2 coarse ††3 fine and 3 coarse

3 Tungsten carbide sanding discs... bonded to thin steel. Fit portable, bench sanders.

Diam. in.	Hole in.	Grit type	Pkg. of	Catalog Number	Wt. oz.	Price each
5	1/4, 3/8	medium	1	9 R 30091	2	\$2.29
		coarse	1	9 R 30092	2	2.29
6		medium	1	9 R 30093	2	2.29
		coarse	1	9 R 30094	2	2.29
5	1/4, 3/8	X-coarse	1	9 R 30095	2	2.29
		X-coarse	1	9 R 30099	3	2.59

## Abrasive Cleaner

4 Perfect for unclogging loaded belts or discs. 1 1/2x1 1/2x4 1/4-in. cleaning stick removes sanding residue.

9 R 22744—Shpg. wt. 5 oz... \$2.49

## Sanding Belts

Our large assortment of styles, grits, sizes gives just the finish you want for machine or hand sanding. Aluminum oxide is best for sanding wood and plastic. Zinc stearate coating has non-clogging properties that increase wear. Add polyester backing for a sanding belt that resists tearing, fraying, moisture better than any other belt we sell. Steel-backed tungsten carbide will sand concrete, metal... even plane wood!

5 CRAFTSMAN polyester-backed aluminum-oxide sanding belts last 3-5 times longer than cloth-backed. For wood, plastic.

Size in.	Grit		Catalog Number	Wt. oz.	Price each
	No.	Type			
3x21	100	X-fine	9 R 23201	1	\$2.29
	80	fine	9 R 23202	1	2.29
	50	medium	9 R 23203	1	2.29
	36	coarse	9 R 23204	2	2.29
4x21	100	X-fine	9 R 23209	2	2.99
	80	fine	9 R 23210	2	2.99
	50	medium	9 R 23211	2	2.99
	36	coarse	9 R 23212	3	2.99
4x24	100	X-fine	9 R 27464	2	3.29
	80	fine	9 R 27465	2	3.29
	50	medium	9 R 27466	3	3.29
	36	coarse	9 R 27467	3	3.29
6x48	80	fine	9 R 27474	6	6.29
	50	medium	9 R 27475	8	6.29
	36	coarse	9 R 27476	13	6.29

6 Sears cloth-back sanding belts are of aluminum oxide abrasive for portable or bench-type sanders on wood and metal.

Size in.	Grit		Catalog Number	Wt. oz.	Price each
	No.	Type			
2 1/2x16	100	X-fine	9 R 22396	1	\$1.49
	80	fine	9 R 22397	1	1.49
	50	medium	9 R 22398	1	1.49
	36	coarse	9 R 22399	1	1.49
3x21	100	X-fine	9 R 22304	1	1.99
	80	fine	9 R 22301	1	1.99
	50	medium	9 R 22302	1	1.99
	36	coarse	9 R 22303	2	1.99
3x21	16	X-coarse	9 R 22305	2	1.99
	80	fine	9 R 22311	1	2.19
	50	medium	9 R 22312	2	2.19
	36	coarse	9 R 22313	2	2.19
4x21	100	X-fine	9 R 25220	2	2.39
	80	fine	9 R 25224	2	2.39
	50	medium	9 R 25225	2	2.39
	36	coarse	9 R 25226	3	2.39
4x21 1/2	80	fine	9 R 22321	2	2.69
	50	medium	9 R 22322	2	2.69
	36	coarse	9 R 22323	3	2.69
	100	X-fine	9 R 22332	1	2.39
4x24	80	fine	9 R 22333	2	2.39
	50	medium	9 R 22334	2	2.39
	36	coarse	9 R 22335	3	2.39
	16	X-coarse	9 R 22336	3	2.39
4x36	100	fine	9 R 22151	2	2.69
	80	med.-fine	9 R 22150	3	2.69
	60	medium	9 R 22152	3	2.69
	40	coarse	9 R 22153	4	2.69
4x60	80	fine	9 R 21661	3	3.19
	50	medium	9 R		

\$37<sup>99</sup>

**CRAFTSMAN electric Brad Nailer has a special base design for corners and crevices ... drives and countersinks in one step**

Penetrates most surfaces except some hardwoods and particle boards. Holds 1 and 1 1/2-in. brad nails. Touch-activated safety lock deters accidental discharges. Quick release clears jams in nose. No mar vinyl base. Solid state high-impact housing. UL listed AC. 6-in., 3-wire cord. Warranted by Sears, write for free copy, see p. 148. Wt. 3 lbs. 4 oz. 9 R 68425...\$37.99



Easy one-hand operation

Fastens in areas hammers can't reach

V-base fits panel-grooves and corners

**Staples and Brad Nails Warranted\* ... see below, right.**

5/16-in. staples for (5) below. Package of 1000. 9 R 74463—Wt. 2 oz. ... Pkg. \$1.49

Staples fit all staplers on this page except for 9-6848. .050 steel, 1/2-in. wide. Package of 5000 staples.

Save 10% when you buy any 3 or more pkgs.

Lgth. in.	Catalog Number	Wt. lbs. oz.	Price Pkg	Ea. pkg.
1/4	9 R 74452	1 3	\$6.99	\$6.29
5/16	9 R 74453	1 6	7.49	6.74
3/8	9 R 74454	1 9	7.99	7.19
1/2	9 R 74456	1 14	8.99	8.09
5/8	9 R 74457	2 4	10.49	9.44

Brad nails for (1) at left. 18-ga. Woodtone color or off-white. Pkg. of 500 nails.

Save 10% when you buy any 3 or more pkgs.

Lgth.	Color	Catalog Number	Wt. Pkg	Pkg	Ea. pkg.
1 in.	Lt.	9 R 68453	7 oz.	\$1.89	\$1.70
1 in.	Med.	9 R 68454	7 oz.	1.89	1.70
1 in.	Dark	9 R 68455	7 oz.	1.89	1.70
1 in.	Off-white	9 R 68452	7 oz.	1.89	1.70
1 1/4 in.	Lt.	9 R 68457	8 oz.	1.99	1.79
1 1/4 in.	Med.	9 R 68458	8 oz.	1.99	1.79
1 1/4 in.	Dark	9 R 68459	8 oz.	1.99	1.79
1 1/4 in.	Off-white	9 R 68456	8 oz.	1.99	1.79

Brad nails for (2) below in light brown or dark brown. Package of 500.

Lgth.	Nail shade	Catalog Number	Wt. oz.	Pr. pkg.
1/2 in.	Light	9 R 68472	2	\$1.49
1/2 in.	Dark	9 R 68473	2	1.49
3/8 in.	Light	9 R 68474	2	1.49
3/8 in.	Dark	9 R 68475	2	1.49



**CRAFTSMAN Stapler/Nailer may be used as a brad nailer or a stapler**

\$27<sup>99</sup>

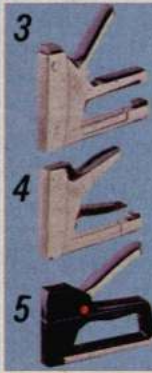

**CRAFTSMAN Heavy-duty, dual-power Stapler \$18<sup>99</sup>**

**CRAFTSMAN Heavy-duty, single-power Stapler \$13<sup>99</sup>**

**Sears standard duty Stapler \$7<sup>49</sup>**

2 Stapler/Nailer does the work of two units in one. Uses 5 staple sizes and 2 sizes of brad nails. Dual power allows deep penetration for hard materials on high, helps prevent staples or nails from going thru thin materials on low. Easy-loading, swing-away base design allows flush finishing within 1/8-in. of vertical surfaces. Lexan® plastic housing. UL listed AC. Warranted\*. 9 R 68471—Shipping weight 2 pounds...\$27.99

3 Heavy-duty dual-power manual stapler switches from regular to high power at a push of a button for extra-tough fastening jobs. Nickel-plated steel construction with built-in staple remover. Steel-plated bottom slides open for quick reloads. Warranted\*. 9 R 6843—Shpg. wt. 1 lb. 13 oz. ...\$18.99

4 Heavy-duty single-power stapler. Same construction features as above. Pistol grip handle. Warranted\*. 9 R 6846—Shpg. wt. 1 lb. 10 oz. ...\$13.99

5 Standard-duty manual stapler has swing-open steel-plated bottom for easy reloading. One-hand handle release lock. Built-in staple extractor. Lexan® plastic housing. Not Craftsman. 9 R 6848—Shpg. wt. 10 oz. ...\$7.49 \*Warranted by Sears, write for free copy, see page 148.

**Industrial quality trigger-operated Power Hammer delivers powerful blow for attaching materials without drilling**



CRAFTSMAN® Power Hammer forms secure attachments with one powerful blow

\$34<sup>99</sup>

\$129<sup>99</sup>

7 Available in Catalog only. Industrial-quality power hammer. Select proper load and fastener from chart below. Pull trigger for quick results! Hardened steel. High-impact plastic handle, comfort grip. UL listed. Incl. lockable case. Warranted\* ... below, right. See safety note below. 9 R 38202—Wt. 10 lbs. 15 oz. ...\$129.99

Fasteners for power hammers. Box of 100.

Size	Catalog No.	Shpg. wt.	Price, box
3/4 in.	9 R 38175	8 oz.	\$7.99
1 in.	9 R 38176	10 oz.	8.99
1 1/4 in.	9 R 38177	12 oz.	9.99
1 1/2 in.	9 R 38178	14 oz.	12.99
2 in.	9 R 38179	1 lb. 2 oz.	13.99
2 1/2 in.	9 R 38181	1 lb. 6 oz.	14.99

Application	Power Load	Fastener
2x4 wood to cement block	9 R 38172	9 R 38181
2x4 wood to concrete	9 R 38173	9 R 38181
1 in. plywood to concrete	9 R 38173	9 R 38179
1x2 wood furring to cement block	9 R 38172	9 R 38178
Awnings/Shutters to horizontal mortar joint	9 R 38171	9 R 38178
1x2 wood furring to concrete	9 R 38173	9 R 38178
1x2 wood furring to 1/2-in. steel	9 R 38173	9 R 38177
Elec. Box/Mailbox to cement block	9 R 38173	9 R 38176
Shell Bracket/Elec. box to concrete	9 R 38173	9 R 38176
Mailbox/Furring to cinder block	9 R 38171	9 R 38178
Elec. box/Conduit clip to concrete	9 R 38172	9 R 38175
Elec. box to 1/2-in. steel	9 R 38173	9 R 38175

CRAFTSMAN Two-in-One Riveter can be used straight or at right angles ... gets into hard-to-reach areas \$18<sup>99</sup>

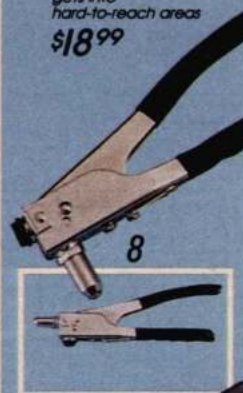

8 CRAFTSMAN Two-in-one riveter can be used either straight or in right angle position. Lets you reach tight areas. Includes 3 interchangeable nosepieces for 1/8, 5/32 and 3/16-inch diameter rivets. Plastisol grips, steel construction. Instructions included. Warranted\*. Wt. 1 lb. 5 oz. 9 R 74747...\$18.99

9 CRAFTSMAN Right-angle riveter has same features and construction as (8) above. Warranted\* 9 R 7473—Shpg. wt. 1 lb. ...\$13.99

10 Standard-duty riveter takes 1/8-inch diameter steel and aluminum and 5/32-inch diameter aluminum rivets. Nickel-plated finish. Plastic grips. 9 R 74719—Shpg. wt. 1 lb. ...\$7.49

1/8-inch diameter rivets for riveters.

Length	Package of	Catalog Number	Wt.	Pkg.
<b>Aluminum Rivets</b>				
1/8 inch	200	9 R 74521	3 oz.	\$6.99
1/4 inch	200	9 R 74522	4 oz.	6.99
<b>Steel Rivets</b>				
1/8 inch	200	9 R 74527	8 oz.	\$6.99
1/4 inch	200	9 R 74528	10 oz.	6.99

Available in Catalog only. Rivet dispenser and rivet assortment (not shown). Dispenser conveniently stores 6 different types of rivets in 1 place. Eliminates need to sift thru piles of rivets to find the proper size. Incl. 1/8x1/8, 1/4x1/8, 1/4x3/32, 3/8x5/32 in. aluminum rivets, 1/8x1/8, 3/8x1/8 in. steel rivets in clear top dispenser. 9 R 74614—Shpg. wt. 10 oz. ...\$9.99

\*Warranted by Sears, write for free copy, see p. 148.

6 Available in Catalog only. CRAFTSMAN power hammer. Select proper load and fastener from chart below, right. Hardened steel with high-impact plastic handle and comfort grip. UL listed. Safety note below. Wt. 2 lbs. 10 oz. 9 R 3817...\$34.99

Power loads. Box of 100. "N" note, p. 326A.

Strength	Catalog No.	Shpg. wt.	Box
Light	9 R 38171N	3 oz.	\$8.99
Medium	9 R 38172N	3 oz.	8.99
Heavy	9 R 38173N	4 oz.	8.99
X-heavy	9 R 38174N	4 oz.	8.99

Back-up discs help control the depth of power hammer fasteners. Box of 100. 9 R 38182—Wt. 1 lb. 4 oz. ... Box \$5.99

Safety Note: Safety goggles and hearing protection are strongly recommended when using Power Hammers (6 and 7).

# Handy helpers add convenience



## Canvas Work Aprons

1 Carpenters' bib-style cotton canvas work apron has 14 convenient pockets. Made in USA. 9 R 3750—Wt. 11 oz. . . \$6.99

2 Waist-style cotton canvas apron has 10 pockets and 2 tool loops. Made in USA. 9 R 3751—Wt. 5 oz. . . \$5.99



New at Sears!  
Comfortable  
Kneeling Cushion

## Kneeling Cushion, Knee Pads and Caps make the job more comfortable

3 Soft, yet rugged kneeling cushion helps you work on your knees in comfort. Made of durable polyurethane foam. Handy carry-handle. 16 in. Lx7 in. W. Shipping weight 4 ounces. 9 R 37661 . . . \$3.44

4 New at Sears! Rugged plastic knee caps give knee protection and add comfort. Combined with cellular rubber. Elastic straps, Velcro® fasteners for the fit you want. Shipping weight pair 1 pound. 9 R 37665 . . . Pair \$17.88  
®Reg. Trademark

5 Rubber knee pads adjust to fit. Made of ½-in. thick natural cellular rubber. Shipping weight pair 8 ounces. 9 R 3766 . . . Pair \$5.49

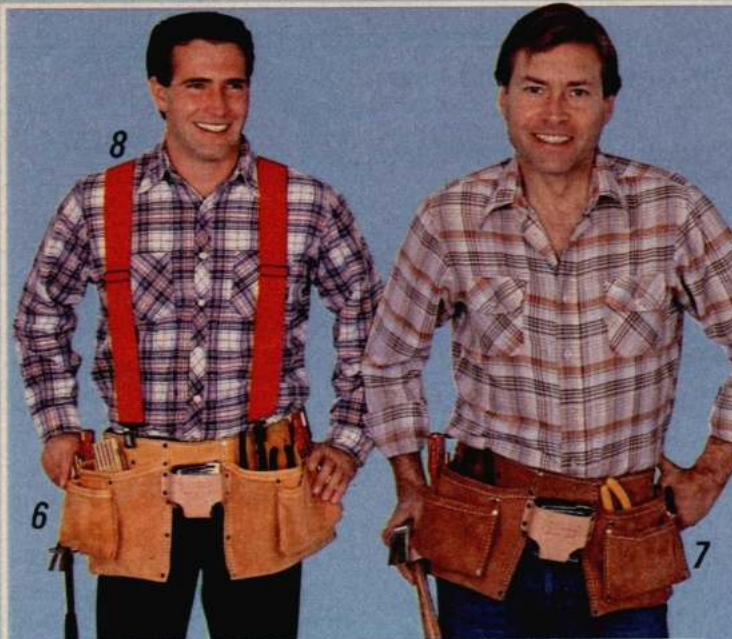

**CRAFTSMAN Work Aprons with hand tool holders and pockets keep work right at hand. Top grain leather or sueded cowhide leather**

**\$14.99 and up**

6 and 7 CRAFTSMAN work aprons are reinforced at stress points.

Type of leather	(6) Top-grain leather	(6) Sueded Cowhide leather	(7) Sueded Cowhide leather
Catalog No. . . . .	9 R 45147	9 R 45145	9 R 45042
Pockets . . . . .	10 pockets . . . 2 extra large, 2 medium, 6 for small tools and accessories		8 pockets . . . 2 med., 2 small, 4 small tool
Belt size . . . . .	Fully adjustable 2¼-in. wide polypropylene web-style belt. Fits waists 29 to 46 inches		1¾-in. wide polypropylene belt. Fits waists 29 to 46-in.
Shpg. wt. . . . .	2 lbs. 4 oz.	1 lb. 12 oz.	1 lb. 2 oz.
Price . . . . .	\$33.99	\$27.99	\$14.99

## Work Suspenders

8 Extra-heavy-duty work suspenders are adjustable. Made of polypropylene with elastic webbing for long life and comfort. 9 R 45061—Shipping weight 1 pound . . . \$8.99



## Construction workers' all-leather Side Bags

9 thru 12 Professional bags feature the partitions and pockets needed to hold your special tools, nails and other equipment. All have 3-inch tunnel-style belt loop.

Type of leather	(9) Top-grain leather	(10) Sueded cowhide leather	(11) Top-grain leather	(12) Sueded cowhide leather
Catalog No. . . . .	9 R 45143	9 R 45137	9 R 45136	9 R 45135
No. of pockets . . . . .	8 pockets . . . 1 large, 1 medium, 6 small tool and accessory		9 pockets . . . 1 large, 2 med., 6 small tool and acc.	
Shpg. wt. . . . .	1 lb.	13 oz.	15 oz.	15 oz.
Price . . . . .	\$19.99	\$15.49	\$23.99	\$19.49



## Hammer Holder and Tape Pocket

13 Two-inch steel cradle loop hammer holder fits belts to 2¾ inches wide. Shpg. wt. 4 oz. 9 R 4585 . . . \$2.79

14 Tape pocket holds one-inch wide tapes up to 25 feet long. Shpg. wt. 5 oz. 9 R 4515 . . . \$5.99

Need a special hammer?  
See page 84 for hammers to suit most every need

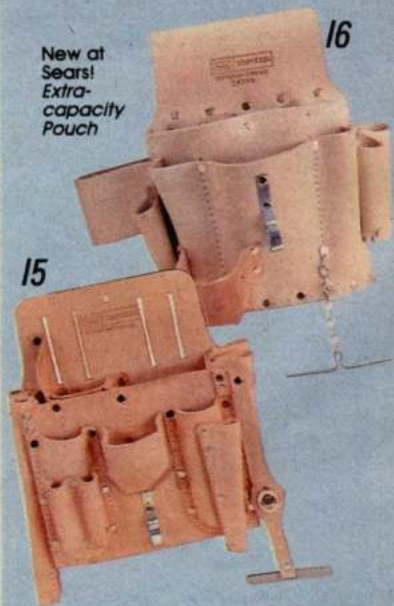

## Professional electrician and maintenance workers' Leather Pouches

15 Glove leather nail and tool bag is soft, pliable, yet rugged. 11 molded pockets. Riveted and stitched for long life. 10x12 in. 9 R 45157—Wt. 1 lb. 6 oz. . . \$29.99

16 Heavy-duty leather tool-holder has 5 pockets . . . 2 main, 3 flared front pockets, tape pocket, side loop, quick release snap. Stitched and rivet-reinforced for long service. 10x12 in. 9 R 4580—Shpg. wt. 15 oz. . . \$17.99



17 Heavy-duty Cotton Web Belt is 2¼ inches wide. Adjustable. 9 R 45895—Shpg. wt. 8 oz. . . \$4.99

18 Extra heavy-duty leather belt. Gives back and hips maximum support. 3-in. wide belt tapers to 2 inches at stomach area for comfort. Waist 29 to 36 in. Wt. 10 oz. 9 R 45897 . . . \$9.49  
Waist 38 to 46 in. Wt. 13 oz. 9 R 45898 . . . \$9.99

# For accuracy you can rely on, trust CRAFTSMAN® tapes



## Posilock® measuring tapes

- ✓ Locking button keeps tape from slipping for more accurate measurements
- ✓ Power blade return for easy retrieval
- ✓ Tough tip blade protector keeps tip extra secure from forceful pulling and tugging
- ✓ Sliding service door makes it easy to replace broken tape
- ✓ Durable chrome-plated ABS plastic case for years of service

Tough tip keeps tip secure

Posilock® tapes gives you an extra measure of protection at the tip of the tape where its needed most. Repl. blades sold at right. Warranted by Sears, write for free copy, p. 148.

Tape Width	Tape Length	Catalog Number	Wt. lbs.	Price
1-in.	20-ft.	9 R 39415	14	\$12.99
1-in.	25-ft.	9 R 39416	1	14.99
3/4-in.	12-ft.	9 R 39411	6	9.99
3/4-in.	16-ft.	9 R 39412	10	11.99
3/4-in.	20-ft.	9 R 39413	11	12.99
3/4-in.	25-ft.	9 R 39414	13	13.99

Tape similar to (1) except no service door or auto rewind. 12-ft. long, 1/2 in. wide. 9-39406 also has metric scale. 9 R 39405—Shpg. wt. 5 oz. . . \$8.49  
9 R 39406—Shpg. wt. 5 oz. . . 8.99

**2** Square tape measures and squares at the same time. Lock keeps blade in place while you hook back ledge on work surface and draw square line. 16 ft. x 3/4-in. tough-tip blade. Belt clip. Warranted by Sears. Write for free copy, page 148.  
9 R 39420—Wt. 9 oz. . . \$11.99

CRAFTSMAN square tape measures and squares at the same time

CRAFTSMAN Doweling Equipment

Helps align and join wood for professional looking results

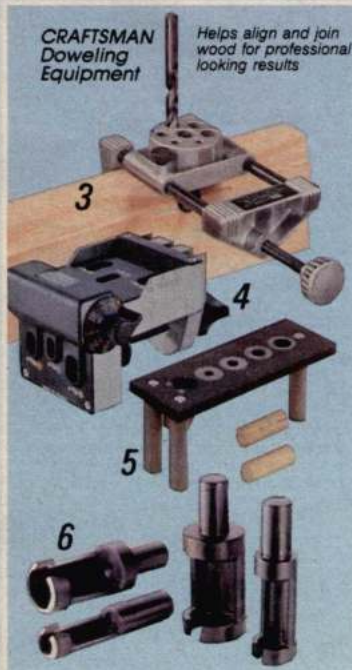

**3** CRAFTSMAN doweling jig allows straight drilling, precision alignment of holes for joining wood with dowel rods. Holes for 3/16 thru 1/2-in. drill bits. 4-in. capacity. Revolving turret. 6 1/4 x 3 x 2 3/4 in. 9 R 4186—Wt. 2 lbs. 3 oz. . . \$21.49

**4** CRAFTSMAN dial-setting doweling jig produces precise right angle and T-shaped joints. Set dial for stock thickness; jig selects proper dowel size and positions on both boards. 1/4, 3/8, 1/2-inch diameter capacity dowel holes. Imported. 9 R 67186—Wt. 1 lb. 5 oz. . . \$34.99

**5** CRAFTSMAN dower former and chamfering tool. Flutes, chamfers 1/4, 3/8, 1/2-in. dowels. Incl. replaceable chamfer blade, forming dies. 9 R 41841—Wt. 1 lb. 8 oz. . . \$12.99

**6** CRAFTSMAN self-extracting wood plug cutters for wood to 3/4 inch thick.

Cutter size	Hole diam.	Catalog Number	Wt. oz.	Price
1/4-in.	3/8-in.	9 R 67159	1	\$4.49
3/8-in.	1/2-in.	9 R 67164	1	4.49
1/2-in.	3/4-in.	9 R 67165	1	4.49
3/4-in.	3/4-in.	9 R 67166	2	4.49

4-pc. set incl. all 4 cutters in (6). 9 R 67172—Wt. 3 oz. . . \$15.99

**7** CRAFTSMAN V-block and clamp set holds up to 1-in. round or irregular-shaped material. 2 clamps, 2 V-blocks incl. Warranted by Sears, write for free copy, see p. 148.  
9 R 4083—Wt. 1 lb. 9 oz. . . \$29.99

CRAFTSMAN V-Block and clamp set is precision-ground for accuracy



**8 thru 10** Warranted by Sears, write for free copy, see p. 148.

**8** Push/pull tape is 8 ft. long, 1/4-in. wide. 9 R 39401—Wt. 3 oz. . . \$3.49

**9** Long tape has double roller mouthpiece. Vinyl clad steel case. 3/8-in. wide. 9 R 39001—50-ft. Wt. 13 oz. \$17.99  
9 R 39002—100-ft. Wt. 1 lb. 2 oz. \$22.99

Replacement blade for (9). 9 R 39031—50-ft. Wt. 7 oz. \$8.99  
9 R 39032—100-ft. Wt. 14 oz. \$9.99

**10** 6-ft. folding rules have positive locking joints for rigidity. Brass extension for inside measurements.

Type	Catalog No.	Wt.	Price
Fiber glass	9 R 38752	6 oz.	\$11.99
Wood	9 R 3931	6 oz.	11.99

Tough-tip replacement blades for locking tapes fit Sears and most other brands. Order old size.

Width	Length	Catalog No.	Shpg. wt.	Price
1/2 in.	12 ft.	9 R 39176	2 oz.	\$2.29
3/4 in.	12 ft.	9 R 39177	3 oz.	2.79
3/4 in.	16 ft.	9 R 39178	4 oz.	3.29
3/4 in.	20 ft.	9 R 39179	5 oz.	3.79
3/4 in.	25 ft.	9 R 39173	6 oz.	4.29
1 in.	20 ft.	9 R 39172	6 oz.	4.49
1 in.	25 ft.	9 R 39171	7 oz.	5.49



## Special tools

**13** Revolving punch for leather and plastics makes much cleaner hole than awl. Punch wheel makes 5/64, 3/32, 7/64, 1/8, 5/32, 3/16-in. diam. holes. 9 R 4307—Shpg. wt. 8 oz. . . \$7.49

**14** Sewing airt kit easily penetrates heavy materials such as leather and canvas. Hardwood handles. Incl. 2 needles, 540-ft. nylon thread. 9 R 3380—Shpg. wt. 7 oz. . . \$8.49  
Extra nylon thread. 540-ft. roll. 9 R 36604—Shpg. wt. 3 oz. . . \$4.99

**15** 9-in. shop shears slice thru screening sheet metal, plastic. Forged steel blades have tapered cutting edges. Cushioned grips. Warranted by Sears, write for free copy, see p. 148.  
9 R 37091—Wt. 1 lb. . . \$14.99

**16** Contour gauge helps duplicate moldings and other irregular shapes. Forms a 6-in. wide contour. Stainless steel probes. 9 R 39561—Shpg. wt. 8 oz. . . \$9.49

**17 and 18** Protractors measure angles to ±1/2° accuracy. Magnetic base. Warranted by Sears, write for free copy, see p. 148.

Face diam.	Catalog No.	Wt.	Price
(17) 4-in.	9 R 3984	7 oz.	\$10.5
(18) 2-in.	9 R 3983	2 oz.	6.4

**19** Sliding T-bevel traces, transfers angles. Adjustable 8-in. steel blade with locknut. 9 R 39581—Shpg. wt. 4 oz. . . \$4.49

**20** Angle divider is graduated for 4, 5, 6, 8 and 10 segments of circle. Steel construction. 9 R 3868—Wt. 12 oz. . . \$24.99

**SHOP BY PHONE**  
To order, call your local Sears store

# levels, squares and accessories

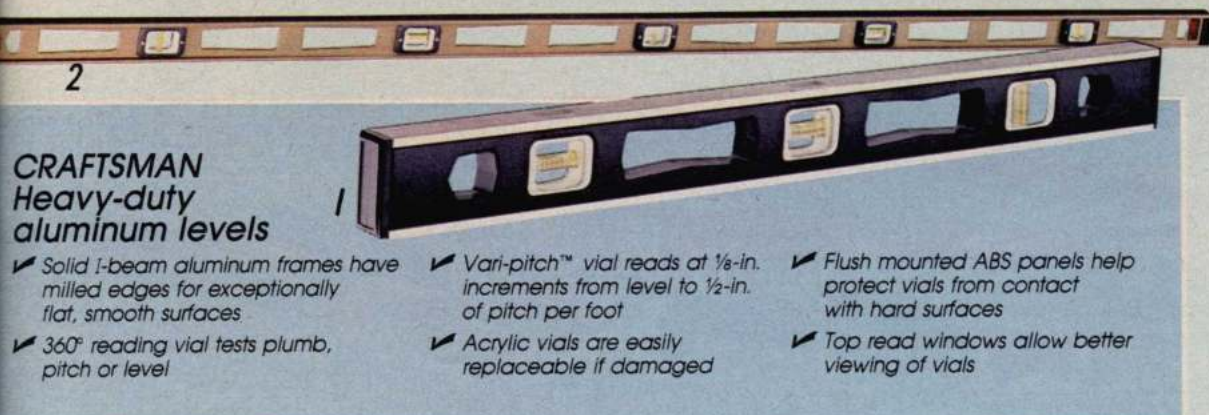

2

## CRAFTSMAN Heavy-duty aluminum levels

- ✓ Solid I-beam aluminum frames have milled edges for exceptionally flat, smooth surfaces
- ✓ 360° reading vial tests plumb, pitch or level

- ✓ Vari-pitch™ vial reads at 1/8-in. increments from level to 1/2-in. of pitch per foot
- ✓ Acrylic vials are easily replaceable if damaged

- ✓ Flush mounted ABS panels help protect vials from contact with hard surfaces
- ✓ Top read windows allow better viewing of vials



3

1 Heavy-duty levels have solid I-Beam aluminum frames for greater accuracy, less warpage. Variable pitch vial. Warranted\*.

Lgth. in.	Vials Plumb	Level	Catalog Number	Wt. lbs. oz.	Price
24...	1	1	9 R 39962	1 6	\$17.99
48...	2	1	9 R 39963	2 7	29.99

2 Heavy-duty construction like (1) above but with magnetic edge. Beveled endplates are shock, impact resistant. No variable-pitch vials. 48-in. level has ABS panels. Warranted\*.

Lgth. in.	Vials Plumb	Level	Catalog Number	Wt. lbs. oz.	Price
48...	2	2	9 R 39964	3 6	\$37.99
78...	3	2	9 R 39937C	5 12	59.99

3 CRAFTSMAN layout level is ideal for transferring plumb lines from floor to ceiling or installing drywall. Ext. from 78 to 120-in. Has 4 plumb, 1 level vials. Magnetic edge. Warranted\*.

4 CRAFTSMAN aluminum levels have solid I-Beam frame, 2 plumb, 1 top read vials. Top read window. Replaceable vials. Beveled end plates resist shock. Warranted\*.

9 R 39966—24-in. Wt. 1 lb. 3 oz. \$12.99  
9 R 39967—48-in. Wt. 2 lbs. 4 oz. \$21.99

5 CRAFTSMAN 9-in. torpedo level has aluminum I-Beam frame with 1 magnetic, 1 grooved edge. Warranted\*.

6 48-in. mahogany level has brass-bound edges that resist frame warpage. 6 glass vials read both level and plumb. Not Craftsman.

7 9-in. polystyrene torpedo level. Not Craftsman.

8 Lightweight durable polystyrene levels.

Lgth. in.	Vials			Catalog Number	Wt. lbs. oz.	Price
	Level	Plumb	45°			
24...	1	1	1	9 R 39823	1 10	\$6.99
48...	1	2	...	9 R 39824	1 10	12.99

9 CRAFTSMAN line and surface level. Hooks on line. Lays on flat or curved surfaces. Warranted\*.

10 CRAFTSMAN 5-in. pocket level has top read vial. Warranted\*.

11 CRAFTSMAN circular level reads in all horizontal directions at once. 1 1/4-in. diam. Warranted\*.



4 Aluminum level

Torpedo level

5

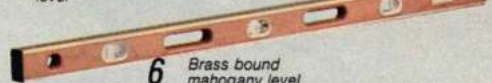

6 Brass bound mahogany level



Polystyrene torpedo level

Lightweight polystyrene level

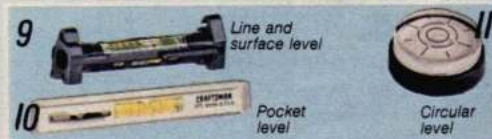

Line and surface level

Pocket level



Circular level



Rosewood clad woodworking tools

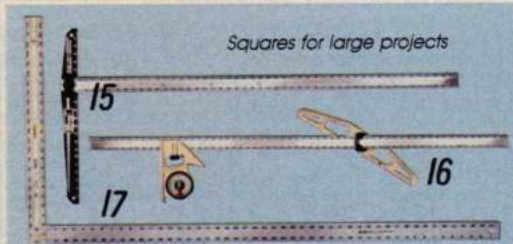

Squares for large projects

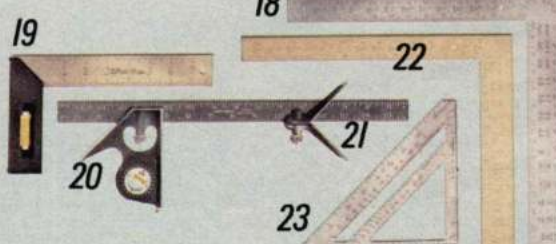

12 and 13 Carpenter's square with blued Sheffield steel blade has brass facing, strips and rivets. Attractive rosewood handle. 12 and 6-in. squares are imported.

Key	Blade length	Catalog Number	Wt. oz.	Price
(12)	12-in.	9 R 39603	13	\$12.99
(13)	9-in.	9 R 39602	11	10.99
...	6-in.	9 R 39601	8	8.99

14 Rosewood cutting gauge for scribing across the grain or slitting veneers. Imported.

Rosewood mortise and marking gauge has double pins (1 movable) on side of sliding piece and single pin on other for regular use. Imported.

15 CRAFTSMAN® drywall/paneling T-square has die-cast aluminum head with 4-ft. ground, beveled aluminum blade.

9 R 39572—Wt. 2 lbs. 8 oz. \$24.99

16 Combination T-square has adj. protractor and T-head of high impact polystyrene with built-in level and plumb vials, 5-ft. beveled edge aluminum blade.

17 24x48-in. square for large work converts from right to left hand square or use as 48-in. aluminum straight edge. Polystyrene blade.

18 CRAFTSMAN 16x24-in. framing square has a 24x2-in. body, 16x1 1/2-in. tongue. Permanently stamped graduations to 1/8-in. Satin aluminum finish.

19 CRAFTSMAN try square has 8-in. steel blade with 1/8-in. graduations. Hi-impact polystyrene handle with acrylic vial. Top reading. Warranted\*.

20 Our finest CRAFTSMAN combination square has 16x1-in. blade with 1/8, 1/16-in. graduations, machined head with built-in angle reference protractor. Incl. self-aligning draw bolt. Warranted\*.

21 CRAFTSMAN center head finds centers on bar stock, functions as marking gauge for following contour edges.

22 CRAFTSMAN solid-brass carpenter square features rafter table, brace table, octagon scale. Graduated in 8ths, 12ths, 16ths. 24x2-in. body, 16x1 1/2-in. tongue. Warp, corrosion resistant. Warranted\*.

23 CRAFTSMAN rafter square lays out common, jack, hip or valley rafters, 45° and 90° angles.

24 Brass angle or stair gauge fits on rafter or framing squares. Set of 2. Warranted\*.

25 4-pc. tool set incl. Polycast 24-in., 3-vial level, 9-in. 3 vial torpedo level, 12-in. Polysteel combination square and 8x12-in. carpenter square. Warranted\*.



Brass angle or stair gauge

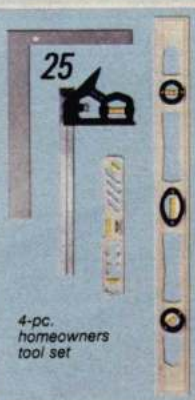

4-pc. homeowners tool set

# Our finest CRAFTSMAN® curved claw hammer

**\$13.99**

- ✓ Exclusive Third Claw™ feature pulls nails in tight places
- ✓ Forged ribs under claws add exceptional strength
- ✓ Machined face for uniform bevel and crown
- ✓ Headliner® steel shield provides extra strength to head
- ✓ Vinyl tip on handle can be used as mallet
- ✓ Chevron-patterned handle gives more control and better grip



**CRAFTSMAN Ball-peen hammer**

**CRAFTSMAN nail hammers**



**CRAFTSMAN rip-claw hammers**

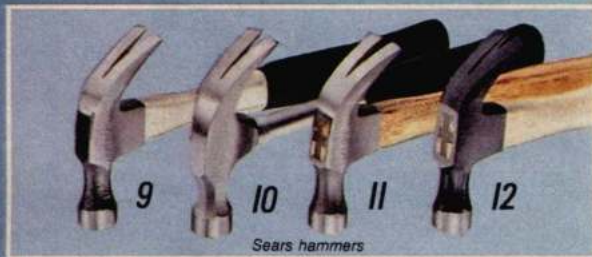

**Sears hammers**



**Specialty hammers**

**Shingling hatchet**

**Dry wall hammer**

**Half hatchet**

**Camp axe**



**Dead blow hammers**



**Cat's paw nail pullers**



**CRAFTSMAN pry bars and nail pullers**

**Nail set**

1 thru 8, 14 thru 23 CRAFTSMAN hammers are warranted by Sears, write for free copy, see p. 148.

1 Feel the difference quality makes when you use our finest nail hammer. 16-oz. head of heat-treated, drop-forged steel is crowned and beveled for positive striking power. Hickory handle.  
9 R 38045—Shpg. wt. 1 lb. 6 oz. . . . **\$13.99**

2 thru 4 16 oz. nail hammers similar to (1) except no headliner shield or vinyl tip on handle. Synthetic rubber grips.

2 Tubular steel handle has hickory wood plug for shock absorption. Perforated grip.  
9 R 38125—Shpg. wt. 1 lb. 9 oz. . . . **\$13.99**

3 Fiber glass handle has parallel fiber glass strands for strength, hollow core for balance. Chevron patterned grip.  
9 R 38126—Wt. 1 lb. 10 oz. . . . **\$13.99**

4 Solid steel handle has patented shock absorbing hickory wood plug, "air pocket" grip for comfort.  
9 R 38127—Wt. 1 lb. 10 oz. . . . **\$13.99**

5 thru 7 Rip-claw hammers of drop-forged steel are machine-faced for uniform bevel and crown. Fiber glass steel handles—synthetic rubber grips. All hammers 20 oz. and over except (7, 38097) have milled faces.

Key no.	Head wt.	Handle material	Catalog Number	Wt. lbs.	oz.	Price
5	16 oz.	Fiber glass	9 R 3821	1	9	<b>\$15.99</b>
6	20 oz.	Fiber glass	9 R 38094	1	14	<b>18.99</b>
6	20 oz.	Hickory	9 R 38096	1	11	<b>17.99</b>
6	20 oz.	Hickory	9 R 38097	1	2	<b>17.99</b>
6	24 oz.	Hickory	9 R 38098	1	15	<b>19.99</b>
6	28 oz.	Hickory	9 R 38161	2	9	<b>24.99</b>
6	16 oz.	Hickory	9 R 38092	1	9	<b>16.99</b>
6	16 oz.	Steel	9 R 38095	1	12	<b>16.99</b>
6	20 oz.	Steel	9 R 38273	2	...	<b>18.99</b>

8 Ball peen hammers have drop-forged, heat-treated steel heads with faces and peens machined for uniformity. Hickory handles.

Head wt.	Catalog Number	Wt.		Price
		lbs.	oz.	
4 oz.	9 R 38461	...	7 oz.	<b>\$8.99</b>
8 oz.	9 R 38463	...	12 oz.	<b>9.49</b>
12 oz.	9 R 38464	1 lb.	1 oz.	<b>9.99</b>
16 oz.	9 R 38465	1 lb.	4 oz.	<b>10.99</b>
24 oz.	9 R 38466	1 lb.	15 oz.	<b>11.99</b>
32 oz.	9 R 38467	2 lbs.	8 oz.	<b>13.99</b>

9 thru 11 Sears claw hammers have 16-oz. forged steel heads. Smooth face. Steel handles have synthetic rubber grip.

Key	Handle	Catalog Number	Shpg. wt. lb.	oz.	Price
9	Fiber glass	9 R 38124	1	10	<b>8.99</b>
10	Solid steel	9 R 38131	1	12	<b>8.99</b>
11	Wood	9 R 38312	1	5	<b>5.99</b>

12 Nail hammer has 16 oz. forged steel head and smooth wood handle.  
9 R 38143—Shpg. wt. 1 lb. 7 oz. . . . **\$3.49**

13 Heavy-duty hammer has 2½-lb. steel head and 15-in. hickory handle.  
9 R 38262—Wt. 2 lbs. 15 oz. . . . **\$13.99**

14 Hand-drilling hammer has 3-lb. steel head and 9¾-inch hickory handle.  
9 R 38311—Shpg. wt. 3 lbs. 7 oz. . . . **\$13.99**

15 Rubber mallet has 16-ounce, 2-inch diameter head and a lacquered handle. 13 inches long. Not Craftsman. Imported.  
9 R 4579—Shpg. wt. 1 lb. 3 oz. . . . **\$3.49**

16 Bricklayer's hammer has 16-ounce forged steel head; 11-inch hickory handle.  
9 R 6546—Shpg. wt. 1 lb. 5 oz. . . . **\$18.99**

17 Plastic-tip hammer has 1 hard, 1 soft tip. 12-ounce steel core head, 12½-inch hickory handle.  
9 R 38292—Shpg. wt. 1 lb. 2 oz. . . . **\$10.99**  
9 R 38296—Hard repl. tip. Wt. 2 oz. . . . **\$1.49**  
9 R 38297—Soft repl. tip. Wt. 2 oz. . . . **\$1.49**

18 Shingling hatchet has 14-oz. steel head; 12¾-in. hickory handle. U.S., metric gauges.  
9 R 4828—Shpg. wt. 1 lb. 7 oz. . . . **\$22.99**

19 Dry wall hammer has patented, flat 12-oz. head design. 15¼-inch hickory handle.  
9 R 3808—Shpg. wt. 1 lb. 3 oz. . . . **\$19.99**

20 Half hatchet gives 3¼-in. cut. 13-in. wood handle has wood plug for shock-absorption.  
9 R 48285—Shpg. wt. 1 lb. 10 oz. . . . **\$13.99**

21 All-steel camp axe has 1¼-lb. head, 2¼-in. cutting edge and a 13-inch steel handle. Includes protective sheath.  
9 R 4810—Shpg. wt. 1 lb. 11 oz. . . . **\$22.99**

22 and 23 Hundreds of metal shot in core of head maximize striking force, minimize rebound. Urethane UNICAST handle retains shape and is non-sparking. (23) has urethane face; (22) steel.

Item	Head wt.	Catalog Number	Shpg. wt. lbs.	oz.	Price
(22) Soft face	2 lbs.	9 R 38111	2	...	<b>24.99</b>
Soft face	3 lbs.	9 R 38112	3	4	<b>36.49</b>
(23) Ball-peen	8 oz.	9 R 38113	...	14	<b>\$25.99</b>

24 Cat's paw nail pullers are designed to withdraw small finishing brads. Claws have rounded base to minimize marring. Includes 6¼, 10½, 13-in. size.  
9 R 46992—Shpg. wt. 1 lb. 13 oz. . . . **\$9.99**

25 Steel wrecking bar. ¾x30-in.  
9 R 65981C—Wt. 4 lbs. 8 oz. . . . **\$10.99**

26 12-inch steel nail puller.  
9 R 6595—Wt. 1 lb. 3 oz. . . . **\$7.49**

27 ¾x17¼ inch rip bar.  
9 R 6578—Wt. 2 lbs. 3 oz. . . . **\$8.99**

28 Steel Pull-n-Pry bars. 2x15-in.  
9 R 6591—Wt. 1 lb. 8 oz. . . . **\$8.99**  
9 R 65941—¾x5¼-in. Wt. 2 oz. . . . **\$2.29**

29 4-piece nail setting tool set includes ½, ⅜, ¼, ⅜ and ⅝-inch sizes.  
9 R 37547—Shpg. wt. 6 oz. . . . **\$6.99**



Critt™ vise holds irregularly shaped objects

1 Clamp-on vise has cast iron body and jaws. Permanent pipe jaws are 3½-in. wide, 2½-in. cap. Not Craftsman.  
9 R 5247—Wt. 3 lbs. 13 oz. **\$10.99**

2 Available in Catalog only! Swivel hobbyist vise locks at nearly any angle to position items for easier handling. 2½-in. cap. V-groove jaws with removable soft jaw protector.  
9 R 25146—Wt. 5 lbs. ... **\$29.99**

3 Available in Catalog only! The Critt™ vise clamping system is made up of specially shaped pieces of rigid PVC plastic which fit into a series of holes in pre-drilled base to hold irregularly shaped objects. Incl. pre-drilled add-on shelf, instructions.  
9 R 65522—Wt. 10 lbs. ... **\$29.99**

### Woodworking vises

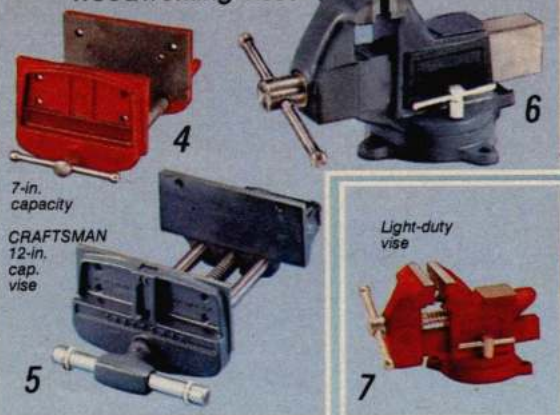

7-in. capacity

CRAFTSMAN 12-in. cap. vise

Light-duty vise

4 Critt™ vise similar to one at left but without pre-drilled add-on shelf. Templates for drilling holes incl.  
9 R 65521—Shpg. wt. 12 oz. **\$12.99**

4 Woodworker's vise has cast-iron body, jaws. Steel guide bar. Steel drag bar. 4¼x7-in. jaw face is predrilled for wood face (not incl.). 180° continuous threaded steel screw. Not Craftsman.  
9 R 51915—Wt. 11 lbs. **\$37.99**

5 CRAFTSMAN woodworker's vise has smooth cast-iron 4x10-in. jaws, predrilled for wood face (not incl.). Rapid action slides vise closed. Retractable "dog" acts as bench stop. Steel guide bars keep jaws aligned.  
9 R 51781C—Wt. 34 lbs. ... **\$79.99**

6 CRAFTSMAN industrial machinists' vises have ductile iron bodies, jaws. Replaceable jaw faces. Covered cold-rolled steel screw. Base swivels 360°, locks. See note below.

Opens to	Jaw size	Catalog Number	Wt. lbs.	Price
4 in. ...	3 in.	F 9 R 51961C	25	<b>\$139.99</b>
6 in. ...	4 in.	F 9 R 51963C	43	<b>169.99</b>
8 in. ...	5 in.	F 9 R 51965C	70	<b>249.99</b>

Stationary base vise like above.

Opens to	Jaw size	Catalog Number	Wt. lbs.	Price
4 in. ...	3 in.	F 9 R 51962C	21	<b>\$124.99</b>
6 in. ...	4 in.	F 9 R 51964C	38	<b>149.99</b>
8 in. ...	5 in.	F 9 R 51966C	60	<b>219.99</b>

NOTE: Unavailable. Allow extra time for delivery. Contact Sears unit for shipping and handling charges. No C.O.D. orders.

### CRAFTSMAN® heavy-duty bench vises

- ✓ V-grooves provide extra gripping strength
- ✓ Instant action vise screw for immediate opening and closing
- ✓ Polished rear channel top provides light duty work surface

New at Sears!

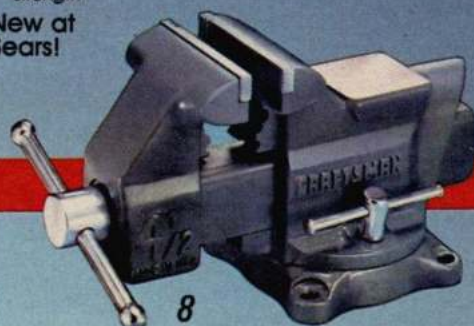

7 Reinforced cast-iron bodies, jaws. Base swivels 165°, locks. Tempered jaw faces. Imported. Not Craftsman.

Opens to	Jaws size	Catalog Number	Wt. lbs. oz.	Price
3 in. ...	3½ in.	9 R 5178	10 2	<b>\$12.99</b>
4 in. ...	4½ in.	9 R 5163C	18 ...	<b>27.99</b>

8 Vises have 4 mounting lugs; angular lock nuts for easy operation. Extra channel support on back jaw. Reversible jaw inserts are smooth on one side, serrated on other. Chrome-plated steel screw. Long lock nut handle.

Opens to	Jaw size	Catalog Number	Wt. lbs.	Price
4 in. ...	3½ in.	9 R 51861C	16	<b>\$27.99</b>
5 in. ...	4½ in.	9 R 51865C	26	<b>44.99</b>
6 in. ...	5½ in.	9 R 51871C	37	<b>64.99</b>



### CRAFTSMAN bench planes

- ✓ Cast-iron base
- ✓ Double plane cutter

CRAFTSMAN primus jack plane has rugged beechwood body, extra-tough lignum vitae sole

**\$99.99**

Items (11, 14 thru 18) and (24 thru 27) are available in Catalog

9 Sears smooth No. 4 bench plane for all-purpose planing is 9¾ inches long. 2-inch wide steel blade. Imported.  
9 R 37168—Wt. 3 lbs. 12 oz. **\$29.99**

10 Our finest CRAFTSMAN® bench planes have milled and ground bottom and sides. Double plane cutter, snug-fit frog. 9¾-in. long, 2-in. wide blade. Imported. Warranted\*.  
Smooth No. 4.  
9 R 37164—Wt. 3 lbs. 13 oz. **\$41.88**

Jack No. 5.  
9 R 37165—Wt. 4 lbs. 11 oz. **\$52.49**  
2-inch wide replacement blade for (9) and (10).  
9 R 37066—Wt. 4 oz. ... **\$8.99**

11 Primus jack plane has beech body, lignum vitae sole. Cutter set at 50° angle. 15½ inches long. Imported.  
9 R 37154—Wt. 4 lbs. 10 oz. **\$99.99**

12 Sears block plane is 6½ in. long with 1½ in. blade. Imported.  
9 R 37167—Wt. 1 lb. 5 oz. ... **\$9.49**

13 CRAFTSMAN lock plane lets you chamfer with one hand. Steel blade cutter sets at 21° angle for planing small surfaces. 7 inches long. 1½ inch steel blade. Imported. Warranted\*.  
9 R 37151—Wt. 1 lb. 15 oz. **\$17.99**

14 Block plane is conveniently sized to fit in one hand. Use for general trimming or end grain work. Unique blade adjustment system. White beechwood with lignum vitae sole. 5½ inches long; 1½-inch wide steel blade. Imported.  
9 R 37028—Wt. 1 lb. 3 oz. ... **\$29.99**

15 Expert jack plane for quickly planing wood to dimensions and general planing. 1½-inch adjustable cutter. 9¾-inch varnished beech body with hornbeam wood sole. Imported.  
9 R 37029—Wt. 2 lbs. 8 oz. **\$49.99**

16 Primus jack plane has hornbeam wood body, lignum vitae sole. Blade set at 45° angle for general work. 9½ inches long. Blade width measures 1½ inches. Imported.  
9 R 37030—Wt. 3 lbs. ... **\$69.99**



Expert jack plane

Primus jack plane

15

16

17

18

19

20

21

22

23

24

25

26

27

17 Our finest Primus reform smooth plane has adjustable blade and throat. Pearwood body, lignum vitae sole. 8½ inches long; 1½ inch wide blade, bedded at 52½°. Imported.  
9 R 37022—Wt. 3 lbs. ... **\$79.99**

18 Primus trying plane has blade adjustment system. Hornbeam wood body, lignum vitae sole. 2-ft. long. Blade width 2½ in. Imported.  
9 R 37021—Wt. 6 lbs. 10 oz. **\$99.99**

19 Compact bullnose plane of machined steel. 3¾-in. long; 1½-in. wide blade. Imported.  
9 R 37013—Wt. 1 lb. ... **\$24.99**

20 Folding drawknife adjusts to 3 working angles. Handles fold over blade for protection. Chamfered blade slots for comfortable grip. 10-inch steel blade. Imported.  
9 R 37059—Wt. 1 lb. 12 oz. **\$19.99**

21 Chamfering and board plane provides 30° or 60° angles on any edge. 8¼ inches long. Replaceable blades. Imported.  
9 R 37155—Wt. 1 lb. 2 oz. ... **\$9.99**

\*Warranted by Sears, write for free copy, see page 148.



22 Small router plane is 3 inches long. ¼-inch wide cutter. Imported.  
9 R 37011—Wt. 4 oz. ... **\$12.99**

23 Handy pocket plane for chamfering and fine trimming. Low pitch is suitable for end grain work. 3½ in. long with 1-in. blade. Imported.  
9 R 37053—Shpg. wt. 5 oz. ... **\$5.99**

24 thru 27 CRAFTSMAN shaping tools have chisel-like teeth; die-cast zinc alloy bodies. Cut and form materials up to the hardness of mild steel. Imported. Warranted\*.

24 9-inch round file type with hardwood handle. ⅝-inch diameter blade.  
9 R 67743—Shpg. wt. 5 oz. ... **\$6.99**

25 1½x5½-inch pocket plane type.  
9 R 67745—Wt. 7 oz. ... **\$4.99**  
9 R 67746—Extra blade.  
Shpg. wt. 2 oz. ... **\$2.29**

26 1½x5½-inch plane type.  
9 R 67742—Wt. 15 oz. **\$8.99**  
9 R 67747—Extra blade.  
Shpg. wt. 2 oz. ... **\$2.69**

27 7½-inch hand shaping tool.  
9 R 67744—Wt. 3 oz. ... **\$4.49**



1 26-in. heavy gauge taper-ground blade. Hardwood handle. Includes blade guard. 10 pts. per in. Warranted.\*  
9 R 36236C—Shpg. wt. 1 lb. 12 oz. . . \$15.99  
Saw like above with 12-pts. per in.  
9 R 36235C—Shpg. wt. 1 lb. 12 oz. . . \$15.99

2 Master combination rough-cut saw has precision bevel ground teeth flame-hardened for durability, fast cutting. 26-in. blade has 10 teeth per in. Hardwood handle. Blade guard. Imported. Warranted.\*  
9 R 36228C—Shpg. wt. 1 lb. 13 oz. . . \$15.99

3 Flat-ground saws have tempered steel blades. 26-in. blade has bevel-filed teeth attached to hardwood handle. Blade guard. Warranted.\*  
9 R 36233C—8 pts. Wt. 1 lb. 12 oz. . . \$11.99  
9 R 36234C—10 pts. Wt. 1 lb. 12 oz. . . \$11.99

4 Combination saw has flat-ground high-carbon steel 26-in. blade with 8 pts. per in. Hardwood handle. Blade guard.  
9 R 36232C—Shpg. wt. 1 lb. 12 oz. . . \$8.99

5 Hand saw has 26-in. carbon steel blade with 8-pts. per in. Plastic handle.  
9 R 36231C—Shpg. wt. 1 lb. 4 oz. . . \$4.49

6 Reversible dovetail saw has offset blade for flush cuts without damaging adjacent surfaces. 1 7/8x10-in. steel blade has 14 teeth per in. Brass back; wood handle. Imported.  
9 R 36201—Shpg. wt. 6 oz. . . \$11.99

7 Small dovetail saw for fine work. 2 1/2x10-in. steel blade with 14 teeth per in. has brass back. Beechwood handle.  
9 R 36202—Imported. Wt. 6 oz. . . \$9.99

8 CRAFTSMAN dovetail saw has a 10-in. precision-ground high-carbon tempered steel blade with 11 pts. per in. Walnut stained handle. Blade guard. Warranted.\*  
9 R 35194—Shpg. wt. 9 oz. . . \$7.99

9 Dovetail saw. 9 3/4-in. steel blade has 20 teeth per in. Steel reinforced back. Wood handle.  
9 R 36198—Imported. Wt. 8 oz. . . \$19.99

10 Sears back saw. Steel blade with 11 pts. per in. Braced back; 14x 3/4-in. blade.  
9 R 36182—Shpg. wt. 13 oz. . . \$6.99

11 Straight edge saw has 2 sets of teeth; 10 teeth per inch for crosscut work and 5 teeth per inch for ripping. 10 3/8-inch blade of hard steel. Wood handle. Imported.  
9 R 36197C—Shpg. wt. 12 oz. . . \$19.99

12 thru 14 CRAFTSMAN hack saws incl. steel blade. Warranted.\*

12 Flush-cutting saw features a quick-release blade with self-adjusting tension. Cuts in 4 positions. Front-end grip. Can be used as jab saw. Aluminum, steel frame; encl. handle.  
9 R 3554—Shpg. wt. 1 lb. 9 oz. . . \$16.99

13 Premium-quality flush-cut saw. Front end grip, tension wheel. Cuts in 4 positions. Chrome-plated tubular steel frame.  
9 R 3559—Shpg. wt. 1 lb. 2 oz. . . \$11.49

14 Adjustable saw. Nickel-plated steel frame, high-impact (ABS) plastic encl. handle. Cuts in 4 positions. Holds 10 or 12-in. blade.  
9 R 3557—Shpg. wt. 1 lb. . . \$7.49

15 Standard cutting saw has nickel-plated steel frame and plastic handle.  
9 R 3563—Shpg. wt. 14 oz. . . \$4.29

16 Jab saw gives flush, close quarter cut. Plastic handle with steel blade holder, clamp holds hack saw or reciprocal saw blade.  
9 R 3556—Shpg. wt. 5 oz. . . \$4.29

17 Jewelers' saw is ideal for fine, intricate cuts and veneer work. Adjustable frame fits blades 2 1/2 to 6 1/2 in. long. Incl. 12 blades.  
9 R 52704—Shpg. wt. 7 oz. . . \$9.99

86 Extra blades for (17). Package of 24.  
9 R 52705—Wt. pkg. 1 oz. . . Pkg. \$4.49

New at Sears! Our finest CRAFTSMAN® taper-ground hand saw  
Chrome nickel steel blade has bevel-filed teeth for easier cutting

YOUR CHOICE \$15.99 Available in 12 or 10 pts. per in.

18 CRAFTSMAN coping saw cuts wood, light metal. 6 1/2-in. pin end blade adjusts for angle cuts. 6 3/4-in. throat. Hardwood handle. Warranted.\*  
9 R 3541—Shpg. wt. 2 lbs. 1 oz. . . \$5.39

CRAFTSMAN coping saw blades. Warranted.\*

Type Blade	Catalog No.	Wt.	Pkg. of 3
Lock-loop-end	9 R 3542	1 oz.	Ea. pkg. \$1.49
Pin-end (med.)	9 R 3544	1 oz.	Ea. pkg. 1.49
Asstd. pin-end (1 coarse, med., fine)	9 R 3543	1 oz.	Ea. pkg. 1.49

19 Keyhole saw cuts on pull stroke. 8-in. taper-ground blade. Wood handle. Imported.  
9 R 36196—Wt. 4 oz. . . \$4.99

20 CRAFTSMAN compass saw cuts irreg. shapes. High-carbon tempered steel 10-in. blade. 10 teeth per in. Locating screw secures blade to plastic handle. Warranted.\*  
9 R 35192—Wt. 4 oz. . . \$3.79

21 CRAFTSMAN "Toolbox Trio" incl. 3 interchangeable high-carbon tempered steel blades; one 6-in. dry wall blade . . . 10 teeth per in.; one 8 1/2-in. metal-cutting . . . 24 teeth per in.; one 12-in. wood-cutting . . . 8 teeth per in. Patented adjustable chuck locks blades in any position.  
9 R 35193—Warranted.\* Wt. 8 oz. . . \$8.99

CRAFTSMAN replacement blades for item (21).  
9 R 35131—6-in. dry wall. Wt. 1 oz. . . \$1.19  
9 R 35132—8 1/2-in. metal cutting. Wt. 2 oz. . . \$1.49  
9 R 35133—12-in. wood cutting. Wt. 3 oz. . . \$2.19

CRAFTSMAN miter or back saw has high carbon steel blade with beveled, hollow ground teeth, 11 points per in. Braced back. Hardwood handle. Warranted.\*

Blade size	Catalog Number	Shipping wt.	Price
16x3 1/2-in.	9 R 36183	1 lb. 10 oz.	\$11.99
18x3 1/2-in.	9 R 36189	2 lbs. 5 oz.	17.99
22x4-in.	9 R 36188C	3 lbs. 12 oz.	19.99
26x4-in.	9 R 36184C	4 lbs. 5 oz.	24.99

Remington™ "Grit Edge" steel and tungsten carbide cutting edges (not shown). Fit regular hack saws.  
9 R 65861—10-in. rod saw. Wt. 1 oz. . . \$3.29  
9 R 65862—12-in. blade. Wt. 1 oz. . . \$3.79

Hack saw blades (not shown). 24-tooth blades cut iron, pipe, med. tubing to 1/4-in. 18-tooth blades cut steel bars, brass, copper to 1/4-in.

Semi-flexible blades. Package of 5.  
9 R 65853—10-in., 24 teeth per in. Wt. 3 oz. . . \$1.99  
9 R 65854—12-in., 24 teeth per in. Wt. 4 oz. . . \$2.19  
9 R 65851—10-in., 18 teeth per in. Wt. 3 oz. . . \$1.99  
9 R 65852—12-in., 18 teeth per in. Wt. 4 oz. . . \$2.19

High-speed blades (last longer than semi-flexible). Package of 2. Shpg. wt. 2 oz.  
9 R 65856—12-in., 24 teeth per in. . . Pkg. \$2.79  
9 R 65855—12-in., 18 teeth per in. . . Pkg. \$2.79

22 Saw set grips saw and accurately sets tip of tooth to proper angle for clean cuts while maintaining saw strength. For hand saws with 4 to 12 points per in. and up to 1.6 mm. thick.  
9 R 37034—Shpg. wt. 12 oz. . . \$6.99

23 Saw sharpener has precise feather edge file that works with blades with up to 22 teeth per in. Incl. adapters for circular saw blades.  
9 R 37035—Imported. Wt. 12 oz. . . \$24.99

24 CRAFTSMAN medium-duty sawhorse brackets are hinged steel; epoxy finish. Includes flanged nail holes. Set of 2.  
9 R 28872—Wt. set 1 lb. 10 oz. . . Set \$4.49

25 Sears sawhorse brackets are galvanized steel. Incl. nail or screw holes. Set of 2.  
9 R 30073—Wt. set 1 lb. . . Set \$2.49

26 CRAFTSMAN heavy duty sawhorse brackets of foam molded high-impact styrene fasten with a steel nut and bolt on each end to secure legs, bracket and beam together. Set of 2.  
9 R 28878—Wt. set 1 lb. 10 oz. . . Set \$8.99  
\*Warranted by Sears. Write for free copy, see p. 148.

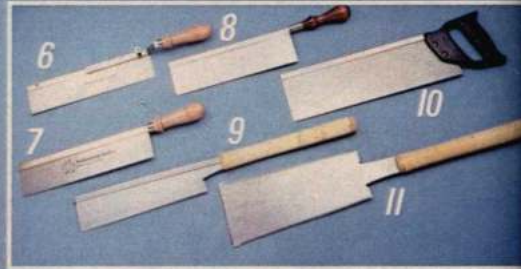

ONE QUALITY NAME

**CRAFTSMAN**

OFFERS MORE GOOD CHOICES



3 CRAFTSMAN® premium quality Miter Box with free-floating saw . . . includes work-clamp

\$89<sup>99</sup>



Our exclusive Compound-cutting Miter Box lets you cut a 45° angle and bevel at the same time! Work-clamp included

\$149<sup>99</sup>

\*10 MONTHLY, see page 148



CRAFTSMAN Miter Box has free-floating saw

\$54<sup>99</sup>



CRAFTSMAN Miter Box gives quality cuts in small capacities

\$54<sup>99</sup>



CRAFTSMAN Miter Box has full-range indexing system

\$27<sup>99</sup>



Versatile Miter Box has screw-holes for permanent mounting to work bench

\$11<sup>99</sup>

1 Our exclusive CRAFTSMAN® compound-cutting Miter Box features a large die-cast base and greater distance between guide posts to let you cut larger capacities of wood . . . up to 10-in. pieces. Accurate to within .005-in. thru 4-in. cut. Independent front/rear saw guide system has free-floating twin tubular guides, 12-in. apart. Saw stops allow depth control for dado work and duplicating cuts. Saw hangers allow for 2-hand positioning of workpiece. Comes with work clamp to hold piece firmly. (See item (2) below for description of clamp.) Positive stops at major horizontal and vertical angles. 26x5-in. saw with hard lacquer finish. This box has all the features of (3 and 4) and more. Warranted.\*  
9 R 36309C—Shpg. wt. 28 lbs. . . Set \$149.99

2 Available in Catalog only. Miter Box Clamp (shown with item 1) mounts on almost any size miter box. Does not fit (6) above, right. Not Craftsman.  
9 R 66662—Shpg. wt. 1 lb. 6 oz. . . \$7.99

3 and 4 CRAFTSMAN professional-quality Miter Boxes have angle index 5 in. from pivot point for extended accuracy. Cam-lock quick-angle setting is accuracy tested to ± ½°. Takes pieces up to 5¾ in. wide at 90°, up to 3½ in. wide at 45°. Base, back are 1-piece die-cast metal alloy and machined flat. Polyurethane work support helps protect saw teeth. Wide stance offset steel legs have mounting holes. Warranted.\*

3 CRAFTSMAN Premium quality Miter Box has free-floating saw guides 8 inches apart which control the saw completely through the workpiece. Independent front-rear system. Tension-controlled jumbo nylon rollers adjust to any saw thickness. Saw stops for 2-hand control. Includes work clamp. 22x4-inch high carbon steel miter saw cuts to 4 inches deep. Warranted.\*  
9 R 36308C—Shpg. wt. 18 lbs. . . \$89.99

4 CRAFTSMAN Miter Box has free-floating saw guides 8 inches apart, which control saw completely through the workpiece. Four nylon rollers adjust to any saw thickness. Max. depth of cut 3½ inches. 18x3½-in. high carbon steel blade has wood handle. Warranted.\*  
9 R 36304—Shpg. wt. 14 lbs. 3 oz. . . \$54.99

5 This CRAFTSMAN Miter Box gives you quality cuts in smaller capacities. Free-floating, twin tubular guides are 8 inches apart. Takes pieces up to 6 in. wide at 90° and 3¾ in. wide at 45°. Maximum cutting depth is 4 in. This box includes 2 high-carbon steel blades; one for wood and a hack saw for cutting metal. Warranted.\*  
9 R 36307—Shpg. wt. 8 lbs. . . \$54.99

6 This CRAFTSMAN Miter Box has a full-range indexing system and full-size back. Cuts any angle from 45° left to 45° right, to a maximum of 3¼ inches deep. It cuts maximum 5½ inches at 90° and 4½ inches at 45°. Free-floating saw guides guide saw completely through the workpiece and adjust to any saw thickness. Full size aluminum back. Fiberboard base has raised rubber bumpers for stability. Includes 3¼x14-inch saw. Warranted.\*  
9 R 36332—Shpg. wt. 6 lbs. . . \$27.99

7 ABS plastic Miter Box lets you bevel cut at 45° up to 3¾ in. high with its 45° diagonal slot. Also cuts conventional 45°, 90° angles. Screw holes allow permanent mounting to workbench. Includes carbon steel saw. Not Craftsman.  
9 R 36312—Shpg. wt. 2 lbs. 4 oz. . . \$11.99  
\*Warranted by Sears, write for free copy, see page 148

**Specialty Brushes**

Catalog No.	Wt. ea. (oz.)	Each	2 or more (each)
(8) 9 R 3664	1	\$1.99	\$1.69
(9) 9 R 3647	10	\$3.99	\$3.39
(10) 9 R 3669	7	\$2.49	\$2.11
(11) 9 R 3668	6	\$1.99	\$1.69
(12) 9 R 3666	1	\$1.59	\$1.35
(13) 9 R 3665	1	\$1.59	\$1.35
(14) 9 R 3667	10	\$8.99	\$7.64
(15) 9 R 3651	2	\$1.49	\$1.26



**Save 15%**  
when you buy any 2 or more  
Specialty Brushes

## 12-inch, 3-HP max. industrial-rated table saw

- ✓ Has our most accurate fence-alignment feature
- ✓ Extra-wide, 48x30-inch work surface
- ✓ 9-pc. accessory kit with metal case



**\$1999<sup>99</sup>**  
Only \$67 MONTHLY†

Solid cast-iron table has two parallel miter gauge "T" slots for use with the pair of "T" blocks (incl.). Together, they provide the most accurate rip fence to blade alignment feature on any table saw we sell! 39 $\frac{3}{4}$ -in. rip fence (on nylon rollers) is supported by 66 $\frac{3}{4}$ -in. front, rear guide rails... permits a 38-in. cut to the right of blade (with rip fence). Rip fence works on both sides of the blade. "Quick release" automatic front, rear tension grip locks fence into position. Front guide rail scale calibrated in inches and millimeters, may be read thru magnified window for close tolerances. 4-in. depth of cut at 90°, 2 $\frac{3}{4}$  in. at 45°. 1-inch arbor is changeable to  $\frac{1}{2}$ -in. (short or long extension to accommodate blade) for dadoing; blade (not incl.) tilts to a 45° maximum cut. Accessory kit incl.: 2 "T" blocks with screws; 3, 5, 8mm hex wrenches; 3 double-ended spanner wrenches (sizes 11-13mm, 12-14mm, 17-19mm) and spanner wrench with 2 pins for easy arbor installation. Also incl. rip fence; dado plate; 1 and  $\frac{1}{2}$ -in. arbors; die-cast miter gauge with "T" slot roller guide, motor, pulley, belts. Rear mounted magnetic contactor box for easy wiring. 220-volt, single-phase 3450 rpm motor. Steel cabinet with 4-in. sawdust exhaust port. 34 $\frac{1}{4}$ Hx31Wx23 $\frac{1}{2}$ -in. deep. Imported. Warranted.\* See note below right.

F 9 R 22652N—Shipping weight 628 pounds... \$1999.99



**\$1499<sup>99</sup>**  
Only \$50 MONTHLY†

1 $\frac{1}{2}$ -HP industrial-rated jointer planer can work boards up to 8 $\frac{1}{8}$ -in. wide... provides our largest work table capacity at a full 90 in. long with table extensions

Balanced all steel, 3-knife cutter head (ball bearings) provides 13,500 cuts per min.; cartridge can be removed, replaced in minutes. Cuts 8 $\frac{1}{8}$ Wx $\frac{1}{2}$ -in. D. max., positive stop at  $\frac{1}{8}$ -in. D. with override. Allows rabbeting. Dovetail table ways allow easy height adjustment to in-feed, out-feed tables; simplifies alignment of out-feed table to cutter head (position locks on both tables). 9Wx66-in. L table surface; 24-in. extensions incl. 4Hx36-in. L tilt fence adjusts L45°, 90°, R45° at positive stops with level control. 3450-rpm induction/capacitor start motor. Overall 35 $\frac{1}{2}$ Hx25Wx66-in. L. Steel cabinet has chip chute, 5-in. hose adapter; houses 240-v., 60-Hz. motor. Incl.: knife setting gauge, push blocks, pulleys, belt, switch, magnetic contactor box, 6-ft., 3-wire cord. Imported. Warranted.\* See note at right.

F 9 R 20651N—Shipping weight 476 lbs. . . \$1499.99

- ✓ Safety cutter guard covers cutter knives before, during, and after use
- ✓ Knife setting gauge rests on outside diameter of cutter head... the blades will stay at the proper height when locked

## Industrial-rated band saw

- ✓ Cuts wood and metal up to 29 inches wide
- ✓ One-piece unitized steel body really stands up to heavy use
- ✓ 1-HP motor develops maximum of 2 $\frac{1}{2}$ -HP

**\$999<sup>99</sup>**  
Only \$34 MONTHLY†



Choose from 4 speeds (195, 500, 1270 or 3000 feet per min.) for the speed best-suited to the material being cut. 8 $\frac{3}{4}$ -in. max. resawing capacity. Accepts blades from  $\frac{3}{16}$  to 1-in. wide. Rugged cast iron table has 15x15-in. work surface and tilts up to 45°. Includes miter gauge, rip fence and 2 blades. Built-in 3-in. diam. sawdust port. Unit operates smoothly on two 15-inch cast aluminum wheels. Measures 30x24x76 in. high overall. Wired for 120 volts. Order extra blades below. Imported. Warranted\*.

9 R 24392N—Shipping weight 369 lbs. . . \$999.99

For	LxW (in.)	Teeth per in.	Catalog Number	Wt. oz.	Price
Wood	104x $\frac{1}{4}$	6	9 R 26554	4	\$5.99
Wood	104x $\frac{1}{2}$	4	9 R 26555	6	6.99
Wood	104x $\frac{3}{4}$	4	9 R 26556	8	8.99
Metal	104x $\frac{1}{4}$	14	9 R 26557	4	9.99
Metal	104x $\frac{1}{2}$	24	9 R 26558	6	10.99
Metal	104x $\frac{1}{2}$	14	9 R 26559	8	10.99

2 and 3 For quiet operation and low maintenance, these saws have direct-drive, induction-run motors. Automatic blade brake and thermal overload protection. Rip scales on left and right sides for in or out ripping. Fixed miter stops at center, 45° left or right; fixed bevel stops at vertical, 45° and horizontal. Anti-kickback pawls and spreader. Includes Kromedge steel blade. Warranted.\*

2 Max. depth-of-cut is 4 in. at 90°, 2 $\frac{1}{16}$  in. at 45°. Offers 27 $\frac{1}{2}$ x44x1 inch work surface. 240-v. only. Shipping weight 171 lbs. 9 R 1989N... \$649.99

3 Max. depth-of-cut is 4 in. at 90°, 2 $\frac{3}{4}$  in. at 45°. Has 27-in. rip capacity, 16-in. crosscut capacity in 1-in. stock. Depth-of-cut, miter controls. Extra-durable cast-iron arm, column support. 29 $\frac{1}{2}$ x28 $\frac{1}{2}$ x $\frac{3}{4}$  in. thick Masonite® hardboard worktable.  $\frac{1}{2}$ -in. arbor. Key lock. Wired for 120/208/240-v. See tool guard sold below. Shipping weight 235 lbs. T 9 R 2318N... \$949.99

Saw (3) as 3-phase, 2 HP that develops 5 HP. Shipping weight 242 lbs. T 9 R 2319N... \$1199.99

Tool guard for molding, dadoing. Shipping weight 2 lbs. 7 oz. T 9 R 23189... \$44.99

\*Warranted by Sears. Write for free copy, see page 148.

Items with a "T" prefix (such as T 9 R 2318N) could take extra time for delivery

†See page 168

NOTE: Unavailable. Allow 10 days for delivery. Contact Sears selling unit for shipping and handling charges. No C.O.D. orders.



12-inch heavy-duty radial saw with maximum developed 3 $\frac{1}{2}$ -HP motor for your biggest projects

**\$649<sup>99</sup>**  
Only \$22 MONTHLY†



12-inch heavy-duty cast iron radial saw has maximum 3 $\frac{1}{2}$ -HP motor and steel stand

**\$949<sup>99</sup>**  
Only \$32 MONTHLY†



**CRAFTSMAN**  
7-inch Disc Sander/grinder  
develops up-to 4-HP  
\$139.99

Available in Catalog only!



**CRAFTSMAN**  
1/4-HP  
Heavy-duty  
Belt Sander  
\$149.99



**CRAFTSMAN**  
This 4 1/2-inch. Right-angle  
Grinder is our most popular model  
\$57.99



**CRAFTSMAN**  
Industrial-rated Electronic  
Router has no-load speeds  
of 11,000 to 25,000 rpm  
\$119.99



Industrial-rated  
Electric  
Heat Gun  
\$49.99



Move heavy  
tools and  
furniture  
with convenient  
Dolly Wheels  
and Casters

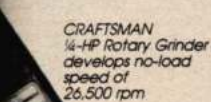

**CRAFTSMAN**  
1/4-HP Rotary Grinder  
develops no-load  
speed of  
26,500 rpm  
\$59.99

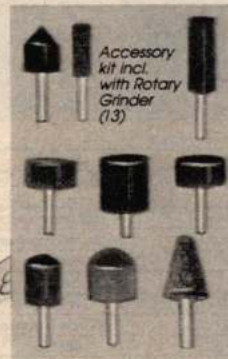

Accessory  
kit incl.  
with Rotary  
Grinder  
(7.3)



Vitrified  
aluminum  
oxide  
grinding  
points



Grinder  
Stand

Rotary cutter and  
carbide burs

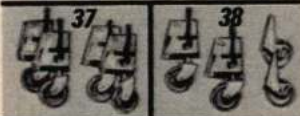

**Save 15%**  
when you buy  
any 2 or more  
Dolly Wheels or Casters

No-load speed of 6000 rpm. Die-cast aluminum motor and gear housing, polycarbonate body. 15 amps. C/DC. 8 ft., 3 wire cord. Warranted.\*  
R 27742—Wt. 14 lbs. 8 oz. . . \$139.99

Sander/grinder (not shown) same as (1), but accepts either 7 or 9-inch grinding or sanding accessories. 3-HP. No-load speed of 5000 rpm. 13 amps. 4-ft., 3 wire cord. Warranted.\*  
R 27741—Wt. 14 lbs. 8 oz. . . \$129.99

Dust pick-up and Auto-Trak® belt alignment system. No-load speed of 1400 feet per minute. 4x5 1/4-inch sanding surface uses 4x2 1/4-inch belts. 1.2 wire cord. Warranted.\*  
Shpg. wt. 11 lbs. 12 oz.  
R 27705 . . . \$149.99

1-HP motor develops no-load speed of up to 12,000 rpm. Bevel gears in die-cast aluminum housing. Polycarbonate housing and handles. 15 amps. Warranted.\*  
R 27702—Wt. 6 lbs. . . \$57.99

Grinder Kit (not shown) incl. case; grinder (3); sanding kit (6) and sanding disc.  
R 27710—Wt. 9 lbs. . . \$69.99

3-in. wire cup for (3) fits 10x1.5 metric arbor.  
R 64131—Wt. 11 oz. . . \$10.99

Metric thread twist brush fits (3). 10x1.5 M. arbor.  
R 64126—Wt. 12 oz. . . \$10.99

4 1/2-inch sanding kit converts (3) into sander.  
R 11149—Wt. 10 oz. . . Kit \$9.49

4 1/2-inch grinding wheels for (3). Aluminum oxide, 30 grit. Pkg. of 1.  
R 64104—Wt. 5 oz. . . Ea. \$4.99

Silicon Carbide, 24 grit. Package of 2.  
R 64105—Wt. 9 oz. . . Pkg. \$8.79

Grinding wheel made of fine aluminum oxide. 5/8-in. arbor.  
7-inch wheel. Wt. 1 lb. 6 oz.  
R 64101 . . . \$7.49  
9-inch wheel. Wt. 2 lbs.  
R 64102 . . . \$8.79

9 7-inch sanding kit converts (1) into sander.  
9 R 11157—Wt. 13 oz. . . \$9.99

10 Grinding guard for (1) when using wheel.  
7-inch guard. Wt. 1 lb. 7 oz.  
9 R 27745 . . . \$17.99

9-inch guard. Wt. 2 lbs. 8 oz.  
9 R 27747 . . . \$19.99

5-in. fine grinding wheels (not shown). Aluminum oxide and fiberglass. 30 grit. 5/8-in. arbors. Pkg. of 2.  
9 R 64103—Wt. 6 oz. . . pkg. \$10.49

11 Overload protector and slow starting feature. Depth gauge has 1/4-in. increments and zero reset. Collet grips 1/4-in. diam. bits; wrench incl. Chip deflector, shaft lock. Ball bearings. Warranted.\*  
9 R 27501—Wt. 8 lbs. 15 oz. . . \$119.99

12 Electric heat gun is ideal for applications where open flames might be hazardous. 2 speed settings, 2100 and 3000 fpm at 700° or 1000° F. Gun can be held or stands on side, top or back. Incl. slip-on deflector for uniform heat distribution. 750-w. 6-ft. 3-wire cord. Shpg. wt. 3 lbs. 2 oz.  
9 R 27112 . . . \$49.99

13 Collet-type chuck grips 5/8, 1/4-in. diam. shanks. Includes 9 grinding points, wrench, hanging bail, collet adapter, Permanex® plastic case. Warranted.\*  
9 R 27445—Wt. 5 lbs. 9 oz. . . \$59.99

Grinder alone.  
9 R 2744—Wt. 3 lbs. 12 oz. . . \$49.99

Permanex® plastic case; 16x6 1/2x3 1/2 in.  
9 R 1463—Wt. 1 lb. 3 oz. . . \$7.99

14 thru 22 Grinding points have 1/4-inch steel shanks.

Item	Diam.	Length	Catalog No.	Wt.	Each
(14)	1 1/2 in.	3/4 in.	9 R 64711	1 oz.	99¢
(15)	1 in.	1/2 in.	9 R 64712	1 oz.	99¢
(16)	3/4 in.	1 in.	9 R 64715	1 oz.	99¢
(17)	1 in.	1 in.	9 R 64718	1 oz.	99¢
(18)	1/2 in.	1 1/2 in.	9 R 64714	1 oz.	99¢
(19)	1 in.	1 in.	9 R 64719	1 oz.	99¢
(20)	1 in.	1/2 in.	9 R 64717	1 oz.	99¢
(21)	3/4 in.	1 1/2 in.	9 R 64716	1 oz.	99¢
(22)	3/4 in.	1 in.	9 R 64713	1 oz.	99¢

All 9 grinding points (14-22) above. Separate prices total \$8.91.  
9 R 6471—Wt. 8 oz. . . Set \$7.99

23 Cast-iron stand for grinder (13). Shpg. wt. 4 lbs. 3 oz.  
9 R 25846 . . . \$34.99

24 thru 29 CRAFTSMAN high-speed steel rotary cutters. Type M-2. 1/4-in. steel shanks.

Item	Diam.	Shape	Catalog No.	Wt.	Each
(24)	1/4 in.	Cylindrical	9 R 2966	1 oz.	\$4.49
(25)	1/4 in.	Spherical	9 R 2967	1 oz.	4.49
(26)	3/8 in.	Tree pointed	9 R 2970	1 oz.	5.79
(27)	3/8 in.	Elliptical	9 R 2968	1 oz.	5.79
(28)	1/4 in.	Conical	9 R 2971	1 oz.	4.49
(29)	1/4 in.	Tree radius	9 R 2969	1 oz.	4.49

6-pc. Cutter set for (13) includes (24 thru 29). Set prices total \$29.54.  
9 R 2965—Wt. 3 oz. . . Set \$26.99

30 thru 35 Solid-carbide Burs: 1/8 in. shanks.

Item	Shape	Catalog No.	Wt.	Each
(30)	Tree shape	9 R 25642	1 oz.	\$5.49
(31)	Cylindrical	9 R 25641	1 oz.	5.49
(32)	Tree radius	9 R 25646	1 oz.	5.49
(33)	Ball shape	9 R 25645	1 oz.	5.49
(34)	Conical	9 R 25643	1 oz.	5.49
(35)	Cylindrical radius	9 R 25644	1 oz.	5.49

6-pc. burr set for (13) includes (30 thru 35). Separate prices total \$32.94.  
9 R 2561—Wt. 1 oz. . . \$29.99

36 6-inch super dolly has 200-lb. load rating. Three 1 1/4-inch polyolefin wheels swivel on self-lubricating bearings. Neoprene foam corner pads, recessed center hole holds objects firmly. Steel triangular dolly.  
9 R 74138—Wt. ea. 1 lb.  
Each \$5.99 . . . 2 or more, ea. \$5.09

37 and 38 Heavy-duty caster sets support up to 400 lbs. Fit Craftsman tool stands, leg sets and cabinets, except models 9-19821-31-41-61-51.

37 Four swivel casters all with foot operated lever for raising or lowering.  
9 R 22222—Wt. ea. set 10 lbs.  
Set \$54.99 . . . 2 or more, ea. set \$46.74

38 Two front-swivel casters with foot operated lever for raising or lowering and two non-swivel rear casters.  
9 R 22221—Wt. ea. set 6 lbs.  
Set \$44.99 . . . 2 or more, ea. set \$38.24

39 thru 41 Semi-steel and powdered iron casters, all have flat top-plate and zinc-plated finish. Self-lubricating ball bearing; semisteel and iron have plain ball bearings. Load capacities are maximum stated per caster when in motion, double when motionless.

39 3-inch diameter wheel, 3 1/8-inch caster height; 2 1/2-inch swivel caster radius. 1-inch wide tread. 210-lb. load capacity.

Rigid caster.  
9 R 74471—Wt. ea. 1 lb. 8 oz.  
Each \$5.99 . . . 2 or more, ea. \$5.09

Swivel caster.  
9 R 74474—Wt. ea. 1 lb. 13 oz.  
Each \$6.49 . . . 2 or more, ea. \$5.51

4-inch diameter wheel, 5-in. caster height, 3 1/2-in. swivel caster radius. 1 1/2-inch wide tread. 300-lb. load capacity.

Rigid caster.  
9 R 74477—Wt. ea. 2 lbs. 12 oz.  
Each \$9.99 . . . 2 or more, ea. \$8.49

Swivel caster.  
9 R 74481—Wt. ea. 3 lbs. 8 oz.  
Each \$10.99 . . . 2 or more, ea. \$9.34

40 Semi-steel 4-in. diam. wheel, 5-in. caster height; 3 1/2-inch swivel caster radius 1 1/2-in. wide tread. 350-lb. load capacity.

Rigid caster.  
9 R 74478—Wt. ea. 3 lbs. 10 oz.  
Each \$9.99 . . . 2 or more, ea. \$8.49

Swivel caster.  
9 R 74482—Wt. ea. 4 lbs. 7 oz.  
Each \$10.99 . . . 2 or more, ea. \$9.34

41 3-in. diam. wheel, 3 1/8 in. caster height; 2 1/2-in. swivel radius. 1-in. wide tread. 250-lb. load capacity.

Rigid caster.  
9 R 74472—Wt. ea. 2 lbs. 1 oz.  
Each \$5.99 . . . 2 or more, ea. \$5.09

Swivel caster.  
9 R 74475—Wt. ea. 2 lbs. 5 oz.  
Each \$6.49 . . . 2 or more, ea. \$5.51

\*Warranted by Sears. Write for free copy, see page 148.

**SEARS CREDIT**  
To apply, call this TOLL-FREE number  
1-800-323-3274  
In Illinois, Call 1-800-942-7446 89

When you need a tool as serious as the work you do . . .



1  
1/2-inch Drills

3/8-HP single-speed reversible Drill  
**\$139<sup>99</sup>**



2  
1/2-HP variable-speed reversible Drill

**\$99<sup>99</sup>**

(3 thru 5) 3/8-inch Variable-speed Reversible Drills



3  
1/3-HP Drill with 0 to 2000 rpm variable no-load speed  
**\$69<sup>99</sup>**



4  
1/2-HP Drill with 0 to 1200 rpm variable no-load speed  
**\$89<sup>99</sup>**



5  
1/2-HP Drill with dual range variable no-load speeds for precision drilling in metal or softer materials  
**\$109<sup>99</sup>**

Drill (Warranted*)	(1) 3/8-HP	(2) 1/2-HP	(3) 1/2-HP	(4) 1/2-HP	(5) 1/2-HP
Speed	450 rpm	0-550 rpm	0-2000 rpm	0-1200 rpm	0-1200 rpm for metal 0-2500 for softer materials
Bearings	Ball and roller	Ball and roller	Ball and roller	Ball and roller	Ball and roller
Gearing	Triple reduction spur	Triple reduction spur	Double reduction spur	Double reduction spur	Double reduction spur
Chuck size	1/2-inch	1/2-inch	3/8-inch	3/8-inch	1/2-inch
Amps	6	4.5	3.5	4.5	4.5
Catalog Number	9 R 2711	9 R 27121	9 R 27100	9 R 27101	9 R 27102
Shipping weight	9 pounds 12 ounces	5 pounds 2 ounces	4 pounds 8 ounces	4 pounds 9 ounces	4 pounds 5 ounces
Price now	\$139.99	\$99.99	\$69.99	\$89.99	\$109.99

Tools on this page are UL listed. (1) is 110-120-v., 60-Hz AC/DC. All others are 120-v., 60-Hz AC.



6  
1/2-HP variable-speed Drywall Screwdriver

**\$79<sup>99</sup>**



8  
Available in Catalog only!  
1/2-HP, adjustable torque, reversible Screwdriver

**\$129<sup>99</sup>**

Power Screwdrivers



7  
1/2-HP, 3/8-inch variable-speed Screwdriver/drill  
**\$109<sup>99</sup>**

6 1/2-HP drywall screwdriver. Variable speeds 0 to 4000 rpm. Ball, roller, sleeve bearing. Spur gearing. 4.5 amps. Reversible. Warranted. 9 R 27110—Shpg. wt. 3 lbs. 8 oz. . . \$79.99

7 This screwdriver/drill has variable no-load speeds of 0 to 1200 rpm. Ball, roller, sleeve bearings. Double-reduction spur gearing. 4.5 amps AC. 8 ft., 2-wire cord. Warranted. 9 R 27103—Shpg. wt. 4 lbs. . . \$109.99

8 1/2-HP adjustable torque, reversible electric screwdriver. Variable no-load speeds from 0 to 2500 rpm. Permanently lubricated ball and roller bearings. Double-reduction spur gearing. 4.5 amps. Warranted. 9 R 27108—Wt. 3 lbs. 15 oz. . . \$129.99

9 and 10 These cordless tools have a single no-load speed of 800 rpm. 8 cell energy pack. Ball and oil impregnated bearing spur gearing. One hour recharge (charger not included extra below. 100-watt DC. Warranted. 9 R 27131—Wt. 9 lbs. 4 oz. . . \$109.99

10 Screwdriver/drill. 9 R 27133—Wt. 9 lbs. 12 oz. . . \$119.99

A spare energy pack can help you work without stopping . . . pop it in while the other is being replenished (not shown). Use in (9 or 10). Can be charged from 120-v. AC or 12-v. DC source. 9 R 27906—Shpg. wt. 1 lb. 8 oz. . . \$39.99

11 No-load speed of 2100 rpm, 2700 impacts per minute. 7.5-amp motor provides 240-lbs. of torque. Reversible. Warranted. 9 R 27512—Shpg. wt. 7 lbs. 12 oz. . . \$119.99

Handy polyethylene carrying case (not shown) lets you store impact wrench and accessories. Closed, 15 1/2 x 11 x 4 1/2 inches high. 9 R 14771—Wt. 2 lbs. 1 oz. . . \$9.99

\*FULL 1-YEAR WARRANTY ON CRAFTSMAN INDUSTRIAL PORTABLE ELECTRIC TOOLS. If this Craftsman Tool fails due to a defect in material or workmanship within one year from date of purchase, Sears will repair it, free of charge. Warranty service is available by simply returning the tool to the nearest Sears store or Service Center in the United States. This warranty gives you specific legal rights, and you may have other rights which vary from state to state. Industrial tools comply with applicable O.S.H.A. standards.



9  
3/8-inch cordless Drill with removable energy pack and case  
**\$109<sup>99</sup>**



10  
3/8-inch cordless Screwdriver/Drill with adjustable clutch has removable energy pack and case  
**\$119<sup>99</sup>**



11  
1/2-inch square-drive impact Wrench powers thru the rough jobs  
**\$119<sup>99</sup>**

# Choose CRAFTSMAN® Industrial-rated Portable Electric Tools

Forged of impact-resistant materials and heavier internal components, they're designed to handle the demands of construction and industry professionals for years to come!

Worm-drive gearing provides unsurpassed torque... easily handles severe shock loads in this 2½-HP, 7¼-inch Circular Saw



**\$89<sup>99</sup>**

3 Our industrial-rated circular saws have smooth running helical gears, depth, bevel control and soft. 3-wire rubber insulated cord; ¾-in. arbor. Incl. 1 blade. Warranted.\*

4000 rpm no-load speed. Cutting depth: 1¾-in. at 90°, 1½-in. at 45°. Die-cast aluminum blade guards permit use of cut-off wheels. Conventional pivoting foot. 6.5 amps AC. \$89.99

9 R 2754—Wt. 8 lbs. 5 oz. . . \$89.99



**\$119<sup>99</sup>**

2 5200 rpm no-load speed. Cutting depth: 2¾-in. at 90°, 1¾-in. at 45°. Pivoting foot. 12 amps AC/DC. 10-ft., 2-wire cord. \$119.99

9 R 27541C—Wt. 16 lbs. . . \$119.99

Replacement diamond arbor blades.

Size in.	Cat. No.	Shpg. wt.	Price
Kromedged steel blades			
6½	9 R 32306	8 oz.	\$4.49
7¼	9 R 32307	12 oz.	4.69
8¼	9 R 32308	1 lb.	5.29
Carbide blades			
6½	9 R 32453	11 oz.	\$14.49
7¼	9 R 32455	15 oz.	17.49
8¼	9 R 32456	1 lb. 4 oz.	20.99



**\$129<sup>99</sup>**

3 These saws provide the deepest cuts of any circular saw we sell! Drop foot design maintains the most efficient hand angle to work surface.

RPM	Cutting depth		Amps Current
	at 90°	at 45°	
7¼-inch, 2¼-HP saw.			
5800	2½-in.	1¾-in.	13 AC/DC
9 R 2751C—Wt. 17 lbs. . . . . \$129.99			
10¼-inch, 2¾-HP saw.			
5200	3½-in.	2¼-in.	15 AC/DC
9 R 2753C—Wt. 22 lbs. . . . . \$239.99			

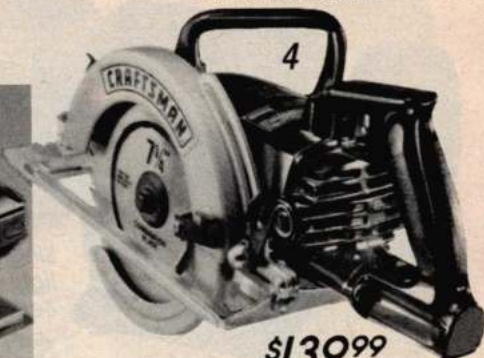

**\$139<sup>99</sup>**

4 No-load speed of 4400 rpm. Cuts wood to 2¾-in. at 90°, 1½-in. at 45°. Die-cast aluminum base with depth, bevel controls. Incl. 1 diamond arbor blade, order extras at left. 8-ft., 16-ga., 3-wire cord. 13 amps AC/DC. Warranted.\* 9 R 2761C—Wt. 19 lbs. . . \$139.99

Edge-guide for worm-drive saws. 9 R 27761—Wt. 10 oz. . . \$6.49

Lubricant for worm-drive saws. 5½-oz. can. 9 R 27762—Wt. 8 oz. . . Can \$2.49



Heavy-duty ¾-HP Reciprocating Saw Kit cuts wood, aluminum, steel, even pipe! \$119<sup>99</sup>



14 Variable-speed Sabre Saw \$109<sup>99</sup>



15 Two-speed Sabre Saw \$99<sup>99</sup>



16 Electronic variable-speed Sabre Saw \$79<sup>99</sup>



17 ½-HP Metal-cutting Shears \$89<sup>99</sup>

Compact, yet powerful... Portable Band Saw

**\$399<sup>99</sup>**



Save 25% on this worm-drive Saw Case when you also buy a worm-drive saw!

Save 25% on this Multi-tool Case when you also buy any tool on these two pages!

5 thru 12 Blades for reciprocating saws.

Lgth. in.	Teeth per inch	Uses†	Catalog Number	Wt. oz.	Price
9-metal blades have high-speed steel teeth and high carbon steel back for flexibility and durability.					
5)	6	24	(F)	9 R 28692	1 2.99
	4	24	(F)	9 R 28693	1 2.99
	6	14	(C)	9 R 28694	1 2.99
6)	6	7	(A)	9 R 28691	1 2.99

CRAFTSMAN blades ½-inch steel shanks.

7)	12	7	(A)	9 R 28685	2 \$2.79
8)	9	3	(B)	9 R 28682	2 2.19
9)	6	14	(C)	9 R 28686	1 2.19
10)	6	7	(D)	9 R 28684	1 2.09
11)	6	7	(E)	9 R 28681	1 1.79
12)	6	24	(F)	9 R 28683	1 2.19

†(A) Smooth cuts up to 10-in. thick in wood, plastic, composition board, hardboard; scroll cuts; (B) Fast, rough cuts in wood over 1 in. thick; (C) Rough cuts in wood, cuts nails; (D) Flush cuts in wood and plastic; (E) Smooth cuts in wood, plastic, comp. board, plunger, scroll cuts; (F) Steel, other metals up to ½ in. thick

6-pc. blade pack incl. all 6 CRAFTSMAN blades sold above. Sep. prices total \$13.24.

9 R 28687—Shpg. wt. 7 oz. . . Set \$12.49

13 Select no-load speeds of 1800 (for metal) or 2400 (for wood) strokes per min. with 1½-in. blade stroke. Spiral bevel gearing. Uses ½-in. shank blades. Incl. 7 blades, wrench, polyethylene case. 8-ft. cord. 6 amps. Warranted.\* 9 R 27122—Wt. 10 lbs. 12 oz. . . Kit \$119.99

14 Runs at 0 to 3100 spm. Uses ¼-inch shank blades. Die-cast motor housing. 8-ft. cord. 4.5 amps. Warranted.\* 9 R 27251—Shpg. wt. 6 lbs. 12 oz. . . \$109.99

15 Uses ¼-inch shank blades. Die-cast motor housing. 4.5 amps, 8-ft. cord. Runs 2100 to 3100 spm. Warranted.\* 9 R 27241—Shpg. wt. 6 lbs. 12 oz. . . \$99.99

16 Electronic feedback controlled speed maintains smooth cutting under load. 0 to 3000 spm at 20° increments. Blade pivots 360°. One inch blade stroke. Base tilts 45° L or R, bevel scale. 2 blade openings (blade not incl.). Dust blower. Chip shield and edge guide with trammel point. 8-ft. cord. Warranted.\* 9 R 27240—Shpg. wt. 7 lbs. 11 oz. . . \$79.99

17 Cut up to 19 ga. (.042 in.). No-load speed of 2700 spm. Steel cutting head. Die-cast aluminum gear case, thermoplastic body. 8-ft., 2 wire cord. Warranted.\* 9 R 2738—Shpg. wt. 5 lbs. 6 oz. . . \$89.99

Nibbler head accessory (not shown) for (17). 9 R 2739—Shpg. wt. 12 oz. . . \$24.99

18 Cuts circular stock up to 3½ inches in diameter, rectangular stock up to 3½x4½ in. Two no-load speeds of 200, 250 fpm. Double-planetary gear drive with ball bearings. Incl. 44½-in. blade. 8-ft., 3 wire cord. 4-7.5 amps, AC/DC. Die-cast motor, housing. Warranted.\* 9 R 2720C—Shpg. wt. 22 lbs. . . \$399.99

19 Polyethylene tool case, 13Lx26½Wx8½D inches. 9 R 14709—Wt. 5 lbs. 4 oz. . . alone \$21.99

When you buy worm-drive saw (4) . . . \$16.49

20 Polyethylene tool case, 13Lx26½Wx8½D in. 9 R 1472C—Wt. 7 lbs. 12 oz. . . alone \$21.99

When you buy any tool on these 2 pages . . . \$16.49

\*Warranted by Sears. See page 148.

**CRAFTSMAN Bench Grinders are more versatile than you might imagine. These tools buff, polish, grind, sharpen, hone, even sand when equipped with the proper accessories!**



1  
Single-speed,  
light-duty  
Bench Grinder  
**\$26<sup>99</sup>**  
and up



2  
Variable-speed  
Homeowner  
Bench Grinder  
**\$56<sup>99</sup>**  
and up



3  
Available in  
Catalog only†  
Industrial-rated  
Bench Grinder  
**\$199<sup>99</sup>**  
I-HP

- ✓ Direct-drive, induction motor develops more torque than our homeowner grinders
- ✓ Durable die-cast aluminum construction

- ✓ Extra-wide spaced wheels for larger workpieces
- ✓ Runs cooler to last longer
- ✓ I-HP model includes lamp

- ✓ Our exclusive sliding switch lets you choose speeds from 1000 to 3800 rpm
- ✓ Built for wide range of uses with powerful permanent magnet motor



Wet Sharpening and Honing Attachment

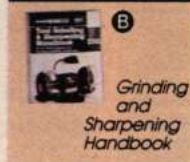

Grinding and Sharpening Handbook

1 Light-duty single-speed Grinder features permanent magnet motor. See notes below, right. Not rated in HP. Warranted.\*

Threaded shaft	RPM max.	Wheels (in.) diam. clearance	LxWxH inches	Catalog Number	Wt.	Price
½-12 in...	3800	5 10	12x7x8	9 R 19043	9 lbs. 8 oz.	\$26.99
½-12 in...	3800	6 10.2	13x8x9	9 R 19044	10 lbs.	46.99

2 Variable-speed grinder. Removable covers on 6-in. grinding wheels with 13-inch wheel clearance... extra-wide spacing gives you maximum maneuverability. 2 aluminum oxide wheels: medium fine and medium coarse. Incl. Lexan® plastic eye shield and an adjustable tool rest. Spark arrestor. High-quality ABS thermoplastic housing; rubber mounts reduce vibration. Approximately 16½Lx9Wx10H inches. ½-15-in. threaded shaft. Warranted.\* See Notes at right.

HP	Catalog Number	Shipping weight	Price
¼	9 R 19046C	16 pounds	\$56.99
½	9 R 19047C	18 pounds	66.99
¾	9 R 19048C	18 pounds	76.99

A 32½-in. high Grinding Stand with cooling pot. Heavy-duty cast iron stand bolts to floor, bolts not included. Unassembled. 9 R 19210C—Shipping weight 55 pounds... \$69.99

Grinder stand (not shown) 32Hx10¼x8½-in. sq. table. 9 R 2963C—Shpg. wt. 22 lbs. . . \$39.99

3 Runs cooler to last longer, even under rugged garage or school shop conditions. Rubber mounts reduce vibration for greater control. UL listed. Die-cast aluminum housing and wheel covers, dust chutes. Adjustable tool rest and Lexan® plastic eyeshield. Spark arrestor. Aluminum oxide grinding wheels, medium fine and medium coarse. Extra-capacity quench tray. Warranted.\* See Safety Note below.

HP	Dev. HP	Threaded shaft	Wheels-in. Diam.	Clear.	LxWxH in.	Catalog Number	Wt. lbs.	Price
115/230-v.	60-Hz. AC	Features gooseneck lamp. Bulb not incl., order on p. 93	1	1.5	¼-18-in.	8 16	20¼x10½x12	9 R 19219C   45   \$199.99
3-phase motor.	208-v. AC. 60-Hz.	No cord. Lamp not incl., order on p. 93.	¾	1.1	¼-18-in.	8 16	21x11x12	9 R 19218C   45   \$299.99
115-v., 60-Hz. AC	3-wire cord. Lamp not incl., order on p. 93		¾	1.1	½-20-in.	7 15	19x10x11	9 R 19217C   35   \$159.99
115-v., 60-Hz. AC	3-wire cord. Lamp not incl., order on p. 93		½	¾	½-20-in.	6 14	18x9x11	9 R 19216C   27   \$129.99

GRINDING SAFETY NOTE: Do not grind on side of wheels, except with (5) sold on p. 93. Use only with straight relieved flanges as large as, or larger than, diameter shown in table below. Use guard and shatterproof glass shield covering ¾ of wheel. Never exceed rpm shown. Wear safety goggles sold on p. 59. Stand aside for 1 minute after starting wheel. Follow instructions on wheels. Not for use on wood, except when using (3) sold on p. 93.

Wheel diameter (inches)	5	6	7	8
Flange diameter (inches)	2	2	2½	2½
Maximum RPM	3800	3800	3600	3600

B 128 information-packed pages with over 100 illustrations and pictures. Shpg. wt. 10 oz. 9 R 21645... \$9.99

C Turning at only 100 rpm (approx.), the 8½-in. aluminum oxide wheel will not overheat tools so you can sharpen knives, scissors, axes and other blades. Fits all Craftsman grinders except 9-19211. Shpg. wt. 6 lbs. 9 R 6610... \$49.99

NOTE: UL listed. 110-115 volts. 60-Hz. AC. Incl. 6-ft. 3-wire cord.

\*Warranted by Sears. Write for free copy, see p. 148. †All units except 9-19217C

You don't have to look any farther to find the accessories that make your grinder a multi-dimensional addition to your workshop!



Flexible Gooseneck Lamp



Silicon-carbide Dressing Stone

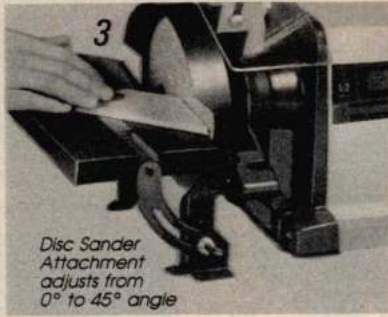

Disc Sander Attachment adjusts from 0° to 45° angle



Grinding Wheel Dresser



Bit Grinder Attachment



Router Bit Attachment for sharpening high-speed router bits



Drill bit Sharpening Attachment for 1/8 to 1-inch masonry and woodboring bits



Use drill bit Sharpener with pedestal-mount of bench grinder (not incl.)

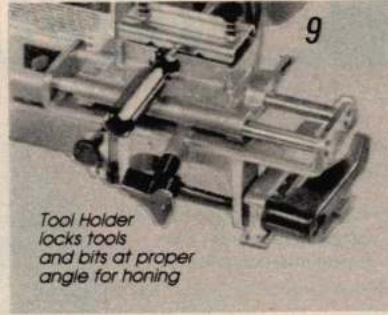

Tool Holder locks tools and bits at proper angle for honing

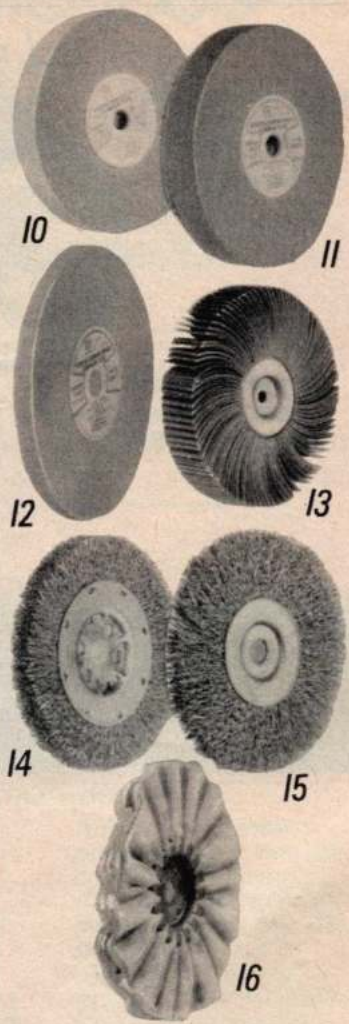

1 Gooseneck Lamp attaches to any Craftsman grinder. Bulb not incl., see (98120) below. 9 R 19244—Shpg. wt. 2 lbs. . . \$19.99

50-watt Rough-service Bulb for (1) 9 R 98120—Shpg. wt. 3 oz. ea. . . Ea. \$2.99

6-watt heavy-duty Vibration Bulb. 9 R 3803—Shpg. wt. 1 oz. ea. . . Ea. \$2.79

Accessories (2 thru 16) Available in Catalog only!

2 For aluminum oxide, carbide grinding wheels. 9 R 6491—Shpg. wt. 9 oz. . . \$9.99

3 Disc Sander Attachment with 5 1/2 x 10-in. wide table. Protractor adjusts 0° to 60°. 9 R 64856—Shpg. wt. 3 lbs. 8 oz. . . \$19.99

4 Carbon steel cutter wheels to dress irregular or glazed grinding wheels. 9 R 25282—Shpg. wt. 1 lb. 6 oz. . . \$6.99

5 Locks drill bits at proper angle for sharpening. For twist drill bit sizes 1/8 to 3/4 in., Nos. 1 to 30, A to Z, 3 to 19 mm. Adjustable for all popular drill point angles. Use with grinding wheel (11). 9 R 6677—Shpg. wt. 2 lbs. 4 oz. . . \$14.99

6 Sharpens all bits, except carbide-tipped. Use with wheel (12). 9 R 6660—Shpg. wt. 2 lbs. 2 oz. . . \$19.99

7 Bit Sharpening Attachment. Fine-feed adj. screw. Use with wheels 9-64258, 9-64259, 9-64261 at right. Fits all Craftsman grinders except 9-19211. 9 R 6665—Shpg. wt. 2 lbs. 4 oz. . . \$24.99

White Rouge Buffing Compound for (16). Use on stainless steel, chrome, aluminum and brass. 9 R 2860—4-oz. bar. Shpg. wt. 5 oz. . . 99¢

Buffing Compound for (16). Use on metal, plastic. 9 R 2865—4-oz. bar. Shpg. wt. 4 oz. . . 99¢

8 Drill Bit Sharpener for any length, letter, number, fraction or metric size (1/8 to 1/2-in. diam.). Grinding done in front of wheel; use medium-coarse grit. 9 R 6672—Shpg. wt. 3 lbs. 3 oz. . . \$26.99

9 For sharpening chisels, screwdrivers. Blade guide locks bladed tools at proper angle for sharpening and honing. Great for garden tools and long blades. 9 R 19596—Shpg. wt. 4 lbs. 2 oz. . . \$27.99

10 thru 15 Grinding Wheels make your bench grinder even more versatile.

(10) Fine grit. For knives, keen-edge tools, finishing, polishing. Aluminum oxide.

Size (inches)	Grit	Arbor Hole (inches)	Catalog Number	Wt. (lbs. oz.)	Price
5x1/2	100	1/2	9 R 64243	13	\$4.79
5x3/4	100	1/2	9 R 64317	1 2	5.29
5x3/4	100	1/2	9 R 64319	1 3	7.19
6x1/2	100	1/2	9 R 64321	1 8	7.39
6x3/4	100	1/2	9 R 64353	3 1	8.99
7x1	100	1/2-5/8	9 R 64354	4 1	9.99

Medium. For axes, wood-cutting tools, preparation for finishing. Aluminum oxide.

Size (inches)	Grit	Arbor Hole (inches)	Catalog Number	Wt. (lbs. oz.)	Price
5x1/2	60	1/2	9 R 64244	13	\$4.79
5x3/4	60	1/2	9 R 64207	1 1	5.29
5x3/4	60	1/2	9 R 64209	1 4	7.19
6x1/2	60	1/2	9 R 64211	1 12	7.39
6x3/4	60	1/2	9 R 64221	2 9	8.49
7x1	60	1/2-5/8	9 R 64214	3 1	8.99
8x1	60	5/8	9 R 64355	4	9.99

Coarse. For machine shop. Aluminum oxide.

Size (inches)	Grit	Arbor Hole (inches)	Catalog Number	Wt. (lbs. oz.)	Price
5x1/2	36	1/2	9 R 64245	13	\$4.79
5x3/4	36	1/2	9 R 64356	1 4	5.29
5x3/4	36	1/2	9 R 64352	1 5	7.19
6x1/2	36	1/2	9 R 64232	1 7	7.39
6x3/4	36	1/2	9 R 64233	2 9	8.49
7x1	36	1/2-5/8	9 R 64235	3 8	8.99
8x1	36	5/8	9 R 64236	4 10	9.99

Size (inches)	Grit	Arbor Hole (inches)	Catalog Number	Wt. (lbs. oz.)	Price
---------------	------	---------------------	----------------	----------------	-------

(11) For sharpening twist drill bits. Use with (5) for side grinding. Aluminum oxide.

Size (inches)	Grit	Arbor Hole (inches)	Catalog Number	Wt. (lbs. oz.)	Price
6x1	60	1/2-5/8	9 R 64222	2 2	\$8.39

Fine grit. For sharpening carbide-tipped tools (not shown). Use wet or dry. Silicone carbide.

Size (inches)	Grit	Arbor Hole (inches)	Catalog Number	Wt. (lbs. oz.)	Price
6x1/2	100	1/2-in.	9 R 64242	1 1	\$8.99

(12) For sharpening high-speed steel router bits. Use with (6). Aluminum oxide.

Size (inches)	Grit	Arbor Hole (inches)	Catalog Number	Wt. (lbs. oz.)	Price
5x1/2	...	1/2	9 R 64255	12	\$8.49
6x1/2	...	1/2	9 R 64256	1 2	8.69
7x1/2	...	1/2-5/8	9 R 64257	1 11	9.69

For sharpening woodboring bits and carbide-tipped masonry bits (not shown). Use with (7). Silicone carbide.

Size (inches)	Grit	Arbor Hole (inches)	Catalog Number	Wt. (lbs. oz.)	Price
5x1/2	...	1/2	9 R 64258	11	\$8.59
6x1/2	...	1/2	9 R 64259	1 1	8.79
7x1/2	...	1/2-5/8	9 R 64261	1 12	9.99

(13) Flexible-flap Sanding Wheel for wood, rust removal, grinding and polishing metals, fiber glass... even on contoured surfaces. Adapter for portable drill.

Size (inches)	Grit	Arbor Hole (inches)	Catalog Number	Wt. (lbs. oz.)	Price
6x1	Fine	1/2	9 R 64868	10	\$12.99
6x1	Medium	1/2	9 R 64869	10	11.99

(14) Commercial Production Wire Wheel. Heavy-duty carbon steel. Use for removal chores.

Size (inches)	Grit	Arbor Hole (inches)	Catalog Number	Wt. (lbs. oz.)	Price
6x3/4	...	1/2-5/8	9 R 64129	1 14	\$12.99
6x3/4	...	1/2-5/8	9 R 64814	1 14	13.99

(15) Wire Wheels to remove rust, paint.

Size (inches)	Grit	Arbor Hole (inches)	Catalog Number	Wt. (lbs. oz.)	Price
4x7/8	Fine	1/2-3/8*	9 R 64811	11	\$4.49
4x7/8	Fine	1/2-3/8	9 R 64823	11	4.49
5x1/2	Fine	1/2-3/8*	9 R 64818	10	4.99
6x1/2	Fine	1/2-3/8	9 R 64824	15	5.49
7x1/2	Fine	1/2-3/8	9 R 64815	1 3	6.99
5x1/2	Coarse	1/2-3/8*	9 R 64819	11	4.99
6x1/2	Coarse	1/2-3/8	9 R 64812	15	5.49
7x1/2	Coarse	1/2-3/8	9 R 64816	1 3	6.99
8x1 1/2	Coarse	1/2-3/8	9 R 64813	1 10	7.49
6x1	Coarse	1/2-3/8	9 R 64834	1 12	9.49
8x1 1/2	Coarse	1/2-3/8	9 R 64835	3	12.99

\*Bushed to fit.

16 Pro-quality Buffing Wheels of 100% industrial-grade cotton. Use compounds sold at left.

9 R 64938—4-in. diam., 1/2-in. hole. Wt. 3 oz. . . \$2.69

9 R 64939—6-in. diam., 1/2-in. hole. Wt. 4 oz. . . 3.19

9 R 64941—8-in. diam., 3/8-in. hole. Wt. 6 oz. . . 3.79

Buffing Compound Set. Four 3-oz. bars: emory (black), red rouge, white, Tripoli (brown).

9 R 2896—Shpg. wt. 1 lb. 7 oz. . . Set \$2.29

**These Electronic Drills  
(1 and 2) are sold  
exclusively at Sears**

- Electronic feedback controlled speed remains constant under load for even drilling

**2/5-HP, 3/8-inch  
variable-speed  
Reversible Drill**



**1/3-HP, 1/2-inch square-drive  
Reversible Impact Wrench**

- Develops up-to 180 ft./lb. torque to fulfill heaviest loosening/tightening needs

3



- Delivers 4000 blows per minute at 2000 rpm for fast tightening/loosening

# Sears Best

- Adjustable variable-speed trigger locks in on the speed of your choice!

- Sears exclusive auto-chuck uses drill's own power to tighten and loosen bits. No need for chuck keys!

2



**1/2-inch, 3/4-HP  
variable-speed  
Reversible Drill**

**3/8-HP, 3/8-inch  
variable-speed  
Reversible Rotary  
Hammer Drill**

- Switches from rotary to hammer action with a twist of the selector ring

4



- Adjustable depth stop rod allows precision setting of drilling depth



• New vinyl foam-coated front boot protects work surface

# The Best Consumer Portable Electric Tools we've ever sold!

We took our Sears Best CRAFTSMAN® Portable Electric Tools and made them better than ever! Here's how...

## NEW!

Precision balanced motors  
—operate quieter  
—transmit less vibration

## NEW!

Improved bearing structure  
—precision grade ball bearings  
—longer tool life

## NEW!

Improved gearing  
—cut steel gearing  
for strength, durability

## NEW!

10-foot cord with our unique plug design

ONE QUALITY NAME

**CRAFTSMAN**

OFFERS MORE GOOD CHOICES

Our CRAFTSMAN® tools are put to the test!! They're tested against our high standards for quality CRAFTSMAN® tools. Only when they exceed those standards are they called Sears Best!

Not only are tests simulated before production, production tools are subjected to a broad range of stresses, drop tested and checked for function and electrical safety. Then, Use Test technicians use production tools around the clock to verify they'll withstand the stresses encountered in real life use

Exacting parts measurement is another example of the tough standards our tools must meet. The components in Sears Best tools are critically measured to manufacturing tolerances with state of the art measuring equipment

While some competitive portable electric tools use pressed or cast gears, The gears in Sears Best tools are precision cut from alloy steel blanks in precise alignment on the shaft to which it is mounted. Tighter tolerances on Sears Best tool shafts and improved bearing to shaft fit-up make a smoother, quieter, longer running tool than our previous best tools



One of the most incredible features on our new line of Sears Best portable electric tools is that once you start using them, you'll actually feel the difference... less noise, less vibration and an even higher quality performance than our previous Sears Best.

Inside, each armature is rotated at high speed and machine analyzed for precision balance. Outside, sheet metal parts in Sears Best tools are protected for long-term use with a wear-resistant, friction-reducing epoxy finish. And now they have a 10-ft. power cord that's actually a whopping 60% longer than cords used on most other consumer portable electric tools. The cord stays flexible in cold weather and its unique plug design (patent pending) helps prevent snagging. Molded cord clip makes cord storage easier. Warranted.\*

\*Warranted by Sears. Write for free copy, see page 148. Tools are double-insulated, need no grounding.

1 Adj., variable-speed of 0-1200 rpm. Dual position auxiliary handle for more control. Helical/spur gearing. Bits not incl., sold on p. 100 and 101. 9 R 10402—Shpg. wt. 5 lbs. 10 oz. . . \$77.99

2 Adj., variable-speed of 0-600 rpm. 4 position rear handle; 3 position aux. handle. Helical/spur gearing. Bits not incl., sold on p. 100 and 101. 9 R 10504—Shpg. wt. 7 lbs. 5 oz. . . \$97.99

3 Die-cast aluminum gear case for added durability. Planetary gears for long life; sleeve bearings. 9 R 18301—Shpg. wt. 7 lbs. 7 oz. . . \$97.99  
Save \$10. Impact wrench (3) with case (not shown) (9 R 1474) and chuck (9 R 2253) which converts wrench to drill. Sep. prices total \$139.97. 9 R 18306—Shpg. wt. 13 lbs. 8 oz. . . \$129.97

4 Rotary hammer drill provides 0 to 1200 rpm in drill mode or up-to 25,200 blows per minute in the hammer mode for fast results. Reverses in drill mode only. Helical/spur gears; ball, roller, sleeve bearings. 9 R 11411—Shpg. wt. 6 lbs. 7 oz. . . \$97.99



**2¾-HP, 7¼-inch Circular Saw**

- Our most powerful consumer circular saw!
- Deluxe rip guide with width of cut scale so you can set width without a tape measure
- Spindle lock for fast blade changes
- Includes our most popular, 18-tooth carbide-tipped blade



**1½-HP, Electronic Multi-speed Router**

- Electronic feedback control senses speed loss under load and provides additional power to maintain selected speed
- Multiple speeds from 15,000 to 25,000 rpm matches cutter speed to wood hardness for best finish cut
- Front mount automatic shaft lock for simple bit changes

# Sears Best

ONE QUALITY NAME  
**CRAFTSMAN**<sup>®</sup>  
 OFFERS MORE GOOD CHOICES

**¾-HP, 3½-inch Power Planer**

- No-load speed of 15,000 rpm provides 30,000 cuts per minute in virtually any type of wood
- Contoured depth of cut adjustment knob provides easy settings from 0 to ⅛-inch
- Twin blade cutter with money-saving reversible high-speed blades provides new cutting surface when original edge dulls



**½-HP, ½ sheet Pad Sander**

- Vibration dampening reduces vibration to operator without affecting tool performance
- Internal aluminum bearing frame extends tool life
- For comfort, exclusive vinyl foam-coated handle
- Dual-motion for versatility
- Convenient dust pick-up system
- Uses adhesive-backed or standard sandpaper



**½-HP, variable-speed Sabre Saw**

- Automatic scrolling device allows blade to pivot 360°... permits single-handed operation when cutting curves
- Dust blower keeps cutting line clear

1/4-HP, 4-inch Belt Sander



- Sears unique state-of-the-art Memory-Trak belt alignment system keeps belt running in original position without annoying adjustments
- Built-in dust collector helps keep work area clear
- Large, 19 square inch sanding surface covers area faster than our other consumer sanders

3/4-HP, electronic Reciprocating Saw



- Adjustable variable speeds of 0 to 2500 strokes per minute for fast cutting in a variety of materials
- Electronic feedback control maintains speed under normal loaded conditions
- Looped contoured rear handle with front body grip provides comfortable, positive control of saw

9-inch, 2-HP Disc Grinder

- Contains our most powerful non-industrial disc grinder motor!
- Large wheel and guard are ideal for heavy-duty grinding needs . . . can be used as a sander with optional sanding kit
- Dual position auxiliary handle mounts on either side for better control



For some, only the best tools will do. With this in mind, we've redesigned our finest consumer tool line. We not only made them our best, we made them

**Better than any consumer portable electric tools we've ever sold!**

**NEW!**

Precision balanced motors  
—Operate quieter,  
—transmit less vibration

**NEW!**

Improved bearing structure  
—Premium grade ball bearings  
—longer tool life

**NEW!**

Improved gearing  
—Cut steel gearing for strength, durability

**NEW!**

—10-foot cord with our unique plug design

These tools have the same incredible features as the Sears Best tools on page 95. Warranted.\*

1 This circular saw is loaded with convenient features. Knob and lever controls for easy bevel and depth of cut adjustment. Push-button arbor lock. Wrench stores in base. Cuts 0-2 1/4-in. deep at 90°, 0-1 3/4-in. at 45°. Base and edge guide have epoxy coat paint for durability. Helical gears; die-cast aluminum gear case; blade guards allow use of cut-off wheels. Ball and roller bearings.  
9 R 10925—Wt. 13 lbs. 14 oz. . . \$74.99

2 This router's ring-type depth adjustment in 1/64-in. increments allows fast, accurate changes; zero reset allows precise depth settings. Dual contoured handles for positive control. Built-in worklight; chip shield. Ball bearings.  
9 R 17477—Wt. 8 lbs. 3 oz. . . \$77.99

3 This belt sander's no-load speed of 1300 feet per minute and 19 sq. in. sanding surface covers large areas quickly. Locking trigger switch for continuous operation. Lever-type belt tensioner simplifies belt changes. Uses 4x21-in. belts. Ball bearings.  
9 R 11792C—Wt. 18 lbs. . . \$97.99

4 Our planer's full 3 3/8-in. wide cutter can plane a 2x4 in one pass! 0 to 1/16-inch depth of cut. Cogged timing belt drive. Trigger switch. Incl. edge guide and door bevel fence. Ball bearings.  
9 R 17372—Wt. 10 lbs. . . \$97.99

Replacement blades for (4). Pkg. of 2.  
9 R 17323—Wt. 1 oz. . . Pkg. \$8.99

\*Warranted by Sears. Write for free copy, see page 148.

Tools are double-insulated. Need no grounding.

5 This 3/4-inch blade stroke sabre saw with adjustable, variable speeds of 0-3000 strokes per minute allows matching of blade speed to material being cut for best results. Detented base provides quick indexing to common angles. Trigger switch locks on. Incl.: edge guide/circle cutting attachment; hex key and key holder services both base, blade . . . simplifies blade changing and base setting. Spur gearing; ball bearings.  
9 R 17211—Wt. 6 lbs. 10 oz. . . \$67.99

6 Operating at 4000 orbits or strokes per minute, this pad sander's orbital mode provides fast material removal while its straight-line mode produces a fine finish similar to more tedious hand sanding. Sealed push-button switch. Uses 1/2 sheet 4 1/2 x 9 1/8-in. or 4 1/2 x 11-in. sandpaper. Light weight and less vibration reduces operator fatigue. Ball, roller, sleeve bearings.  
9 R 11616—Wt. 5 lbs. 12 oz. . . \$67.99

7 Looking for the cutting tool that can provide the power for household chores from pruning to remodeling? Look no further . . . this reciprocating saw with blade and case can handle it. Four position front shoe for versatility. 1-inch blade stroke; wrench incl. Adjustable trigger switch with lock. Helical and bevel gears; ball, roller, sleeve bearings.  
9 R 17102—Wt. 11 lbs. 7 oz. . . \$97.99

8 Power thru grinding chores at 4600 rpm no-load speed. Trigger switch locks on for operator convenience. Spindle lock provides quick, simple accessory changes. Raised aluminum pad tool rest. Spiral bevel gears; ball and roller bearings.  
9 R 11502—Wt. 13 lbs. 15 oz. . . \$114.99

9-in. sanding kit for (8) incl. rubber back-up pad, lock nut.  
9 R 11159—Shpg. wt. 1 lb. . . \$12.99

Get a CRAFTSMAN® Drill that'll do your job and more . . . we've staked our reputation on it with a full one-year warranty!\*

CRAFTSMAN® versatile 3/8-inch Reversible Drills



**2** Available in Catalog only!  
1/8-HP variable-speed Drill  
**\$44<sup>99</sup>**



**3** 1/4-HP variable-speed Drill  
**\$27<sup>99</sup>**



**4** 1/8-HP single-speed Drill  
**\$18<sup>99</sup>**

These powerful CRAFTSMAN® 1/2-inch Drills are ready for the toughest jobs you have in mind



**5** 1/2-HP single-speed Drill  
**\$47<sup>99</sup>**



**6** 3/8-HP adjustable, variable-speed Drill works in steel, brick and concrete  
**\$57<sup>99</sup>**



ONE QUALITY NAME  
**CRAFTSMAN**  
OFFERS MORE GOOD CHOICES

Our 2/5-HP Drill has auto-chuck for quick bit changes without a key!  
**\$57<sup>99</sup>**



**7** Replacement Keys and Chucks  
**8** 3-jaw heavy-duty steel replacement chucks. Fits 3/8-in. x 24 thread. 1/2 in. to 3/4 in. cap.  
**9** Case

**1** Removable side handle plus Sears exclusive auto-chuck. Locking adj. trigger switch; 0 to 1200 rpm variable, no-load speed. 2-position auxiliary handle. Double reduction helical, spur gearing. Permanently lubricated ball, roller and sleeve bearings. Warranted.\* 9 R 10419—Wt. 5 lbs. 7 oz. . . \$57.99

This drill (not shown) has same features as (1) above, except has regular chuck.  
9 R 1041—Wt. 5 lbs. 12 oz. . . \$47.99

**2** Our 1/8-HP drill has adjustable variable-speed trigger. Double-reduction helical/spur gearing for smooth power transfer. Permanently lubed ball, sleeve bearings. Pin type spindle lock. Warranted.\* 9 R 1051—Wt. 4 lbs. 5 oz. . . \$44.99

This drill (not shown) has all the features of (2) except has perm. lubed sleeve bearings and variable speed trigger.  
9 R 1049—Wt. 4 lbs. 5 oz. . . \$37.99

**3 and 4** 3/8-in. capacity chuck threaded for 3/8-in. x 24 spindle. Warranted.\*

**3** 1/4-HP drill with locking trigger switch, double-reduction spur gearing. 0 to 1200 rpm no-load speed. Perm. lubed sleeve bearings. 9 R 1004—Wt. 3 lbs. 6 oz. . . \$27.99

**4** Perm. lubed sleeve bearings. Double-reduction spur gearing. 9 R 1001—Wt. 3 lbs. 6 oz. . . \$18.99

**5 and 6** Geared chuck threaded for 1/2x20 spindle. Warranted.\*

**5** No-load speed of 600 rpm. Sleeve bearings. Triple-reduction spur gearing. Side handle. 9 R 1027—Wt. 5 lbs. 13 oz. . . \$47.99

**6** Variable no-load speeds of 0 to 600 rpm. Removable top handle. 4-position "D" grip handle adds balance. Perm. lubed ball, sleeve bearings. Double-reduction helical, spur gears. 9 R 1028—Wt. 6 lbs. 4 oz. . . \$57.99

**7** Heavy-duty steel chuck keys for electric drills.

Fits Jacob chuck	Fits Supreme chuck	Fits Sears chuck	Catalog Number	Wt. oz.	Price each
1, 1A, 1BS, 7, 7B	1A, 1T1	9-2972	9 R 2051	1	\$1.89
	H17A, 4A, 4B	9-2979	9 R 2073	1	1.89
	4C, 4T1, 4T2	9-2976			
7-1A					
MC1, 2	B1A, B80A, B1A, B80A	9-2975	9 R 2058	1	1.29
	B16A, B16T33	9-29721			
MC4K61	B13A, B14T33, B14B, B16B, B16A, B16T33	9-2973	9 R 2059	4	1.29

Cord lock (not shown) keeps tool cord and extension cord together.  
9 R 2595—Shpg. wt. 2 oz. . . \$1.09

\*Warranted to give complete satisfaction. 90 days commercial, rental. Write for free copy, see p. 148.  
NOTE: Drills are double insulated, need no grounding. 6-ft., 2-wire cord. Drill bits not incl.

**8** 3-jaw heavy-duty steel replacement chucks. Fits 3/8-in. x 24 thread. 1/2 in. to 3/4 in. cap.

9 R 2975—Wt. 7 oz. . . \$7.99

Fits 1/2 in. x 20 thread. 3/4 to 1 1/2 in. capacity.  
9 R 2980—Wt. 13 oz. . . \$10.99

Chuck key holder keeps keys on cord (not shown).  
9 R 2978—Wt. 1 oz. . . 39¢

Chuck key for other 3/8 in. electric drills (not shown).  
9 R 2149—Wt. 1 oz. . . \$2.49

**9** Permanex® polyethylene tool case will not rust or corrode.  
9Lx14 1/2Wx4 1/2-in. D. Wt. 1 lb. 12 oz.  
9 R 1477. . . Case alone \$9.99  
When you also buy any drill . . . \$7.49

Large tool case. Sim. to (9) except 17 3/4Lx10 1/2Wx12 3/4 in. deep.  
9 R 1474—Wt. 4 lbs. 12 oz. . . \$16.99  
When you also buy any drill . . . \$12.74

See our Sears Best Drills on pages 96, 97. Be sure to check the large variety of drill bits and accessories on pages 99, 102.



**1** Hole saws  
Available in Catalog only!  
7-pc. high-speed steel hole saw kit

**2** Pin-drive mandrel

**3** Mandrels with pilot set



**10** Crimped wire wheel brushes



Available in Catalog only!  
Heavy-duty contour sander brushes get into openings, curves, even corners!



Sanding/polishing/buffing kit for fine finishes on cars, wood, metal



Sander/polisher/buffer set has 2 handles for 2-hand control



**6** Hole-cutting kit lets you cut tile, cement, asbestos board and more



**7** Door lock installation kit



**8** 13-pc. hole saw kit  
Cut thick wood fast for installation of pipe with plumber's bits



Available in Catalog only!  
This wood-turning attachment converts your drill into a wood-working lathe  
**\$24<sup>99</sup>**



**14** Bit bandolier  
New at Sears!  
Cordless drill and screwdriver holster



**16** Slim in-line cordless stick screwdriver holster



**19** Drill press work arbor  
**20** Nail spinner sets nails as easily as screws



Available in Catalog only!  
Sand orate chairs, table legs and furniture parts with this refinishing kit  
**\$19<sup>99</sup>**

**With the right accessories, your drill could become the most versatile tool in the workshop!**

Carbide-tipped saws last 5 times longer than hi-speed steel saws on metal. Cut abrasive materials. Use with mandrels (5).

Diam.	Catalog No.	Wt.	Price
3/4 in.	9 R 64108	1 oz.	\$6.99
7/8 in.	9 R 64109	1 oz.	7.49
1 1/8 in.	9 R 64111	1 oz.	7.99
1 in.	9 R 64112	2 oz.	7.99
1 1/4 in.	9 R 64113	2 oz.	8.79
1 1/2 in.	9 R 64114	3 oz.	9.29
1 3/4 in.	9 R 64115	4 oz.	10.19
1 7/8 in.	9 R 64116	5 oz.	10.59
2 in.	9 R 64117	4 oz.	10.99
2 1/4 in.	9 R 64118	4 oz.	11.49
2 1/2 in.	9 R 64119	4 oz.	11.49
2 3/4 in.	9 R 64121	4 oz.	12.99
2 1/2 in.	9 R 64122	5 oz.	13.69

Hi-speed steel cut machineable steel, brass, plastics, wood, aluminum and iron. Use with mandrels (5).

Diam.	Catalog No.	Wt.	Price
3/4 in.	9 R 25777	1 oz.	\$4.99
7/8 in.	9 R 25771	1 oz.	4.99
1 in.	9 R 25772	2 oz.	5.49
1 1/8 in.	9 R 25773	2 oz.	5.99
1 1/4 in.	9 R 25774	3 oz.	5.99
1 1/2 in.	9 R 25775	3 oz.	6.29
1 3/4 in.	9 R 25776	4 oz.	6.99
1 7/8 in.	9 R 25777	2 oz.	8.29
2 in.	9 R 25778	3 oz.	8.59
2 1/2 in.	9 R 25779	5 oz.	8.99
3 in.	9 R 25791	6 oz.	11.49
3 1/2 in.	9 R 25792	8 oz.	11.99
4 in.	9 R 25793	9 oz.	12.29
4 1/4 in.	9 R 25794	10 oz.	14.99

5-pc. heat-treated tool steel hole saw kit. Saw sizes 1/4, 1/2, 3/4, 2 1/2 in. Incl. No. 2 med.-duty mandrel.  
9 R 25240—Wt. 8 oz. . . Kit \$9.99

7-pc. high-speed steel hole saw kit. Saw sizes: 3/8, 1, 1 1/8, 1 1/4, 1 1/2 in.; 1/4-in. round arbor; 1/4 inch arbor adapter; plastic case.  
9 R 25765—Wt. 1 lb. 4 oz. . . \$34.99

For heavy-duty use . . . has no-slip pin drive. For 3/4 to 4 1/4-in. saws. Includes pilot bit.  
9 R 25628—Wt. 10 oz. . . \$10.99

5 Mandrels include pilot bit. Fit these saws (inches in diameter).

Carbide-tipped	Hi-speed Steel	Catalog Number	Price, Each
Size No. 1, 3/8-in. shank	Wt. 2 oz.	9 R 25626	\$4.99
3/4 to 1 1/2	3/4 to 1 1/2	9 R 25627	\$6.99
Size No. 2, 7/8-in. shank	Wt. 2 oz.		
1 1/4 to 2 1/2	1 1/4 to 4 1/4	9 R 25627	\$6.99

Replacement pilot bit for (5).  
9 R 25629—Wt. 6 oz. . . \$2.49

Fits 1/4-in. or larger drills. Incl. 1, 1 1/4-in. diam. carbide-tipped hole saws and mandrel with 1/4-in. masonry pilot bit; mandrel adapter with washer, 1/8x3-in. masonry bit, case.  
9 R 25752—Wt. 1 lb. 2 oz. . . Kit \$19.99

For installation of locks in wood doors. Incl. 2 1/8, 1 1/2, 1 1/4-in. hole saws; mandrel; 1 1/2-in. wood bit.  
9 R 25751—Wt. 14 oz. . . \$9.99

This hole saw kit cuts holes for piping, cuts tubing, conduit and cable. Kit incl. 9 bi-metal, high-speed steel hole saws sizes: 3/4, 7/8, 1 1/8, 1 1/4, 1 1/2, 1 3/4, 2, 2 1/4, 2 1/2-in.; 1/4-in. round arbor; 7/8-in. hex pin drive arbor; 1/4-in. arbor adapter; 1/4-in. pilot bit; plastic case, Shpg. wt. 3 lbs. 5 oz.  
9 R 25763 . . . Kit \$79.99

Available in Catalog only!  
Plumber's bits. Screw center, self feeding.

Diam. in.	Lgth. in.	Hex Shank	Catalog Number	Wt. oz.	Price
1 1/4	2 1/4	7/8	9 R 20941	6	\$18.99
2 1/4	2 1/4	7/8	9 R 20942	8	19.99
2 1/4	2 1/4	7/8	9 R 20943	8	20.99
2 1/4	2 1/4	7/8	9 R 20944	10	21.99
1 1/2	2 1/4	3/4	9 R 20936	3	13.99
1 1/4	2 1/4	3/4	9 R 20937	3	14.99
1 1/2	2 1/4	3/4	9 R 20938	3	15.99
1 1/2	2 1/4	3/4	9 R 20939	4	16.99

Extensions (not shown)

Size in.	Hex Shank	Catalog Number	Wt. oz.	Price
4	3/8-in.	9 R 20940	3	\$6.99
4	7/8-in.	9 R 20950	3	6.99

3-in. diam. 1/4-in. steel shank fits 3/4-1/2-in. drills. Max. safe speed 4,500 rpm. Wt. 6 oz.

Wire	Gauge	Catalog No.	Price
Fine	006-in.	9 R 64902	\$4.49
Coarse	012-in.	9 R 64903	4.49

Fits 1/4, 3/8-in. drills. Incl. wheel with 1/4-in. shank, abrasive coil. 8 brushes 6-in. diam. x 1-in. w. strips.  
9 R 64858—Wt. 2 lbs. . . \$12.99

Abrasive refills for (11) above.

Grit	Catalog No.	Wt.	Price
Coarse	9 R 64862	1 oz.	\$2.49
Medium	9 R 64863	3 oz.	2.99
Fine	9 R 64864	1 oz.	2.99

Swivel joint in back-up pad flexes to 30° angle for fine sanding. Fits 1/4 to 1/2-in. drills. Incl. 6-in. diam. rubber back-up pad, 1/4-in. diam. shank, three 6-in. alum.-oxide discs (fine, med., coarse), glue, 6-in. wool/polyester polishing bonnet.  
9 R 28418—Wt. 1 lb. 3 oz. . . \$9.49

Fits 1/4, 3/8-in. drills. 2:1 gear ratio to polish; 1:2 to sand. Includes 2 position handle; chuck adapter, 5-in. rubber back-up pad, wool polishing bonnet, 6 sanding discs.  
9 R 26272—Wt. 1 lb. 6 oz. . . \$9.99

9-pc. bandolier stores power driver bits for 1/4-in. or larger variable speed drills or cordless screwdrivers. Inc. 5-6, 8-10, 10-12 slotted; P-1, P-2, P-3 Phillips, R-1, R-2 Robertson bits; magnetic chuck.  
9 R 25668—Wt. 8 oz. . . \$5.99

Like above, except attaches to most belts.  
9 R 25666—Wt. 8 oz. . . \$5.99

Heavy-duty top grain leather. Incl. safety straps, 2-pocket suede leather bit holders. Fits pistol-grip cordless screwdrivers 9-11120, 11124.  
9 R 66845—Wt. 4 oz. . . \$12.99  
Fits 3/8-in. cordless drills 9-11125, 11126, 11127, 11128, 11132.  
9 R 66847—Wt. 5 oz. . . \$12.99

Slim in-line cordless stick screwdriver holster of heavy-duty top grain leather fits 9-11123.  
9 R 66849—Wt. 4 oz. . . \$9.99

Refinishing kit is ideal for ornate furniture. Styrene housing; nylon cam; steel U-bolt. Incl. 3 strips of sandpaper; polishing strap; compound. Use with 1/4, 3/8-in. drill.  
9 R 6670—Wt. 1 lb. 10 oz. . . \$19.99

Drill-operated wood-turning attachment can turn wood up to 16 inches long, 3 to 4 1/2-inch diameter. Performance may vary according to power of your drill. Drill held to headstock with mounting clamp. Leveling adjustment screw headstock. Tailstock with leveling feature slides along tubular rails length of workpiece, locks. Adjustable tool rest; 6x30x3/4-in. thick fiberboard base. Includes hardware.  
9 R 6655C—Wt. 8 lbs. . . \$24.99

Fits 1/2-in. drill chuck, 1/2-20 threads. Use buffing wheels to 8-in. diameter or with sanding drum 9-25246.  
9 R 24645—Wt. 5 oz. . . \$10.99

Available in Catalog only! Nail spinner lets you set finishing nails without pre-drilling or pounding. Unit chucks firmly into your 1/4 or 3/8-inch drill (not included). Use 4, 6, 8 or 10-penny finishing nails (not included).  
9 R 2601—Wt. 2 oz. . . \$3.99

NOTE: drills, chucks, bits not incl. with accessories sold on this page. See pages 94, 95, 100 thru 102, and 114.

# CRAFTSMAN® Drill Accessories are

**These Titanium-nitride Bits are the finest drill bits we've ever sold!**

Their exclusive coating not only makes them ideal for a wide range of materials, they last an incredible 12 times longer than any other bit we sell!



**1** Available in Catalog only! Our finest drill bits have specially designed split-point tips which drill without "walking"; require less pressure for quick penetration. An advanced technological process applies titanium-nitride coating to high-speed steel... improves chip flow, reduces heat build-up. When resharpened, coating maintains its resistance to corrosion, abrasion.

Diam. in.	Lgth. in.	Catalog Number	Wt. oz.	Price
1/16	1 7/8	9 R 66885	1	\$1.29
3/32	2 1/4	9 R 66886	1	1.49
1/8	2 3/4	9 R 66887	1	1.69
5/32	3 1/8	9 R 66888	1	1.99
3/16	3 1/2	9 R 66889	1	2.39
7/32	3 3/4	9 R 66890	1	2.99
1/4	4	9 R 66891	1	3.29
5/16	4 1/4	9 R 66892	1	4.59
3/8	4 1/2	9 R 66893	2	5.29
7/16	4 3/4	9 R 66894	2	5.99
1/2	5	9 R 66895	2	6.99
5/8	5 1/4	9 R 66896	2	8.49
3/4	5 1/2	9 R 66897	3	8.99
7/8	5 3/4	9 R 66898	3	10.99
1	6	9 R 66899	4	12.99

**2** 6-pc. Titanium-nitride Drill Bit Set incl. sizes: 1/16, 1/8, 3/16, 1/4, 5/16, 3/8-in. Sep. prices total \$20.94. 9 R 66683—Wt. 4 oz. Set \$14.99

## High-speed specialty and general purpose Bits

**Silver and Deming large diameter Bits**

**3** Available in Catalog only! CRAFTSMAN 8-pc. Silver and Deming Large-diam. Drill Bit Set of high-speed steel has reduced 1/2-in. shank for use with large diam. drills, drill presses. Black oxide finish acts as lubricant. Incl. 3/16, 1/4, 1/2, 3/4, 1 1/8, 1 1/2, 1 3/4 and 1-in. diam. sizes with 6-in. overall length and vinyl pouch. For 1/2-in. drill chuck. Wt. 3 lbs. 13 oz. 9 R 6748... Set \$129.99

**Cobalt Bits for hardest materials**

**4** Available in Catalog only! CRAFTSMAN Cobalt Drill Bits have a heavy-duty rigid construction that's just right for the very hardest metals such as steel alloys, stainless steel, chrome, armor plate, titanium alloys. Strength lies in the cobalt high-speed steel construction that allows these bits to withstand the heat generated when drilling high-tensile strength (or hard) metals. Has 135° split-point tip so bit won't "walk" on flat surfaces.

Diam. in.	Catalog Number	Wt. oz.	Price each
1/16	9 R 66943	1	\$1.89
1/8	9 R 66944	1	1.99
3/16	9 R 66945	1	2.59
1/4	9 R 66946	1	3.89
5/16	9 R 66947	1	5.99
3/8	9 R 66948	1	7.99

**6-pc. Cobalt Drill Bit Set incl. bits above. Separate prices total \$24.34. 9 R 6737—Wt. 5 oz. Set \$19.99**

**Extra-length 12-Inch Bits for work in hard-to-reach places**

**5** CRAFTSMAN Extra-length 12-in. Drill Bits are ideal for hard-to-reach locations or extra-thick materials. 9-in. flutes let you drill all the way thru. Precision-ground high-speed steel; black-oxide finish makes bits ideal for metals, wood, plastics.

Diam. in.	Catalog Number	Wt. oz.	Price, each
1/8	9 R 66881	1	\$12.99
1/4	9 R 66882	2	14.99
3/8	9 R 66883	4	19.99
1/2	9 R 66884	7	24.99

**4-pc. Extra-length Drill Bit Set includes all 4 bits above. Separate prices total \$72.96. 9 R 6741—Wt. 14 oz. Set \$59.99**

**6** 20-pc. Micro Drill Bit Set has small diameter sizes for precision drilling. Best used in a collet arrangement or special 3-jaw chuck providing high rpm reliability (5 to 20,000 rpm). Ideal for delicate workmanship, electronic, watch repair and making small nozzle holes. Wires nos. 61 thru 80. Sizes .039 thru .0135-in. (.35 to 1 mm). Precision-ground high-speed steel. Metal case. 9 R 6744—Wt. 2 oz. Set \$29.99



**20-pc. Micro Bit Set for precision drilling**

**7 thru 12** CRAFTSMAN high-speed steel drill bits are built so tough, they exceed Federal Specifications GGG-D-751 for strength. Self-lubricating black oxide finish and point accuracy to .002-inch tolerance make them ready for any job.

### STANDARD Drill Bit Sets... jobber length

Pcs. per Set	Catalog Number	Sizes, inches (Sizes marked with "X" included in set)																				Shpg. wt. lbs. oz.	Sep. prices total	Set price				
		1/16	3/32	1/8	5/32	3/16	1/4	5/16	3/8	1/2	5/8	3/4	7/8	1	1 1/8	1 1/4	1 1/2	1 3/4	2	2 1/2	3							
7†	9 R 6803	X	X	X	X	X	X	X	X	X	X	X	X	X	X	X	X	X	X	X	X	X	X	X	X	4	\$7.63	\$6.99
10†	9 R 6805	X	X	X	X	X	X	X	X	X	X	X	X	X	X	X	X	X	X	X	X	X	X	X	X	6	13.10	11.39
13†	9 R 6807	X	X	X	X	X	X	X	X	X	X	X	X	X	X	X	X	X	X	X	X	X	X	X	X	7	21.77	19.99
15†	9 R 6809	X	X	X	X	X	X	X	X	X	X	X	X	X	X	X	X	X	X	X	X	X	X	X	X	8	29.75	24.99
17†	9 R 6811	X	X	X	X	X	X	X	X	X	X	X	X	X	X	X	X	X	X	X	X	X	X	X	X	10	39.43	29.99
21†	9 R 6813	X	X	X	X	X	X	X	X	X	X	X	X	X	X	X	X	X	X	X	X	X	X	X	X	11	53.79	39.99
25†	9 R 6815	X	X	X	X	X	X	X	X	X	X	X	X	X	X	X	X	X	X	X	X	X	X	X	X	2	76.55	54.99
29†	9 R 6817	X	X	X	X	X	X	X	X	X	X	X	X	X	X	X	X	X	X	X	X	X	X	X	X	11	100.31	74.99

†Comes with fold-type case

‡Comes with index-type case

\*Turned-down shank fits 1/4, 3/8, 1/2-in. drills

**8** 115-pc. twist drill bit set incl. 60 wire-ga. bits, 1 thru 60; 29 fractional bits, 1/16 thru 1/2 in. by 64ths of an in.; 26 lettered bits, A thru Z and metal index case.

9 R 67115—Shpg. wt. 9 lbs. 2 oz. Set \$219.99

Metal Index-type case alone.

9 R 66853—Shpg. wt. 3 lbs. 12 oz. Set \$42.99

**9** Fold-type polystyrene case (bits not incl.). 9 R 66855—Shpg. wt. 1 lb. Set \$4.49

**10** 60-pc. wire gauge bit set. Sizes (1-60). Polystyrene case. 9 R 6819—Shipping weight 1 lb. 8 oz. Set \$49.99

**These high-speed General Purpose Bits are so strong, they even exceed Federal Specifications for strength!**



**7**



**8**

**9**

**10**

**11**

**12**

**11** Short-length Bits have turned-down shanks, fit 1/4, 3/8, 1/2-in. drills.

Diam.	Length	Catalog No.	Wt.	Each
3/16 in.	2 1/4 in.	9 R 66364	2 oz.	\$4.99
1/8 in.	3 in.	9 R 66365	2 oz.	5.49
1/8 in.	3 1/8 in.	9 R 66366	3 oz.	6.39
1/8 in.	3 3/4 in.	9 R 66367	4 oz.	7.69

**4-pc. turned-down shank bit set includes all bits in (11). Polystyrene case. Sep. prices total \$24.56.**

9 R 67184—Wt. 7 oz. Set \$19.99

**12** Large-diameter Bits. Turned-down shanks. Fit 1/2-in. drills. 6 in. long.

Diam.	Catalog No.	Wt.	Each
5/8 in.	9 R 67151	8 oz.	\$13.99
3/4 in.	9 R 67152	9 oz.	17.99
1 in.	9 R 67153	13 oz.	27.99

**3-piece Bit Set includes all 3 bits in (12). Sep. prices total \$59.97.**

9 R 67155—Wt. 1 lb. 14 oz. Set \$49.99

### Individual STANDARD Drill Bits

Diam.	Lgth. in.	Catalog Number	Wt. oz.	Price each	Diam. in.	Lgth. in.	Catalog Number	Wt. oz.	Price each
1/16 in.	1 7/8	9 R 66901	1	79c	1 3/8 in.	4 3/4	9 R 66936	1	\$3.09
3/32 in.	2	9 R 66902	1	89c	1 1/2 in.	4 1/2	9 R 66917	1	3.39
1/8 in.	2 1/4	9 R 66903	1	99c	1 1/4 in.	4 3/4	9 R 66918	2	3.69
3/16 in.	2 3/4	9 R 66904	1	\$1.09	1 1/2 in.	4 3/4	9 R 66919	2	3.99
1/4 in.	2 3/4	9 R 66905	1	1.19	1 3/8 in.	5 1/8	9 R 66934	2	4.29
5/16 in.	2 7/8	9 R 66906	1	1.29	1 1/2 in.	5	9 R 66921	2	4.59
3/8 in.	3 1/8	9 R 66907	1	1.39	1 3/8 in.	5	9 R 66922	6	4.99
1/2 in.	3 1/4	9 R 66908	1	1.49	1 3/8 in.	5 1/4	9 R 66923	2	5.39
5/8 in.	3 3/8	9 R 66909	1	1.69	1 3/8 in.	5 1/4	9 R 66924	2	5.69
3/4 in.	3 3/4	9 R 66910	1	1.79	1 3/8 in.	5 1/2	9 R 66925	3	5.99
1 1/8 in.	3 3/4	9 R 66911	1	1.89	1 3/8 in.	5 3/4	9 R 66926	3	6.89
1 1/4 in.	3 3/4	9 R 66912	1	1.99	1 3/8 in.	5 3/4	9 R 66927	3	7.39
1 1/2 in.	4	9 R 66913	1	2.29	1 3/8 in.	5 3/4	9 R 66928	4	8.39
1 3/4 in.	4 1/4	9 R 66914	1	2.49	1 3/8 in.	6	9 R 66929	4	8.39
1 7/8 in.	4 1/4	9 R 66915	1	2.49					
2 in.	4 1/4	9 R 66916	1	2.79					

**SHOP BY PHONE**  
To order, call your local Sears store

SearsCharge and Discover Card... each is different, but together they're all you really need

To apply for SearsCharge only CALL TOLL FREE 1-800-323-3274 IN ILLINOIS CALL 1-800-942-7446

# specially designed for your every job!

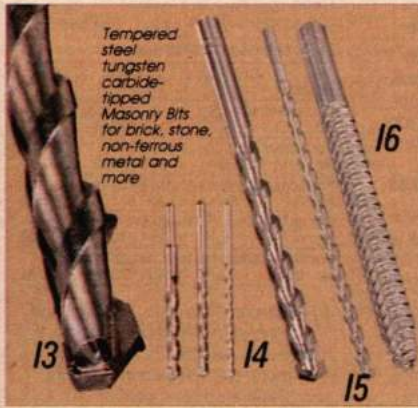

Tempered steel tungsten carbide-tipped Masonry Bits for brick, stone, non-ferrous metal and more

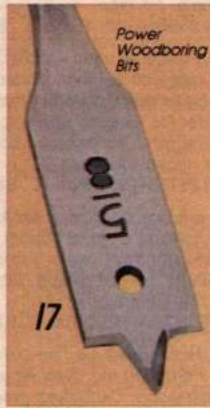

Power Woodboring Bits



12-pc. Woodboring Bit Set

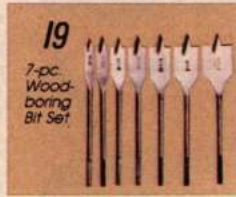

7-pc. Woodboring Bit Set



Spade Bit Pilot Set



Forstner-type Wood Drill Bits for precision flat bottom holes in many shapes

**13 thru 15** These bits are ideal for rotary percussion impact drills; have heat-treated shanks, milled flute shape.

**13** 6-inch long Impact Masonry Bits fit  $\frac{3}{8}$ -in. chucks except 9-67385 fits  $\frac{1}{4}$ -in.

Size	Catalog Number	Shpg. wt.	Price
$\frac{1}{4}$ in.	9 R 67385	2 oz.	\$1.99
$\frac{5}{16}$ in.	9 R 67386	2 oz.	2.49
$\frac{3}{8}$ in.	9 R 67387	3 oz.	2.99
$\frac{1}{2}$ in.	9 R 67388	4 oz.	3.49

**14** 4-pc. Bit Set incl. all 4 bits in (13). Sep. prices total \$10.96.

9 R 67389—Wt. 10 oz. . . . Set \$8.99

**15** 13-inch Impact Masonry Bits fit  $\frac{3}{8}$ -in. chucks except 9-67096 fits  $\frac{1}{4}$ -in.

Size	Catalog Number	Shpg. wt.	Price
$\frac{1}{4}$ in.	9 R 67096	4 oz.	\$4.99
$\frac{5}{16}$ in.	9 R 67097	5 oz.	5.49
$\frac{3}{8}$ in.	9 R 67098	6 oz.	5.99
$\frac{1}{2}$ in.	9 R 67099	7 oz.	6.99

**16** Individual Tungsten Carbide-tipped Bits.

Size	Shank	Lgth.	Catalog No.	Wt.	Each
$\frac{1}{8}$ in.	$\frac{1}{8}$ in.	3 in.	9 R 67084	1 oz.	\$1.49
$\frac{3}{16}$ in.	$\frac{3}{16}$ in.	3 in.	9 R 67085	1 oz.	1.59
$\frac{1}{4}$ in.	$\frac{1}{4}$ in.	4 in.	9 R 67086	1 oz.	1.69
$\frac{5}{16}$ in.	$\frac{5}{16}$ in.	4 in.	9 R 67087	1 oz.	1.99
$\frac{3}{8}$ in.	$\frac{3}{8}$ in.	4 in.	9 R 67088	1 oz.	2.29
$\frac{1}{2}$ in.	$\frac{1}{2}$ in.	6 in.	9 R 67325	4 oz.	2.99
$\frac{5}{8}$ in.	$\frac{3}{8}$ in.	6 in.	9 R 67088	6 oz.	4.49
$\frac{3}{4}$ in.	$\frac{3}{8}$ in.	6 in.	9 R 67089	8 oz.	4.99

7-pc. Bit Set incl. bits in (16) except  $\frac{1}{8}$ -in. Separate prices total \$20.03.

9 R 67347—Wt. 1 lb. 6 oz. . . . Set \$15.99

**17 thru 19** High-carbon, heat-treated steel have ground grooved points to bore 30% to 50% faster than non-ground bits. Bore with no-jump starts for smooth holes up to 5 in. deep at any angle. Fit any  $\frac{1}{4}$ -in. or larger drill, drill press.

**17** Individual Power Woodboring Bits

Size	Catalog Number	Shpg. wt.	Price
$\frac{1}{4}$ in.	9 R 20951	1 oz.	\$1.59
$\frac{5}{16}$ in.	9 R 20931	1 oz.	1.69
$\frac{3}{8}$ in.	9 R 20952	2 oz.	1.69
$\frac{7}{16}$ in.	9 R 20932	1 oz.	1.79
$\frac{1}{2}$ in.	9 R 20953	2 oz.	1.79
$\frac{5}{8}$ in.	9 R 20933	1 oz.	1.89
$\frac{3}{4}$ in.	9 R 20954	2 oz.	1.89
$\frac{1}{2}$ in.	9 R 20934	1 oz.	1.99
$\frac{3}{4}$ in.	9 R 20955	2 oz.	1.99
$\frac{1}{2}$ in.	9 R 20935	1 oz.	2.09
$\frac{3}{4}$ in.	9 R 20956	2 oz.	2.09
$\frac{1}{2}$ in.	9 R 20966	2 oz.	2.19
1 in.	9 R 20957	2 oz.	2.19
$\frac{1}{2}$ in.	9 R 20958	3 oz.	2.49
$\frac{1}{4}$ in.	9 R 20959	3 oz.	2.69
$\frac{1}{8}$ in.	9 R 20962	3 oz.	2.89
$\frac{1}{2}$ in.	9 R 20961	3 oz.	2.99

**18** 13-pc. Set.  $\frac{1}{4}$ ,  $\frac{3}{8}$ ,  $\frac{1}{2}$ ,  $\frac{5}{8}$ ,  $\frac{3}{4}$ ,  $\frac{7}{8}$ ,  $1\frac{1}{8}$  (for door locks),  $1\frac{1}{4}$ ,  $1\frac{3}{4}$ ,  $1\frac{7}{8}$ ,  $1\frac{1}{2}$  in. sizes. 6-in. ext. pouch. Sep. prices total \$29.57.

9 R 20963—Wt. 1 lb. 6 oz. . . . Set \$23.99

**6-pc. Set** Incl.  $\frac{3}{8}$ ,  $\frac{1}{2}$ ,  $\frac{5}{8}$ ,  $\frac{3}{4}$ ,  $\frac{7}{8}$ , 1-in. sizes. Sep. prices total \$11.64.

9 R 20964—Shpg. wt. 8 oz. . . . Set \$9.49

6-inch Extension alone (shown with set 18).

9 R 20968—Shpg. wt. 2 oz. . . . \$3.09

**19** Sears 7-pc. Woodboring Bit Set incl.  $\frac{3}{8}$ ,  $\frac{1}{2}$ ,  $\frac{5}{8}$ ,  $\frac{3}{4}$ ,  $\frac{7}{8}$ , 1,  $1\frac{1}{4}$  in. sizes and plastic pouch. For  $\frac{1}{4}$ -in. or larger electric drills. Imported. Not Craftsman. Wt. 11 oz.

9 R 2087 . . . Set \$8.99

**20** 5-pc. Spade Bit Pilot Set for use with woodboring bits to enlarge center point of hole, counterboring recessed area or drilling at an angle. Incl.  $\frac{1}{4}$ ,  $\frac{3}{8}$ ,  $\frac{1}{2}$ ,  $\frac{5}{8}$ ,  $\frac{3}{4}$ -in. sizes. Fits Craftsman woodboring bits or bits with center hole. Spring steel. Wt. 4 oz.

9 R 2588 . . . Set \$4.99

**CRAFTSMAN Carbon Steel Electricians' Bits** (not shown) are 18 in. long.

Bit Diameter	Fits Chuck
$\frac{1}{4}$ -in.	$\frac{1}{4}$ , $\frac{3}{8}$ , $\frac{1}{2}$ -in.
9 R 66931—Wt. 4 oz. . . .	\$11.99
$\frac{3}{8}$ -in.	$\frac{1}{4}$ , $\frac{3}{8}$ -in. or larger
9 R 66938—Wt. 6 oz. . . .	\$13.99
$\frac{1}{2}$ -in.	$\frac{3}{8}$ , $\frac{1}{2}$ -in. or larger
9 R 66932—Wt. 7 oz. . . .	\$14.99
$\frac{3}{4}$ -in.	$\frac{3}{8}$ , $\frac{1}{2}$ -in. or larger
9 R 66933—Wt. 8 oz. . . .	\$23.99

**21** Bores holes; half-holes, ovals and mortises. High-speed steel. Fit  $\frac{3}{8}$ -in. or larger chuck.

Size in.	Lgth in.	Catalog Number	Wt. oz.	Price Each
$\frac{3}{8}$	$\frac{1}{4}$	9 R 20976	3	\$7.99
$\frac{3}{8}$	$\frac{1}{4}$	9 R 20977	3	8.99
$\frac{3}{8}$	$\frac{1}{4}$	9 R 20978	3	9.99
1	$\frac{1}{4}$	9 R 20979	3	10.99
$1\frac{1}{8}$	$\frac{1}{4}$	9 R 20991	2	11.99
$1\frac{1}{4}$	$\frac{1}{4}$	9 R 20992	2	12.99
$1\frac{3}{8}$	$\frac{1}{4}$	9 R 20993	3	13.99
$1\frac{1}{2}$	$\frac{1}{4}$	9 R 20994	3	14.99
$1\frac{5}{8}$	$\frac{1}{4}$	9 R 20996	4	16.99
$1\frac{3}{4}$	$\frac{1}{4}$	9 R 20997	5	18.99
$1\frac{7}{8}$	$\frac{1}{4}$	9 R 20998	6	20.99
2	$\frac{1}{4}$	9 R 20999	6	21.99

4-piece Set incl.  $\frac{5}{8}$ ,  $\frac{3}{4}$ ,  $\frac{7}{8}$ , 1-in. bits. Sep. prices total \$37.96.

Shpg. wt. 10 oz.

9 R 20975 . . . Set \$32.99

4-in. Extension (not shown). For  $1\frac{1}{8}$ -in. or larger bits in (21).

9 R 20950—Wt. 3 oz. . . . \$6.99

4-in. extension (not shown). For 1-in. or smaller bits in (21).

9 R 20940—Wt. 3 oz. . . . \$6.99



29-bit capacity steel Bit Case

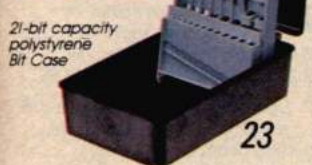

21-bit capacity polystyrene Bit Case

**22** Steel Bit Case will hold 29-pc. jobber-length bit set (not incl.) Lifting lid raises bits. Sizes by 64ths of an inch; decimal equivalents. Meets Federal Spec. GGG-C-116B; for durability.

9 R 66850—Wt. 1 lb. 8 oz. . . . \$5.49

**23** Polystyrene Bit Case will hold 21 bits (not included) in sizes by 64ths of an inch; decimal equivalents.

9 R 6838—Wt. 1 lb. 6 oz. . . . \$6.99

\*9 R 25833 . . . Wt. 2 oz.

**24** 30-pc. power screwdriver/nutdriver bit set with dial-a-bit case. Alloy tool steel bits fit  $\frac{1}{4}$ -in. or larger electric drills. Incl: 4 Torx® bits (Nos. T-15, 20, 25, 30); 4 Phillips bits (Nos. 0, 1, 2, 3); 3 sq. dr. bits (Nos. 1, 2, 3); No. 3 clutch bit; 5 hex bits ( $\frac{3}{16}$ ,  $\frac{1}{4}$ ,  $\frac{5}{16}$ ,  $\frac{3}{8}$ ,  $\frac{1}{2}$  in.); 2 slotted bits (5-6, 8-10); seven  $\frac{1}{4}$ -in. hex-shank power nut drivers ( $\frac{3}{16}$ ,  $\frac{1}{4}$ ,  $\frac{5}{16}$ ,  $\frac{3}{8}$ ,  $\frac{1}{2}$ ,  $\frac{5}{8}$ ,  $\frac{3}{4}$  in.); 2 plastic finders,  $\frac{1}{4}$ -in. magnetic holder.

9 R 25659—Wt. 1 lb. 1 oz. Set \$24.99

**25** 17-pc. power screwdriver/nutdriver set fits  $\frac{1}{4}$ -in. or larger drills. Incl.: 2 Phillips bits (nos. 1, 2); 2 slotted bits (6-8, 8-10); Seven  $\frac{1}{4}$ -in. hex-shank nutdrivers ( $\frac{3}{16}$ ,  $\frac{1}{4}$ ,  $\frac{5}{16}$ ,  $\frac{3}{8}$ ,  $\frac{1}{2}$ ,  $\frac{5}{8}$ ,  $\frac{3}{4}$  in.); 2 double-end bits (T15, T20 (and) T25, T30); one double-end square driver bit (R1, R2) square recess insert bits—used in RV's and motor homes; one double-end slotted bit (P3, P10); 2 plastic finders and case.

9 R 25657—Wt. 9 oz. Set \$11.49

**13-pc. power screwdriver/nutdriver bit set** (not shown). Same as (25) without double-ended bits.

9 R 25653—Wt. 9 oz. . . . Set \$8.49

Magnetic holder (not shown).

Pkg. of 2.

9 R 2524—Wt. 2 oz. . . . Pkg. \$4.49

Replacement  $\frac{3}{16}$ -in. screwdriver hex bits (not shown). Pkg. of 2.

9 R 2526—Wt. 1 oz. . . . Pkg. \$2.49

Square-drive adapter (not shown).

Pkg. of 2. Wt. 1 oz.

9 R 2584 . . . Pkg. \$1.99

**26** 30-pc. power screwdriver/nutdriver bit set of alloy tool steel fits  $\frac{1}{4}$ -in. or larger electric drills. Incl: 4 Torx® bits (Nos. T-15, 20, 25, 30); 4 Phillips bits (Nos. 0, 1, 2, 3); 3 sq. dr. bits (Nos. 1, 2, 3); No. 3 clutch bit; 5 hex bits ( $\frac{3}{16}$ ,  $\frac{1}{4}$ ,  $\frac{5}{16}$ ,  $\frac{3}{8}$ ,  $\frac{1}{2}$  in.); 2 slotted bits (5-6, 8-10); seven  $\frac{1}{4}$ -in. hex-shank power nut drivers ( $\frac{3}{16}$ ,  $\frac{1}{4}$ ,  $\frac{5}{16}$ ,  $\frac{3}{8}$ ,  $\frac{1}{2}$ ,  $\frac{5}{8}$ ,  $\frac{3}{4}$  in.); 2 plastic finders,  $\frac{1}{4}$ -in. magnetic holder and case.

9 R 25654—Wt. 1 lb. 2 oz. Set \$23.99

**7-pc. power nutdriver bit set** (not shown) incl.  $\frac{1}{4}$ -in. hex-shank ( $\frac{3}{16}$ ,  $\frac{1}{4}$ ,  $\frac{5}{16}$ ,  $\frac{3}{8}$ ,  $\frac{1}{2}$ ,  $\frac{5}{8}$ ,  $\frac{3}{4}$  in.).

9 R 25655—Wt. 6 oz. . . . Set \$5.79

**7-pc. screwdriver bit set, plastic case** (not shown); 2 spade bits with finders for nos. 6-10 slotted screws; Phillips bits Nos. 1, 2, adapter for  $\frac{1}{4}$ -in. sq. dr.

9 R 2565—Wt. 5 oz. . . . Set \$4.79

Nutdriver replacement bits (not shown).

Pkg. of two. Wt. 1 oz.

9 R 25833— $\frac{3}{16}$ -in. . . . Pkg. \$1.99

9 R 25834— $\frac{1}{4}$ -in. . . . Pkg. \$1.99

9 R 25835— $\frac{5}{16}$ -in. . . . Pkg. \$2.19

9 R 25836— $\frac{3}{8}$ -in. . . . Pkg. \$2.19

9 R 25837— $\frac{1}{2}$ -in. . . . Pkg. \$2.29

9 R 25838— $\frac{5}{8}$ -in. . . . Pkg. \$2.49

9 R 25839— $\frac{3}{4}$ -in. . . . Pkg. \$2.79

Slotted screwdriver bits (not shown).

Pkg. of two. Wt. 1 oz.

9 R 2585—Small . . . Pkg. \$1.59

9 R 2587—Large . . . Pkg. \$1.59

Phillips replacement bits (not shown).

Pkg. of two. Wt. 1 oz.

9 R 2586—No. 0 size . . . Pkg. \$1.59

9 R 2581—No. 1 size . . . Pkg. \$1.49

9 R 2583—No. 2 size . . . Pkg. \$1.49

9 R 2582—No. 3 size . . . Pkg. \$1.59

Keep all 30 bits neat and organized in their Dial-a-Bit Case

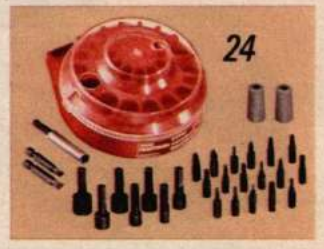

17-pc. Power Screwdriver/Nutdriver Set with case



30-pc. Power Screwdriver/Nutdriver Set with case

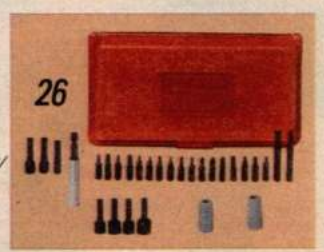

# CRAFTSMAN® drill-operated accessories



1  
Angle  
drill  
head



2  
Available in Catalog only!  
Quick bit change-out set



3  
5-pc. stop  
collar set



4  
Counter-  
sink bits



5  
Available in Catalog  
only!  
Unimixer  
attachment  
mixes  
paint,  
adhesive,  
paste,  
virtually  
any  
material

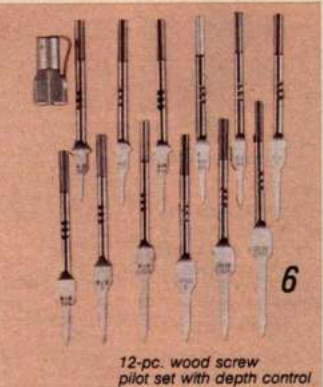

6  
12-pc. wood screw  
pilot set with depth control



7  
Brad point  
drill bits

8  
Hex  
shank  
pilot  
bits



9  
CRAFTSMAN®  
Wet Sharp  
sharpens and  
hones tools



10  
10-pc.  
extractor set



11  
Available in Catalog only!  
Our finest heavy-duty  
electric bit sharpener



12  
Electric bit  
sharpener



13  
Drill-operated  
bit sharpener

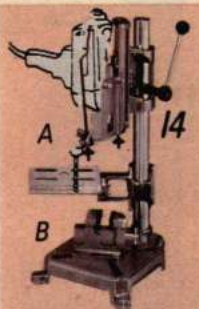

14  
Available in  
Catalog only!  
Heavy-duty  
drill stand



15  
Available in  
Catalog  
only!  
Medium-  
duty  
drill stand



16  
Drill guide (17)  
centers  
precisely  
on  
round  
stock

17  
Gives  
support  
for angle  
drilling

18  
Perfect for installing door locks



19  
Medium-  
duty  
drill  
stand



20  
Available in  
Catalog only!  
(18) drill  
guide with  
chuck

1 Angle drill head simplifies drilling in hard-to-reach places. Fits 1/4 or 3/8-in. drills. Works at 90°. 2-position handle. 1:1 ratio. 9 R 26271—Wt. 15 oz. . . \$7.99

2 Eliminates need for chuck key. Use with 1/4, 3/8-in. portable drill. Includes quick change chuck, tool holder for 1/4-round shank tools, tool holder for 1/4-in. hexagon screwdriver bits, tool holder to fit (6). 9 R 25758—Wt. 5 oz. . . Set \$9.99

3 5-piece stop collar set for drilling holes to a certain depth. Use with your drill or drill press. Fits over bit; tightens desired setting. Fits 1/4, 5/16, 3/8, 7/16, 1/2-in. bits. 9 R 67063—Wt. 3 oz. . . Set \$9.99

4 High-speed counter-sink bits of hardened tool steel let you drill metal/wood. Centerless ground 5 flutes. 82° angle. 1/4-in. shank.

Size in.	Catalog No.	Wt. oz.	Price
1/2	9 R 67161	1	\$7.49
3/8	9 R 67162	1	8.49
3/4	9 R 67163	2	8.99

5 Attaches to your 1/2-in. drill to mix at 500 to 900 rpm.

#80. 16x3-in. diameter. 9 R 25111—Wt. 12 oz. . . \$12.99

#100. 23x4-in. diameter. 9 R 25113—Wt. 1 lb. 8 oz. . . \$15.99

6 Use set to countersink, counterbore. High-carbon, heat-treated steel. Incl. sizes for Nos. 4, 5 screws (1/2, 3/8, 3/4 inch deep); Nos. 8, 9 screws (3/4, 1, 1 1/4 inches deep); Nos. 6, 7 screens (3/8, 3/4, 1-in. deep); Nos. 10, 11, 12 screws (1, 1 1/4, 1 1/2 in. deep). Incl. depth control. 9 R 4201—Wt. 8 oz. . . Set \$16.99

7 Brad point drill bits for wood have center spur that locks bits on course. 2 cutting spurs dimension around holes. Sharp flutes extend from cutting spurs, action through wood. Heat-treated alloy steel. For portable drills, drill presses with 3/8-in. or larger chuck.

Size in.	Catalog No.	Wt. oz.	Price Ea.
1/4	9 R 67053	1	\$2.99
5/16	9 R 67054	1	3.99
3/8	9 R 67055	1	4.49
7/16	9 R 67056	1	4.99
1/2	9 R 67057	1	5.99
5/8	9 R 67058	3	7.49
3/4	9 R 67059	3	8.49
7/8	9 R 67062	6	11.99
1	9 R 67061	6	13.99

5-pc. bit set, includes 1/4 thru 1/2-in. bits in (7). Sep. prices total \$22.45. 9 R 6830—Wt. 8 oz. . . Set \$19.99

8 Hex. shank pilot bits are constructed of high-speed steel.

Size, in.	Catalog No.	Wt. oz.	Price, ea.
3/32	9 R 25675	1	\$3.49
7/64	9 R 25676	1	3.49
1/8	9 R 25677	1	3.49
5/64	9 R 25678	1	3.49

4-pc. set incl. 4 bits sold separately above. 1 ea. Sep. prices total \$13.96. 9 R 25680—Wt. 6 oz. . . Set \$11.99

9 Sharpener draws water from its own reservoir to cool and clean the grinding wheel while you sharpen, hone or hollow grind! 240 grit "M" hardness honing stone. Adjustable toolrest. Meas. 7Wx6 1/2Dx 5 1/2H-in. 6-ft. cord. Knife not incl. 9 R 66995—Wt. 5 lbs. 13 oz. \$59.99

10 Simply drill hole in broken part, insert extractor, and turn to left with wrench. Part is removed without damaging threads. 10-pc. set incl. extractors (No. 1 thru 5) and 5 drill bits, 3/64, 7/64, 5/32, 1/4, 11/64 in. Case. 9 R 20616—Wt. 8 oz. . . Set \$12.99

5-pc. screw extractor set (not shown). Hand-turn, finish turning with wrench. No. 1 thru 5 sq. shanks. Case.

9 R 67372—Wt. 7 oz. . . Set \$11.99

Individual screw extractors

Sq. shank	Drill Size (in.)	Catalog Number	Price, each
For screw sizes No. 8 1/4-in. Wt. 1 oz.			
No. 1	7/64	9 R 67361	\$2.19
For screw sizes No. 12 3/16-in. Wt. 1 oz.			
No. 2	7/64	9 R 67362	\$2.29
For screw sizes 5/16-7/16-in. Wt. 1 oz.			
No. 3	5/32	9 R 67363	\$2.49
For screw sizes 7/16-9/16-in. Wt. 1 oz.			
No. 4	1/4	9 R 67364	\$2.59
For screw sizes 3/8-5/8-in. Wt. 2 oz.			
No. 5	11/64	9 R 67365	\$2.99

11 Sharpen 1/8 to 1/2-in. bits with our heavy-duty electric bit sharpener. Heavy-duty ball bearing induction-type motor provides speed of 3550 rpm. Calibrated feed control. Not for carbide-tipped bits. 11 3/4x9 1/2x8 3/8-in. 6 ft., 3-wire cord. 9 R 6684C—Wt. 18 lbs. . . \$239.99

12 Electric bit sharpener. 1/5-HP, 3000 rpm. 5 foot, 2-wire cord. 9 R 6682—Wt. 4 lbs. 4 oz. . . \$39.99

13 Drill-operated bit sharpener fits your 1/4 or 3/8-in. drill. Shpg. wt. 2 lbs. 7 oz. 9 R 6680 . . . \$19.99

14 thru 17 Craftsman drill stands and drill guide provide steady support and more control. Fit 1/4 or 3/8-inch drills except (15) does not fit 9-1148.

14 Heavy-duty drill stand for 1/2, 3/8, 1/4 in. drills (not incl.). Rack and pinion 0-2 1/2 in. depth gauge (tilt table (A) sold below). 20 in. H., 7 1/2x7 1/2 in. base. Shpg. wt. 11 lbs. 10 oz. 9 R 25989 . . . \$44.99

A Tilt table, shown with (14), fits drill stands with 1 1/2-in. diam. column. 9 R 25991—Wt. 1 lb. 9 oz. . . \$9.99

B Vise for (14-16). 4-in. base with 2-in. opening. Helps secure workpiece. Bolt not included. 9 R 2597—Wt. 1 lb. 3 oz. . . \$14.99

Drill on target . . . Craftsman hole square (not shown) helps hold up to 3/8-in. bit at 90° angle to workpiece. 9 R 2596—Wt. 1 oz. . . \$1.49

15 Medium-duty drill, sander/grinder stand with vise (B). 0-2 1/2-in. depth gauge. 18-in. high 6x6-in. base. Use vertically, horizontally. Grinding guard. 9 R 25985—Wt. 7 lbs. . . \$39.99

16 Medium-duty drill stand. 0-2 1/2-in. depth gauge. 18 in. H., 6x6-in. base. Use vertically only. 9 R 25921—Wt. 7 lbs. 2 oz. \$19.99

17 Lightweight drill guide helps drill at precise angles. Adjustable, repetitive depth control. Use vertically, horizontally. 9 R 11227—Wt. 3 lbs. 2 oz. \$19.99

18 Drill guide with chuck helps you make perfect holes when drilling at 90° to surface or up to 45° left or right. Lets you install locks, chamfer, do center drilling or doweling. Base holds round stock for center drilling. Angles marked on base in 5° increments. Angle lock knobs help provide accuracy. Guide rods. Adjustable depth control. For 1/4, 3/8 in. electric drills. Drill bit not incl. 9 R 11235—Wt. 1 lb. 8 oz. . . \$29.99 Unless indicated, drills, chucks, bits not incl. All items warranted by Sears. Write for free copy, see p. 148.

1 thru 6 Orange PVC vinyl extension cords. Year round, outdoor cord resists oil, grease, ozone. Tough and flexible, ideal for garden, outdoor tools. Meets UL standards for outdoor use.

Catalog Number	Length (feet)	Gauge no.	Max. amps at 125-v.	Watts	Shpg. wt.		Price alone	When you also buy any portable tool
					lbs.	oz.		
(1) Two-conductor for double-insulated tools. Includes handy cord lock.								
9 R 83516	25	16/2	13	1625	1	9	\$5.49	\$4.39
9 R 83517	50	16/2	13	1625	3	1	7.49	5.99
9 R 83518	100	16/2	10	1250	6	..	10.99	8.79
(2) Three-conductor, grounded.								
9 R 7797	25	16/3	13	1625	1	14	\$5.49	\$4.39
9 R 7798	50	16/3	13	1625	3	10	7.49	5.99
9 R 7799	100	16/3	10	1250	7	5	10.99	8.79
(3) Three-conductor for farm shop tools.								
9 R 5824	25	14/3	15	1875	2	11	\$8.49	\$6.79
9 R 5821	50	14/3	15	1875	5	..	9.49	7.59
9 R 83508	100	14/3	13	1625	9	9	18.99	15.19
(4) Three-conductor with power block allows you to plug 3 tools in 1 outlet.								
9 R 83566	25	14/3	15	1875	2	1	\$11.99	\$9.59
9 R 83567	50	14/3	15	1875	5	..	18.99	15.19
9 R 83568	100	14/3	10	1625	9	1	27.99	22.39
(5) Three-conductor, grounded.								
9 R 83571	25	12/3	15	1875	3	14	\$13.99	\$11.19
9 R 83572	50	12/3	15	1875	7	8	22.99	18.39
9 R 83573C	100	12/3	15	1875	15	..	43.99	35.19
(6) Three-conductor with power block allows you to plug 3 tools in 1 outlet.								
9 R 83576	25	12/3	15	1875	4	..	\$15.99	\$12.79
9 R 83577	50	12/3	15	1875	7	5	25.99	20.79
9 R 83578	100	12/3	15	1875	14	..	46.99	37.59

7 Black rubber extension cords are lightweight, durable TPE rubber. Weather-resistant, stay flexible as low as -40°F. Resist most chemicals and solvents. Three-conductor for grounding. Meet UL standards for outdoor use.

Catalog Number	Length (feet)	Gauge no.	Max. amps at 125-v.	Watts	Shpg. wt.		Price alone	When you also buy any portable tool
					lbs.	oz.		
9 R 83581	25	16/3	13	1625	1	8	\$9.49	\$7.59
9 R 83582	50	16/3	13	1625	3	..	15.99	12.79
9 R 83583	100	16/3	10	1250	5	8	25.99	20.79

8 and 9 Premium quality, long life TUF-FLEX® TPE rubber extension cords. These all-weather cords combine the best qualities of neoprene, vinyl and rubber. Lighter weight than vinyl cords and outstanding in resistance to abrasion, ozone, ultraviolet deterioration, oxygen and most chemicals. Ideal for extreme temperatures... stays flexible up to 221°F and low as -58°F. Meet UL standards for outdoor use.

Catalog Number	Length (feet)	Gauge no.	Max. amps at 125-v.	Watts	Shpg. wt.		Price alone	When you also buy any portable tool
					lbs.	oz.		
(8) Three-conductor, grounded.								
9 R 83591	25	16/3	13	1625	1	8	\$7.49	\$5.99
9 R 83592	50	16/3	13	1625	2	12	11.99	9.59
9 R 83593	100	16/3	10	1250	5	8	22.99	18.39
(9) Three-conductor with power block allows you to plug 3 tools in 1 outlet.								
9 R 83596	25	14/3	15	1875	2	..	\$12.99	\$10.39
9 R 83597	50	14/3	15	1875	4	5	20.99	16.79
9 R 83598	100	14/3	13	1625	8	10	42.99	34.39

These "ergonomically" designed tools give you the same reliability and performance as our traditional 1/4-HP non-modular tools with less bulk and easier handling, making them ideal for "job site" use. Motor pack slides in and locks into place. No special tools needed. Individual modules govern motor speed and reversibility for peak efficiency and proper functioning. All tools use standard accessories. (10 thru 14) Warranted by Sears, write for free copy, see p. 148.

10 Orbital-motion pad sander module has no-load speed of 11,000 orbits per min. for fine finishing. Flush sands on all four sides. Takes 1/4-sheet adhesive-backed or standard sandpaper. Permanently lubricated ball, sleeve bearings. On/off switch. Requires motor pack (13) sold below. 9 R 14604—Shpg. wt. 2 lbs. 3 oz. . . \$19.49

11 Drill module has trigger-activated speed control which generates no-load speeds of 0-1200 rpm. Slide-type reversing lever, 3/8-in. chuck. Center handle for easier control, perfect balance. Chuck key stores within the handle. Permanently lubricated ball, sleeve bearings. Requires motor pack (13) below. 9 R 14602—Shpg. wt. 1 lb. 10 oz. . . \$19.49

12 Sabre saw module has no-load variable speeds of 0 to 3000 strokes per minute. Compact design gives you precision control with less fatigue. Base tilts up to 45° left or right for bevel cuts. Uses standard shank sabre saw blades. Has permanently lubricated sleeve bearings. Requires motor pack (13) below. 9 R 14606—Shpg. wt. 1 lb. 9 oz. . . \$19.49

13 Motor pack operates all tool modules above with the same power and reliable performance as any of our 1/4-HP power tools. Perm. lubricated ball bearings for smooth, quiet operation. 6-ft. cord. 9 R 14600—Shpg. wt. 1 lb. 12 oz. . . \$19.49

14 Soft pouch tool carrier holds tools, motor and accessories for convenient transportation and storage. Has 6 outside pockets, large interior with 3 snap-out dividers. 13 1/2 x 6 x 10 1/2-in. 9 R 14608—Shpg. wt. 1 lb. 8 oz. . . \$19.49

Save \$12.46 when you buy all 3 tool modules, motor pack and tool pouch. Separate prices total \$97.45. 9 R 14610—Shpg. wt. 7 lbs. 6 oz. . . \$84.99

## A revolutionary idea in consumer portable electric tools... CRAFTSMAN® Modular Tool System

- ✓ 3 different tools with a single power source
- ✓ Delivers the same quality performance found in our traditional 1/4-HP tools
- ✓ Lightweight... requires less storage space. Optional pouch for portability
- ✓ An outstanding value priced to fit any budget



Pad Sander Module



Variable-speed, reversible 3/8-inch Drill Module



Variable-speed Sabre Saw Module



1/4-HP Motor Pack



Soft pouch Tool Carrier

Only \$19.49 Per component

Save \$12 when you buy them all! Motor Pack, Tool Modules and Tool Pouch

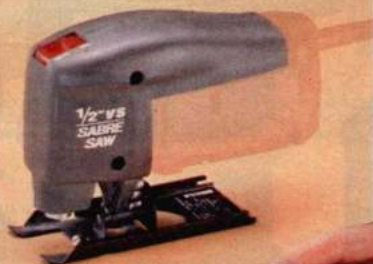

Precision alignment for fast connection without additional tools... motor slides in and locks into place

Buying the proper extension cord is as important as buying the right tool. Always select the correct cord to protect your tools and equipment. Find the correct cord by simply matching your tool's amp rating to the cord amp rating. Then choose from our 3 cord families—PVC vinyl cords, black TPE rubber cords, TUF-FLEX® rubber cords—according to your individual needs.

**Save 20%** on an extension cord when you also buy any portable electric tool in this Catalog!



Rating of tool or appliance			Recommended wire gauge (AWG)	
Amps	Watts	Capacity	Up to 50 ft. long	Up to 100 ft. long
10	1250	Regular-duty	18 AWG	16 AWG
13	1625	Heavy-duty	16 AWG	14 AWG
15	1875	Extra heavy-duty	14 AWG/12 AWG	12 AWG

This table shows the recommended wire gauge and length for various amps and watts at 125 volts

- SearsCharge and Discover Card... each is different, but together they're all you really need
- To apply for SearsCharge only  
CALL TOLL FREE 1-800-323-3274  
IN ILLINOIS CALL 1-800-942-7446

ONE QUALITY NAME

**CRAFTSMAN**

OFFERS MORE GOOD CHOICES

What they can do will amaze you. Properly accessorized, our routers perform decorative carving, edging, signing, turning, jointing, copying and more. Once you decide how you want to use the tool, you'll discover what many others have . . . we offer the CRAFTSMAN® router that will suit your needs

Here's why our 1½-HP router is one of America's Best Sellers . . .

- ✓ Generates maximum no-load speed of 25,000 rpm for clean cuts in hardest woods
- ✓ Ring-type depth adjustment gauge with 1/64-inch graduations
- ✓ Smooth gliding polymer sub-base won't scratch or mar workpiece
- ✓ Large, contour grip handles for easy maneuvering
- ✓ Shaft lock prevents accidental starts, frees hand for quick, easy bit changes

**\$67<sup>99</sup>**



5/8-HP light-duty router  
**\$27<sup>99</sup>**



1-HP medium-duty router  
**\$47<sup>99</sup>**



1¼-HP heavy-duty router  
**\$54<sup>99</sup>**



**1 thru 4** Our routers have new lower everyday prices! Maximum no-load speed of 25,000 rpm. Cuts 0 to 1½ in. deep. Uses ¼-in. shank bits; wrench incl. Shaft lock. Warranted.\*

**1** Single chip deflector. Slide-type switch. Ball, sleeve bearings. 9 R 1730—Wt. 4 lbs. 8 oz. . . \$27.99

**2** Router has zero reset depth adjustment, single chip deflector, slide-type on/off switch. Ball bearings. 9 R 17445—Wt. 7 lbs. . . \$47.99

**3** Worklight for clear view surface. Zero reset depth adjustment. Single chip deflector. Locking trigger switch. Ball bearings. 9 R 1756—Wt. 8 lbs. 13 oz. . . \$54.99

**A** Save 25% on case when you also buy router. Permanex® polyethylene. 12Lx10Wx7-in. deep. Shpg. wt. 2 lbs. 1 oz. 9 R 14701 . . . Alone \$18.99  
When you also buy router. . . case \$14.24

**4** 1½-HP router has every feature listed in (3) and you can clean while you work with dust pick-up system and two chip deflectors. 9 R 1743—Wt. 9 lbs. 12 oz. . . \$67.99

Same as (4) without dust pick-up, chip deflectors. 9 R 1749—Wt. 9 lbs. . . \$57.99

**5 thru 8** Ridged tops prevent sawdust build-up. Adjustable fences incl. Fits CRAFTSMAN routers (except 9-1730), others with 6-in. base. Clamp, router, bits not incl. Unassembled.

**5** Structural foam fences. Hinged guard. 13¼x18x11 in. high. 9 R 25473—Wt. 8 lbs. 6 oz. . . \$24.99

**6** Structural foam fences. Hinged guard. 13¼x18x11 in. high. 9 R 25475—Wt. 8 lbs. 2 oz. . . \$37.99

**7** Transparent hinged guard. Wood, aluminum fences. Incl. miter gauge. 13¼x18x11-in. high. 9 R 25444—Wt. 11 lbs. 2 oz. . . \$47.99

**8** Our finest router table with exclusive fence design. Retractable guard and pocket fence "disappear" for regular routing, repositions for jointing. Interlocking carriage secures workpiece vertically during special operations. Dust collection system works with your vac. Die-cast aluminum top with reinforced ribs; steel legs. 13¼x18x15½ in. H. 9 R 25479—Wt. 13 lbs. . . \$67.99

**B** Our fence/sawdust collector system alone. Fits most CRAFTSMAN router tables. 11¼x18x5¼ inches high. 9 R 25209—Wt. 4 lbs. 10 oz. . . \$19.99  
\*Warranted by Sears. Write for free copy, see p. 148. Tools are double-insulated. . . need no grounding. Have 6-foot, 2-wire cord.

**9** Cord set/switch mounts on most Craftsman router tables. Insert router plug into switch receptacle . . . now you have on/off switch with key lock. Includes hardware and key. 6-foot 3-wire cord. 9 R 25182—Wt. 1 lb. 8 oz. . . \$19.99

**10** Package of 2 extensions for (5-7) provide over 200 square inches space. Stamped steel with painted finish. 13¾Lx8Wx1¼H inches. ¾x¾-inch miter slot. 9 R 25211—Wt. 4 lbs. 11 oz. . . \$9.99

**11** Miter gauge allows you to guide workpiece 0°-45° right or left, with its graduated protractor, for exact angle cut. ¾Wx¾D inch bar. Accepts hold-down clamp. 9 R 25213—Wt. 8 oz. . . \$4.99

**12** Hold-down clamp secures stock. Attaches to miter gauges. 9 R 29504—Wt. 6 oz. . . \$5.99



Available in Catalog only!  
Router Table with structural foam top and legs **\$24<sup>99</sup>**



Router Table with aluminum top and structural foam legs **\$37<sup>99</sup>**



Router Table with die-cast aluminum top and steel legs **\$47<sup>99</sup>**



Our finest CRAFTSMAN Router Table was far ahead of the competition when it was introduced. It's still leading all the rest! Here's why . . .



Exclusive unitized fence design and built-in sawdust collection system



Transparent retractable guard and built-in pocket fence



Exclusive interlocking carriage for special routing operations

**\$67<sup>99</sup>**

- ✓ Hinged guard covers moving bit and allows you to see what you carve
  - ✓ Miter gauge included for accurate angle cuts
- Available in Catalog only!



Cord Set/switch for CRAFTSMAN router tables



Extension Tables increase workspace



CRAFTSMAN Miter Gauge



Hold-down Clamp

You know they're good because they're CRAFTSMAN, but did you know our router bits outlast and out-perform ordinary router bits by an incredible 5 to 15 times!

These bits are our finest CRAFTSMAN professional production-quality bits. Here's why...

- ✓ Thicker carbide tips than even our bits below, making these by far our most durable, longest lasting bits!
- ✓ Two-flute, high-shear angle design produces smoothest, sharpest cut possible
- ✓ Tough alloy steel body for years of continuous service

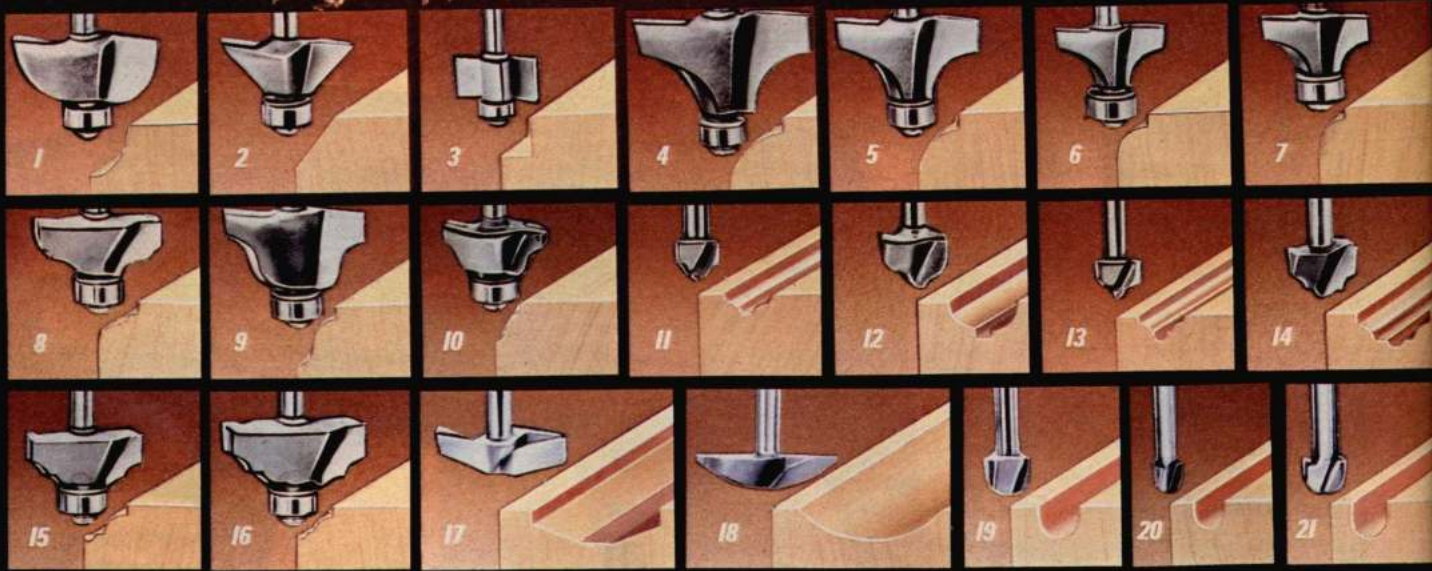

These CRAFTSMAN Carbide-tipped bits last an incredible 15 times longer than the bits on the opposite page!

Bits (22 thru 30) require arbor set (43)

Bits (31 thru 42) have 1/4-inch steel shanks

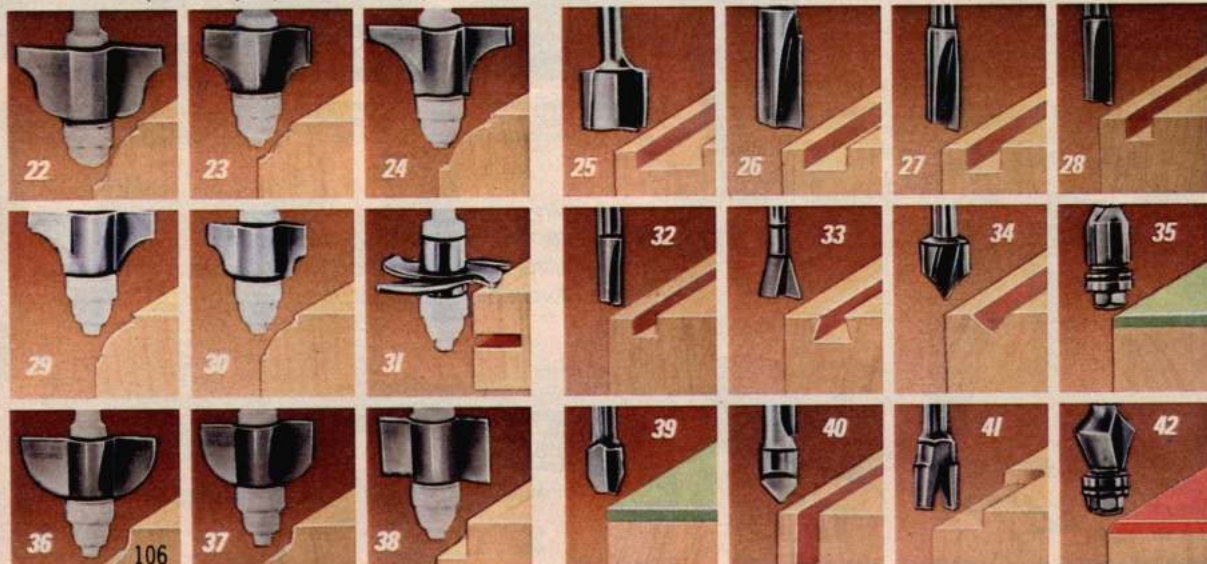

CRAFTSMAN Edging Bit Arbor Sets save money in two ways ... act as shank for multiple edging bits and 2 pilots let you make 2 different cuts with a single bit!



# These CRAFTSMAN® Kromedge Bits retain their sharpness up-to 5-times longer than ordinary bits!

1 thru 21 Our finest CRAFTSMAN carbide-tipped bits are the most durable, longest-lasting bits we sell. Tough alloy steel body. Integral 1/4-inch diameter steel shank. Edging bits (1 thru 10, 15, 16) have ball-bearing pilot for smooth cuts.

Bit	Description	Size in.	Catalog Number	Wt. oz.	Each
(1)	Cove	1/2	9 R 25554	1	\$24.99
(2)	45° Chamfering	5/8	9 R 25464	1	23.99
(3)	Rabbet	5/16	9 R 25556	1	22.99
(4)	Corner round	5/8	9 R 25536	2	24.99
(5)	Corner round	1/2	9 R 25538	1	23.99
(6)	Corner round	3/8	9 R 25555	1	22.99
(7)	Corner round	5/16	9 R 25537	1	21.99
(8)	Ogee w/Fillet	1 3/8	9 R 25534	1	29.99
(9)	Roman Ogee	1/4	9 R 25535	1	27.99
(10)	Roman Ogee	3/32	9 R 25557	1	29.99
(11)	Ogee	1/2	9 R 25584	1	13.29
(12)	Ogee end-cutting	3/4	9 R 25825	1	14.99
(13)	Classic	1/2	9 R 25595	1	12.99
(14)	Classic	3/4	9 R 25463	1	14.99
(15)	Classic	1 1/4	9 R 25532	1	28.99
(16)	Classic	1 1/2	9 R 25533	1	29.99
(17)	Panel-raising		9 R 25465	1	21.99
(18)	Radius end-cove	1	9 R 25526	1	19.99
(19)	Core Box	1/2	9 R 25546	1	12.99
(20)	Core Box	3/4	9 R 25547	1	11.99
(21)	Core Box	1	9 R 25829	1	14.99

3/8-in. diameter Ball-bearing Pilot (not shown) converts (4 thru 7) into beading bits. Steel. 9 R 25553—Shpg. wt. 1 oz. . \$4.99

Carbide-tipped bit sets. All except 3-piece set includes bit case (88), and arbor set (43).

3-pc. set includes bits (35, 40, 42). Separate prices total \$24.47.

9 R 22114—Shpg. wt. 4 oz. . \$19.99

14-pc. set incl. bits (22, 26-30, 34, 35, 37, 38, 40, 41). Sep. prices total \$131.16.

9 R 22121—Shpg. wt. 1 lb. 4 oz. . \$99.99

25-pc. set incl. bits (11 thru 13, 21 thru 30, 33 thru 38, 40 thru 42). Sep. prices total \$260.75.

9 R 22119—Shpg. wt. 1 lb. 12 oz. . \$199.99

22 thru 42 Individual CRAFTSMAN Carbide-tipped bits use a silver alloy to braze carbide tips to their alloy-steel bit bodies. This process lets them last 15 times longer than Kromedge bits at right. Shpg. wt. 1 oz.

Bit	Description	Size in.	Catalog Number	Price
(22)	Roman Ogee	1/4	9 R 25504	\$12.29
(23)	Roman Ogee	3/32	9 R 25507	13.29
(24)	Bead: Quarter-round	1/2	9 R 25565	12.69
(25)	Straight-face, 2-fluted	3/4	9 R 25506	11.99
(26)	Straight-face, 2-fluted	1/2	9 R 25827	10.49
(27)	Straight-face, 2-fluted	3/8	9 R 25826	9.49
(28)	Straight-face	3/16	9 R 25525	5.79
(29)	Bead: Quarter-round	3/8	9 R 25566	12.49
(30)	Bead: Quarter-round	1/4	9 R 25503	12.99
(31)	Slotting Cutter Set*		9 R 25898	22.99
(32)	Straight-face	1/4	9 R 25524	5.29
(33)	Dovetail Cutter	1/2	9 R 25505	7.29
(34)	V-groove Chamfer	1/2	9 R 25578	8.49
(35)	Str. Veneer Trimmer	1/2	9 R 25413	9.49
(36)	Cove	1/2	9 R 25575	13.29
(37)	Cove	3/8	9 R 25576	12.29
(38)	Rabbett		9 R 25582	12.49
(39)	Comb. Formica Cutter	3/16	9 R 2541	5.29
(40)	Comb. Panel Cutter	3/8	9 R 25541	5.49
(41)	Butt-hinge Mortising	1/2	9 R 25551	6.69
(42)	22° Bevel	1/2	9 R 25412	9.49

\*Cuts 3/8-5/8-in. rabbets. †Incl. 1/2-in. kerf, 2-wing slotting cutter. 3/8-in. 2-wing slotting cutter. 2 steel spacer bushings.

1/2-in. replacement ball bearing and slinger for arbor set (43) and bits (35, 42). 9 R 25411—Shpg. wt. 1 oz. . \$2.49

**43 CRAFTSMAN Arbor Set** for use with all carbide-tipped edging bits (22-24, 29-31, 36-38) includes 1/4-in. interchangeable steel arbor, 3/8 and 1/2-in. ball-bearing pilots for easy cuts, slinger, nut and bearing adapter. Bits not incl. 9 R 25895—Shpg. wt. 3 oz. . Set \$6.69

**44 Use this CRAFTSMAN Arbor Set** with any Kromedge edging bit (46 thru 56). Set incl. 1/4-in. interchangeable steel arbor, 3/8-in. ball-bearing pilot for easy cuts. 3/8-in. solid-type pilot and nut. Bits not incl. 9 R 25601—Shpg. wt. 6 oz. . Set \$4.69

**45 Use this CRAFTSMAN Arbor Set** with any Kromedge edging bit (46 thru 56). Set incl. 1/4-in. interchangeable steel arbor, 3/8 and 1/2-in. solid-type pilots. Bits not incl. 9 R 2589—Shpg. wt. 1 oz. . Set \$3.49

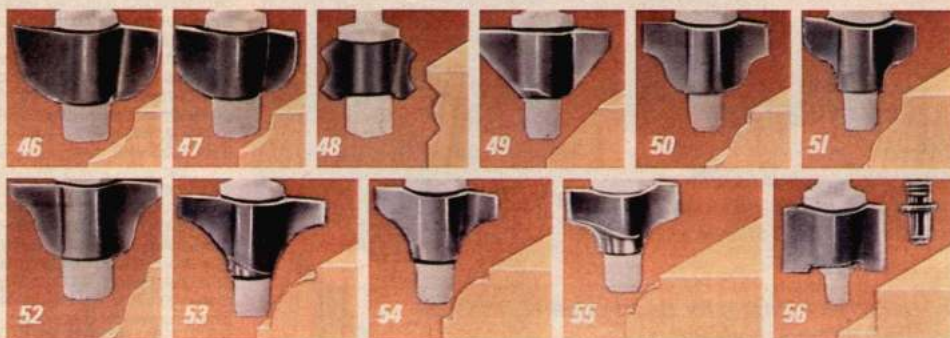

Bits (46 thru 56) need arbor set (44 or 45)

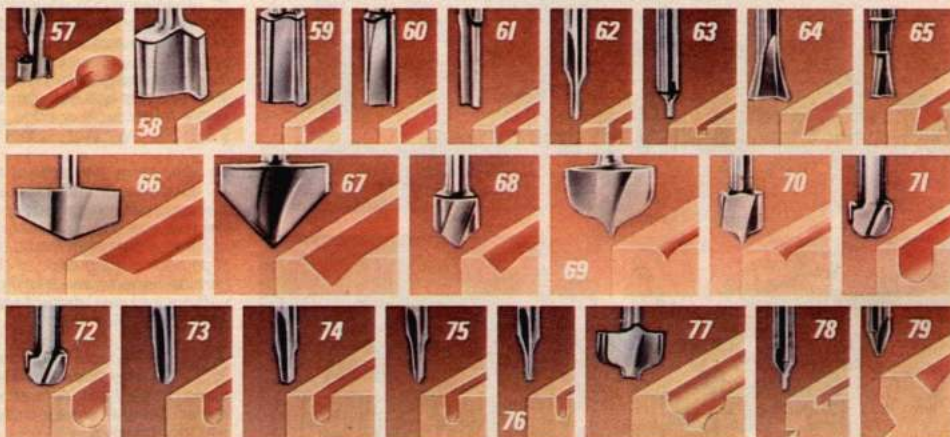

Case holds 26 bits (not incl.)

This 44-pc. capacity Bit Case is included with the 14-pc. and 25-pc. carbide-tipped bit sets

Help your router give the best finish cuts using the CRAFTSMAN Router Bit Sharpening Kit

**46 thru 86 CRAFTSMAN Kromedge bits** of high-speed steel are precision-ground and fortified with chrome-plated steel.

Bit	Description	Size in.	Catalog No.	Wt. oz.	Price	Bit	Description	Size in.	Catalog No.	Wt. oz.	Price
(46)	Cove	1/2	9 R 25571	1	\$5.49	(67)	V-groove Chamfering	3/8	9 R 25579	1	\$6.69
(47)	Cove	3/8	9 R 25572	3	5.29	(68)	V-groove Chamfering	1/2	9 R 2557	1	5.49
(48)	Radius edge bead	1/4	9 R 25527	1	5.99	(69)	Pl-cutting Ogee	3/32	9 R 25583	1	7.49
(49)	45° Chamfering		9 R 25589	1	5.49	(70)	Point Cut Ctr-round	3/16	9 R 25567	1	4.99
(50)	Roman Ogee	3/32	9 R 25587	1	6.19	(71)	Core Box	1/4	9 R 25591	1	3.99
(51)	Ogee	3/16	9 R 25585	1	5.99	(72)	Core Box	1/2	9 R 25596	3	4.29
(52)	Roman Ogee	1/4	9 R 25588	1	7.19	(73)	Veining	1/4	9 R 25594	1	3.29
(53)	Bead: Quarter-round	1/2	9 R 25561	1	5.99	(74)	Veining	3/8	9 R 25593	1	3.09
(54)	Bead: Quarter-round	3/4	9 R 25562	1	5.49	(75)	Veining	1/2	9 R 25592	1	2.89
(55)	Bead: Quarter-round	1/4	9 R 25563	1	4.99	(76)	Veining	3/4	9 R 2559	1	2.69
(56)	Rabbet with pilot		9 R 25581	1	6.49	(77)	Ogee End-cutting	3/4	9 R 25598	1	6.99
(57)	Key Slot Cutter	3/8	9 R 25548	1	4.99	(78)	Double end straight/Vein	1/8	9 R 25599	1	4.59
(58)	Straight-face	1/2	9 R 25529	1	5.99	(79)	Double end 45°, 60° V-groove		9 R 25545	1	3.99
(59)	Straight-face	3/4	9 R 25523	3	3.89	(80)	Dovetail Cutter	3/32	9 R 25539	1	5.49
(60)	Straight-face	1/4	9 R 25521	1	2.99	(81)	Comb. Panel Cutter	1/4	9 R 2554	1	2.69
(61)	Straight-face	3/8	9 R 25522	1	2.29	(82)	Butt-hinge Mortise**	1/2	9 R 2555	3	4.49
(62)	Straight-face	1/2	9 R 2552	3	2.09	(83)	Edge-rounding		9 R 25586	5	4.59
(63)	Straight-face	3/8	9 R 25528	1	1.89	(84)	Double-bead Edging		9 R 25597	1	4.59
(64)	Dovetail Cutter	1/2	9 R 25531	1	5.99	(85)	X-long Carving		9 R 2569	1	2.99
(65)	Dovetail Cutter	3/4	9 R 2553	1	4.89	(86)	Straight-face	3/8	9 R 25520	1	2.19
(66)	Panel-raising		9 R 25568	1	6.69						

\*Cuts 1/4, 5/16, 3/8-in. rabbets, 1/8-in. surface cuts. \*\*Can use with Dovetail Joint Fixtures, p. 108.

\*\*Can use with Butt-hinge Templates, p. 108. †Can use with Dovetail Template, p. 108.

9-pc. Kromedge bit set incl. bits (47, 54, 60, 62, 68, 75) arbor set (45). Separate prices total \$27.73.

Shpg. wt. 5 oz. 9 R 21213... Set \$19.99

18-pc. Kromedge bit set incl. bits (47, 50, 54 thru 56, 59 thru 62, 68, 73, 75, 79), arbor set (45) and bit case (88). Sep. prices total \$64.85.

Shpg. wt. 1 lb. 14 oz. 9 R 21217... Set \$49.99

40-piece Kromedge Bit Set includes bits (39, 46, 47, 49 thru 56, 58 thru 70, 72 thru 76, 79, 81, 84) plus two arbor sets (45) and bit case (88). Separate prices total \$165.65. Shpg. wt. 2 lbs. 9 R 21221... Set \$119.99

**A CRAFTSMAN Router Bit Sharpening Kit** can be used on most bits with 1/4-in. diameter shank... simply attach to your router (not incl.). Fits all Sears routers except 9-1735. Wt. 1 lb. 10 oz. 9 R 66501... Kit \$27.99

**87 Large router bit case** holds up to 26 bits 5/4x5 1/2x3/8 in. deep. 9 R 25005—Shpg. wt. 4 oz. . \$3.99  
Small router bit case (not shown) holds up to 16 bits. 5 1/2x3 1/2x3/8 in. deep. 9 R 25010—Shpg. wt. 3 oz. . \$2.99

**88 Router bit case** holds up to 44 bits (not incl.). 6 1/2x3 1/2 in. high. Shpg. wt. 12 oz. 9 R 2558... \$5.99

# CRAFTSMAN® Router Accessories take those projects off your mind and into reality



Create interlocking joints like those in fine cabinetry and furniture with this Rail and Stile Router Bit Set

**1** 5-pc. carbide-tipped rail and stile cutter bit set. Create your own cabinet doors, paneled walls, wainscoting and the most professional-looking interlocking joint... like those found in fine factory furniture. Set includes 2-pc. carbide-tipped rail and stile cutter set; arbor, bushing and guide bearing. Use with CRAFTSMAN router tables.  
9 R 21257—Wt. 2 oz. . . Kit \$29.99



Make crown molding for decorative treatments on furniture and more using our Crown Molding Router Bit Set

**2** 7-pc. crown molding bit set makes various shapes of crown molding for use on furniture, panels. Kit incl.: V-groove bit, 1/2-in. carbide tipped cove box bit, 1-in. end cove bit; 1/4-in. bead and chamfer bit; arbor, pilot set, case. Use with CRAFTSMAN router tables. Shipping weight 5 ounces.  
9 R 21255 . . . Kit \$39.99



5-pc. Tongue and Groove Router Bit Set

**3** 5-piece tongue and groove bit set enables you to adjust the "fit" of the tongue and the groove producing exact fit you want. Incl. two carbide-tipped 1/4-in. groove cutting bits; hardened and ground precision arbor; steel spacers and nut. Can be used with a router table or edge guide.  
9 R 21260—Wt. 2 oz. . . \$29.99

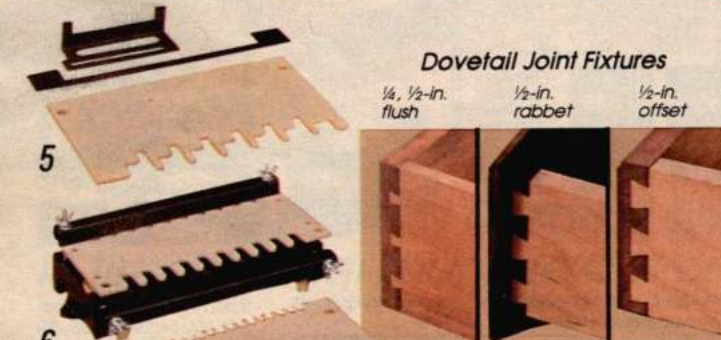

Dovetail Joint Fixtures

1/4, 1/2-in. flush      1/2-in. rabbet      1/2-in. offset

**4** One-piece drawer joint and box joint bit is all that is required to cut a beaded dado joint when constructing drawers and boxes. Quickly and accurately cuts both the front and side. High hook cutting edge of durable carbide-tipped steel does the end grain cutting. Includes instructions. Wt. 1 oz.  
9 R 21262 . . . \$21.99

**5 thru 7** Perfectly align drawer fronts and sides from 7/16 to 1 1/16 in. using dovetail joint fixtures with your router. Channel plate, combs and clamps included.

**5** Only at Sears! "Hand cut"-style dovetail template. Old style dovetails are spaced apart and equally centered on all drawers up to 8 inches deep. For use with fixture (6) only. Requires bit (80) sold on page 107.  
9 R 25702—Wt. 14 oz. . . \$12.99

**6** For drawers up to 8 inches deep. Make 1/2 and 3/4-inch flush, 1/2-inch offset and rabbeted dovetail joints. Requires bits (64 and 65) sold on page 107. Includes guide bushings.  
9 R 2570—Wt. 3 lbs. 2 oz. . . \$27.99

**7** For drawers up to 12 in. deep. Makes 1/2, 3/4-in. flush, offset and rabbeted dovetail joints. Requires bit (64) sold on p. 107. Includes template for 1/4, 1/2-in. joints.  
9 R 2579—Wt. 5 lbs. 8 oz. . . \$39.99

Box Joint Templates for use with (7) above to make box joints.  
9 R 2580—Wt. 12 oz. . . \$15.99

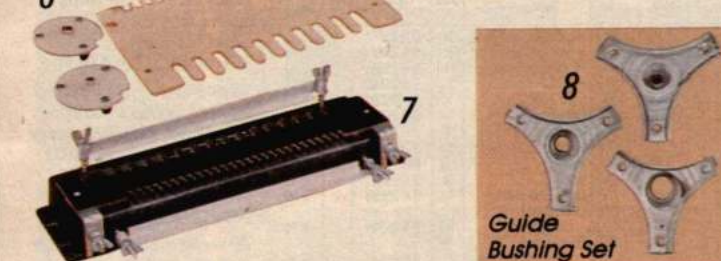

Guide Bushing Set

**8** Guide Bushing Set guides bit as it moves over template. Use with (5) above. Steel plate has sleeve for bit. Incl. 3/16, 7/16, 9/16-in. diam. bushings.  
9 R 25082—Wt. 10 oz. . . Set \$7.49

**9** Craftsman multi-purpose router guide sets up easily... simply replace router sub-base with detachable portion of guide. Fits all Sears routers (except 9-1735). Router, bit not included. Wt. 1 lb. 8 oz.  
9 R 25179 . . . \$14.49

Router base (not shown) improves visibility for freehand and lettering work. 4-in. diameter hole. Plastic non-mar surface. Fits Sears routers (not incl.) except 9-1735.  
9 R 25086—Wt. 2 oz. . . \$2.49

**10** Make square or rounded hinges up to 5-in. long on 2 or 3-hinge doors. Incl. 3 template clamps; 3 1/2, 4-in. butt-hinge templates. Steel bars, aluminum templates. Req. guide bushings (8).  
9 R 2564C—Wt. 9 lbs. . . \$58.99

**11** Butt-hinge templates alone. Includes one 3 1/2-in. and one 4-in. long template. Requires guide bushings (8).  
9 R 2575—Wt. 11 oz. . . \$5.79

5-piece Kromedge steel edgeworker bit set with 1/4-in. diam. shanks. Includes 1/2-in. core box; 1/4-in. veining; 1/2-in. ogee end-cutter; 1/2-in. edge-rounding; 1/2-in. double-bead edging; plastic case. Separate prices total \$23.75 on page 107. Wt. 5 oz.  
9 R 21214 . . . Set \$16.99

11-piece router bit set is perfect for decorative edging. Kromedge steel bits have 1/4-in. diam. shanks. Incl. 3/8-in. cove bit; rabbet bit with pilot for 1/4, 5/16 and 3/8-in. rabbet cuts and 1/8-in. surface cut; 3/16-in. ogee bits; 1/4-in. Roman ogee bit; 3/8-in., 1/4-in. bead and quarter-round bits; 1/4-in. interchangeable arbor with 7/16-in., 5/16-in. solid-type pilots; case. Separate prices total \$44.92, p. 107. Shpg. wt. 1 lb. 6 oz.  
9 R 25422 . . . Set \$29.99

Bowl-crafter bits of Kromedge high-speed steel.  
9 R 21237—Outside-convex  
9 R 21238—Inside-concave  
9 R 21236—Straight turning  
Shpg. wt. 1 oz. . . Each \$4.99

3-pc. set of bowl-crafter bits. Sep. prices total \$14.97.  
9 R 21235—Wt. 3 oz. . . Set \$12.99

Drive Adapter for router-crafter allows cuts over full length of workpiece. Includes spindle and removable drive center for locating workpiece (interchanges with original spindle).  
9 R 25256—Wt. 12 oz. . . \$10.99

11-pc. router-crafter Kromedge bit set of high-speed steel has 1/4-in. diam. shanks. Incl. rabbet bit with pilot for 1/4, 5/16, 3/8-in. rabbet cuts and 1/8-in. surface cut; panel-raising bit; 3/8-in. V-groove chamfering bit; 5/16-in. point-cutting ogee bit; 3/16-in. point-cutting quarter-round bit; 1/2-in. core box bit; 1/4 in. veining bit; 1/4-in. interchangeable arbor with 7/16, 5/16-in. solid-type pilots. Sep. prices total \$43.42 on p. 107.  
9 R 21227—Wt. 8 oz. . . Set \$34.99

Make accurate edging, contour, even full 24-inch diameter circle cuts plus trim or bevel laminate using a single accessory... the CRAFTSMAN Multi-purpose Router Guide



Template Clamps let you quickly and accurately mortise doors, jambs and more



**12 Router-Recreator\*** lets you make 3-dimensional figures up to 8x8 in. tall, signs, edge plaques, spindles. Steel yoke assembly and pulleys, plastic pulley-guard covers. Two 4x4 in. particleboard mounting blocks, shelf supports. 2 stylus rods with 3 tips ( $\frac{1}{16}$ ,  $\frac{1}{8}$ ,  $\frac{1}{4}$  in.).  $\frac{3}{4}$  in. sleeve, hardware, instr. incl. 27 $\frac{1}{2}$ x23 $\frac{1}{4}$  in. wide. Fits routers with 3 to 3 $\frac{1}{4}$ -in. diam. motor body. 9 R 25189C—Wt. 38 lbs. . . \$119.99

**13 5-pc. bit set (for 12).** Kromedge steel with  $\frac{1}{4}$ -in. diam. shanks. Incl.:  $\frac{3}{4}$ ,  $\frac{1}{4}$ ,  $\frac{1}{8}$  in. straight face; double-end 45/60 V-groove; x-long carving bit. 9 R 21216—Wt. 4 oz. . . Set \$14.99

Save when you buy (12) with bit set (13). Separate prices total \$134.98. Shpg. wt. 38 lbs. 9 R 25009C . . . Set \$107.98

**14 Incl. extruded aluminum guide rails; 8 clamps, 7 corner templates; 3 rail and stile templates; one set of blank corners to attach your own design.** Requires  $\frac{3}{8}$ -in. guide bushings sold on page 108. Fits  $\frac{1}{2}$ -HP or larger router. Wt. 8 lbs. 8 oz. 9 R 25469C . . . \$79.99

**3-pc.  $\frac{1}{2}$ -in. decorating bit set of high-speed steel with carbide tips has  $\frac{1}{4}$ -in. diam. shanks. Incl. ogee, classic and V-groove chamfering bit.** 9 R 22115—Wt. 3 oz. . . Set \$27.99

**$\frac{1}{2}$ -inch ogee bit (not shown)** 9 R 25584—Wt. 1 oz. . . \$13.29

**$\frac{1}{2}$ -inch classic bit (not shown)** 9 R 25595—Wt. 1 oz. . . \$12.99

**15 Router pantograph\*** carves 3-dimensional figures plus 2-dimensional drawings. Also makes forms, line drawings, letters and numbers. 40°, 50°, 60° reductions. Letters, numbers 3 $\frac{1}{2}$ , 4 $\frac{1}{2}$ , 5 $\frac{1}{2}$  in. high. Upper and lower case letter styles incl.: Old English, Oriental, Script, Modern and Computer (upper case only). Instr. Fits Sears routers, others with 6-in. diam. base. Router, patterns not incl. 9 R 25187C—Wt. 7 lbs. 8 oz. . . \$32.99

**16 2-dimensional router pantograph\*** is similar to (15). Makes line drawings; modern-style upper and lower case letters, numerals in 42°, 50°, 58° size reductions. Fits Sears routers, others with 6-in. diam. base. Plastic base, 6 $\frac{1}{2}$ x10x $\frac{1}{8}$ -in. diameter. Shpg. wt. 3 lbs. 11 oz. 9 R 25183C . . . \$15.99

Replacement stencil set has upper, lower case letter styles: Old English, Oriental, Script, Modern, (Computer upper case only). For (15 and 16). 9 R 2518—Wt. 1 lb. 13 oz. . . \$9.99

**17 Rout-A-Signer** makes letters and numbers from  $\frac{3}{4}$  to 4 $\frac{1}{2}$  in. high. Accepts boards 2 to 10 in. wide,  $\frac{1}{2}$  to 2 in. thick, any length. Incl. router adapter, letter frame, steel bars, 26 upper-case letters and 10 numerals in 1 $\frac{1}{2}$  and 2 $\frac{1}{2}$ -in. heights. Letters and numbers slant to right. Carousel holds templates for easy storage. Instr. incl. 30x22x2 $\frac{1}{2}$ -in. high. Fits Sears and other routers with 6-in. diam. or smaller base. Router, bit not incl. Order bit set (18), right. Partially assembled. 9 R 2572C—Wt. 10 lbs. 4 oz. . . \$37.99

**18 7-piece Rout-A-Signer Kromedge bit set** of hi-speed steel has  $\frac{1}{4}$  in. diam. shanks. Incl.:  $\frac{3}{8}$ ,  $\frac{1}{4}$ ,  $\frac{1}{8}$ -in. straight-face bits;  $\frac{1}{2}$ -in. V-groove chamfering bit;  $\frac{1}{2}$ -in. core box bit;  $\frac{3}{16}$ -in. veining bit; double-end 45/60 V-groove bit. Sep. prices total \$24.03, page 107. 9 R 21218—Wt. 4 oz. . . Set \$19.99

**19 Router handbook** examines basic to advanced router operating techniques; describes accessories and their uses. Chapters on projects, sign making, router turning, etc. Over 50 projects; 600 illustrations; 224 pages. 9 R 25184—Wt. 1 lb. 5 oz. . . \$9.49

**20 "Making Wood Signs"** . . . 140-page manual describes how to select wood, plus how to lay-out and make wood signs. Includes chapters on designing, carving and sandblasting with over 100 illustrations. 9 R 2922—Wt. 10 oz. . . \$7.99

**21 175-page Craftsman router handbook** provides instructions on the use of your router, plus over 200 standard and special router accessory operations. Other chapters incl. features on portable drills, saws, sanders, power planers and rotary grinders. 9 R 2949—Wt. 13 oz. . . \$7.99

**22 Foot-actuated switch** for routers and drills lets you keep hands free. 8-ft. cord. Use on 125-volt up to 10 amps only. Non-skid rubber base. 9 R 25177—Wt. 2 lbs. . . \$29.99

**23 Craftsman face shield.** 8x11 $\frac{1}{2}$  inches wide. Adjustable head gear. 9 R 18613—Wt. 8 oz. . . \$12.79

**24 Letter and number sign-making template sets** let you carve letters and numbers in 1 $\frac{1}{2}$  and 2 $\frac{1}{2}$ -in. sizes for signs and plaques. Template holder has quick release clamp.  $\frac{1}{16}$  and  $\frac{3}{16}$  in. diam. bushings. Incl. 26 upper-case block letters and 10 numerals in 1 $\frac{1}{2}$  and 2 $\frac{1}{2}$ -in. heights. Fits all Sears and other routers. 9 R 2573—Wt. 2 lbs. 13 oz. . . \$13.99

Replacement template set includes 26 upper-case block letters in 1 $\frac{1}{2}$ , 2 $\frac{1}{2}$ -inch heights.  $\frac{1}{16}$ ,  $\frac{3}{16}$ -inch bushings. For (24) above and former 9-25182. 9 R 25181—Wt. 2 lbs. . . Set \$10.99

**25 Tool shelf** of high-impact plastic easily affixes to the wall or pegboard in your workroom. Measures 22Wx10 $\frac{1}{2}$ Dx3 $\frac{3}{4}$ H-in. Includes toggle bolts. 9 R 25122—Wt. 2 lbs. 8 oz. . . \$9.99  
\*Unassembled.

Our CRAFTSMAN® Router-Recreator turns your router into a carving tool for creating designs on gun stocks, spindles . . . even reproduces signs, shapes and figurines in original sizes!



Router recreator \$119.99

5-piece bit set \$14.99

Save \$27 when you buy both (12) and (13)



Door and panel decorating kit lets you create a variety of designs in doors, panels or drawers up to 24x36 inches wide



• SearsCharge and Discover Card . . . each is different, but together they're all you really need

• To apply for SearsCharge only CALL TOLL FREE 1-800-323-3274 • IN ILLINOIS CALL 1-800-942-7446



CRAFTSMAN Rout-A-Signer \$37.99

The power tool library



Activate your tool with our plug-in foot pedal control



23



CRAFTSMAN letter and number sign-making template set



Keep tools and bits within easy reach on this handy tool shelf!

# CRAFTSMAN® Router Accessories take those projects off your mind and into reality



Create interlocking joints like those in fine cabinetry and furniture with this Rail and Stile Router Bit Set

**1** 5-pc. carbide-tipped rail and stile cutter bit set. Create your own cabinet doors, paneled walls, wainscoting and the most professional-looking interlocking joint... like those found in fine factory furniture. Set includes 2-pc. carbide-tipped rail and stile cutter set; arbor, bushing and guide bearing. Use with CRAFTSMAN router tables.  
9 R 21257—Wt. 2 oz. . . Kit \$29.99



Make crown molding for decorative treatments on furniture and more using our Crown Molding Router Bit Set

**2** 7-pc. crown molding bit set makes various shapes of crown molding for use on furniture, panels. Kit incl.: V-groove bit, 1/2-in. carbide-tipped cove box bit, 1-in. end cove bit; 1/4-in. bead and chamfer bit; arbor, pilot set, case. Use with CRAFTSMAN router tables. Shipping weight 5 ounces.  
9 R 21255 . . . Kit \$39.99



5-pc. Tongue and Groove Router Bit Set



Box Joint Bit

**3** 5-piece tongue and groove bit set enables you to adjust the "fit" of the tongue and the groove producing exact fit you want. Incl. two carbide-tipped 1/4-in. groove cutting bits; hardened and ground precision arbor; steel spacers and nut. Can be used with a router table or edge guide.  
9 R 21260—Wt. 2 oz. . . \$29.99

**4** One-piece drawer joint and box joint bit is all that is required to cut a beaded dado joint when constructing drawers and boxes. Quickly and accurately cuts both the front and side. High hook cutting edge of durable carbide-tipped steel does the end grain cutting. Includes instructions. Wt. 1 oz.  
9 R 21262 . . . \$21.99

**5 thru 7** Perfectly align drawer fronts and sides from 1/8 to 1 1/8 in. using dovetail joint fixtures with your router. Channel plate, combs and clamps included.

**5** Only at Sears! "Hand cut"-style dovetail template. Old style dovetails are spaced apart and equally centered on all drawers up to 8 inches deep. For use with fixture (6) only. Requires bit (80) sold on page 107.  
9 R 25702—Wt. 14 oz. . . \$12.99

**6** For drawers up to 8 inches deep. Make 1/2 and 1/4-inch flush, 1/2-inch offset and rabbeted dovetail joints. Requires bits (64 and 65) sold on page 107. Includes guide bushings.  
9 R 2570—Wt. 3 lbs. 2 oz. . . \$27.99

**7** For drawers up to 12 in. deep. Makes 1/2, 1/4-in. flush, offset and rabbeted dovetail joints. Requires bit (64) sold on p. 107. Includes template for 1/4, 1/2-in. joints.  
9 R 2579—Wt. 5 lbs. 8 oz. . . \$39.99

Box Joint Templates for use with (7) above to make box joints.  
9 R 2580—Wt. 12 oz. . . \$15.99

**8** Guide Bushing Set guides bit as it moves over template. Use with (5) above. Steel plate has sleeve for bit. Incl. 3/16, 7/16, 9/16-in. diam. bushings.  
9 R 25082—Wt. 10 oz. . . Set \$7.49

**9** Craftsman multi-purpose router guide sets up easily... simply replace router sub-base with detachable portion of guide. Fits all Sears routers (except 9-1735). Router, bit not included. Wt. 1 lb. 8 oz.  
9 R 25179 . . . \$14.49

Router base (not shown) improves visibility for freehand and lettering work. 4-in. diameter hole. Plastic non-mar surface. Fits Sears routers (not incl.) except 9-1735.  
9 R 25086—Wt. 2 oz. . . \$2.49

**10** Make square or rounded hinges up to 5-in. long on 2 or 3-hinge doors. Incl. 3 template clamps; 3 1/2, 4-in. butt-hinge templates. Steel bars, aluminum templates. Req. guide bushings (8).  
9 R 2564C—Wt. 9 lbs. . . \$58.99

**11** Butt-hinge templates alone. Includes one 3 1/2-in. and one 4-in. long template. Requires guide bushings (8).  
9 R 2575—Wt. 11 oz. . . \$5.79

5-piece Kromedge steel edgeworker bit set with 1/4-in. diam. shanks. Includes 1/2-in. core box; 1/4-in. veining; 3/4-in. ogee end-cutter; 1/2-in. edge-rounding; 1/2-in. double-bead edging; plastic case. Separate prices total \$23.75 on page 107. Wt. 5 oz.  
9 R 21214 . . . Set \$16.99

11-piece router bit set is perfect for decorative edging. Kromedge steel bits have 1/4-in. diam. shanks. Incl. 3/8-in. cove bit; rabbet bit with pilot for 1/4, 5/16 and 3/8-in. rabbet cuts and 1 1/8-in. surface cut; 3/16-in. ogee bits; 1/4-in. Roman ogee bit; 3/8-in., 1/4-in. bead and quarter-round bits; 1/4-in. interchangeable arbor with 7/16-in., 9/16-in. solid-type pilots; case. Separate prices total \$44.92, p. 107. Shpg. wt. 1 lb. 6 oz.  
9 R 25422 . . . Set \$29.99

Bowl-crafter bits of Kromedge high-speed steel.  
9 R 21237—Outside-convex  
9 R 21238—Inside-concave  
9 R 21236—Straight turning  
Shpg. wt. 1 oz. . . Each \$4.99

3-pc. set of bowl-crafter bits. Sep. prices total \$14.97.  
9 R 21235—Wt. 3 oz. . . Set \$12.99

Drive Adapter for router-crafter allows cuts over full length of workpiece. Includes spindle and removable drive center for locating workpiece (interchanges with original spindle).  
9 R 25256—Wt. 12 oz. . . \$10.99

11-pc. router-crafter Kromedge bit set of high-speed steel has 1/4-in. diam. shanks. Incl. rabbet bit with pilot for 1/4, 5/16, 3/8-in. rabbet cuts and 1 1/8-in. surface cut; panel-raising bit, 7/8-in. V-groove chamfering bit; 9/32-in. point-cutting ogee bit; 3/16-in. point-cutting quarter-round bit; 1/2-in. core box bit; 1/4 in. veining bit; 1/4-in. interchangeable arbor with 7/16, 9/16-in. solid-type pilots. Sep. prices total \$43.42 on p. 107.  
9 R 21227—Wt. 8 oz. . . Set \$34.99

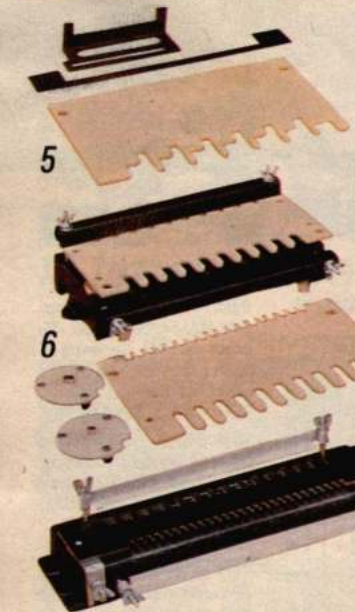

Dovetail Joint Fixtures

1/4, 1/2-in. flush      1/2-in. rabbet      1/2-in. offset



Guide Bushing Set



Make accurate edging, contour, even full 24-inch diameter circle cuts plus trim or bevel laminate using a single accessory... the CRAFTSMAN Multi-purpose Router Guide



Template Clamps let you quickly and accurately mortise doors, jambs and more

**12** Router-Recreator\* lets you make 3-dimensional figures up to 8x8 in. tall, signs, edge plaques, spindles. Steel yoke assembly and pulleys, plastic pulley-guard covers. Two 4x4 in. particleboard mounting blocks, shelf supports. 2 stylus rods with 3 tips (1/8, 1/4, 1/2 in.). 3/4 in. sleeve, hardware, instr. incl. 27 1/2x23 1/4 in. wide. Fits routers with 3 to 3 3/4-in. diam. motor body. 9 R 25189C—Wt. 38 lbs. . . \$119.99

**13** 5-pc. bit set (for 12). Kromedged steel with 1/4-in. diam. shanks. Incl.: 3/4, 1/2, 1/4 in. straight face; double-end 45/60 V-groove; x-long carving bit. 9 R 21216—Wt. 4 oz. . . Set \$14.99

Save when you buy (12) with bit set (13). Separate prices total \$134.98. Shpg. wt. 38 lbs. 9 R 25009C . . . Set \$107.98

**14** Incl. extruded aluminum guide rails; 8 clamps, 7 corner templates; 3 rail and stile templates; one set of blank corners to attach your own design. Requires 3/8-in. guide bushings sold on page 108. Fits 1/2-HP or larger router. Wt. 8 lbs. 8 oz. 9 R 25469C . . . \$79.99

3-pc. 1/2-in. decorating bit set of high-speed steel with carbide tips has 1/4-in. diam. shanks. Incl. ogee, classic and V-groove chamfering bit. 9 R 22115—Wt. 3 oz. . . Set \$27.99

1/2-inch ogee bit (not shown) 9 R 25584—Wt. 1 oz. . . \$13.29

1/2-inch classic bit (not shown) 9 R 25595—Wt. 1 oz. . . \$12.99

**15** Router pantograph\* carves 3-dimensional figures plus 2-dimensional drawings. Also makes forms, line drawings, letters and numbers. 40°, 50°, 60° reductions. Letters, numbers 3 1/2, 4 1/2, 5 1/2 in. high. Upper and lower case letter styles incl.: Old English, Oriental, Script, Modern and Computer (upper case only). Instr. Fits Sears routers, others with 6-in. diam. base. Router, patterns not incl. 9 R 25187C—Wt. 7 lbs. 8 oz. . . \$32.99

**16** 2-dimensional router pantograph\* is similar to (15). Makes line drawings; modern-style upper and lower case letters, numerals in 42°, 50°, 58° size reductions. Fits Sears routers, others with 6-in. diam. base. Plastic base, 6 1/2x10x1 1/2-in. diameter. Shpg. wt. 3 lbs. 11 oz. 9 R 25183C . . . \$15.99

Replacement stencil set has upper, lower case letter styles: Old English, Oriental, Script, Modern, (Computer upper case only). For (15 and 16). 9 R 2518—Wt. 1 lb. 13 oz. . . \$9.99

**17** Rout-A-Signer makes letters and numbers from 3/4 to 4 1/2 in. high. Accepts boards 2 to 10 in. wide, 1/2 to 2 in. thick, any length. Incl. router adapter, letter frame, steel bars, 26 upper-case letters and 10 numerals in 1 1/2 and 2 1/2-in. heights. Letters and numbers slant to right. Carousel holds templates for easy storage. Instr. incl. 30x22x2 1/2-in. high. Fits Sears and other routers with 6-in. diam. or smaller base. Router, bit not incl. Order bit set (18), right. Partially assembled. 9 R 2572C—Wt. 10 lbs. 4 oz. . . \$37.99

**18** 7-piece Rout-A-Signer Kromedged bit set of hi-speed steel has 1/4 in. diam. shanks. Incl.: 3/8, 1/4, 1/2-in. straight-face bits; 1/2-in. V-groove chamfering bit; 1/2-in. core box bit; 3/8-in. veining bit; double-end 45/60 V-groove bit. Sep. prices total \$24.03, page 107. 9 R 21218—Wt. 4 oz. . . Set \$19.99

**19** Router handbook examines basic to advanced router operating techniques; describes accessories and their uses. Chapters on projects, sign making, router turning, etc. Over 50 projects; 600 illustrations; 224 pages. 9 R 25184—Wt. 1 lb. 5 oz. . . \$9.49

**20** "Making Wood Signs" . . . 140-page manual describes how to select wood, plus how to lay-out and make wood signs. Includes chapters on designing, carving and sandblasting with over 100 illustrations. 9 R 2922—Wt. 10 oz. . . \$7.99

**21** 175-page Craftsman router handbook provides instructions on the use of your router, plus over 200 standard and special router accessory operations. Other chapters incl. features on portable drills, saws, sanders, power planers and rotary grinders. 9 R 2949—Wt. 13 oz. . . \$7.99

**22** Foot-actuated switch for routers and drills lets you keep hands free. 8-ft. cord. Use on 125-volt up to 10 amps only. Non-skid rubber base. 9 R 25177—Wt. 2 lbs. . . \$29.99

**23** Craftsman face shield. 8x11 1/2 inches wide. Adjustable head gear. 9 R 18613—Wt. 8 oz. . . \$12.79

**24** Letter and number sign-making template sets let you carve letters and numbers in 1 1/2 and 2 1/2-in. sizes for signs and plaques. Template holder has quick release clamp. 7/16 and 3/8 in. diam. bushings. Incl. 26 upper-case block letters and 10 numerals in 1 1/2 and 2 1/2-in. heights. Fits all Sears and other routers. 9 R 2573—Wt. 2 lbs. 13 oz. . . \$13.99

Replacement template set includes 26 upper-case block letters in 1 1/2, 2 1/2-inch heights. 7/16, 3/8-inch bushings. For (24) above and former 9-25182. 9 R 25181—Wt. 2 lbs. . . Set \$10.99

**25** Tool shelf of high-impact plastic easily affixes to the wall or pegboard in your workshop. Measures 22Wx10 1/2Dx3 3/4H-in. Includes toggle bolts. 9 R 25122—Wt. 2 lbs. 8 oz. . . \$9.99  
\*Unassembled.

Our CRAFTSMAN® Router-Recreator turns your router into a carving tool for creating designs on gun stocks, spindles . . . even reproduces signs, shapes and figurines in original sizes!



Router recreator \$119.99

5-piece bit set \$14.99

Save \$27 when you buy both (12) and (13)



Door and panel decorating kit lets you create a variety of designs in doors, panels or drawers up to 24x36 inches wide



CRAFTSMAN Rout-A-Signer \$37.99

The power tool library



ONE QUALITY NAME

**CRAFTSMAN**

OFFERS MORE GOOD CHOICES

Our sabre saws work hard to give you high-quality, accurate cuts



1/6-HP two-speed sabre saw  
**\$18<sup>99</sup>**



1/5-HP variable-speed sabre saw  
**\$27<sup>99</sup>**



1/4-HP variable-speed sabre saw  
**\$37<sup>99</sup>**



1/4-HP variable-speed sabre saw with manual scroller  
**\$47<sup>99</sup>**



1/4-HP sabre saw  
**\$57<sup>99</sup>**

- ✓ Variable-speed control so you choose the speed to fit the job
- ✓ Autoscroller permits accurate cuts in virtually any design
- ✓ You can execute circle cuts, plunge cuts, miter and/or bevel cuts, pipe cutting... even edge cutting when properly accessorized
- ✓ Starts its own cuts without pre-drilling



6 Save 25% on sabre saw case when you also buy a sabre saw

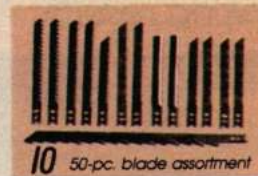

10 50-pc. blade assortment



7 Wood sign kit... for router, sabre saw or band saw



8 Blade/bit holder



9 Circle-cutting and straight-edge guide

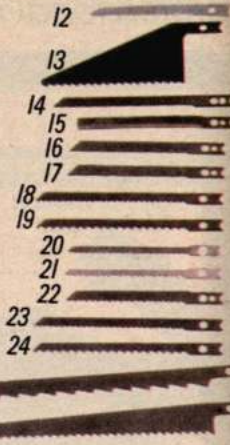

Individual sabre saw blades

1 thru 5 Slice thru cutting jobs with speed and accuracy using Craftsman sabre saws. Variable speeds from 0-3000 strokes per minute except (1), which has two speeds 2600/3000 spm. The steel base with bevel scale tilts 45° left or right for bevel cuts; 1 blade opening (blade not incl.). Built-in sawdust blower helps keep cutting line clear. Sleeve bearings. (5) has ball/sleeve bearings. Warranted\*.

Sabre Saw	(1) 1/6-HP	(2) 1/5-HP	(3) 1/4-HP	(4) 1/4-HP	(5) 1/4-HP
Scrolling Mechanism	none	none	none	manual	automatic
Switch	Slide-type			locking trigger	
Blade stroke	1/2-in.		3/4-in.	3/4-in.	
Guide accessories (incl.)	none	straight-edge	Circle-cutting/straight-edge		
Catalog Number	9 R 1714	9 R 1716	9 R 1070	9 R 1072	9 R 17210
Shipping weight	4 lbs. 11 oz.	4 lbs. 13 oz.	5 lbs. 8 oz.	5 lbs. 13 oz.	6 lbs. 4 oz.
Price	<b>\$18.99</b>	<b>\$27.99</b>	<b>\$37.99</b>	<b>\$47.99</b>	<b>\$57.99</b>

6 This Permanex® polyethylene tool case will not rust or corrode. 9 3/4x12Wx4-in. deep. Wt. 2 lbs. 9 R 14778... Alone **\$13.99** When you also buy sabre saw... **\$10.49**

7 Wood sign kit includes over 100 paper templates in clock and old English letter styles. Use with sabre saw, router or band saw to make signs 6, 8 or 10 in. high. Also incl. carbon paper, tracing cover and instructions. 9 R 25176—Wt. 1 lb. 8 oz... Kit **\$9.99**

\*Warranted by Sears. Write for free copy, see p. 148.

8 Blade/bit holder attaches to tool cord. Snap-open lid. Fits Craftsman sabre saws and drills. 9 R 2871—Shpg. wt. 2 oz... **\$3.49**

9 Circle-cutting/straight-edge guide helps you make accurate circles, intricate curves or straight lines. 9 R 27959—Shpg. wt. 7 oz... **\$3.99**

10 14-blade assortment incl. 2 ea. (14, 16, 17, 22, 23, 24), 1 ea. (15, 25) sold separately below. 9 R 28576—Wt. 3 oz... Set **\$9.99**

11 50-blade assortment set with case. 10 ea. (14, 16, 21, 22, 24). 9 R 28574—Wt. 10 oz... Set **\$24.99**

12 thru 26 CRAFTSMAN sabre saw blades are carefully designed to handle specific cutting jobs so you can get dependable, long-lasting cutting action. Wood cutting blades are made of high-carbon steel, heat-treated and austempered for durability. Metal cutting blades are made of tough, heat-treated M-2 high-speed steel. Our finest sabre saw blades are these bi-metal blades (12)... they have high-speed steel teeth and high-carbon steel back for flexibility, durability. Individually ground teeth provide sharpest possible edge. Fit all CRAFTSMAN, Skil, Black & Decker and most other major brands of sabre saws.

Type Cut	Item	Teeth per in.	Uses	Length in.	Pkg of	Catalog Number	Wt. oz.	Per Pkg.	
	(12)	18	Cuts fiberglass, aluminum, sheet metal, steel, comp. materials, laminated counter tops.	3	2	9 R 28777	1	<b>\$2.99</b>	
		6	Cuts nail imbedded wood.	4	2	9 R 28778	1	<b>2.99</b>	
Special material cuts	(14)	14	All-purpose, wood, plywood to 3 in. Non-ferrous metals, plastics, 1/2 to 2 in.	3 1/2	2	9 R 2874	2	<b>1.79</b>	
		Knife edge	Smooth cuts in rubberboard, cardboard, tile, leather, rubber or carpet up to 1/2 in. thick.	3 1/2	10	9 R 28745	1	<b>8.29</b>	
Special-purpose cuts	(13)	7	Flush wall, joint cuts, wood cuts to 3 in.	3 1/2	1	9 R 2877	1	<b>1.89</b>	
		(25)	3	Angle cuts in wood to 5 in. by saws with 1-in. or longer blade stroke.	6	1	9 R 2879	1	<b>1.89</b>
Metal cuts	(16)	24	Non-ferrous metal, brass copper and aluminum 1/4 to 1/2 in. thick.	3	2	9 R 28702	2	<b>1.69</b>	
		(17)	32	Mild ferrous metals, steel rods, pipe, sheet metal up to 1/4 in. thick.	3	10	9 R 28705	2	<b>7.99</b>
Rip cuts	(18)	10	Fast cuts in wood up to 3 in.	3 1/2	2	9 R 28706	2	<b>1.79</b>	
		(19)	7	Fast cuts in wood up to 3 in. thick.	3	10	9 R 28706	2	<b>7.99</b>
Finish cuts	(20)	20	Extra-fine cuts in wood, plastic, laminate to 1 1/2 in.	3 1/2	2	9 R 28726	1	<b>1.29</b>	
		(21)	10	Intricate scroll cuts in wood, plastic, laminate to 1 1/2 in. thick.	3	2	9 R 28711	1	<b>1.99</b>
		(22)	10	Fine cuts in wood, plywood or veneer up to 1 1/2 in. thick.	3	2	9 R 2876	1	<b>1.79</b>
Regular cuts	(23)	10	Smooth cuts in wood up to 3 in.	3	10	9 R 28764	1	<b>8.29</b>	
		(24)	7	Wood to 3 in. incl. 1x4's, 2x4's.	3 1/2	2	9 R 28712	2	<b>1.59</b>
		(26)	7	Wood up to 5 in. thick incl. 4x4's.	3 1/2	10	9 R 28712	2	<b>6.99</b>

# Introducing our all new CRAFTSMAN® Circular Saws . . . we've got the horsepower to stand-up to any job!



1 7 1/4-inch, 1 1/2-HP Saw \$27<sup>99</sup>



2 Available in 2 Catalog only! 7 1/4-inch, 2-HP Saw \$37<sup>99</sup>



3 7 1/4-inch, 2 1/2-HP Saw \$47<sup>99</sup>



7 1/4-inch, 2 1/2-HP Saw \$57<sup>99</sup>

1 thru 4 Motor delivers no-load speed of 5000 rpm. Rear sawdust blower. Trigger switch with lock for added convenience. Includes blade. 6-ft. cord. Warranted.\*

Circular saws	(1) 7 1/4 in. 1 1/2-HP	(2) 7 1/4 in. 2.0-HP	(3) 7 1/4 in. 2 1/2-HP	(4) 7 1/4 in. 2 1/2-HP
Blade guard	Thermoplastic			
Depth of cut at 90°	0-2 1/4 in.	0-2 1/4 in.	0-2 1/4 in.	0-2 1/4 in.
at 45°	0-1 3/4 in.	0-1 1/4 in.	0-1 1/4 in.	0-1 1/4 in.
Bearings	sleeve roller	sleeve roller	sleeve roller	ball, roller, sleeve
Shpg. wt.	11 lbs.	11 lbs. 14 oz.	12 lbs. 12 oz.	12 lbs. 12 oz.
Catalog No.	9 R 10921	9 R 10922	9 R 10923	9 R 10924
Price	\$27.99	\$37.99	\$47.99	\$57.99

5 CRAFTSMAN 1/8-in. circular saw cut-off wheels cut metal, flagstone, masonry, etc. Fit 1/2-in. and 3/8-in. arbor. Not for use on table saws or wood.

Diam.	Catalog Number	Wt.	Price
Aluminum oxide for metals			
6 in. . . .	9 R 64683	5 oz.	\$4.79
7 in. . . .	9 R 64684	9 oz.	4.79
8 in. . . .	9 R 64685	10 oz.	5.69
Silicon carbide for flagstone, masonry			
6 in. . . .	9 R 64661	6 oz.	\$4.99
7 in. . . .	9 R 64662	8 oz.	4.99
8 in. . . .	9 R 64663	9 oz.	5.69

6 This Permanex® polyethylene case will not rust or corrode. 12 1/2 x 16 1/2 x 9 1/2 in. D. Wt. 3 lbs. 5 oz. 9 R 14702 . . . Alone \$18.99 When you also buy saw . . . \$14.24

7 CRAFTSMAN circular saw guide lets you make accurate square, bevel or angle cuts. Saw (not incl.) moves along guide for precise cuts. Has 18 1/2-in. cutting reach. 15-in. on 90° cutting capacity. Not for use with worm-drive saws. 9 R 1720—Wt. 3 lbs. 7 oz. . . \$27.99

Rip guide (not shown) for circular saws (1) and (2). 9 R 27679—Wt. 7 oz. . . \$3.99

8 Complete your project with our CRAFTSMAN circular saw cutting and finishing guide that makes crosscuts, joints, bevels. Also adapts to routers. Cut lumber of any length and to 2 in. thick x 12 in. wide at any angle up to 45°. 9 R 1725L—Wt. 22 lbs. . . \$52.99

Aluminum cutter's edge (not shown) makes up to 8-ft. long straight cuts. Use with circular saws, sabre saws, routers or cutting knives (not included). 9 R 17168C—Wt. 3 lbs. 4 oz. . . \$19.99

9 CRAFTSMAN miter maker is ideal for picture frames, window moldings. Makes 0-45° cuts in stock up to 2 in. thick. Max. cut is 3 3/8 in. with 7 1/2-in. blade (not incl.). Incl. 2 guide fences (adjustable), scale for angle cuts and stop length gauge. 21 x 17 1/2 x 7 1/4 in. h. Fits Sears and most other circular saws (not incl.). 9 R 17164C—Wt. 11 lbs. 2 oz. . . \$34.99

10 Two 51-in. extruded aluminum rails connect with joiner (incl.) for 8 1/2-ft. cutting reach. One rail has 2 bubble levels for horizontal and vertical leveling. 14-in. protractor has double-graduated scale, 0°-180°. Spring tension. Wt. 3 lbs. 12 oz. 9 R 17171C . . . \$29.99



5 CRAFTSMAN 1/8-inch Circular saw Cut-off Wheel

Protect your circular saw . . . surround it with a CRAFTSMAN Tool Case and **Save 25%** when you also buy a circular saw



6



7 CRAFTSMAN Saw Guide



8 Available in Catalog only! Cutting/finishing Guide



9 CRAFTSMAN Miter Maker



10 Available in Catalog only! Improve cutting accuracy with our 4-in-1 Cutting Edge

\*Warranted by Sears. Write for free copy, see page 148.

**CRAFTSMAN**

*Cordless sabre saw gets the job done anywhere, anytime. Recharges in only 4 hours or can be left to charge continuously for use when needed! Special blade clamp allows blade to be mounted at right angles for greater versatility*

*Ideal for the do-it-yourselfer or tradesman, this 3/8-in. stroke saw has no-load speed of 2400 SPM for smooth cuts. Bevel cuts up to 45° left, right; flush cuts up to wall with proper blade. Roller guide gives smoother cutting action with less blade breakage. Retractable chip shield for easy blade changes. Two finger trigger switch with lock off. Ball, sleeve, roller bearings. Spur gearing. Takes 1/4-in. shank blades sold on p. 608A. LED charge indicator. UL listed. Hi-impact polymer housing. Incl. charger, rip fence. Warranted\*. Shpg. wt. 4 lbs. 8 oz. 9 R 17249...\$67.99*



**CRAFTSMAN® Cordless Tools turn any location into a working job site**

- ✓ Eliminate the need for outside power to be brought in before work can start... minimize down time
- ✓ Reduce possible safety hazards such as tripping over tangled cords or shock from improperly grounded tools
- ✓ Offer total freedom for working inside or outside... you're no longer restricted by the length of your extension cord
- ✓ Quick recharge times, long battery life
- ✓ Over 60 years of traditional CRAFTSMAN quality and warranted by Sears.

**Screwdrivers have high-torque motors for long lasting durability and efficiency... reverse to remove stuck screws and bits**



*Slim, in-line screwdriver has quadruple reduction gearing for added torque and a no-load speed of 140 RPM. Quick 3-hr. recharge time*

**\$18<sup>99</sup>**

**1** Screwdriver has easy to use rocker-type forward/reverse switch. Offset spindle for use in tight places; spindle lock allows manual use. LED charge indicator. Powered by 2 nickel-cadmium batteries. Incl. charger, 2 double-ended bits (Phillips, slotted) and cradle. Warranted\*.

9 R 11123—Wt. 1 lb. 8 oz...\$18.99

Replacement energy pack for 9-11217 (not shown). 9 R 11122—Shpg. wt. 14 oz...\$29.99



*Screwdriver has pistol-grip design for comfortable use. High torque motor develops 140 RPM. Quick 3-hr. recharge time*

**\$24<sup>99</sup>**

**2** Screwdriver uses trigger-type rocker switch to control forward/reverse. Quadruple reduction gearing for added torque. Spindle lock allows manual use. LED charge indicator.

Powered by 2 nickel-cadmium batteries. Incl. charger, two double-ended bits (Phillips and slotted), cradle. Warranted\*.

Shpg. wt. 1 lb. 8 oz. 9 R 11120...\$24.99



*Screwdriver uses planetary gearing to provide added torque; variable torque clutch adjusts to prevent over-tightening of screws. Quick 3-hr. recharge time*

**\$32<sup>99</sup>**

**3** No-load speed of 140 rpm. Trigger-type rocker switch controls forward/reverse. Comfortable pistol grip handle. Built-in bit storage. LED charge indicator. Powered by 3 nickel-cadmium batteries. Recharges up to 1000 times. Incl. charger, 2 double-ended bits (Phillips and slotted), cradle. Warranted\*.

9 R 11124—Wt. 1 lb. 2 oz...\$32.99

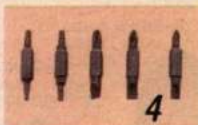

**4** 5-pc. 1/4-in. hexagon double-ended power screwdriver bit set incl. No. 2 Phillips/8-10 slotted, No. 3 Phillips/6-8 slotted, No. 1 Phillips/6 slotted and 2 Torx bits (T 15/T 20, T 25/T 30). 9 R 25602—Shipping weight 1 ounce...\$4.99

*Pkg. of two 1/4-in. hexagon double-ended bits. No. 2 Phillips/8-10 slotted. 9 R 25603—Shpg. wt. 1 oz...Pkg. \$1.49*  
*No. 3 Phillips/6-8 slotted. 9 R 25604—Shpg. wt. 1 oz...Pkg. \$1.49*

**High torque 3/8-in. cap. drills recharge in as little as 1 hour!**



*Two-speed reversing drill uses planetary gearing for increased torque. Quick 3-hr. recharge time*

**\$27<sup>99</sup>**

**5** Drill has 300 rpm low speed for easy starting, drilling in metal or starting screws and 600 rpm high speed for drilling soft materials. Pistol-grip handle for firm control. LED charge indicator. Powered by 5 nickel-cadmium batteries. Trigger switch controls speeds. Incl. charger and chuck key. Warranted\*.

Shpg. wt. 3 lbs. 12 oz. 9 R 11125...\$27.99  
\*Write for free copy, see p. 148.

*Two-speed 6-cell reversible drill has greater torque and increased operating time between charges. Recharges in 3 hours*

**\$47<sup>99</sup>**

**6** Two speed drill operates at 300 rpm-low, 600 rpm-high. Powered by 6 nickel-cadmium batteries, drill delivers greater torque and operates longer on a single charge. LED charge indicator. Trigger switch controls speeds. Incl. charger, chuck key. Warranted\*.

9 R 11126...\$47.99  
Repl. battery pack for 9-11122 (not shown). Wt. 1 lb. 9 R 11121...\$27.99



*Two-speed reversible drill has removable 6-cell battery pack for convenience. Just place old pack in charger and pop in new one for continuous drilling. Quick 3-hr. recharge time*

**\$57<sup>99</sup>**

**7** Drill has same features as (6) plus removable 6-cell battery pack that plugs directly into charger. With additional pack below, drill can remain in use. LED indicator. Automatic circuit breaker protects drill from overload; resets automatically. Incl. one battery pack, charger, chuck key. Warranted\*.

9 R 11127—Wt. 4 lbs...\$57.99  
Replacement battery pack for (7) above. 9 R 11114—Wt. 14 oz...\$26.99

*Variable speed reversible drill has variable torque clutch to prevent the overtightening of screws. Removable high-capacity, 6-cell quickcharge battery pack with super-fast 1-hr. recharge time*

**\$67<sup>99</sup>**

**8** Drill has trigger controlled speeds of 0-600 rpm. May be used continuously with purchase of additional battery pack below. Automatic circuit breaker protects against overload. Built-in chuck key holder. Incl. charger, battery pack, chuck key. Warranted\*.

Shpg. wt. 6 lbs. 8 oz. 9 R 11128...\$67.99  
**9** Replacement battery pack for (8). 9 R 11115—Wt. 14 oz...\$26.99



*Feel the difference quality makes with our finest cordless reversible drill*

- ✓ High capacity 8-cell battery has more output and superfast 1-hr. recharge time
- ✓ Planetary gear system for added torque
- ✓ Adjustable variable clutch helps prevent overtightening of screws

**\$89<sup>99</sup>**

**10** Our best cordless drill has trigger-operated reversible speeds of 0 to 600 rpm. Precision-balanced motor and improved gearing transmit more power with less vibration. Automatic circuit breaker protection. Built-in chuck key holder. Incl. charger, battery pack, chuck key. Warranted\*.

Shipping weight 7 lbs. 3 oz. 9 R 11132...\$89.99  
Replacement battery pack for (10) above. 9 R 11116—Wt. 1 lb...\$28.99

## CRAFTSMAN® wood-handle knives



**Save 20%**  
on these accessories  
when you also purchase  
any knife on this page



**16** Shrade honing kit\*\* incl. 6x1½x  
1¾-in. double-grit stone (coarse,  
fine), oil, 2 washable cloths, instr.  
9 R 95508—Wt. 1 lb. Kit alone \$14.99  
Kit when you also buy  
any knife on page... \$11.99

**17** Mahogany-colored vertical  
leather sheath. 2 in. wide loop.

Capacity Closed	Catalog Number	Wt. oz.	Alone	With knife
4 in.	9 R 95084	1	\$4.79	\$3.83
5¼ in.	9 R 95083**	2	6.99	5.59

**18** Mahogany-colored leather  
sheath\*\* fits knives up to 3½ in.  
closed. Fits belts to 1½ in. wide.  
9 R 95082—Wt. 1 oz. . . Alone \$6.99  
Sheath when you also buy  
any knife on page... \$5.59

**19** Alumina ceramic sharpening rod  
set\*\* with 9-in. cedar base incl.  
handy storage pouch, instr.  
9 R 95147—Wt. 6 oz. . . Alone \$7.99  
Set when you also buy  
any knife on page... \$6.99  
\*\*Available at Sears only in catalog.

## Knives with tough T. P. R.† handles



Classic  
bone-handle knives

Stainless steel  
gentleman's  
pocket knife

## Knives on the cutting edge of sharpness

**1** thru **6** Laminated hardwood handles  
add warmth and personality  
to knives that feature stainless steel  
blades with super sharp A.C.A. edges,  
solid brass bolsters and linings.  
Warranted by Sears, write for free  
copy, see p. 148.

**1** Jack knife has clip, pen blades. 3¼  
in. long when closed.  
9 R 95202—Shpg. wt. 5 oz. . . \$12.99

**2** Large stock knife has clip, spey and  
sheepfoot blades. 4 in. long when  
closed.  
9 R 95204—Shpg. wt. 5 oz. . . \$18.99

Stock knife (not shown) like (2), but  
smaller. 3¼ in. long closed.  
9 R 95203—Shpg. wt. 5 oz. . . \$14.99

**3** Pen knife features clip and pen  
blades. Slim design fits easily in  
pockets. 2½ in. long when closed.  
9 R 95201—Shpg. wt. 3 oz. . . \$11.99

**4** Large lockback knife locks blade in  
place. Incl. leather sheath. 4½ in. in.  
long when closed.  
9 R 95206—Shpg. wt. 13 oz. . . \$28.99  
Lockback knife like above but smaller.  
4 in. long when closed. No sheath.  
9 R 95205—Shpg. wt. 6 oz. . . \$18.99

**5** Specially made CRAFTSMAN 60th  
Anniversary commemorative knife  
has original CRAFTSMAN logo etched  
on blade. Nickel silver bolsters.  
Polished handle. 3½ in. closed.  
9 R 95114—Shpg. wt. 6 oz. . . \$24.99

**6** Utility knife has spear blade,  
screwdriver/cap lifter, saw blade,  
coping blade, can opener. 3¾ in. long  
when closed.  
9 R 95210—Wt. 1 lb. 6 oz. . . \$23.99

**7** and **8** T.P.R.† handles are resistant  
to temperature extremes, oil,  
grease, moisture. Blades have extra-  
sharp A.C.A. edge. Nickel-silver  
bolsters. Warranted by Sears, write for  
free copy, see p. 148.

**7** Stock knife has clip, spey and  
sheepfoot blades. Brass linings. 4  
in. long when closed.  
9 R 94608—Shpg. wt. 6 oz. . . \$23.99

**8** Lockback knife has 1-pc. bolster,  
lining. Incl. sheath. 4½ in. long  
when closed.  
9 R 94609—Shpg. wt. 13 oz. . . \$33.99

**9** and **10** Available only in catalog.  
BUCK™ knives have solid  
brass bolsters. Warranted by Buck,  
write for free copy, see p. 148.

**9** Knife has finger-grooved ebony  
handle with stainless steel blade.  
Solid brass lining. Leather sheath. 4½  
in. long when closed.  
9 R 95135—Shpg. wt. 11 oz. . . \$49.99

**10** Bucklite™ knife features a rugged  
Valox™ plastic handle with high  
chrome, carbon steel blade. Valox™  
lining. Nylon sheath. 4 in. long closed.  
9 R 95120—Shpg. wt. 4 oz. . . \$25.99

**11** thru **14** Bone-handle knives have  
stainless steel blades,  
nickel alloy bolsters, solid brass linings.  
Imported. Warranted by Sears, write for  
free copy, see p. 148.

**11** thru **13** Knives have double-cut  
bone handles and eagle  
etched on largest blade.

**11** "Trapper type" knife has clip, pen  
blades. 3¼ in. long when closed.  
9 R 95155—Shpg. wt. 4 oz. . . \$14.99

**12** Lockback knife is 4½ in. long  
when closed.  
9 R 95148—Shpg. wt. 10 oz. . . \$29.99

Lockback knife like above but smaller  
(not shown). 3½ in. long closed.  
9 R 95144—Shpg. wt. 4 oz. . . \$24.99

**13** Stock knife has clip, spey and  
sheepfoot blades. 4 in. long closed.  
9 R 95157—Shpg. wt. 4 oz. . . \$24.99

**14** Smooth, polished bone handle  
adds elegance to this knife which  
has 2 pen blades. 3 in. long closed.  
9 R 95154—Shpg. wt. 2 oz. . . \$12.99

**15** Slim lockback knife is made  
entirely of stainless steel for  
durability and contemporary elegance.  
3½ in. long when closed.  
9 R 95152—Shpg. wt. 4 oz. . . \$12.99  
†T.P.R.—Thermoplastic rubber.



Steel number and letter  
stamps personalize your tools  
and belongings for identification

**20** Steel stamp set with faces hardened to 60-63  
Rockwell on the C scale. Square shank has  
grooved grips. Tempered hammer end. Available in  
letters (A-Z), numbers (0-9, .) or combination sets.  
Save \$1 over sep. prices when you buy combination  
set.

Size in.	Type	Catalog Number	Shpg. wt.		Set Price
			lbs.	oz.	
½	Numbers	9 R 37912	8		\$6.99
¾	Numbers	9 R 37913	12		7.99
¾	Numbers	9 R 37914	1	1	9.99
¾	Letters	9 R 37924	1	7	16.99
¾	Letters	9 R 37925	2	3	19.99
¾	Letters	9 R 37926	3	2	24.99
¾	Combination	9 R 61192	2		22.98
¾	Combination	9 R 61193	2	14	26.98
¾	Combination	9 R 61194	4	2	33.98

## Turn rough stones into polished jewelry with rock tumblers

**21** and **22** Bring out the true beauty  
hidden inside those plain,  
ordinary rocks when you polish off the  
rough edges. Rocks are mixed with  
water, abrasive media and tumbled  
until smooth and polished. Molded  
rubber barrel tumbler. Incl. rock  
assortment, 4 grades of polishing  
abrasive, jewelry findings, guide book.  
UL listed.

**21** Ideal for the beginner, tumbler has  
3-lb. cap. barrel, impedance  
protected motor. 6-ft. cord.  
9 R 53017—Wt. 8 lbs. . . \$59.99

**22** Versatile two barrel, 6-lb. cap.  
tumbler is ideal for turning small  
batches of single-type stones into  
jewelry or for brass polishing. Heavy-  
duty, fan cooled motor with overload  
protection. 6-ft. cord.  
9 R 53018—Wt. 10 lbs. . . \$69.99



3-lb. capacity  
rock tumbler

6-lb. capacity  
rock tumbler



## CRAFTSMAN compact rotary tools

are ideal for precision modeling and fine detailing

Variable speed tool with pencil-type handle lets you concentrate on the work instead of the tool!

**CRAFTSMAN® table-top hobby tools** combine power with precision control for results a professional would be proud of

**YOUR CHOICE \$94.99**

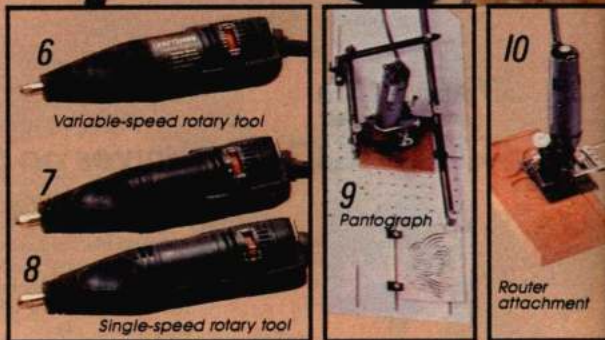

CRAFTSMAN table-top tools are compact, powerful and versatile enough for most hobbyists. Warranted\*.

**1** Compact disc-belt sander has 6x3-in. fixed table for belt sanding, 45° tilting table with miter gauge for disc sander. Two 1x30-in. sanding belts incl. Removable belt support for flexible or rigid external sanding. Belt moves at approx. 2700 ft. per min. 3-in. throat depth for internal sanding. Incl. 5-in. adhesive-backed sanding disc. Disc revolves at 4400 rpm. Steel base, table. 11x10x15 in. high. Universal 2.0 amp motor. UL listed. AC. 6-ft., 3-wire cord. 9 R 2476—Wt. 11 lbs. . . . **\$94.99**

**2** Scroll saw-sander with direct-drive motor provides enough power to handle most hobby projects, yet is compact enough for closet storage. Make intricate cuts in soft wood up to 1½-in., hardwood to ½-in. and aluminum to ⅜-in. thick. Table is 8x9½ in. long, tilts up to 45° left or right for bevel cuts. 15-in. throat depth. Side-mounted accessory power take-off drive for disc sanding or grinding. Kits sold at right. Incl. 4 in. disc sander, four 3-in. pin-end blades, adj. guard, rubber sanding pad and adapter. Steel construction. Motor delivers 3450 strokes per min. UL listed. AC. 6-ft., 3-wire cord. Shpg. wt. 17 lbs. 9 R 2472C . . . **\$94.99**

Package of six 4-in. diam. sanding discs with ¼-in. holes for (2) incl. 2 of each: fine, medium, coarse. 9 R 2544—Wt. 2 oz. . . . Pkg. **\$2.49**

1x30-in. cloth-back aluminum-oxide sanding belts for (1). Pkg. of 2.

Grade	Grit no.	Catalog Number	Wt. oz.	Pkg.
Fine	120	9 R 24765	3	<b>\$4.79</b>
Medium	80	9 R 24764	3	<b>4.79</b>
Coarse	50	9 R 24767	3	<b>4.79</b>

5-in. zinc stearate adhesive-backed sanding discs for (1).

Grade	Grit no.	Pkg. of	Catalog Number	Wt. oz.	Pkg.
Fine	120	5	9 R 30051	1	<b>\$2.69</b>
Medium	60	5	9 R 30052	1	<b>2.69</b>
Coarse	40	4	9 R 30053	1	<b>2.69</b>

**3** Deluxe scroll saw-sander kit for (2) incl. flexible shaft rotary tool attachment; ⅜-in. twist drill; drum sander; 6 fine sander bands; wire wheel brush; bristle cup brush; 6 felt polishing wheels; felt polishing tips; mandrel; polishing compound; abrasive stone; right angle, open end wrenches. 9 R 53172—Wt. 14 oz. . . . Kit **\$28.99**

**4** 30-pc. scroll-saw sander accessory kit for (2) incl. 10 fine-tooth, 5 coarse-tooth blades; 4 of each: coarse, medium, fine sanding discs; two 3-in. buffing wheels; buffing compound. 9 R 53171—Wt. 8 oz. . . . Kit **\$13.99**

\*Warranted by Sears, write for free copy, see p. 148.

**5 thru 8** These compact rotary tools take accessories with up to ⅜-in. shank, sold on facing page. Collet wrench, instr. incl. 6-ft., 2-wire cord. Warranted\*.

**5** Variable-speed rotary tool has a flexible shaft attached to a slim, pencil-type handle for precision control with less fatigue. Develops 7,500 to 25,000 rpm. 3-position switch changes from variable to max. speed. Series wound motor for high torque. 9 R 25147—Wt. 4 lbs. 8 oz. . . . **\$94.99**

**6** Variable speed tool lets you match the speed to the job. Specially designed motor develops 5,000 to 30,000 rpm and has ball bearing construction for increased tool life. Tapered housing has fingertip pad to increase comfort and lessen user fatigue. 9 R 61003—Wt. 1 lb. 11 oz. . . . **\$47.99**

**7** Tool develops 15,000 and 30,000 rpm. Ideal for general purpose work. Shpg. wt. 1 lb. 11 oz. 9 R 61004 . . . **\$39.99**

**8** Tool develops 30,000 rpm. 9 R 61001—Wt. 1 lb. 11 oz. . . . **\$27.99**  
Available in Catalog only! CRAFTSMAN solid state motor speed control for (8) or appliances to 5 amps. UL listed AC. 9 R 25144—Wt. 2 lbs. 1 oz. . . . **\$34.99**  
Polyethylene storage case for (7, 8). 9 R 25148—Shpg. wt. 1 lb. . . . **\$7.99**

Accessory case keeps rotary tool accessories organized. 2x5 ½x2 ¾-in. 9 R 53051—Wt. 3 oz. . . . **\$1.99**

**9** Available in Catalog only! Pantograph fits rotary tools and engravers to make two-dimensional carvings, signs and drawings. Reduces patterns. Incl. 3 letter styles (Monogram, Olde English and Script), 10 numerals, 6 line drawings, instr. 9 R 26002C—Wt. 5 lbs. . . . **\$15.99**

Save 19% when you buy this 49-piece general accessory set. Incl. wire brush, engraving cutter, drum sander, 6 sander bands, 36 emery cutting wheels, mandrel, abrasive cone, disc, ⅜-in. collet. Separate prices total \$16.11 on facing page. 9 R 53060—Wt. 2 oz. . . . Set **\$12.99**

**10** Router attachment fits rotary tools above to add even more flexibility. Cuts rabbets, dado, mortise, chamfers and more. Has calibrated depth gauge with removable edge guide. 9 R 53093—Shpg. wt. 13 oz. . . . **\$14.99**

Available in Catalog only! Save 13% when you buy this 61-pc. advanced set. Incl. 49-pc. set above plus abrasive cylinder, silicon grinding point, cutting saw, 7 polishing wheels, mandrel, polishing compound. Separate prices total \$28.82 on facing page. 9 R 53067—Wt. 5 oz. . . . Set **\$24.99**

## Security and hobby accessories

Discourage thieves by marking valuables for identification



**11** CRAFTSMAN heavy-duty electric security engraver kit has a tungsten-carbide tip that adjusts for glass, wood, copper, brass or plastic. Repl. tip sold below. Incl. indelible ink pen for marking clothes, tools, etc., "Stop Thief" warning stickers, plastic template for letters ¼-in. high. Instr. incl. Warranted\*. 9 R 61197—Wt. 1 lb. . . . Kit **\$18.99**

**12** Sears household electric security engraver kit has same features as above except for smaller motor. Not for use on glass. 9 R 61196—Wt. 12 oz. . . . Kit **\$9.49**  
Replacement tungsten-carbide tip for (11, 12). 9 R 52861—Wt. 1 oz. **\$3.99**

**13** Security marking kit incl. steel scribe pen, indelible ink pen, "Stop Thief" warning stickers, template with ¼-in. letters, instructions. 9 R 61195—Wt. 1 oz. Kit **\$3.49**

**14** Available in Catalog only! Woodburning set has iron which develops 950°F. Four interchangeable points include all-purpose, fine-point, grading and script points. Incl. 12 oil-base pencils, craft patterns, stand, case. 9 R 25195—Wt. 2 lbs. . . . Set **\$34.99**

Available in Catalog only! Woodburning tool with 3 points (all-purpose, script, grading); stand. 9 R 25193—Shpg. wt. 8 oz. . . . **\$19.99**

**15** Wood sign kit includes over 100 templates in block, Olde English and script styles. Use with scroll saw or router to make signs 2, 3 or 4 in. high. Kit includes carbon, tracing paper, instructions. 9 R 25196—Wt. 8 oz. . . . **\$9.99**

**16** Guide to Compact Rotary Tools has 266 pages of practical information concerning the uses of tools. Illustrated. Paperback. 9 R 25162—Wt. 1 lb. 4 oz. . . . **\$7.95**



Cut, grind, engrave, sand and polish your way to perfection and **Save 10%** on any 2 or more rotary tool accessories (1-35)

Increase the usefulness of your compact rotary tool with accessories that grind, polish, sand, engrave, and so much more. All with 1/8-in. shank except (9), 53076, 53074 have 3/32-in. shank. (23, 26) pkg. of 36, (24) pkg. of 5 and 53083-sander bands: pkg. of 6. Shipping weight ea. 1 oz. except 53098—7 oz.

Item	Description	Catalog Number	Price, ea.	Any 2 or more ea.
(1)	Cylinder Steel Cutter	9 R 25008	\$3.89	\$3.50
	Pointed Steel Cutter	9 R 25011	3.89	3.50
	Ball Steel Cutter	9 R 25012	3.89	3.50
(2)	Pointed Steel Cutter	9 R 53101	3.89	3.50
	Round Steel Cutter	9 R 53102	3.89	3.50
	Cone Steel Cutter	9 R 53103	3.89	3.50
(3)	Oval Steel Cutter	9 R 25014	3.89	3.50
(4)	Circular Steel Cutter	9 R 25016	3.89	3.50
	Cylinder Steel Cutter	9 R 53070	3.89	3.50
	1/4-in. High-speed Cutter	9 R 53069	3.89	3.50
(5)	Tapered Tungsten Carbide Cutter	9 R 53072	5.89	5.30
	Cylinder Tungsten Carbide Cutter	9 R 53071	5.89	5.30
(6)	Pointed Tungsten Carbide Cutter	9 R 53073	5.89	5.30
	Ball Tungsten Carbide Cutter	9 R 53104	5.89	5.30
	Cone Tungsten Carbide Cutter	9 R 53105	5.89	5.30
(7)	Cylinder Structured Tooth Tungsten Carbide Cutter	9 R 53106	9.99	8.99
(9)	Trapezoid Engraver Cutter	9 R 53075	1.69	1.52
	Cylinder Engraver Cutter	9 R 53076	1.69	1.52
	Round Engraver Cutter	9 R 53074	1.69	1.52
(10)	Cylinder Abrasive Point	9 R 25046	1.69	1.52
	1/4-in. Cone Abrasive Point	9 R 25049	1.69	1.52
	1/2-in. Cone Abrasive Point	9 R 25053	1.69	1.52
(12)	1/4-in. Grinding Abrasive Disc	9 R 53077	1.69	1.52
(13)	1/4-in. Wheel Grinder	9 R 25057	1.69	1.52
	1/2-in. Wheel Grinder	9 R 53078	1.69	1.52
	1-in. Wheel Grinder	9 R 25058	1.69	1.52
(14)	Tapered Grinding Point	9 R 53079	1.69	1.52
	Cylinder Grinding Point	9 R 53080	1.69	1.52
	Cone Grinding Point	9 R 25062	1.69	1.52
	Disc Grinding Point	9 R 25063	1.69	1.52
(15)	1/4-in. Straight Router Bit	9 R 53091	4.89	4.40
	1/2-in. Straight Router Bit	9 R 53090	4.89	4.40
	1-in. Straight Router Bit	9 R 53092	4.89	4.40
(16)	Beading Router Bit	9 R 53094	4.89	4.40
(17)	Veining Router Bit	9 R 53095	4.89	4.40
(18)	V-groove Router Bit	9 R 53096	4.89	4.40
(19)	Piloted Beading Router Bit	9 R 53107	4.89	4.40
(20)	Piloted Cove Router Bit	9 R 53108	5.89	5.30
(21)	Piloted Rabbet Router Bit	9 R 53109	5.89	5.30
(22)	Piloted Corner-rounding Router Bit	9 R 53111	5.89	5.30
	10-pc. Router Bit Set incl. all router bits (15 thru 22)	9 R 53098	39.99	
(23)	Cutting Wheel	9 R 25024	3.89	3.50
(24)	Fiberglass Reinforced Cutting Wheel	9 R 53088	4.89	4.40
(25)	Fine Blade Steel Saw	9 R 25026	3.89	3.50
(26)	Sanding Discs	9 R 53084	1.69	1.52
(27)	Drum Sander	9 R 25042	2.39	2.15
	Coarse Sander Bands	9 R 53083	1.69	1.52
	Fine Sander Bands	9 R 25043	1.69	1.52
(28)	Wire Wheel Brush	9 R 25038	1.69	1.52
(29)	Wire Cup Brush	9 R 20539	1.69	1.52
	Bristle Cup Brush	9 R 53086	1.69	1.52
	Bristle Disc Brush	9 R 53085	1.69	1.52
(30)	Wire Straight Brush	9 R 53087	1.69	1.52
(31)	Felt Polishing Tip	9 R 53081	1.69	1.52
(32)	Felt Polishing Wheel	9 R 53082	1.69	1.52
	Mandrel for (31, 32)	9 R 53089	1.69	1.52
(33)	Polishing Compound	9 R 25031	1.69	1.52
(34)	Cloth Polishing Wheel	9 R 25033	1.69	1.52
(35)	Emery Polishing Wheel	9 R 25034	1.69	1.52
	Mandrel for (23, 24, 25, 34, 35)	9 R 25028	1.69	1.52
	1/4-in. Collet for all except 53074, 53075, 53076	9 R 25036	1.69	1.52
	3/32-in. Collet for 53074, 53075, 53076	9 R 25037	1.69	1.52



A Sears Exclusive! Multipurpose CRAFTSMAN Tool Tower is a tool chest, roll-a-way and worktable all in one compact, self-storing unit

Black and Decker Workmate™—portable worktables fold for travel or storage



CRAFTSMAN precision tool worktable sets up easily... folds flat for easy storage

Workmate® accessories

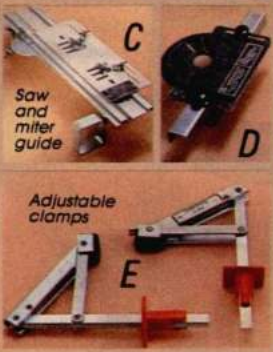

Saw and miter guide

Adjustable clamps

Turn any room in your home into a workshop!

**A** Steel Tool Tower provides 5 sq. ft. storage space and 2.25 sq. ft. work surface. When not in use, just fold down its industrial-grade hardboard top and store it in out-of-the-way corners or closets. Roll-a-way features 6 full-length extension drawers with compound-action slides. Each drawer is 10 3/4-in. front to back, 18-in. wide, 4 drawers are 2-in. deep, 1 is 4-in. deep and 1 is 6-in. deep. Four removable drawer dividers are included. Panel-covered lower compartment is 19x12-in. high, 10 1/4 in. front to back. Overall 12 3/4x49 3/4x40-in. high. External lock bar with padlock eye helps provide security. Top cover has full-length piano hinge with handy information sheet. 9 R 65425N—Shipping weight 85 lbs... **\$139.99**

**D** Router is guided by a fence and securely held with this Workmate® Router Guide. Fits Workmate® centers at left. Works with any router with 6-in. diam. or less base plate with 3 equally-spaced mounting screws not over 3/16-in. diam. Adjustable width, depth. 9 R 65528—Shipping weight 3 lbs. 7 oz... **\$24.99**

**E** Easy to operate Workmate® Clamps secure your workpiece for gluing, sawing, sanding, etc. Fit Workmate® Workbench holes or any flat surface with 1 3/16-in. holes. Rotate 360° and adjust to 3 1/4-in. thickness. Provide 100 lbs. clamping force yet will not mar clamped surfaces. 9 R 65527—Shipping weight 2 lbs... Pair **\$17.99**

**F** Basic table has 23x36x3/4-in. thick hardwood work surface with 2-pc. clamp set, steel legs and 23 1/2x11 1/2-in. pegboard shelf. 30 in. high. 9 R 53058C—Shipping weight 33 lbs... **\$59.99**

**B** Workmate® Work Centers fold compactly enough to fit in most car trunks. Sturdy steel base. Bench top has vise jaws with swivel pegs to hold odd shapes and v-grooves for round stock. Front jaw has built-in 26-in. ruler. Base support has built-in tool holder. Unassembled, instructions incl. Workmate® 400 (shown) has both vertical and horizontal clamping systems. Clamp-down front jaw swings up to provide up to 2 1/4-in. of vertical support for clamping thin stock or work on edges. 29-in. vise jaws open to 8-in. wide. Base shelf holds extra tools. Parts tray is next to front jaw for easy access. Unit measures approx. 31x32x28 in. deep. Folds to just 29x33x9 in. deep. 9 R 65526C—Shipping weight 41 lbs... **\$79.99**

**G** 2-pc. clamp set fits slots on table. 9 R 53057—Shipping weight 1 lb... **\$2.99**

**C** Achieve greater sawing accuracy and safety with this Workmate® Saw and Miter guide. Mounts on Workmate® 400 or 300 centers above. Works with any 7 1/4-in. or smaller circular saw. Meters from 30° to 90° in 5° increments. 9 R 65529L—Shpg. wt. 6 lbs. 13 oz... **\$44.99**

**H** Steel rotary tool holder keeps tool handy yet out of your way until needed. 2 1/2 in. high. 9 R 53056—Shipping weight 12 oz... **\$3.99**

**J** Multi-purpose plastic tool holder keeps pliers, screwdrivers handy. 9 1/2x3 1/2x2 1/4 in. deep. 9 R 53055—Shipping weight 4 oz... **\$2.99**

**K** 4-compartment drawer of molded plastic is 7 1/2x7 1/2x2 1/2 in. deep. Includes mounting hardware. 9 R 53054—Shipping weight 10 oz... **\$3.99**

Deluxe table outfit incl. F, H, J and 2 drawers (K). Separate prices total \$74.95. 9 R 53059C—Shpg. wt. 35 lbs... **\$69.99**

# Available in Catalog only! CRAFTSMAN® Industrial/Commercial Wet/Dry Vac Outfits built tough enough to satisfy the most demanding professionals!

When you have tough cleaning jobs to do, rely on extra-strong suction power to lift heavy, messy debris into large capacity tanks. Strong suction power is generated via a high-efficiency blower wheel and patented air-venting system. Handles wet, dry debris simultaneously. Reusable filters remain in tanks for both wet and dry pick ups.

Automatic shutoff prevents liquid overflows. Polypropylene tanks withstand mildly corrosive liquids. Built-in drain makes liquid removal easier. Cart with accessory tote carries the equipment needed to clean up big, messy spills. Plated, heavy duty accessories let you clean up specific types of spills more efficiently.



Our most powerful 16-gallon commercial Vac Outfit develops a tremendous 2.5 peak HP of suction power! It'll pick up just about anything that will pass thru its hose!

**\$349<sup>99</sup>**

For only \$14 monthly\* our most powerful commercial/ industrial vac gives you more suction power than any other vac on this page. It'll lift virtually any debris from foam packing material and fine sawdust to broken glass and concrete. Turns into a blower also. Incl. 10-ft., 1½-in. diam. crushproof plastic hose and these stainless steel accessories: floor nozzle, 2-pc. extension wand, dusting brush, crevice tool, wet nozzle, carpet nozzle. Also incl. cart with accessory tote. Takes replacement filter 9-17816 sold on p. 120. UL listed AC. 15-ft. cord. Approx. 40x27-in. diam. Warranted by Sears, write for free copy, see p. 148.

9 R 17990N—Shipping weight 72 lbs. . . \$349.99

thru 7 Accessories\*\* include adapters for use with all our wet/dry vacs with 1½-in. diam. hose. Must purchase 9 R 16909 extension hose with adapters to use metal attachments with 2½-in. diam. vacs. Metal constr. except for plastic ext. hose.

Item	Description	Catalog Number	Wt.	Price
(1)	10-ft. Hose with adapters	9 R 16909	4 lbs. 4 oz.	\$16.99
(2)	Crevice Tool	9 R 16904	1 lb. 3 oz.	6.99
(3)	Round Brush	9 R 16905	11 oz.	12.99
(4)	2-pc. Extension Handle (48 in.)	9 R 16903C	3 lbs. 11 oz.	21.99
(5)	Wet Nozzle	9 R 16907	1 lb. 8 oz.	18.99
(6)	Floor Nozzle with brush	9 R 16906	1 lb. 4 oz.	18.99
(7)	Carpet Nozzle	9 R 16908	1 lb. 12 oz.	16.99

8 Vac Accessory tote of polypropylene plastic. 9 R 17815—Shpg. wt. 3 lbs. 11 oz. . . \$11.99

Commercial vac cart\*\* has 10-in. diam. rear, swiveling front wheels. Fits all 16-gallon CRAFTSMAN Wet/Dry vacs, except 9-17845, 9-17847. Tubular steel handle. 9 R 17807C—Shipping weight 26 lbs. . . \$69.99

Industrial quality 3-pc. accessory kit\*\* includes 2-pc. metal extension wand; 10-ft., 1½-in. diam. plastic hose with metal carpet nozzle and adapters to fit 2½ and 1½-in. accessories. 9 R 16911C—Shpg. wt. 8 lbs. 14 oz. . . Kit \$49.99

\*\*Available in Catalog only!

2.25 peak HP, 16-gallon Vac Outfit tackles tough cleanups with ease

**\$299<sup>99</sup>**

For \$13 monthly,\* make big cleaning jobs go faster with this 2.25-peak HP vac outfit. May be used as a blower with the hose in the exhaust port. Makes short work of your cleaning chores by including accessories that make this vac even more versatile. Outfit includes 10-ft., 1½-in. diam. reinforced plastic hose and these stainless steel accessories: floor nozzle, carpet nozzle, 2-pc. extension wand, dust brush, crevice tool, wet nozzle. Wheeled cart with accessory tote. Takes replacement filter no. 9-17816 sold on p. 120. UL listed AC. 15-ft. cord. Approx. 40x27-in. diam. Warranted by Sears, write for free copy, see p. 148.

9 R 17985N—Shipping weight 70 lbs. . . \$299.99

\*See p. 148

2.0 peak HP, 16-gal. Vac Outfit handles everything from sawdust to muddy floors!

**\$249<sup>99</sup>**

Only \$12 monthly.\* When you need more than just a broom to clean up your office, shop or plant, you can rely on this 2.0 peak HP wet/dry vac to get the job done fast. Incl. 7-ft., 2½-in. diam. reinforced plastic hose, general-purpose nozzle, 2-pc. extension wand, car nozzle, crevice tool, wet nozzle, cart with tote. Takes replacement filter no. 9-17816 sold on p. 120. UL listed AC. 15-ft. cord. Approx. 33x22½-in. diam. Warranted by Sears, write for free copy, see p. 148. 9 R 17831C—Shipping weight 30 lbs. . . \$249.99



10-ft. Hose



Wet Nozzle



Floor Nozzle



Crevice Tool



Round Brush



Carpet Nozzle



2-pc. Extension Wand



Accessory Tote

## Heavy-duty Accessories

# Cleanups are a snap with CRAFTSMAN® wet/dry vacs . . . just check the features below and you'll see why

- ✓ Vacs generate powerful suction via a high-efficiency blower motor and patented air venting system
- ✓ Pick up dry debris, wet spills or BOTH AT THE SAME TIME without changing filters

- ✓ Vacuum air flow cuts off automatically during liquid pickups to prevent overflows
- ✓ Most models convert to blowers for loosening dirt from hard to reach crevices or speed drying damp floors

- ✓ Sturdy, rustproof polypropylene tanks have snap-off lids for emptying dry debris, and most models have built-in drains for liquid disposal



4  
Compact 1.5 peak HP, 6-gallon vac is ideal for household cleanup jobs  
**\$46<sup>99</sup>**



3  
Power thru tough cleaning tasks with this 2.25 peak HP, 16-gal. vac  
**\$109<sup>99</sup>**



This 2.5 peak HP, wet/dry vac is our most powerful and convenient ever!  
**\$139<sup>99</sup>**

- ✓ EXCLUSIVE Cord Rewinder retracts power cord slowly to minimize whipping . . . eliminates bothersome cord winding and storage
- ✓ Select the exact amount of suction power needed for the job with the solid-state speed control
- ✓ EXCLUSIVE 2½-inch diameter non-kink hose springs back to normal even after being run over by a car
- ✓ Includes a 5-piece accessory kit that handles just about everything from kitchen spills to muddy floors

For those really big cleaning jobs, you can rely on this 2.5 peak HP, 32-gallon vac to get the job done  
**\$169<sup>99</sup>**



Reach for a CRAFTSMAN wet/dry vac instead of that broom or mop and tackle tough cleanup quickly and easily. Ideal for cleaning everything from sawdust and cake crumbs to draining clogged sinks and cleaning muddy floors. Vacs are double-insulated for safety, grounded receptacles are not required.

Rolls on casters for easy mobility. Includes plastic hose with utility nozzle. (1) incl. 2-pc. extension wand, crevice tool, car nozzle and wet nozzle. Order from chart below. Accessories, replacement filters sold on p. 120. UL listed. See "N" note, p. 148. Warranted by Sears, write for free copy, see p. 148.

## A BUYER'S GUIDE TO CRAFTSMAN® WET/DRY VACS

Key No.	(1)	(not shown)	(2)	(not shown)	(3)	(not shown)	(not shown)	(4)	(not shown)
Peak HP	2.5	2.5	2.5	2.5	2.25	2.5	1.5	1.5	1.25
Capacity	16 gallons	12 gallons	32 gallons	16 gallons	16 gallons	12 gallons	16 gallons	6 gallons	6 gallons
Hose diameter	2½-in.	2½-in.	2½-in.	2½-in.	2½-in.	2½-in.	2½-in.	1¼-in.	1¼-in.
Built-in drain	Yes	Yes	Yes	Yes	Yes	Yes	Yes	No	No
Converts to blower	Yes	Yes	Yes	Yes	Yes	Yes	Yes	No	No
Dimensions (H x diam.)	28x21-in.	26x19-in.	33x26-in.	23x21-in.	27x22-in.	26x19-in.	29x22-in.	23x16-in.	23x16-in.
Cord length	15-ft. retract.	15-ft.	15-ft.	15-ft.	15-ft.	15-ft.	15-ft.	6-ft.	6-ft.
Replacement filter no.	9-17816	9-17816	9-17816	9-17816	9-17816	9-17816	9-17812	9-17810	9-17810
Catalog Number	9 R 17921C	9 R 17946L	9 R 17967N	9 R 17920C	9 R 17808N	9 R 17806N	9 R 17845L	9 R 17941	9 R 17912
Shpg. wt.	31 lbs.	25 lbs.	40 lbs.	26 lbs.	26 lbs.	25 lbs.	25 lbs.	13 lbs.	13 lbs. 11 oz.
Price	\$139.99	\$109.99	\$169.99	\$119.99	\$109.99	\$99.99	\$69.99	\$46.99	\$36.99

Quiet-running 1.1 peak HP wet/dry vac with accessories cleans up just about any mess from kitchen spills to dirty workshop floors



What's portable, powerful, picks up both wet and dry spills and is found only at Sears? CRAFTSMAN® cordless wet/dry vac!

- Our most powerful cordless vac runs up to 15 minutes per charge
- Has double the capacity of our standard cordless vac
- Transparent container shows you how much debris was collected
- Special nozzle design for hard to reach areas
- Includes a squeegee insert for wet pickups... holds up to 8 fl. oz.
- Recharges continuously when not in use

14



Vac accessories



Turbine sander attachment turns vac into a dustless orbital sander



12

Cordless Vac Plus includes crevice tool for cleaning hard-to-reach areas



15



16

Cordless scrubber is ideal for washing cars or floors... use wet or dry

1 Available in Catalog only. Multi-purpose 6 gal. vac makes quick work of messy spills. Includes 1 1/4-in. diam. hose, 2-pc. interlocking extension wand, combination carpet nozzle/floor brush, crevice tool, round brush, drain unstopper and wet nozzle. Warranted by Sears, write for free copy, see p. 148. 9 R 17909C—Shpg. wt. 17 lbs. \$74.99

2 thru 7 Vac accessories of heavy-duty plastic. Wet nozzle (7) has rubber squeegee.

Key No.	Item description	Catalog Number	Wt. lbs. oz.	Price
(2)	2 1/2-in. diam. 6-ft. hose	9 R 17820	2 8	\$10.49
(3)	Crevice tool	9 R 16902	1 1/2	4.69
(4)	Car nozzle	9 R 16978	1 1/2	5.69
(5)	Dusting brush	9 R 16901	1 1/2	4.69
(6)	Dry nozzle	9 R 16925	1 1/2	4.49
(7)	Wet Nozzle	9 R 17817	1 1/2	8.49
...	Utility nozzle	9 R 16922	1 1/2	4.79
(2)	1 1/4-in. diam. 6-ft. hose	9 R 17866	1 8	9.49
(3)	Crevice tool	9 R 17863	1 4	3.79
(4)	Car nozzle	9 R 17868	1 4	3.79
(5)	Dusting brush	9 R 17862	1 6	3.79
(6)	Dry nozzle	9 R 17825	1 1	7.59
(7)	Wet nozzle	9 R 17826	1 1	7.59
...	Utility nozzle	9 R 16921	1 1	3.79

8 3-in-1 nozzle has retractable brush for use on carpeting, bare floors or draperies. Fits 2 1/2-in. or 1 1/4-in. diam. hose. 9 R 16915—Wt. 1 lb. 7 oz. \$9.99

9 2-pc. extension wand. Plastic construction. 1 1/4-in. diam. wand is 38 in. long when assembled; 2 1/2-in. diam. wand is 44 1/4 in. 9 R 17861—1 1/4-in. Wt. 1 lb. \$7.49 9 R 16964—2 1/2-in. Wt. 2 lbs. \$8.49

A Drain unstopper uses vac suction or blower to remove blockages. Fits 1 1/4-in. diam. vac hoses. 9 R 16916—Wt. 3 oz. \$3.79

10 Available only in Catalog. Homecare accessory kit fits all Craftsman vacs except (9-17834) cordless vac. Incl. dual-purpose carpet and bare floor nozzle, upholstery nozzle, drain unstopper, 2-pc. extension wand, 1 1/4-in. diam. hose with 2 1/2-in. diam. hose adapter. 9 R 16912C—Wt. 3 lbs. 4 oz. \$29.99

6-pc. vac accessory kits (not shown) incl. 2-pc. extension wand, crevice tool, wet nozzle, dry nozzle and dusting brush.

Fits diam.	Catalog Number	Shpg. wt. lbs. oz.	Sep. prices	Kit
1 1/4-in.	9 R 17869	2 11	\$30.25	\$25.99
2 1/2-in.	9 R 16919	1 1	34.85	29.99

11 Sander uses vac suction to generate up to 10,000 orbits per minute. Attaches to vac with 2 1/2 or 1 1/4-in. hose connections. Uses std. 1/2-sheet sandpaper. Warranted by Sears, write for free copy, p. 148. 9 R 16913—Wt. 2 lbs. 8 oz. \$37.99

12 Keep all your accessories handy with our vac accessory tote of Permanex® polypropylene. Adjustable strap fits all CRAFTSMAN vacs. 9 R 17814—Wt. 3 lbs. \$11.49

13 Reusable wet/dry cartridge filters of phenolic-impregnated paper. Washable.

For following wet-dry vacs	Catalog Number	Wt. lbs. oz.	Price
9-1782, 9-1786, 9-1796, 9-17904, 9-1797, 9-1798, 9-17988, 9-17878, 9-17992, 9-17993	9 R 17804	2 8	\$9.49
9-1785, 9-1792, 9-1787, 9-1788, 9-1793, 9-17802, 9-17851, 9-17855, 9-17885, 9-17871, 9-17881, 9-17931	9 R 17809	1 11	8.49
9-1778, 9-1779, 9-17908, 9-1781, 9-17803, 9-17979, 9-17983, 9-17984, 9-17986	9 R 17812	14	8.49
9-17914, 9-17915, 9-17806, 9-17808, 9-17917, 9-17916	9 R 17816	1 3	9.49
9-17912, 9-17913	9 R 17810	10	8.49
9-17909	9 R 17910	1	8.99

Cloth filter bag for use with older model vacs 9-17821 and 9-17831. Use with paper filter bag sold below. 9 R 16967—Shpg. wt. 1 oz. \$3.69

Pkg. of 5 paper filter bags for use with cloth filter bag sold above. Shpg. wt. 3 oz. 9 R 16946... Pkg. \$2.69

Heavy-duty 2 1/2-in. diam., 13 1/2-ft. vac hose resists kinking and collapsing. 9 R 17829—Wt. 4 lbs. 8 oz. \$15.99

14 Why resort to awkward mops, brooms and dustpans for messy little spills? CRAFTSMAN cordless vac is the ideal tool for cleaning up small messes inside or out with no cord restrictions. Recharger base holds vac and squeegee... mount on wall or countertops. Reusable, washable filter. Imported. Warranted by Sears, write for free copy, see p. 148. 9 R 17834—Wt. 3 lbs. 12 oz. \$36.99

Replacement filter for (14) above. 9 R 17925—Shpg. wt. 1 oz. \$2.49

15 and 16 These cordless tools recharge continuously when not in use. Wall mountable recharger base. Warranted by Sears, write for free copy, see p. 148.

15 Cordless Vac Plus has longer running time than our standard cordless vac below. Incl. crevice tool. Washable, replaceable filter. 9 R 17833—Wt. 3 lbs. 4 oz. \$34.99

Replacement filter for (15) above. 9 R 17541—Shpg. wt. 13 oz. \$2.49

Standard cordless vac (not shown). 9 R 17832—Wt. 2 lbs. 8 oz. \$24.99

16 Cordless scrubber runs up to 30 min. per charge. Large brush cleans quickly, making it ideal for scrubbing floors or cars. Use wet/dry or with detergents. 9 R 17558—Wt. 3 lbs. 3 oz. \$34.99

Adapter couples two 2 1/2-in. diam. hoses together to form longer hose. 9 R 16917—Shpg. wt. 3 oz. \$3.79

# CRAFTSMAN® Motors set dependability in motion

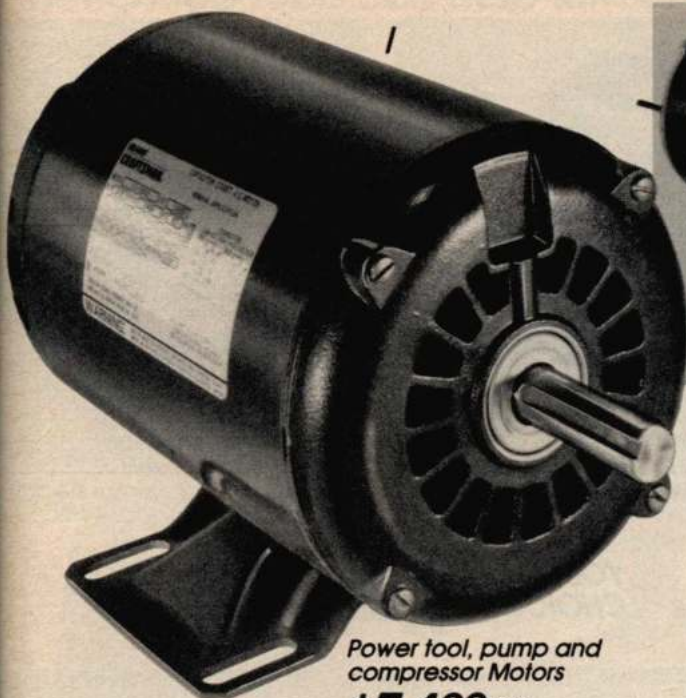

**Power tool, pump and compressor Motors**  
**\$54.99** and up

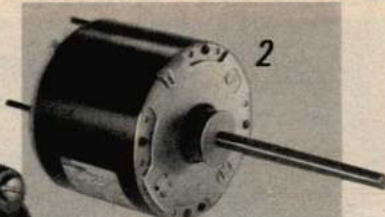

**Motors for outdoor condenser fans and heat pumps**  
**\$59.99** and up

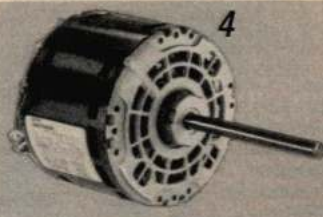

**Direct-drive furnace Motors**  
**\$64.99** and up

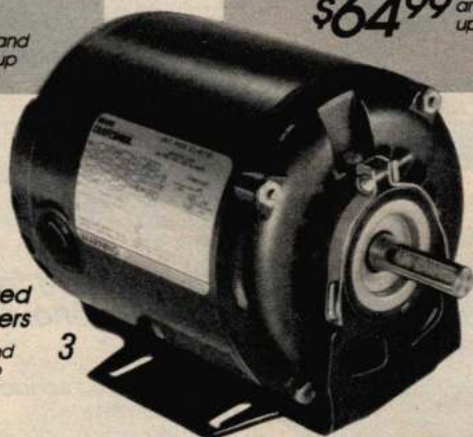

**Motors for belted fans and blowers**  
**\$64.99** and up

Capacitor-start motors for power tools, pumps and compressors reduce starting current and increase torque for hard-to-start loads. Permanently lubricated ball-bearing motors are dual-voltage (115 or 230-v.); have manual reset overload protection to help prevent motor burnouts under heavy loads. Internal circuitry increases reliability and longevity in dusty environments. Sleeve-bearing motors are 115-v. only, do not include dust-resistant circuitry or manual overload protection. Motors are electrically reversible; have rigid, welded 3x4 $\frac{1}{2}$ -in. bases that mount in any position. 4-ft., 3-wire cord. Drip-proof when mounted horizontally. Single-end shaft. No external switches. Customer should provide own inline protection. 60-Hz. AC. Warranted\*.

HP	RPM	Type Bearings	Diam. shaft#	Catalog Number	Wt. lbs.	Price
<b>High-speed capacitor-start motors for table saws, jointer-planers, shapers, sanders.</b>						
1/2	3450	Ball	3/8 in.	9 R 12003C	15	\$94.99
3/4	3450	Ball	1/2 in.	9 R 12004C	17	104.99
1	3450	Ball	5/8 in.	9 R 12005C	19	114.99
1 1/2	3450	Ball	3/4 in.	9 R 12006C	21	124.99
1/2	3450	Sleeve	3/8 in.	9 R 12001C	18	84.99
3/4	3450	Sleeve	1/2 in.	9 R 12007C	17	89.99
1	3450	Sleeve	5/8 in.	9 R 12002C	19	104.99

HP	RPM	Type Bearings	Diam. shaft#	Catalog Number	Wt. lbs.	Price
<b>Low-speed capacitor-start motors for band saws, pumps and compressors.</b>						
1/2	1725	Ball	3/8 in.	9 R 12009C	16	\$99.99
3/4	1725	Ball	1/2 in.	9 R 12013C	22	114.99
1	1725	Ball	5/8 in.	9 R 12015C	28	134.99

HP	RPM	Type Bearings	Diam. shaft#	Catalog Number	Wt. lbs.	Price
<b>Low-speed capacitor-start motors for drill presses and lathes.</b>						
1/2	1725	Sleeve	3/8 in.	9 R 12011C	16	\$94.99
3/4	1725	Sleeve	1/2 in.	9 R 12014C	22	104.99

HP	RPM	Type Bearings	Diam. shaft#	Catalog Number	Wt. lbs.	Price
<b>Low-speed split-phase motors (not capacitor-start) for easy-to-start sanders and band saws have 3/8-in. adapter sleeve, 3/8-in. flat on shaft, except 12039, 3/8-in. keyway.</b>						
1/4	1725	Sleeve	1/2 in.	9 R 12036C	13	\$54.99
1/2	1725	Sleeve	3/4 in.	9 R 12037C	17	59.99
3/4	1725	Sleeve	5/8 in.	9 R 12039C	15	64.99

3/8-in. shafts have 3/8-in. keyway  
 1/2-HP high-speed capacitor-start motor is made for shaper applications. Same as above, except toggle switch reverses motor (motor must come to a complete stop before reversing). Ball bearings. Manual reset overload protection. 115-v. only. 60-Hz. AC.  
 9 R 12008C—Shpg. wt. 18 lbs. . . \$99.99

## Work arbors

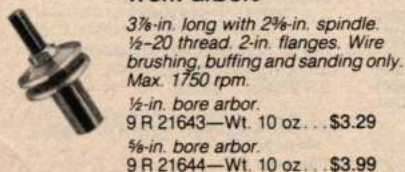

3 3/8-in. long with 2 3/8-in. spindle.  
 1/2-20 thread, 2-in. flanges. Wire brushing, buffing and sanding only. Max. 1750 rpm.  
 1/2-in. bore arbor.  
 9 R 21643—Wt. 10 oz. . . \$3.29  
 3/8-in. bore arbor.  
 9 R 21644—Wt. 10 oz. . . \$3.99

Ideal replacements for outdoor condenser fans and heat pumps, these sleeve-bearing motors are electrically reversible, permanent split capacitor. Totally enclosed for shaft up or shaft down applications. Matching capacitor included. Automatic reset overload protection helps prevent motor burnouts. Drain holes with removable plugs at both ends. 30-in. leads and 1-in. extended studs. 208-230-v. 60-Hz. AC. Warranted\*.

HP	RPM	Shaft diam.	Shaft length	Catalog Number	Wt. lbs.	Price
1/4	1075	1/2 in.	6 in.	9 R 12061	13	\$59.99
1/2	1075	1/2 in.	6 in.	9 R 12062C	16	64.99
3/4	1075	1/2 in.	6 in.	9 R 12063C	17	74.99

## Motors for farm and industrial equipment (not shown)

Reduce starting current and increase torque for hard-to-start loads with these capacitor-start motors. Permanently lubricated ball-bearings. Motors are 115-v. or 230-v. induction-run except 12032-33 are 230-v. capacitor-run. Manual reset overload protection (except as noted) helps prevent motor burnout under heavy loads. Motors are electrically reversible; have rigid welded bases that mount in any position. No external switch or cord. Fan cooled open motors are drip-proof in horizontal position. Totally enclosed fan cooled motors are drip-proof in any position. Single-end shaft. Conduit knock-out for permanent wiring. 60-Hz. AC. NOTE: Sparks not spark-proof. Do not use in situation where sparks could ignite grain, gas, dust, etc. Warranted\*.

HP	RPM	Base mount, in.	Shaft diam. in.	Catalog Number	Wt. lbs.	Price
<b>With open-frame housing</b>						
1	1725	4x5 1/2	3/4	9 R 12023C	33	\$144.99
1 1/2	1725	5x5 1/2	7/8	9 R 12024C	38	164.99
2	1725	5x5 1/2	7/8	9 R 12025C†	45	184.99
2	3450	5x5 1/2	7/8	9 R 12026C†	37	184.99
5	1725	5 1/2 x 7 1/2	1 1/8	9 R 12033N	91	399.99
<b>With totally enclosed extruded aluminum housing.</b>						
1	1725	3x4 1/2	3/8	9 R 12018C	33	\$154.99
1 1/2	1725	4x5 1/2	3/8	9 R 12019C	40	184.99
2	1725	5x5 1/2	7/8	9 R 12021C†	44	204.99
2	3450	5x5 1/2	7/8	9 R 12022C†	38	204.99
5	1725	5 1/2 x 7 1/2	1 1/8	9 R 12032N	91	419.99
<b>With totally enclosed steel housing.</b>						
1/2	1725	3x4 1/2	3/8	9 R 12016C	18	\$104.99
3/4	1725	3x4 1/2	3/8	9 R 12017C	33	114.99

†No overload protection, user must provide in-line protection.  
 Replacement shaft key (not shown). 3/8-in. square. Fits motors with 3/8-in. keyway. Pkg. of 4.  
 9 R 1929—Shpg. wt. 2 oz. . . Pkg. \$1.69  
 \*Warranted by Sears, write for free copy, see p. 148.

Split-phase, sleeve-bearing motors are for belted fans and blowers. Acceptable replacements for motors used in heating, air conditioning and ventilation applications. Automatic reset overload protection helps prevent motor burnouts under heavy loads. Motors are electrically reversible; motors have a conduit knockout and rubber cushion mount to reduce noise and vibration. 12028 is 2-speed. No external switch or cord. Drip proof when mounted horizontally. 12041-42-43 have "L"-shaped slots in base for mounting. Single-end 1/2-in. flatted shaft, 5/8-in. adapter. 60-Hz. AC. Not for power tool applications. Warranted\*.

HP	RPM	Base mount, in.	Shaft diam. in.	Catalog Number	Wt. lbs.	Price
1/4	1725	2 3/4 x 4 1/4	1/2	9 R 12041C	16	\$64.99
1/2	1725	2 3/4 x 4 1/4	1/2	9 R 12042C	19	69.99
3/4	1725	3x4 1/2	5/8	9 R 12029C	20	69.99
1	1140/1725	3x4 1/2	1/2	9 R 12028C	22	79.99
1/2	1725	2 3/4 x 4 1/4	1/2	9 R 12043C	21	79.99

Capacitor-start dual-voltage motors work with hard-to-start belt-driven blowers such as fans, furnaces with central air conditioning. Similar to above, except 3/8-in. square keyway. 115/208-230-v. No switch or cord.  
 1/2 1725 3x4 1/2 5/8 9 R 12027C 22 \$109.99

Electrically reversible, permanent split capacitor, sleeve bearing motors are acceptable replacements for a majority of motors used in gas furnaces and other indoor blower applications. 3 speed selections allow greater flexibility in matching original motor performance. Incl. matching capacitor and 2 1/2-in. diam. rubber cushion mounts. Automatic reset thermal protection helps prevent motor burnout. Fully ventilated; must be mounted in air stream of the furnace. 30-in. leads. 115-v., 60-Hz. AC. Warranted\*.

HP	RPM	Shaft diam.	Shaft length	Catalog Number	Wt. lbs.	Price
1/4	1075	1/2 in.	5 in.	9 R 12051	13	\$64.99
1/2	1075	1/2 in.	5 in.	9 R 12052	14	69.99
3/4	1075	1/2 in.	5 in.	9 R 12053C	17	79.99

## Power tool switch with locking key

Pull-on/push-off. Mounting slots. 6-ft., 3-wire cord. Use grounded power source. Not for equipment rated over 15 amps. Shpg. wt. 1 lb.  
 9 R 13632 . . . \$24.99



Loaded with ideas but lacking space? CRAFTSMAN®



8-inch cast-iron 1/8-HP drill press has 3 speeds for sanding, drilling, buffing and more

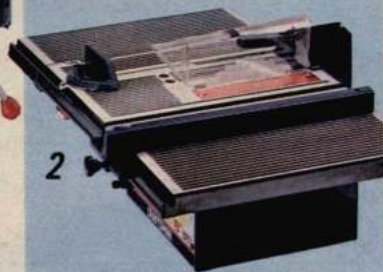

8-inch cast aluminum table saw gives accurate cuts whether you rip, cross cut, miter or bevel



10-inch band saw lets you cut through thick material for resawing



8 1/4-inch chop saw crosscuts, miters and bevels... even through heavy stock

Tools perfect for most household applications

YOUR CHOICE

**\$14.99** \$10 MONTHLY†



1/2-HP Belt/disc sander gives you fine finishing worthy of a professional woodworker

1x42-in. belt sander/6-in. disc sander contours wood, shapes metal, polishes and sharpens tools



16-inch scroll saw does intricate, detailed curve cuts as well as standard cuts



4 1/2-inch jointer-planer gives a smooth, true edge on joints and surfaces... planes rough edges and warped wood

1 Handles most small projects including sanding, buffing, drilling and more. Measures just 7x12x23 1/2 in. Cast-iron head has single-row lower ball-bearing assembly for smooth operation. Cast-iron worktable is 6 1/4 x 6 1/4 in. Base is also cast-iron. Press has 3/8-in. chuck. #33 Jacobs taper type spindle travels up to 2 1/2-in. Incl. removable locking switch key. 6-ft., 3-wire cord. Imported. Warranted\*. Shpg. wt. 44 lbs. 9 R 21372C... \$114.99

2 1/2-HP, induction-run, direct drive motor develops 1-HP. 2 extensions provide a 17x30-in. work surface. Blade tilts for bevel cuts. Rip capacity is 12 3/4 in. right, 13 1/2 in. left. Will cut to 1 3/4 in. thick at 90°, 1 1/2 in. at 45°. Maximum table surface in front of blade at 1-in. cutting depth is 9 in. Outfit includes blade, miter gauge and pickoff type rip fence. Removable locking key switch helps prevent unauthorized use. Warranted\*. Shpg. wt. 47 lbs. 9 R 22161C... \$114.99

3 1/2-HP induction-run motor powers blade to cut wood up to 3-in. thick and 10-in. wide. Table tilts 45° for bevel cuts. Single-knob blade tension adjustment. Cast aluminum frame is approx. 23x13 1/2 x 22 in. high on a cast iron base. Cog-belt-driven mechanism has three 6-in. diam. wheels with rubber tires. Aluminum table measures 11 1/2 x 11 1/2 in. Skip-tooth blade incl. Removable table insert and removable locking switch key. Imported. Warranted\*. Shpg. wt. 45 lbs. 9 R 24451C... \$114.99

4 Direct-drive motor develops 1 1/4-HP to crosscut stock up to 5 1/4 x 2 1/4 in. thick at 90°, miter stock up to 3 3/4 x 2 1/4 in. at 45°, bevel stock up to 5 1/4 x 1 3/4 in. on edge. Aluminum table provides 13 1/4 x 7 1/4 in. work area and has a rotating slot so table never needs replacing. Adjustable work stops. Head remains rigid for precise cuts. Travel lock. Imported. Warranted\*. Shpg. wt. 20 lbs. 9 R 23355C... \$114.99

5 Shape or sand straight edges and contour 8 1/2 x 6 1/4 in. cast aluminum worktable tilts 45° for bevel sanding. 4x36-in. sanding belt travels about 2000 ft. per min. and the cast iron belt table tilts and locks at any angle from 0° to 90°. 6-in. diam. sanding disc rotates at about 3200 rpm. Includes 1 medium grit sanding disc and belt. Removable locking key switch. 6-ft., 3-wire cord. Imported. Warranted\*. Shpg. wt. 50 lbs. 9 R 22642C... \$114.99

6 1/4-HP direct drive motor. 1x42-in. belt assembly has spring tension control. 8x6 3/8-in. belt table adjusts from 90° to 45°. 6-in. aluminum sanding disc. 8 3/4 x 5 1/2 in. disc table includes miter gauge. Removable platen permits contour sanding. Imported. Shipping weight 33 pounds. 9 R 22671C... \$114.99

7 Induction-run, direct drive, ball-bearing motor has speed of 1700 strokes per minute. Cuts to 2 in. deep at 90°, 1 in. deep at 45°, 3/4 in. blade stroke. 8x14 in. cast aluminum table tilts 45° for bevel cuts. Adj. clear plastic guard. Incl. two 5-in. pin-type blades and removable locking switch key. Imported. Warranted\*. Wt. 40 lbs. 9 R 23611C... \$114.99

Pkg. of 5 pin-type jig-saw blades (not shown) for wood, metal. 5-in. long. 15 teeth per inch. Shipping weight 1 ounce. 9 R 26873... Pkg. \$2.19

Pkg. of 5 pin-type jig-saw blades (not shown) for soft wood up to 1/4-in. thick. 5-in. long. 18 teeth per inch. Shipping weight 1 ounce. 9 R 26879... Pkg. \$2.19

8 3/8-HP universal motor powers 2 precision-ground steel knives to make 16,000 cuts per minute. Planes wood up to 4 1/2-in. wide with a maximum cutting capacity of 1/8-in. per pass. Steel fence tilts to let you bevel up to 45° inward or outward. Cast iron base helps eliminate vibration and chatter to cut truer joints and plane smoother surfaces. Cast iron table measures 21 1/2-in. long. Incl. 2 structure foam hold-down push blocks. 6-ft., 3-wire cord. Warranted\*. Shipping weight 39 pounds. 9 R 23622C... \$114.99

Set of 2 replacement knives for (8). Shipping weight 3 ounces. 9 R 22993... \$9.99

\*Warranted by Sears. Write for free copy, see page 148.  
†See page 148.

**Steel leg stand**

9 Heavy-gauge steel leg stand fits 9-22161, 24451, 21372, 22642, 23611 tools on this page. Not Craftsman. Shpg. wt. 15 lbs. 9 R 22244C... \$21.99

9



# bench-top tools can help turn dreams into reality



10-inch 1/8-HP  
band saw/sander  
**\$199<sup>99</sup>**

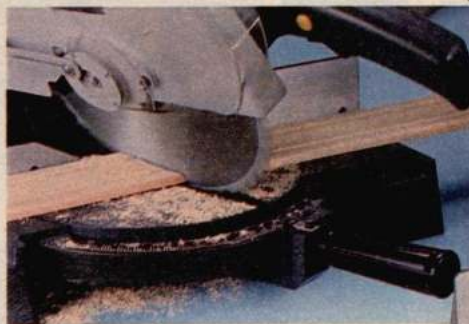

10-inch compound miter saw  
crosscuts, miters and bevels  
even through heavy stock  
**\$219<sup>99</sup>**



7 1/2-in.  
compound  
cut  
radial  
miter saw  
bevels,  
crosscuts  
and  
miters  
accurately



Compact 12-inch wood lathe does  
quality woodturning in less space



1-inch belt sander/  
disc grinder  
**\$199<sup>99</sup>**



10-inch 1/4-HP  
cast-iron  
drill press  
with 4 speeds  
**\$199<sup>99</sup>**

Walking beam scroll saw makes extremely precise cuts  
**\$199<sup>99</sup>**



5



6

**\$249<sup>99</sup>**

1 **\$10 MONTHLY\*** Direct-drive universal motor cuts wood up to 4 in. thick at speeds from 500 to 2000 sawing ft. per min. 7-in. plastic wheels. 14x13-in. cast aluminum table. Miter gauge. Incl. 62 1/2-in. cutting blade. Warranted\*\*. See "N" note, p. 148. 9 R 2442N—Wt. 38 lbs. . . \$199.99

2 **\$11 MONTHLY\*** gets you the only 10-in. miter saw we sell that provides both full bevel and compound cutting features. You can cross-cut and bevel 2x6-in. stock! 2HP max. developed, direct drive motor with an electric brake that brings blade to a quick stop. Miter and bevel cut capacity of 45° right and left with positive stops at 0° and 45°. Also cross cuts at 90°. Sliding 2 1/2-in. fence adjusts for max. support with small and large boards. Cast iron body for stability with a lightweight die-cast aluminum upper guard and clear plastic retracting lower guard for added protection. Warranted\*\*. See "N" note, p. 148. Imported. 9 R 23461N—Wt. 64 lbs. . . \$219.99

Cut-off replacement blade for (2). 10-in. diameter. 44 teeth, 5500 max. RPM, 3/8-in. arbor. 9 R 32039—Wt. 1 lb. 10 oz. . . \$9.99

3 **\$10 MONTHLY\*** 12-in. wood lathe has turning capacity of 12 in. over bed for faceplate turning, 8 in. diam. over tool rest. Tailstock has No. 1 morse taper. 51x10x10 1/2-in. overall. Belt drive and 4-step machine and motor pulleys provide quick speed changes of 875, 1350, 2250 and 3450 RPM. Incl. 12-in. tool rest, spur, cup centers. Key lock switch. 6-ft., 3-wire cord. Warranted\*\*. 9 R 22836C—Wt. 50 lbs. . . \$189.99

4 **\$10 MONTHLY\*** Sand, contour, shape metal, polish and sharpen tools. 1/2 HP maximum capacity, direct drive motor. 1x42-in. belt assembly with spring tension control for quick change of sanding belt. 5x7-in. belt table adjusts from 90° to 45°. 42-in. aluminum oxide belt. 8-in. aluminum sanding disc. Cast-iron 4 1/2x12 1/2-in. disc table includes miter gauge. Built-in "V" belt tension control for easy belt adjustment. Imported. 9 R 22632N—Wt. 64 lbs. . . \$199.99

8-in. aluminum oxide sanding disc assortments for (4). Incl. 2 ea.: fine, medium, and coarse grits. Wt. 10 oz.

Type	Cat. No.	Pkg.
Standard	9 R 22733	\$2.99
Pressure sensitive	9 R 22745	3.99

Package of three 1x42-in. sanding belts

Type	Catalog No.	Shpg. wt.	Pkg.
Fine	9 R 26056	3 oz.	\$4.39
Med.	9 R 26055	4 oz.	4.39
Coarse	9 R 26054	4 oz.	4.39

Aluminum sanding discs for item (9) on p. 623A. 3/8-in. bore with 3/16-in. keyway. 5/8-1/2-in. bushing incl.

Diameter	Catalog No.	Shpg. wt.	Price
8-in.	9 R 25135	1 lb.	\$9.99
9-in.	9 R 25136	1 lb. 8 oz.	12.99

5 **\$10 MONTHLY\*** Using a narrow blade, this saw can cut a pencil line in half! Bevel cuts are easier because blade tilts 45° left or right; table and workpiece stay stationary. 2 intersecting miter slots and miter gauge let you crosscut or use locked miter gauge for a rip guide. 18-in. throat for large pieces. Built-in sawdust blower. Cuts to 2-in. deep at 90°, 1 1/8-in. 45°. 7/8-in. blade stroke. Direct-drive, induction-run motor delivers 1600 strokes per min. Uses 5 to 6-in. plain blades, 5-in. pin type. Includes 3 blades, 2 sets of holders, set screw wrench. Die-cast aluminum worktable is 9x14 1/8-in. 28 3/4x11x12 1/4-in. high overall. 120-v. 60-Hz. AC. 6-ft., 3-wire cord. Warranted\*\*. Wt. 26 lbs. 9 R 2076C . . . \$199.99

6 **\$12 MONTHLY\*** Direct-drive saw has pull-through action for extreme accuracy. Crosscuts stock up to 8 3/4x2 1/8-in. thick at 90°; miters stock up to 6 3/4x2 1/2 in. thick at 45°; bevels stock up to 8 3/4x1 3/4 in. thick at 45°. Quick-release miter lock speeds angle changes with positive stops at 0° and 45° left or right. Steel blades cut through wood, plastics, composition materials. 6x20-in. aluminum table has rotating slot so it never needs replacing. Wrench included. Warranted\*\*. See "N" note, page 148. 9 R 2374N—Wt. 65 lbs. . . \$249.99

7 **\$10 MONTHLY\*** 1/4-HP induction-run motor has 4 speeds from 480 to 3000 rpm. Quick belt tension release for easy speed changes. #33 JT taper chuck. 8x8-in. cast-iron table has rack and pinion elevation adjustment. Speed chart on side of cast-iron head tells you the proper speed for most materials. Imported. Warranted\*\*. 9 R 21383N—Wt. 82 lbs. . . \$199.99

\*See p. 148.  
\*\*Warranted by Sears, see p. 148.

## Table Saw Accessories

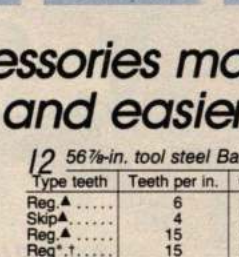

## Bench-top tool accessories make your tools more versatile and easier to use

**1** Dado Set has Kromedge blades with chippers matched for even cuts. Incl. 2 outside 1/8-in. thick cutters; one 1/8-in., two 1/8-in. thick chippers. Cuts to 3/8-in. wide. 5/8-in. arbor.  
9 R 32581—Wt. 2 lbs. 10 oz. . . . Set **\$20.99**

Dado insert for use with Dado Set (1) above.  
9 R 22281—Shpg. wt. 5 oz. . . . **\$8.99**

**2** Molding Insert is required when using molding head.  
9 R 22282—Shpg. wt. 5 oz. . . . **\$8.99**

**3** Molding Head Set makes decorative cuts without using a shaper. Incl. 5/8-in. diam. double cutter head, 3 sets of bits (1-in. planer and jointer; 3/8-in., 1/2-in. qtr. round 1/4 in. bead; 1/4 in. flute and 1/2 in. cove). 5/8-in. arbor, 1/2-in. bushing.  
9 R 3222—Wt. 2 lbs. 8 oz. . . . Set **\$20.99**

**4** 8-in. general-purpose chrome-nickel steel Blade has 12 carbide tips. Maximum 5500 rpm. Standard construction. 5/8-inch arbor, 1/2-inch bushing.  
9 R 32484—Wt. 1 lb. 8 oz. . . . **\$14.99**

**5** 8-in. Kromedge crosscut chrome-nickel steel plywood blade has 100 teeth, 1 1/4 in. depth of cut. Max. 5500 rpm. 5/8 in. arbor; 1/2 in. bushing.  
9 R 32443—Shpg. wt. 14 oz. . . . **\$6.79**

**6 thru 11** Jig saw blades of heat-treated alloy steel. 6-in. plain-end blades snap off to fit saws taking shorter blades. Pkg. of 5. Wt. 1 oz.

Item	Lgth. in.	Width in.	Teeth per in.	Use for	Catalog Number	Per pkg.
------	-----------	-----------	---------------	---------	----------------	----------

Pin-tooth Blades; .020 in. thick						
(6)	3	.065*	25	wood, metal	9 R 26877	<b>\$2.19</b>
	3	.187**	15	wood, fast cut	9 R 26878	<b>2.19</b>
	4	.065*	18	wood, plywood	9 R 26871	<b>1.79</b>
(7)	5	.110	10	wood, metal	9 R 26870	<b>2.19</b>
	5	.110	15	wood, metal	9 R 26873	<b>2.19</b>
	5	.055*	18	soft woods	9 R 26879	<b>2.19</b>
	5	.110	20	soft woods	9 R 26872	<b>2.19</b>
	6	.110	15	wood, metal	9 R 26881	<b>2.19</b>

Plain-end Blades for most jig saws; .020 in. thick						
(8)	6	.110	10	wood rough metal	9 R 26885	<b>\$2.19</b>
	5	.110	15	wood, metal	9 R 26874	<b>2.19</b>
	5	.110	10	wood, metal	9 R 26875	<b>2.19</b>
	5	.110	20	wood, metal	9 R 26876	<b>2.19</b>
	5	.050	15	wood, metal	9 R 26867	<b>2.19</b>
(9)	5	.035	20	wood, metal	9 R 26868	<b>2.19</b>
	5	.250	7	wood, metal	9 R 26869	<b>2.39</b>
	6	.110	15	wood, fine metals	9 R 26883	<b>2.19</b>
(10)	6	.110	20	thin sheet metals, incl. steel	9 R 26884	<b>2.19</b>
	Use with former 9-2072 as sabre saw; .028 in. thick	6	.250	20	wood, metal	9 R 26888
(11)	6	.187	10	wood, soft metal	9 R 26887	<b>2.39</b>

\*.010 in. thick \*\* .015 in. thick

**12** 56 7/8-in. tool steel Band Saw Blade

Type teeth	Teeth per in.	Catalog No.	Wt. oz.	Price
Reg. ▲	6	9 R 26653	2	<b>\$4.99</b>
Skip ▲	4	9 R 26652	2	<b>4.99</b>
Reg. ▲	15	9 R 26651	2	<b>4.99</b>
Reg* .†	15	9 R 26650	1	<b>4.99</b>

▲ 1/4-in. width † 1 1/8-in. width

**13** 15-pc. kit includes 5 sizes of rubber-cushioned, self-expanding drums with metal shanks: 1/2x1/2, 3/4x1, 1x1, 1 1/2x1 1/2, 2x1 1/2 in. You get 1 medium and 1 fine grit sanding sleeve for each. Conveniently stores in solid wood rack.  
9 R 25266—Wt. 2 lbs. 12 oz. . . . Kit **\$19.99**

**14** Sears cloth-backed sanding belts for bench sanders have an aluminum oxide abrasive for use on wood or metal. 4x36 in.

No.	Grit		Catalog Number	Wt. oz.	Price
	type				
100	Fine		9 R 22151	2	<b>\$2.69</b>
80	Med.-fine		9 R 22150	3	<b>2.69</b>
60	Medium		9 R 22152	3	<b>2.69</b>
40	Coarse		9 R 22153	4	<b>2.69</b>

**15** 6-in. Sanding Discs for portable or bench sanders have a pressure sensitive adhesive backing for quick placement and removal of discs. Aluminum oxide abrasive. Pkg. of 6.

No.	Grit		Catalog Number	Wt. oz.	Pkg
	type				
220	Ex. Fine		9 R 25247	1	<b>\$2.99</b>
120	Fine		9 R 25248	1	<b>2.99</b>
80	Med. fine		9 R 25249	2	<b>2.99</b>

**16** CRAFTSMAN Forstner Wood Drill Bit Set lets you drill clean flat bottom holes in wood, veneers and end grains. 1/4-in. long high-speed bits fit 3/8-in. or larger chucks. Includes 3/8, 1/2, 3/4 and 1-in. bits.  
9 R 20975—Wt. 10 oz. . . . Set **\$32.99**

**17** 4-pc. 8-in. table saw Accessory Kit includes protective goggles, 8 in. master combination blade, dado and sanding disc.  
9 R 32071—Wt. 4 lbs. 8 oz. . . . Kit **\$32.99**

**18** 3-in. general-purpose Vise for use with drill presses has jaws that open to 2 1/4 in. Jaw depth is 1 1/8 in.; width 3 1/8 in. Slot-type shoulders allow bolting to worktable (bolts not included). Slide bar and axial sleeve. Includes prismatic jaw. Imported.  
9 R 25272—Wt. 6 lbs. 4 oz. . . . **\$19.99**

**19** Miter Gauge has steel degree indicator. Constructed of die-cast aluminum with a machined head. Will fit most bench-top tools with a 3/8x1/4-in. deep miter groove.  
9 R 24214—Wt. 1 lb. . . . **\$12.99**

**20** This heavy-gauge steel Leg Stand fits all bench-top tools on page 130 except items (4 and 7). Unassembled.  
9 R 22244C—Wt. 15 lbs. . . . **\$21.99**



Maximize your workspace with these convenient Work Stations



**21** Steel Revolving Work Station lets you mount 3 bench-top tools (up to 16 3/4-in. high for full 360° rotation) for use when you need them. 3 industrial-grade hardboard mounting surfaces measure 24x24x3/8-in.; 2 auxiliary work surfaces measure 28x12x3/8-in. Total work area 16.67 sq. ft. Overall 48x28 1/2x33-in. high. Incl. adjustable leveling feet and 2 casters. Unassembled.  
9 R 65511N—Shpg. wt. 115 lbs. . . . **\$129.99**

**22** Stationary work station with 20x32-in. hardboard top that can be used as a work surface or to mount your table-top tools. Incl. 3 pegboard sides and 2 hardboard shelves for additional tool and accessory storage. Overall 32x20x33 1/2-in. H. Unassembled.  
9 R 65511C—Shpg. wt. 36 lbs. . . . **\$49.99**

124 9 R 65511C—Shpg. wt. 36 lbs. . . . **\$49.99**



1 Jointer chip collector

1 For 6½-in. jointers except (4). Steel frame with a heavy duty bag to catch wood chips. Attaches to leg stand (not incl.).  
9 R 29977—Wt. 3 lbs. 8 oz. . . \$39.99

2 Set of 2 structural foam hold-down push blocks has comfortable contoured handles, rubber gripping pads.  
9 R 2299—Wt. 1 lb. 3 oz. . . Set \$11.99



Knife setting gauge set

2 Hold down push blocks

3 Cast-iron knife setting gauge set has micrometer adjustments for accurate installation of cutter knives. Includes blade touch-up stone.  
9 R 2647—Wt. 1 lb. 4 oz. . . Set \$24.99

Package of three 6½-in. precision-ground steel cutting knives (not shown) fit (4) and most other CRAFTSMAN 6½-in. jointer-planers.  
9 R 2293—Wt. 7 oz. . . Pkg. \$17.99

4 Enjoy professional results with this CRAFTSMAN 1½ max. dev. HP jointer-planer. The base, table and fence are made of rugged cast iron for long-lasting performance and accurate cutting time after time. Cutter head moves smoothly on permanently-lubricated ball bearings. Three cutter knives make up to 12,900 cuts per minute, while quick cam-activated levers adjust position of the fence with ease. Fence tilts 45° inward and outward. Depth of cut scale from 0-½ in. Working surface is 36 in. long. Includes sturdy steel leg set with upper and lower stiffeners plus 2 structural foam hold-down push blocks. Unassembled. UL listed. 6-ft. 3-wire cord. Warranted by Sears. Write for free copy, see p. 148.  
9 R 20601N—Wt. 173 lbs. . . \$379.99

Chip collector (not shown) for (4) is similar to (1).  
9 R 29987—Wt. 3 oz. . . \$39.99

5 This CRAFTSMAN belt and chain-drive jointer-planer-molder lets you smooth and square joints to precisely fit, plane rough stock to a smooth, uniform thickness and execute professional-quality molding operations. Joint boards up to 6½ in. wide, up to ¼ in. deep in one pass. Plane wood up to 8 in. wide, and 4½ in. thick, up to ½ in. deep in one pass. Mold up to ¾ in. deep in one pass. Constructed from formed steel. 1-HP motor develops max. 2-HP; spins a double-knife at 6000 rpm. Steel bed is 36½ in. long and has a jointing fence which tilts up to 45° left or right for accurate bevells and chamfers. Power feed guides stock for planing and molding at 28 feet per minute. UL listed. 6-ft., 3-wire cord. Unassembled. Warranted by Sears. Write for free copy, see p. 148.  
9 R 23377N—Wt. 198 lbs. . . \$799.99

High-speed steel replacement knives (not shown). Set of 2.  
9 R 23342—Wt. 6 oz. . . Set \$24.99

## Save 10% when you buy any 3 or more molding cutter bit or knife sets

6 thru 15 These alloy steel knives let you cut simple or elaborate moldings. (6, 7, 9, 13 and 14) include a back relief knife. (8, 10 and 12) are one-knife sets, (11 and 15) are two-knife sets. For (5) and planer-molders sold on page 126.

Molding Knife Type	Catalog Number	Wt. set		Set	Any 3 or more each set
		lbs.	oz.		
(6) Decor casing	9 R 23336	1	4	\$59.99	\$53.99
(7) Fancy casing	9 R 23337	1	3	59.99	53.99
(8) Base shoe	9 R 23331		11	29.99	26.99
(9) Large casing	9 R 23334	1	11	79.99	71.99
(10) Cove	9 R 23333		11	29.99	26.99
(11) Crown	9 R 23341	1	10	119.99	107.99
(12) Stop	9 R 23332		12	34.99	31.49
(13) Base	9 R 23335	1	4	79.99	71.99
(14) Chair rail	9 R 23338	1	7	59.99	53.99
(15) Tongue and groove	9 R 23339	1	11	79.99	71.99

16 thru 27 These alloy steel cutter bits are used to cut a variety of designs on edges and surfaces. All are sets of 3, except (27), set of 6. For (5) and planer molders sold on page 126.

Molding Cutter Type	Catalog Number	Shpg. wt. set		Set	Any 3 or more each set
		wt.	oz.		
(16) Ogee window stop	9 R 23308	2	7.99	\$7.99	\$7.19
(17) Rabbet	9 R 23301	2	7.99	7.99	7.19
(18) Glue joint	9 R 23307	2	7.99	7.99	7.19
(19) 90° flute V-groove	9 R 23309	2	7.99	7.99	7.19
(20) Clover leaf screen mold	9 R 23306	2	7.99	7.99	7.19
(21) ¾ in. qtr. round cove	9 R 23312	2	7.99	7.99	7.19
(22) 1-in. radius flute	9 R 23311	2	7.99	7.99	7.19
(23) ¾-¾ in. qtr. round	9 R 23313	2	7.99	7.99	7.19
(24) ¼-¼ in. qtr. round	9 R 23304	2	7.99	7.99	7.19
(25) 3-bead	9 R 23305	2	7.99	7.99	7.19
(26) Base mold	9 R 23303	2	7.99	7.99	7.19
(27) Tongue and groove	9 R 23302	4	12.99	12.99	11.69

Save \$10.79 when you buy this 12-piece molding cutter bit set. Includes cutter bits (16 thru 27) sold above. Separate prices total \$90.78.  
9 R 2301—Wt. 1 lb. 10 oz. . . \$79.99  
▲ See p. 148

### Molding cutter knife sets

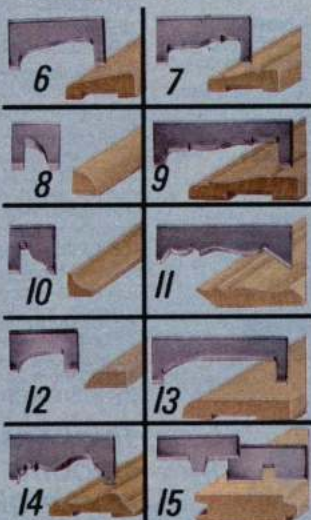

### Molding cutter bits



CRAFTSMAN® 1-HP induction-run jointer-planer handles boards up to 6½-in. wide with up to 12,900 cuts per minute

**\$379.99**  
\$15 MONTHLY▲



CRAFTSMAN® jointer-planer-molder has induction-run maximum developed 2-HP motor

**\$799.99**  
\$27 MONTHLY▲

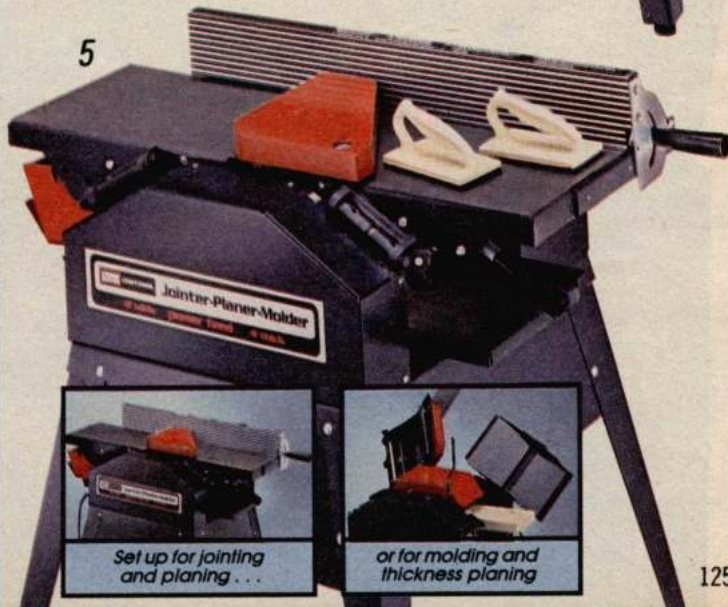

Set up for jointing and planing . . .

or for molding and thickness planing

# CRAFTSMAN® Planer/Molders and Shapers put smooth,



**Thickness Planer Outfit**  
delivers up to 16,000 cuts  
per minute (no load) to  
smooth-finish even rough-cut  
stock up to 10 in. wide  
and 5 in. thick  
**\$489<sup>99</sup>** \$17 MONTHLY\*\*

This compact, portable 10-inch Thickness Planer<sup>▲</sup> has an enclosed universal ball-bearing motor that develops 2-HP. Takes cuts up to 1/32 in. per pass at 26 ft. per min. Height scale has graduations of 1/32-in. increments. Uses a sprocket and chain power-driven roller. Folding roller assemblies incl. blade alignment gauge and adjustment tools. UL listed. 60-Hz. AC. Imported. See "N" note, p. 148.  
9 R 23372C—Shpg. wt. 57 lbs. . . . Outfit **\$489.99**

**1-HP Planer/molder Outfit**  
for most home projects  
**\$649<sup>99</sup>** \$22 MONTHLY\*\*

Built-in high-torque 1-HP motor<sup>▲</sup> provides enough power to let you plane 1/32 inch deep and mold up to 3/4 inch deep per pass. Planes boards up to 8 in. wide and 4 1/2 in. thick. Power feed has non-marring rubber rollers. Hinged side panels for quick access for adjustment and cleaning.  
110-120-v. AC. UL listed.  
9 R 23371N—Shpg. wt. 170 lbs. . . . **\$649.99**

ONE QUALITY NAME  
**CRAFTSMAN**<sup>®</sup>  
OFFERS MORE GOOD CHOICES

3 3/4x42-in. Universal Molding Guide<sup>▲</sup> of high-density hardwood particleboard has adj. steel guides. Attaches to planer bed. Incl. 2 sets of standard guides.

Universal Molding Guide<sup>▲</sup> for 12-in. planer-molder  
9 R 23324C—Shpg. wt. 20 lbs. . . . **\$59.99**

Universal Molding Guide<sup>▲</sup> for 8-in. planer-molder  
9 R 23323C—Shpg. wt. 14 lbs. 4 oz. . . . **\$49.99**

Extra Guides for use in making edge moldings. Set of 4.  
9 R 23326—Shpg. wt. 1 lb. 2 oz. . . . Set **\$14.99**

4 Knife-setting Gauge<sup>▲</sup> eliminates time-consuming planer knife adjustments. Floating pin aligns flush with top of gauge when knives are at the correct height. Adjustable for blades in 12-in. and 8-in. planer-molders. Adjusting block and allen wrench included.  
9 R 23325—Shipping weight 8 oz. . . . **\$14.99**

Set of 3 replacement knives (not shown)  
9 R 4749—Shpg. wt. 1 lb. . . . Set **\$34.99**

5 Support wood for feeding in or out of planer-molder, shaper and any other bench power tool with this Extension Roller and Stand<sup>▲</sup>. Adjusts from 24 to 39 inches. Unassembled.  
9 R 23316C—Shpg. wt. 14 lbs. . . . **\$34.99**



**Thickness Planer/molder Outfit**  
smooths rough stock  
and makes decorative cuts  
on wood up to 12 3/8 in.  
wide, 6 1/4 in. thick . . . gives up  
to 94 cuts per inch  
**\$1249<sup>99</sup>** \$42 MONTHLY\*\*

6 Planer-Molder<sup>®</sup> has enclosed permanently lubricated, ball-bearing 2-HP motor that spins at 3450 rpm to plane 3/16 in. deep and mold up to 3/4 in. deep per pass. Three-knife ball-bearing cutter head constr. Automatic power feed has non-marring rubber rollers. 27 1/4x12 3/8-in. cast-iron bed. Interlocking hood switch automatically shuts off motor if hood is lifted. Steel stand has integral starter with overload protection, safety switch, pulley, drive belts. 230-v., pre-wiring for easy hook-up to motor. UL listed. 60-Hz. AC. Wt. 303 lbs.  
9 R 23362N . . . Outfit **\$1249.99**

Similar outfit\* as above with 5-HP motor, 230-v. Shpg. wt. 356 lbs.  
9 R 23365N . . . Outfit **\$1399.99**

7 Caster set includes 2 front swivel casters with foot-operated lever for adjusting height and 2 non-swivel rear casters. Supports up to 400 lbs. Fits item (8) sold on opposite page. Pkg. of 4. Wt. ea. 6 lbs.  
9 R 22221—Pkg. **\$44.99**  
Any 2 or more pkgs.; ea. **\$38.24**

\*Warranted by Sears. Write for free copy, see p. 148.  
▲Available in Catalog Only!  
\*\*See page 148



# professional finishes on your woodworking projects



Sand surfaces with 6x48-in. belt, removable backstop for long pieces  
Sand inside curves on 3-in. belt-disc idler drum  
Table locks in vertical position to finish ends of long boards



9 ¾-HP belt-disc sander\* has over 100 sq. in. of sanding surface for sanding and finishing most straight and curved surfaces. Cast iron platen tilts and locks in horizontal and vertical positions. Belt travels approx. 2700 ft. per min. 9-in. disc rotates approx. 3450 rpm. Removable 6¼x12-in. cast aluminum table has ¾x¾-in. groove for miter gauge. Incl. steel stand, med. grit sanding disc and a guard with 2½-in. diam. coupling for use with vac. Capacitor-start induction-run belt-drive motor. 6-ft., 3-wire cord. Unassem. 9 R 22593N—Wt. 133 lbs . . . \$379.99

## Need an easy way to put ornamental edges and joints on large pieces of wood? Choose our CRAFTSMAN® high-speed woodshaper with large 27x19-inch cast iron table

8 \$14 MONTHLY, see p. 148. shaper\* lets you scallop, rabbet, contour and mold so smoothly that almost no sanding is needed. Powered by a ½-HP induction-run motor that has built-in reversing switch, shaper turns cutter head approximately 9000 rpm for smooth decorative cuts as you shape and contour-mold wood. Cutter guard attaches behind table for inside and contour shaping. Individually adjustable half-fences. Spindle height adjusts ¾-in. to accept cutters sold separately below.

Table has groove for miter gauge and hold-down clamp sold separately. Steel legs have rubber-padded leveling feet. Outfit includes motor and lockable switch. 120-v., 60-Hz. AC. UL listed. 9 R 23939N—Shpg. wt. 141 lbs . . . Outfit \$349.99  
5-pc. shaper collar set fits ½-in. spindle for bearing surface above or below cutter for part not being shaped. Use with shaper-cutters (10 thru 24), former shaper-cutters (9-2393), (9-2394). 9 R 23672—Shpg. wt. 5 oz . . . Set \$8.49  
\*Warranted by Sears. Write for free copy, see page 148.

**\$349<sup>99</sup>**



Wood shaper incl. cutter guard for inside and contour shaping

## These bit sets will help you use your shaper to make intricate, decorative cuts

### Long-lasting high-speed steel shaper-cutters

10 thru 24 ½-in. bore, 2-in. diam. except (14) and (23) have 2½ in. diam. All are 1 in. high except (17) is ½ in. high and (19) is ¼ in. high.

Type Shaper-Cutter	Cat. No.	Wt.	Each
(10) Lip Cupboard Door or ¾-in. Quarter-round	9 R 3011	4 oz.	\$11.99
(11) 1-inch Jointer	9 R 3012	3 oz.	11.99
(12) 3-bead, ¾-in. Molding	9 R 3013	3 oz.	11.99
(13) ½-in. radius Base Shoe	9 R 3014	3 oz.	11.99
(14) Molding or ½-in. ¼-round	9 R 3015	3 oz.	11.99
(15) 2½-in. diam. ¼ in. Ogee	9 R 3016	3 oz.	11.99
(16) ½ and ¼-in. radius Ease Edge or ¼-in. Glass Bead	9 R 3017	3 oz.	11.99
(17) Drop Leaf Cove	9 R 3018	2 oz.	11.99
(18) ½-in. Groove	9 R 3019	3 oz.	11.99
(19) Reversible Glue Joint	9 R 3020	1 oz.	11.99
(20) ¼-in. Groove	9 R 3021	3 oz.	11.99
(21) Taper Edge	9 R 3022	3 oz.	11.99
(22) Drop Leaf Bead	9 R 3023	3 oz.	11.99
(23) ½-in. Ease Edge or Screen Molding	9 R 3024	3 oz.	11.99
(24) 2½-in. diam., ¼-in. Quarter-round	9 R 3024	3 oz.	11.99
(24) ¼-in. Tongue and Groove Set	9 R 3025	5 oz.	21.99

Save \$24.86 on 15-pc. Set of shaper cutters incl. (10 thru 24). Separate prices total \$189.85. 9 R 30135—Shpg. wt. 2 lbs. 12 oz . . . Set \$164.99

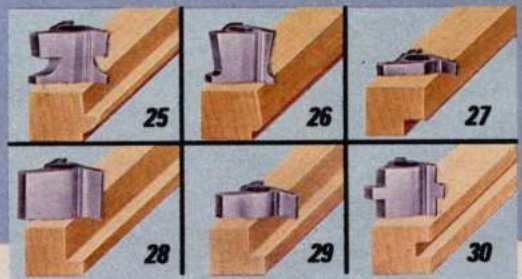
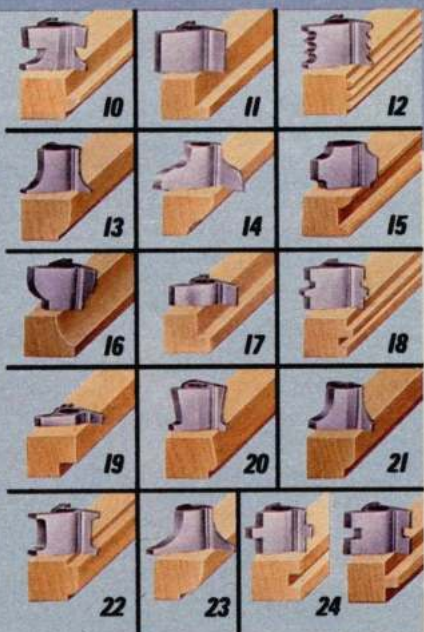

### Tungsten carbide-tipped shaper-cutters cobalt-bonded to steel to last 15 times longer than ordinary shaper-cutters

25 thru 30 ½-in. bore, 2-in. diameter. All are 1 in. high except (27) is ¼ in. high and (29) is ½ in. high.

Shaper-Cutter Type	Cat. No.	Wt.	Each
(25) Lip Cupboard Door, ¼-in., ¼ Round	9 R 3041	4 oz.	\$54.99
(26) Taper Edge	9 R 3043	4 oz.	54.99
(27) ¼-in. Groove	9 R 3045	2 oz.	39.99
(28) 1-in. Jointer	9 R 3042	4 oz.	49.99
(29) ½-in. Groove	9 R 3044	2 oz.	44.99
(30) ¼-in. Tongue and Groove Set	9 R 3046	8 oz.	109.99

Save \$54.95 when you buy 6-pc. set, includes (25 thru 30) above. Separate prices total \$354.94. 9 R 3047—Shpg. wt. 1 lb. 12 oz . . . Set \$299.99

# CRAFTSMAN...the name to trust for Drill Press Outfits

ONE QUALITY NAME

**CRAFTSMAN**

OFFERS MORE GOOD CHOICES

**17 INCH  
16 SPEED 3/4 H.P.**

Our most powerful  
and versatile  
CRAFTSMAN  
heavy-duty  
Drill Press Outfit  
boasts 16 speeds  
and a hefty  
3/4-HP motor!

Look at these features and you'll  
see why we sell more Bench Power  
Tools than anyone else in America!

- Extra-large 14x14-inch cast-iron table swivels, tilts 45° for accurate drilling at almost any angle, has trough with drain hole for recirculating liquid coolants... slots and clamping ledge
- Rack-and-pinion table elevation allows easy, vertical movements and positive lock
- Sturdy cast-iron construction gives added stability and long life
- Built-in light socket with separate switch aids in work set-up

**\$529<sup>99</sup>** \$18 MONTHLY\*

SWIVEL-TILT TABLE

Need new drill bits? look on pages 100 and 101 for a selection of the best drill bits we've ever offered. These titanium nitride-coated drill bits last 7 times longer than our high-speed drill bits!

CRAFTSMAN 15-inch,  
12-speed, 1/2-HP Drill Press  
**\$429<sup>99</sup>** \$16 MONTHLY\*



CRAFTSMAN®  
13-inch,  
5-speed  
1/2-HP  
drill press  
**\$279<sup>99</sup>**  
\$12 MONTHLY\*



Get to the heart of the matter in quick time with this 16-speed Drill Press that drills to the center of a 17-in. workpiece. Helpful chart shows the correct speed for drilling different materials. One-handle belt tension control gives you quick and easy speed changes. Sturdy cast-iron head, table and base. Safety key lock, switch, key. Include 5/8-in. chuck. Mortising Kit sold on opposite page. Order other drill bits from pages 99 and 100. 6-ft., 3-wire cord. Imported. Warranted by Sears, write for free copy, see page 148. Shipping weight 176 lbs. 9 R 21387N . . . **\$529.99**

2 and 3 Our Drill Presses drill holes with utmost accuracy. You control the speed to suit the bit and material. Cast-iron head. Side-mounted information chart shows the correct speed for drilling various materials. Cast-iron worktable has cross slots and clamping ledge. Cast-iron base. Switch with removable locking key. Drill bits not incl., sold on pages 99 and 100. 120-v., 60-Hz. AC. Warranted by Sears, write for free copy, see page 148.

2 This Drill Press drills to the center of a 15-inch workpiece. 5/8-inch chuck, 12x12-inch worktable swivels and tilts 45° for bevel drilling. Built-in light socket has separate switch to aid in work set-up. Imported. Shpg. wt. 167 lbs. 9 R 21385N . . . **\$429.99**

3 Drill Press drills to the center of a 13-inch workpiece. 1/2-inch chuck 10x10-inch worktable tilts 45° for bevel drilling. Imported. Shipping weight 157 pounds. 9 R 21384N . . . **\$279.99**

\*See page 148.





Drill Press Milling Table



18-pc. steel tool Clamping Kit

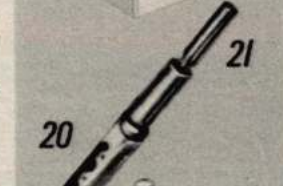
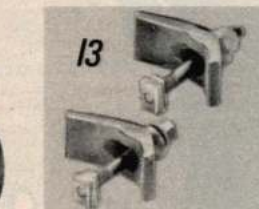
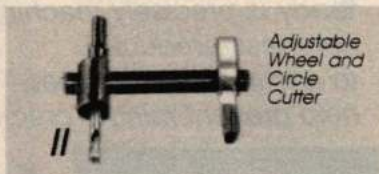
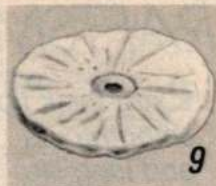
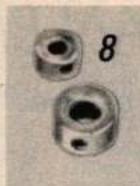

## Drill press Accessories

**1** Drill Press Milling Table. 18"x6-in. wide table has 2 "T" slots. 2 3/8-in. center to center horizontal movement; 13 1/4"x7 1/2-in. longitudinal movement. Use with (2). 9 R 27593C—Wt. 50 lbs. . . . **\$169.99**

**2** 18-pc. steel tool Clamping Kit secures large objects to work tables. Includes 2 each 3x1/2-in., 4x1/2-in., 5x1/2-in. studs, "T" slot nuts, ball joint 4-in. clamps, coupling nuts, "V" blocks, locking stirrups and flange nuts. 9 R 25269—Wt. 12 lbs. . . . **Kit \$59.99**

**3** 2-flute M-7 End Mills. 3/8-inch shank. Shpg. wt. ea. 1 oz.

Size	Lgth/cut	Catalog No.	Price
1/8-in.	3/8-in.	9 R 20609	<b>\$14.99</b>
3/16-in.	1/2-in.	9 R 20611	<b>14.99</b>
1/4-in.	3/4-in.	9 R 20612	<b>14.99</b>
5/16-in.	3/4-in.	9 R 20613	<b>14.99</b>
3/8-in.	3/4-in.	9 R 20614	<b>14.99</b>

Set includes all of (3) above. Wt. 5 oz. Sep. prices total \$74.95. 9 R 20615 . . . **Set \$59.99**

**4** 4-flute M-7 End Mills. 3/8-inch shank. Shpg. wt. ea. 1 oz.

Size	Length/cut	Catalog No.	Price
1/8-in.	3/8-in.	9 R 20603	<b>\$14.99</b>
3/16-in.	1/2-in.	9 R 20604	<b>14.99</b>
1/4-in.	3/4-in.	9 R 20605	<b>14.99</b>
5/16-in.	3/4-in.	9 R 20606	<b>14.99</b>
3/8-in.	3/4-in.	9 R 20607	<b>14.99</b>

Set includes all of (4) above. Wt. 5 oz. Sep. prices total \$74.95. 9 R 20608 . . . **Set \$59.99**

**5** Three-inch Drum Sander with 3/8-in. shank. Abrasive sleeve medium grit No. 80. Expandable drum secures abrasive sleeves without adhesives. 3x3 inches high. 9 R 25244—Wt. 1 lb. 8 oz. . . . **\$14.99**

**3x3-inch aluminum oxide Abrasive Sleeve** assortment for (5) includes 4 fine grit No. 120, 4 medium No. 80, 2 coarse No. 50. Resin bonded to cloth back. 9 R 25245—Wt. 1 lb. . . . **Set \$10.99**

**6** 2 1/4-inch Sanding Drum. 3-inch face. Med. grit sleeves on expandable rubber drum. For 1/4-20 threads. 9 R 25246—Wt. 15 oz. . . . **\$8.99**

**Sanding Drums** (not shown). 1-in. face. Use with safelock or collet chuck, 1/4-in. plain spindle. 1 1/2 in. long.

1 1/2-in. diameter. 9 R 2497—Shpg. wt. 4 oz. . . . **\$5.49**

2-inch diameter. 9 R 2498—Shpg. wt. 5 oz. . . . **\$6.99**

**Sanding sleeves for drums sold above.**

Fine (100 grit) for drum 9-2497. 1 1/2x1-in. diameter. Pkg. of 6. 9 R 24421—Wt. 1 oz. . . . **\$2.49**

Medium (60 grit) for drum 9-2497. 1 1/2x1-in. diameter. Pkg. of 6. 9 R 24422—Wt. 1 oz. . . . **\$2.49**

Coarse (40 grit) for drum 9-2497. 1 1/2x2-in. diameter. Pkg. of 6. 9 R 24423—Wt. 1 oz. . . . **\$2.49**

Medium (100 grit) for drum 9-2498. 2 1/4x1-in. diameter. Pkg. of 6. 9 R 24425—Wt. 3 oz. . . . **\$2.49**

**7** 15-pc. Sanding Drum Kit includes 5 sizes of rubber-cushioned, self-expanding drums with metal shanks: 1/2x1/2, 3/4x1, 1x1, 1 1/2x1 1/2, 2x1 1/2 in. You get 1 med. and 1 fine grit sanding sleeve for each. Conveniently stores in solid wood rack. Shipping weight 2 pounds 12 ounces. 9 R 25268 . . . **Kit \$19.99**

Pkg. of 25 extra sleeves for (7). 10 ea. of fine, med.; 5 for coarse.

Size (in.)	Catalog No.	Wt.(oz.)	Pkg.
1/2x1/2	9 R 25277	1	<b>\$4.99</b>
3/4x1	9 R 25278	3	<b>5.49</b>
1x1	9 R 25279	3	<b>6.99</b>
1 1/2x1 1/2	9 R 25280	8	<b>9.99</b>
2x1 1/2	9 R 25281	11	<b>10.99</b>

**8** Five-piece Stop Collar Set. Fits 1/4, 5/16, 3/8, 7/16, 1/2-inch bits. Shipping weight 3 oz. 9 R 67063 . . . **Set \$9.99**

**9** Eight-inch diameter Buffing Wheel. 3/8-inch arbor. 9 R 6941—Wt. 6 oz. . . . **\$3.79**

Work arbor (not shown) for buffing wheels, sanding drums. For 1/2-20 thread ends. Shipping weight 5 oz. 9 R 24645 . . . **\$10.99**

**10** CRAFTSMAN® Rotary Planer replaces chuck to surface plane 2 1/4 in. wide. Fits former drill presses 9-21378, 9-2131 and most drill presses with #33 Jacobs taper, 1 1/16-20 threaded locking collar. Shipping weight 11 oz. 9 R 2745 . . . **\$29.99**

**11** Adjustable Wheel and Circle Cutter cuts wheels, dial faces, holes in wood, aluminum, copper, plastic. The capacity is 1 to 6-in. diam., and it has a 3/8-in. round shank for drill press use. 9 R 64140—Wt. 3 oz. . . . **\$14.99**

**1/4-inch shank** (not shown) cuts 7/8 to 4-inch diameter. 9 R 3645—Wt. 4 oz. . . . **\$8.49**

**12** CRAFTSMAN 4-piece Forstner Wood Drill Bit Set. 4 1/4-inch long bits fit 3/8-inch or larger chuck. Includes 5/8, 3/4, 7/8 and 1-inch bits. 9 R 20975—Wt. 10 oz. . . . **Set \$32.99**

**13** U-bolt Clamp Set with "T" nuts. For "T" slotted drill press table 9-21387 and for all open-slotted drill press tables. Imported. Shipping weight 4 lbs. 9 R 25134 . . . **Set \$22.99**

**14** 2 1/2-inch Angle Vise with tension design adjusts from horizontal to 90° vertical position. Opens to 2 3/8-in. Slotted-type shoulders for bolting to table (bolts not included). Imported. 9 R 25264—Wt. 9 lbs. . . . **\$34.99**

**3 1/2-inch Angle Vise** as (14) except jaws open to 3 3/8 in. Jaw depth 1 1/2 in.; width 3 1/2 inches. Wt. 9 lbs. 9 R 25265 . . . **\$39.99**

**15** Four-inch General Purpose Vise. Jaws open to 3 3/4 in. Jaw depth 1 3/8 in.; jaw width 4 1/8 in. Slot-type shoulders for bolting to table (bolts not incl.). Slide bar and axial sleeve. Prismatic jaw included. Imported. Shpg. wt. 8 lbs. 12 oz. 9 R 25273 . . . **\$29.99**

**5-in. Vise** as (15) but jaws open to 4 3/8-in. Jaw depth 1 3/8-in., width 5 in. 9 R 25152—Wt. 12 lbs. 12 oz. . . . **\$34.99**

**3-in. Vise** as (15) but jaws open to 2 3/8-in. Jaw depth 1 1/8-in., width 3 1/8-in. 9 R 25272—Wt. 6 lbs. 4 oz. . . . **\$19.99**

**16** 2 1/4-in. Vertical/Horizontal Machinists' Vise. 1 1/2-in. wide jaws open to 2-in. max., 1 1/8-in. depth. For (2), (13). Imported. 9 R 25157—Wt. 5 lbs. 8 oz. . . . **\$24.99**

**17** Quick grip/release Vise and prismatic jaw secures irreg. cylindrical shapes. Slotted shoulders. Imported.

**3-in. size.** Opens to 2 3/4-in. 9 R 25267—Wt. 6 lbs. . . . **\$29.99**

**4-in. size.** Opens to 3 1/8 inches. 9 R 25268—Wt. 9 lbs. 2 oz. . . . **\$34.99**

**18** Cast-iron Cross Vise. 3-in. Jaw opens to 2 3/4-in.; 3-in. wide; 1 1/8-in. deep. 3-in. cross, 5-in. longitudinal travel. Imported. 9 R 25274C—Wt. 15 lbs. . . . **\$64.99**

**4-inch Vise** jaw opens to 3 3/4 inches, 4 inches wide, 1 1/8 inches deep, 4-inch cross and 6-inch longitudinal travel. Prismatic jaw included. Imported. 9 R 25275C—Wt. 21 lbs. . . . **\$74.99**

**5-inch Vise** jaw opens to 4 3/4 inches wide, 1 1/8 inches deep, 5-inch cross and 7-inch longitudinal travel. Prismatic jaw included. Imported. 9 R 25276C—Wt. 31 lbs. . . . **\$89.99**

**19** Mortising Chisel housing for 9-21384, 9-21385. Wood case incl. Imported. 9 R 24655—Wt. 5 lbs. . . . **\$29.99**

**Holding Collet Chuck** (not shown) fits #33 Jacobs taper. For end mills and wood bits with 1/4, 3/8, 1/2-inch shank. 9 R 24672—Wt. 10 oz. . . . **\$15.99**

**20 and 21** Bits for former 9-2464. Not for use with 9-21381. Cut depth 1 7/8 inches. Wt. 2 oz.

Size (in.)	Catalog No.	Each
(20) Mortising Chisels		
3/4	9 R 24206	<b>\$19.49</b>
1/2	9 R 24207	<b>19.49</b>
3/8	9 R 24208	<b>19.99</b>
(21) Mortising Bits		
1/4	9 R 24224	<b>\$11.99</b>
3/8	9 R 24225	<b>11.99</b>
1/2	9 R 24226	<b>12.99</b>

**22** Drill Press Mortising Kit for square holes and slots. Fits 3/8-in. or larger chuck cap. Set includes 3/8-in. Forstner bit, 3/8-in. sq. chisel, die-cast fence, hold-down attachment, fence mounting hardware and instructions. 9 R 29506—Wt. 1 lb. 8 oz. . . . **Kit \$19.99**

**Forstner Bit Squaring Chisel** for (22). Shipping weight 2 ounces.

Size	Catalog No.	Wt. oz.	Price
1/4 in. . . .	9 R 25214	2	<b>\$9.99</b>
3/8 in. . . .	9 R 25215	3	<b>9.99</b>
1/2 in. . . .	9 R 25216	3	<b>9.99</b>

# Our Finest CRAFTSMAN Blades and Dados



Each blade uses only the finest quality C-4 carbide

Extra-thick tips provide smooth cuts and long life

Body is precisely machined, not mass-produced, to assure exact tip-seat, help prevent minute cracks

Each tooth is brazed and impact-tested

Proud American workmen build all Excalibur blades and dados to the highest industrial quality



ONE QUALITY NAME  
**CRAFTSMAN**  
OFFERS MORE GOOD CHOICES

CRAFTSMAN Industrial-quality Carbide-tipped blades

Save \$30 when you buy 3-piece set

\$139.97 \$10 MONTHLY\*

1 thru 3 To really "cut it" with tough-working jobs you need fine industrial-quality blades. Made of heat-treated steel for super-hard and smooth surfaces. These 10-inch blades resist gumming, burning and dulling to a much greater degree than ordinary steel blades. Fit saws with 5/8-inch arbor. Maximum 5500 rpm.

1 60-tooth crosscut.  
Shipping weight 2 lbs. 8 oz.  
9 R 32033 . . . \$59.99

2 24-tooth rip.  
Shipping weight 2 lbs. 6 oz.  
9 R 32031 . . . \$49.99

3 50-tooth Master Combination.  
Shipping weight 2 lbs. 6 oz.  
9 R 32035 . . . \$59.99

Three-piece Saw Blade set. Separate prices total \$169.97. Wt. 7 lbs. 4 oz.  
9 R 32030 . . . Set \$139.97

Our exclusive CRAFTSMAN Carbide-tipped twin-blade Dado adjusts easily and gives you all the smoothness and accuracy of a conventional dado \$89.99

4 For high-quality performance under demanding conditions, tips are cobalt-bonded and impact-tested for outstanding strength. They are also diamond-ground to form a keen cutting edge and chrome-coated to resist rust and help prevent gum and pitch build-up. 48 carbide-tipped teeth last 10 times longer than ordinary steel dados. Quick-adjust collar permits changing of dado widths without removing entire unit from saw arbor. Large 8-inch diameter provides greater depth-of-cut than most other dados. 5/8-inch arbor. Infinitely adjustable dial for widths from 1/4 to 1 3/16 in. Easy-to-read scales for use with table or radial saws. 9 R 32708—Shipping weight 3 lbs. 6 oz. . . \$89.99 \*See page 148.



Twin-blade design helps reduce vibration for clean, square-bottom cuts and flatter, truer grooves

Advanced twin-blade design helps assure positive alignment with cutting

Infinitely adjustable dial for widths from 1/4 to 1 3/16 in. Easy-to-read scales for use with table or radial saws

Easy-to-read scale for fast, convenient depth-of-cut settings

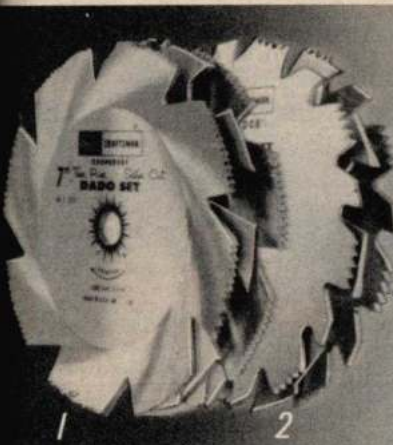

**CRAFTSMAN Dado Sets** feature **KROMEDGE** steel blades for added strength and accurate cuts **\$27<sup>99</sup>** and up

**1 and 2** Blades are heat-treated for strength and fortified with chromium to resist rust. Precision-ground. Set includes two 1/8-inch thick outside cutters, four 1/8-inch thick chippers, one 1/8-inch chipper. Add or remove chippers for maximum variation. See note below, right.

**1** Smooth-cut Dado Set lets you cut sensitive material. Cutters are taper-ground for proper alignment. Cuts up to 1 1/4 inches deep, 1 3/8 inch wide. Fits 5/8-inch arbor.  
7-in. set. Wt. 4 lbs. 12 oz. 8-in. set. Wt. 5 lbs. 6 oz.  
9 R 3257 . . . Set **\$37.99** 9 R 3253 . . . Set **\$44.99**

**2** Standard-cut 8-inch Dado Set for extra-tough jobs. Suitable for normal cuts in framing, construction. Depth of cut varies by machine. Maximum width 1 3/8 inch. Fits 5/8-inch arbor.  
9 R 32475—Shipping weight 5 lbs. 6 oz. . . Set **\$34.99**  
6-inch Dado Set (not shown) is like (2) above but also includes paper washers and instruction booklet. Maximum width 1 3/8 inch. Fits 5/8-inch arbor.  
9 R 3249—Shipping weight 3 lbs. 6 oz. . . Set **\$27.99**

**3 thru 5** These **Adjustable Dadoes** let you plough, groove, trough, slot, rabbet, chamfer, crosscut and more. Adjustable hub lets you easily change width without removing dado. Dial widths from 3/8 inch to 1 3/8 inch. Maximum depth 1 1/2 inches. Use on all woods, laminates, and sensitive materials. Use on 9, 10, 12 or 14-inch table or radial saws only; not for radial saws with universal motor. Single 7-inch blade has carbide-tipped teeth that are individually brazed onto blade, then diamond-ground for smooth cuts, 3/4-inch arbor, 5/8-inch bushings. See NOTE below.

**3** 32-tooth Adjustable Dado. Shpg. wt. 2 lbs. 14 oz.  
9 R 3262 . . . **\$47.99**

**4** 16-tooth Adjustable Dado. Shpg. wt. 2 lbs. 8 oz.  
9 R 3263 . . . **\$32.99**

**5** 24-tooth Adjustable Dado. Shpg. wt. 2 lbs. 14 oz.  
9 R 3261 . . . **\$42.99**

**6** Cut sensitive material with little splintering. Produces professional-looking, extra-smooth cuts. 8-inch Kromedge steel blades have 22 teeth and 5 chippers, all carbide-tipped. Includes two 1/8-inch thick outside cutters, four 1/8-inch thick chippers, one 1/8-inch chipper. Add or remove chippers for maximum variation. Cuts 1/8-1 3/8 inches wide. Fits 5/8-inch arbor. Washers are included. See NOTE below.  
9 R 3264—Wt. 6 lbs. Set **\$79.99**

**NOTE:** Use with radial saw guards sold on page 138 or table saw inserts sold on page 137.

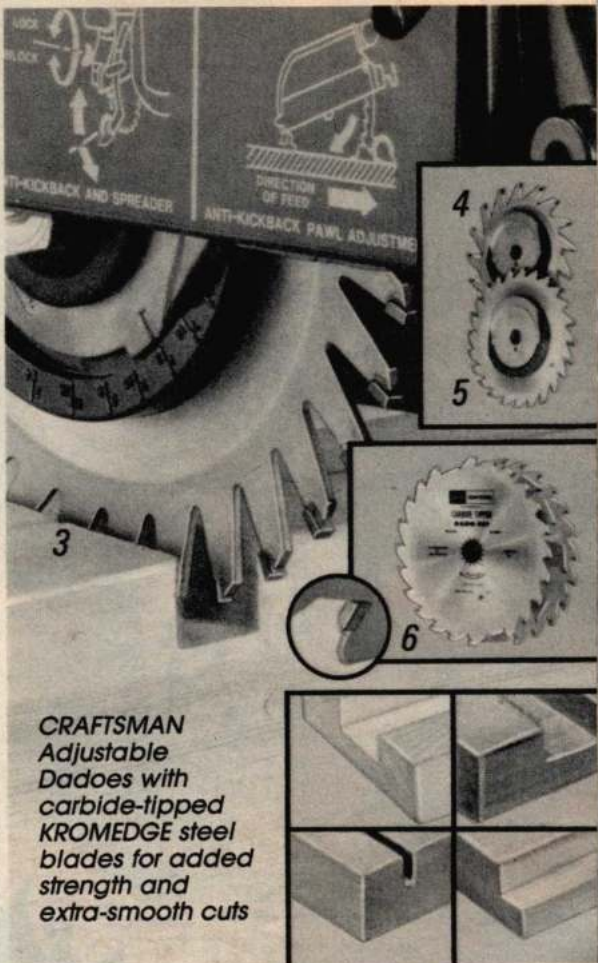

**CRAFTSMAN Adjustable Dadoes** with carbide-tipped blades for added strength and extra-smooth cuts

**7 thru 29** Our Kromedge Cutter-bit Sets include 3 bits in each set (except 25 has 6 bits). Constructed of durable tool steel. All bits cut 1 inch wide.

Item	Type of cut	Catalog Number	Shpg. wt.	Set
(7)	Cabinet Door Lip*	9 R 2353	4 oz.	<b>\$5.49</b>
(8)	Base Molding	9 R 2355	4 oz.	<b>5.49</b>
(9)	Glue joint*	9 R 3201	5 oz.	<b>5.49</b>
(10)	5/8-inch Quarter-round, 5/8-inch Cove (Drop Leaf)*	9 R 3207	5 oz.	<b>5.49</b>
(11)	3/8-in., 3/8-inch Quarter-round 1/4-inch Bead*	9 R 3208	4 oz.	<b>5.49</b>
(12)	Clover-leaf and Screen Mold*	9 R 2354	4 oz.	<b>5.49</b>
(13)	5/8-inch Cove and Bead	9 R 3212	5 oz.	<b>5.49</b>
(14)	1-inch Planer and Joiner*	9 R 2302	2 oz.	<b>5.49</b>
(15)	Window Sash*	9 R 3211	5 oz.	<b>5.49</b>
(16)	"Ogee" Window and Door Stop	9 R 3202	4 oz.	<b>5.49</b>
(17)	1/4-inch Flute and 1/2-inch Cove	9 R 3203	4 oz.	<b>5.49</b>
(18)	5/8-inch Cove	9 R 3209	4 oz.	<b>5.49</b>
(19)	1/4-inch and 1/2-inch Quarter-round	9 R 2351	5 oz.	<b>5.49</b>
(20)	Vee Groove	9 R 3204	4 oz.	<b>5.49</b>
(21)	1-inch Flute (1/2-inch radius)*	9 R 3206	5 oz.	<b>5.49</b>
(22)	Panel Cupboard Door*	9 R 3210	2 oz.	<b>5.49</b>
(23)	Cupboard Door Rail End*	9 R 3213	5 oz.	<b>5.49</b>
(24)	3/8-inch Flute and Quarter-round*	9 R 3205	4 oz.	<b>5.49</b>
(25)	Tongue and Groove. Has six bits*	9 R 2303	2 oz.	<b>10.99</b>
(26)	3-bead (1/4-inch each)*	9 R 2352	5 oz.	<b>5.49</b>
(27)	Raised Panel**	9 R 23215	2 oz.	<b>5.99</b>
(28)	"Ogee" Panel Raising**	9 R 23216	2 oz.	<b>5.99</b>
(29)	Cove Panel**	9 R 23217	2 oz.	<b>5.99</b>

\*Gives full depth-of-cut on 22161 Table Saw, page 122.  
\*\*Use on Radial Arm Saws only

**A** 7-in. diameter, 15-pc. set for 9, 10, 12-in. direct drive radial or table saws. Fits 5/8-in. arbor. Consists of four 3-pc. bit sets (7, 13, 14, 26 above), triple-cutter head, spacer-washer, instr., plastic case. See Note above, right.  
9 R 3218—Wt. 3 lbs. 5 oz. . . Set **\$32.99**  
4 3/4-in. diameter, 21-pc. set for 8, 9, 10-in. belt-driven table saws. Fits 1/2, 5/8-in. arbors. Not for radial saws or 7 1/2-in. table saws. Consists of six 3-pc. bit sets (7, 8, 9, 13, 14, 26 above), triple-cutter head, spacer-washer, instructions, plastic case. See Note above, right.  
9 R 3221—Wt. 2 lbs. 3 oz. . . Set **\$34.99**

7-in. diameter, 27-pc. set for 9, 10, 12-in. radial or table saws. Fits 5/8-in. arbors. Set consists of eight 3-pc. bit sets (7 thru 9, 13 thru 15 and 20, 26 above), triple-cutter head, spacer-washer, instructions and plastic case. See Note above.  
Shipping weight 4 lbs. 3 oz.  
9 R 3217 . . . Set **\$47.99**  
7-in. diameter, Triple-cutter Head alone. Includes spacer-washer and wrench. Bits not included. Use Kromedge bits sold separately above. See Note above. Shipping weight 3 lbs. 6 oz.  
9 R 3214 . . . Set **\$15.99**

**B** Create professional-quality cabinet doors, paneled walls, wainscoting and much more with this Rail and Stile Router Bit Set. Also produces precision-made interlocking joints. Carbide-tipped for longer life. Includes a rail cutter, stile cutter, bushing and guide bearing. Use with CRAFTSMAN router tables.  
9 R 21257—Shpg. wt. 2 oz. . . **\$29.99**

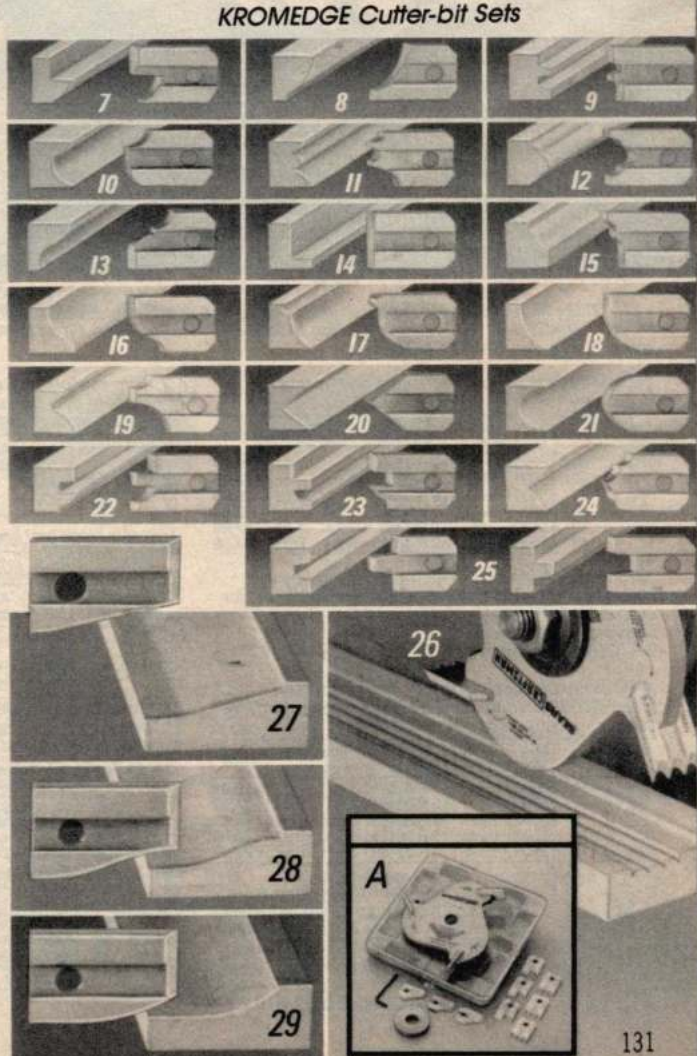
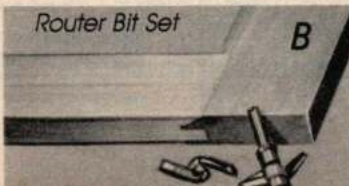

These CRAFTSMAN blades, with tungsten carbide tips cobalt-bonded to steel, are impact-tested to last far longer than any other blade we sell!

Blades 1, 3 and 4 have alternately bevel-ground tips which produce satin-like cuts

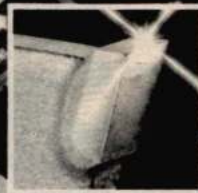

General purpose blade has flat-ground tips for controlled cuts. For cross-cuts, rips, miters, bevels in Masonite® hardboard, Formica® plastic laminate, asbestos, wallboard, soft metals

Trim saw blade for fine, smooth cross-cuts, miters and bevels in woods, laminates, plastics and other materials... with little splintering

Combination blade for coarse cross-cuts, rips, miters, bevels in woods, plywoods, chipboard, Masonite® hardboards, asbestos, wallboard, plastics, soft metals

Our most popular CRAFTSMAN 10-inch blade has 50 carbide tips

Plywood particleboard blade for tough particleboard, comp. board, plywood. Cuts through highly abrasive, dense material with minimal jamming or splintering

Cut-off Blade gives exceptionally smooth, almost splinter-free cuts... thanks to its many teeth and standard (not thin-rim) construction

- ✓ For general purpose cross-cuts, rips, miters, bevels in woods, laminates, plastics, Masonite hardboard, cement products, other materials
- ✓ 8 and 12-inch blades have expansion slots to help guard against warping and heat distortion



**10-in. aluminum cutting blade**

Blade has thin-trim construction for fine cuts. 40 teeth. Maximum depth-of-cut is 1 1/4-inch. Fits 5/8 to 3/4-inch arbors. Max. 5500 rpm. Not for ferrous metals or masonry.  
9 R 32019—Wt. 2 lbs. 6 oz. . \$44.99

thru 7 For high-quality performance under demanding conditions, these tips are cobalt-bonded and impact-tested for outstanding strength. Tips are individually brazed onto blade, then diamond ground to form keen cutting edge. Fit all CRAFTSMAN, Black and Decker, SKIL and other saws with round arbors. Not for ferrous metals and masonry. See SAFETY NOTE below.

Cut-off blade gives smooth cuts and minimal splintering.

Diam. in.	Teeth	Max. RPM	Arbor size, in.	Catalog Number	Shipping weight	Price
7 1/4	40	5700	5/8	9 R 32526	15 oz.	\$25.99
7 1/2	40	5600	5/8-1/2*	9 R 32527	1 lb. 2 oz.	26.99
8	40	5500	5/8-1/2*	9 R 32559	1 lb. 8 oz.	29.99
9	40	5500	5/8-1/2*	9 R 32551	2 lbs. 2 oz.	32.99
10	40	5500	5/8	9 R 3255	2 lbs. 7 oz.	37.99
12	48	3500	5/8	9 R 32555	3 lbs. 9 oz.	44.99

10-inch cut-off blade with 48 triple-ground tips (not shown). Like (1) above, except tips are triple-ground for even smoother, more satin-like cuts. Fits 5/8-in. arbors. Maximum 5500 rpm.  
9 R 3250—Shipping weight 2 lbs. 6 oz. . \$47.99

2 General-purpose blade has tips that project .020/.050 in. above non-cutting edge. Standard (not thin-rim) construction.

Diam. in.	Teeth	Max. RPM	Arbor size, in.	Catalog Number	Shipping weight	Price
7 1/4	14	6000	5/8	9 R 32481	1 lb.	\$16.99
8	12	5500	5/8-1/2*	9 R 32484	1 lb. 8 oz.	14.99
9	12	5500	5/8-1/2*	9 R 32485	2 lbs. 1 oz.	16.99
10	12	5500	3/4-5/8	9 R 32486	2 lbs. 6 oz.	20.99
12	12	3500	1-3/8	9 R 32469	3 lbs. 10 oz.	24.99

Here's a great conversation piece—a shop clock made from a real Craftsman saw blade. Accurate quartz movement runs for about 18 months on 1 "AA" battery (not incl., sold on p. 97). 10-in. in diam.  
9 R 25200—Wt. 2 lbs. 2 oz. . \$19.99

3 Trim saw blade. Designed for professional use. Smooth cuts. Standard (not thin rim) construction. Expansion slots guard against warping.

Diam. in.	Teeth	Max. RPM	Arbor size, in.	Catalog Number	Shpg. wt. lbs. oz.	Price
10	72	5500	5/8	9 R 32556	2 7	\$52.99
12	80	3500	5/8	9 R 32021	4 7	64.99

Trim saw blade (not shown) like (3) except with thin-rim for fine, narrow kerfs. Easily cuts thin or brittle materials with little splintering. Max. cut is 1 1/4 in. deep.

Diam. in.	Teeth	Max. RPM	Arbor size, in.	Catalog Number	Shpg. wt. lbs. oz.	Price
10	60	5500	5/8	9 R 32428	2 6	\$47.99
10	100	5500	5/8	9 R 32554	2 8	74.99
12	100	3500	5/8	9 R 32024	3 8	84.99

4 Combination blade with 24 or 32 tips takes smaller bites than (2) for smoother finish. Standard (not thin-rim) construction.

Diam. in.	Teeth	Max. RPM	Arbor size, in.	Catalog Number	Shpg. wt.	Price
6 1/2	24	6700	3/8-1/2	9 R 32487	13 oz.	\$15.49
7	24	6000	5/8	9 R 32488	1 lb.	16.49
7 1/4	24	5700	5/8	9 R 32489	1 lb. 4 oz.	17.49
7 1/2	24	5600	5/8-1/2*	9 R 32473	1 lb.	18.49
9	24	5500	5/8-1/2*	9 R 32471	1 lb. 15 oz.	23.99
10	24	5500	5/8	9 R 32476	2 lbs. 4 oz.	25.99
12	24	3500	5/8	9 R 32477	3 lbs. 2 oz.	32.99

7	32	6000	5/8	9 R 32542	15 oz.	15.99
7 1/4	32	5700	5/8	9 R 32543	1 lb. 1 oz.	15.99
7 1/2	32	5600	5/8	9 R 32544	1 lb. 2 oz.	15.99

Combination blade (not shown) is like (4) except has 16, 18 or 20 tips.

Diam. in.	Teeth	Max. RPM	Arbor size, in.	Catalog Number	Shipping weight	Price
5 1/2	16	8000	1/2	9 R 32513	7 oz.	\$7.99
6 1/2	16	6700	5/8-1/2*	9 R 32514	11 oz.	8.49
7	18	6000	5/8	9 R 32517	13 oz.	8.99
7 1/4	18	5700	5/8	9 R 32518	13 oz.	9.99
7 1/2	18	5600	5/8-1/2*	9 R 32519	14 oz.	10.99
10	20	5500	5/8	9 R 32531	1 lb. 13 oz.	17.99

5 All-purpose blade for table and radial saws smoothly cuts solid wood, plywood, particleboard in either cross-cuts or ripping operations.

Diam. in.	Teeth	Max. RPM	Arbor size, in.	Catalog Number	Shpg. wt.	Price
7 1/2	35	5700	5/8	9 R 32041	1 lb.	\$29.99
8	35	5500	5/8	9 R 32042	1 lb. 6 oz.	37.99
10	50	5500	5/8	9 R 32037	2 lbs. 7 oz.	47.99

6 Plywood, particleboard blade.

Diam. in.	Teeth	Max. RPM	Arbor size, in.	Catalog Number	Shipping weight	Price
7-7/8	24	6000	5/8*	9 R 32560	13 oz.	\$14.99
8	24	5500	5/8*	9 R 32561	1 lb. 5 oz.	24.99
10	40	5500	5/8*	9 R 32570	1 lb. 13 oz.	39.99

††Excellent for cutting nails in floorboards \* 1/2-inch bushing provided

SAFETY NOTE: Play it safe... protect your eyes with our safety goggles sold on page 137



# CRAFTSMAN® Kromedge blades are chromium-fortified to resist rust . . . last longer than ordinary steel blades



8 thru 13 These popular blades are made of chrome-nickel steel and heat-treated for super hard and smooth surfaces. Resist gumming, burning and dulling. Fit all CRAFTSMAN®, Black and Decker®, SKIL® and other saws with round arbors. See SAFETY NOTE on opposite page.

**8 Plywood and veneer blade**

Diam. in.	Teeth	Arbor size, in.	Max. RPM	Catalog Number	Wt.		Price
					lb.	oz.	
6½	150	¾-½"	6400	9 R 32532	8		\$8.49
7	200	¾"	6000	9 R 32534	11		8.79
9	200	¾-½"	5500	9 R 32538	1	8	12.79
10	200	¾"	5500	9 R 32539	1	12	15.79

**9 Hollow-ground planer blade**

Diam. in.	Sections	Teeth	Arbor size, in.	Max. RPM	Catalog Number	Wt.		Price
						lbs.	oz.	
7	11	44	¾"	6000	9 R 32422	9		\$8.29
7½	12	48	¾"	5700	9 R 32423	12		8.79
7½	12	48	¾-½"	5700	9 R 32421	13		9.29
8	12	48	¾-½"	5500	9 R 32424	1	4	10.29
8½	13	60	¾"	5500	9 R 32428	1	8	10.99
9	14	56	¾-½"	5500	9 R 32425	1	4	12.79
10	16	64	¾"	5500	9 R 32426	1	8	15.79
12	19	76	¾"	3500	9 R 32427	2	9	18.99

\*½-in. bushing provided

**10 Rip blade**

Diam. in.	Teeth	Arbor size, in.	Max. RPM	Catalog Number	Wt.		Price
					lb.	oz.	
7	30	¾"	6000	9 R 32563	9		\$4.79
7½	30	¾"	5700	9 R 32564	11		5.29
10	36	¾"	5500	9 R 32567	1	10	8.79

**11 Chisel-tooth combination blade**

Diam. in.	Teeth	Arbor size, in.	Max. RPM	Catalog Number	Wt.		Price
					lbs.	oz.	
4	30	½"	8000	9 R 32401	3		\$3.79
5½	24	½"	8000	9 R 32438	7		4.29
6½	24	¾-½"	6400	9 R 32663	9		4.79
7	26	¾"	6000	9 R 32669	10		4.79
7½	26	¾"	5700	9 R 32664	14		5.29
7½	26	¾-½"	5600	9 R 32665	15		5.79
8	28	¾-½"	5500	9 R 32666	14		6.79
9	28	¾-½"	5500	9 R 32667	1	4	7.79
10	28	¾"	5500	9 R 32668	1	11	8.79
12*	24	¾"	3500	9 R 32702	2	12	12.79

\*\*This blade best suited for heavy-duty ripping

**12 Master combination blade**

Diam. in.	Sections	Teeth	Arbor size, in.	Max. RPM	Catalog Number	Wt.		Price
						lbs.	oz.	
6½	12	48	¾-½"	6400	9 R 32492	8		\$4.79
7	12	48	¾"	6000	9 R 32493	9		4.79
7½	15	60	¾"	5700	9 R 32494	11		5.29
7½	15	60	¾-½"	5600	9 R 32495	12		5.79
8	12	48	¾-½"	5500	9 R 32496	1	8	6.79
9	16	64	¾-½"	5500	9 R 32497	1	2	7.79
10	16	64	¾"	5500	9 R 32498	1	10	8.79
12	18	72	¾"	3500	9 R 32499	3	2	12.79

**13 Crosscut plywood blade, ¼ in. depth of cut**

Diam. in.	Teeth	Arbor size, in.	Max. RPM	Catalog Number	Wt.		Price
					lb.	oz.	
4	100	½"	8000	9 R 32441	3		\$3.79
5½	100	½"	8000	9 R 32439	7		4.29
6½	150	¾-½"	6400	9 R 32442	8		4.79
7	200	¾"	6000	9 R 32443	10		4.79
7½	200	¾"	5700	9 R 32444	10		5.29
7½	176	¾-½"	5600	9 R 32449	14		5.79
8	100	¾-½"	5600	9 R 32443	14		6.79
8½	100	¾"	5500	9 R 32546	14		6.99
9	200	¾-½"	5500	9 R 32448	1	3	7.79
10	200	¾"	5500	9 R 32446	1	10	8.79



**14** Blade-setting tool for alternately setting teeth on 4 to 16-in. circular blades (except carbide-tipped or disposable). Use before sharpening. Steel, cast-iron and aluminum. Imported. 9 R 25166—Shpg. wt. 6 lbs. 8 oz. . . \$69.99



**15** Reconditioning attachments for 6-in. or larger bench grinders lets you resharpen, reshape saw blade points. Swing to side when not using. Locating cone automatically centers blade. For circular blades (except carbide-tipped or disposable) up to 16-in. diam. 6-in. grinding wheel fits ½, ¾, 1-in. arbors. Cone fits up to 2-in. round, diamond, sq. arbor holes. Order (14) above. Imported. 9 R 25167C—Shpg. wt. 14 lbs. . . \$69.99



**16** Gum and pitch remover. 16-fluid oz. can. 9 R 49191—Wt. 1 lb. 5 oz. . . Can \$2.99

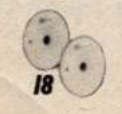

**18** CRAFTSMAN blade stabilizers help keep blade rigid for precise cuts. For carbide-tipped, most regular blades 8 to 12-in. diam. 4-in. diam. stabilizer fits ¾-in. arbor. Tempered steel. Pkg. of 2. 9 R 4952—Shpg. wt. 12 oz. . . Pkg. \$7.79

## Blade Accessories



**19** 10-in. sanding disc is made of durable tempered steel. Fits ¾-inch arbors. 9 R 22723—Shpg. wt. 2 lbs. 8 oz. . . \$8.99

8-in. sanding disc (not shown). For ¾-in. arbors. 9 R 22741—Shpg. wt. 1 lb. 12 oz. . . \$6.99

Sanding discs for wheels above. 3-in. center. Pkg. of 6, two ea. fine, med., coarse.

Size	Catalog No.	Shpg. wt.	Pkg.
10-in. . . . .	9 R 22731	11 oz.	\$3.89
8-in. . . . .	9 R 22732	10 oz.	2.79

Adhesive-backed sanding discs for wheels above. Pkg. of 6, two ea. Fine, med., coarse.

6x3-in. . . . .	9 R 22735	10 oz.	\$3.99
10x3-in. . . . .	9 R 22725	11 oz.	4.99

**20** CRAFTSMAN Kromedge value blades are constructed of durable tempered steel. Has 40 teeth.

Diam.	Arbor size	Catalog No.	Shpg. wt.	Price
5½-in. . . . .	½-in.	9 R 32291	6 oz.	\$3.29
7-in. . . . .	¾-in.	9 R 32292	9 oz.	3.29
7½-in. . . . .	¾-in.	9 R 32293	10 oz.	3.29
7½-in. . . . .	¾-½-in.	9 R 32294	11 oz.	3.29



**21** Replacement diamond-arbor Kromedge saw blades for SKIL® worm-drive circular saws.

Size in.	Catalog Number	Shpg. wt.		Price
		lb.	oz.	
<b>Steel Blades (36 teeth)</b>				
6½	9 R 32306	8		\$4.49
7½	9 R 32307	12		4.69
8½	9 R 32308	1	8	5.29

Size in.	Catalog Number	Shpg. wt.		Price
		lb.	oz.	
<b>Carbide Blades (24 teeth)</b>				
6½	9 R 32453	11		\$14.49
7	9 R 32455	15		17.49
8½	9 R 32456†	1	4	20.99

†Includes ¾-inch round bushing

Blade cleaning kit (not shown) cleans gum, pitch, resin, etc. from saw blades, drill bits, router bits, chain saw blades, and other woodworking tools. Incl. 4 oz. cleaning solution, brass brush, immersing tray, protective gloves and instructions. 9 R 22749—Shpg. wt. 1 lb. 6 oz. \$9.99

## Powerful, accurate CRAFTSMAN®

✓ Designed to produce the accurate, quality cuts you need to get the job done

### Aluminum table saws



#### 1 9-inch direct drive table saw

- ✓ ¾-HP motor develops maximum 1.6 HP
- ✓ Aluminum extensions offer a 37x20-inch work surface
- ✓ Sturdy leg stand included

**\$279<sup>99</sup>**



#### 2 10-inch direct-drive table saw

- ✓ Motor rated at 1 HP develops maximum of 2 HP
- ✓ Steel extensions provide a generous 40x27-inch work surface
- ✓ Includes rugged steel leg stand

**\$379<sup>99</sup>**

### Save \$25



when you buy (1) or (2) in combination with our 3-pc., Excalibur industrial-quality carbide-tipped blade set!

A

### Save \$10

when you buy (1) or (2) in combination with this versatile accessory set!



B

A Excalibur industrial-quality blades have extra-thick carbide tips that provide smooth cuts and long life. 10-in. blades resist gumming, burning and dulling much better than ordinary steel. Fit saws with ¾-in. arbor. Max 5500 rpm. Incl. 24-tooth rip, 60-tooth crosscut, 50-tooth Master Combination blade. Sold separately on page 129.

Blade set combination	Catalog Number	Wt. lbs.	Sep. prices total	Saw with set
With Saw (1)	9 R 24156N	85	\$419.96	\$394.96
With Saw (2)	9 R 24151N	133	519.96	494.96

B Accessory set incl. flexible mask impact goggles with ventilated side shields; 10-in. diameter sanding disc; one 10-in., 64-tooth Master Combination blade; one 10-in., 200-tooth crosscut plywood blade. Items sold separately on page 133 and 138.

Access set combination	Catalog Number	Shpg. wt. lbs.	Sep. prices total	Saw with set
With Saw (1)	9 R 24175N	83	\$309.75	\$299.75
With Saw (2)	9 R 29858N	132	409.75	399.75

On these two pages, you'll find our selection of Craftsman table saws to satisfy any home or professional workshop need. All are warranted by Sears. Write for free copy, see page 148. We've also included savings if you buy (1 or 2) with either the Excalibur blade set (A) or accessory (B) shown at left. Craftsman bench power tools are America's Best Sellers for a very good reason... our customers won't settle for second best!

1 and 2 Craftsman aluminum table saws feature direct-drive saws with induction run motors, miter gauge and self-aligning pick-off type rip fence. Positive bevel stops at 45°, 90°. Spreader minimizes blade binding. Handwheels control blade elevation and tilt. Legs have rubber padded leveling feet. 6-ft., 3-wire cord. 120-v., 60-Hz. AC. See our Buying Guide Chart below for ordering information.

1 \$12 MONTHLY, (see p. 148). Rips 18 in. right and 16 in. left. Table surface in front of blade at 1-in. cutting depth is 10¼ in.

2 \$15 MONTHLY, (see p. 148). 24-in. right rip capacity. Table surface in front of blade at 1-in. cutting depth is 15¼ in. Incl. Exact-I-Cut indicator.

3 and 4 Craftsman high-quality cast-iron table saws feature capacitor-start, induction-run motors. Quick-measuring rip scales; 24-in. rip cap. Deluxe miter gauge, (on 4 and 5 only), has positive stops at 90° and 45° for quick, accurate miter cuts. See-thru blade guards have spreaders and anti-kickback pawls. Exact-I-Cut indicator shows where wood will meet blade. 6-ft., 3-wire cord. 120-v., 60 Hz. AC. Order from Chart below.

3 \$16 MONTHLY, (see p. 148). Table surface in front of blade at 1-in. cutting depth is 15¼ in.

4 \$19 MONTHLY, (see p. 148). Table surface in front of blade at 1-in. cutting depth is 15½ in.

For your convenience, we've provided this quick-check Buying Guide so you can shop and compare our products with those of competitors. Included are some of the most important features our products offer, to give you the quality you expect from Craftsman!

Item No.	Catalog Number	Table size, in.	Motor max. HP	Depth of cut at 90°, in.	Depth of cut at 45°, in.	Quick release rip fence	Miter gauge type	Shipping weight pounds	Price
(1)	9 R 24173N	37x20	1.6	2	1½	no	small	75	\$279.99
(2)	9 R 29805N	40x27	2	2½	2¼	no	std.	126	379.99
(3)	9 R 29803N	40x27	2	3¾	2¼	yes	std.	215	449.99
(not shown)	9 R 22668N	44x27	2	2½	2¼	no	std.	179	399.99
(4)	9 R 29874N	44x27	2	3¾	2¼	yes	std.	241	549.99

## table saws... tools we're proud of for work you'll be proud of!

✓ Controls are arranged for quick access to let you work comfortably as well as efficiently

✓ Powerful motors develop more than their rated horsepower so you can count on them for the tough jobs

### Cast iron table saws



10-inch belt-drive table saw has our largest work surface

**\$549<sup>99</sup>**

4

✓ 1 HP motor develops maximum 2 HP

✓ Tough cast iron extensions provide 44x27-inch work surface

✓ Cast iron work table is extra durable, extra stable

✓ Includes steel legs and stop rods for repetitive cutting

✓ Includes 4 casters



3

10-inch belt-drive table saw

**\$449<sup>99</sup>**

✓ 1 HP motor develops maximum 2 HP

✓ Steel extensions provide 40x27-inch work surface

✓ Includes deluxe miter gauge and steel leg stand

ONE QUALITY NAME

**CRAFTSMAN**

OFFERS MORE GOOD CHOICES

# Accessories that add convenience, precision and versatility to your table saw

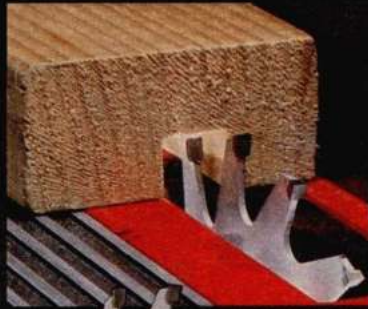

Steel triple-cutter molding head



3-pc. Kromedge cutter bit sets

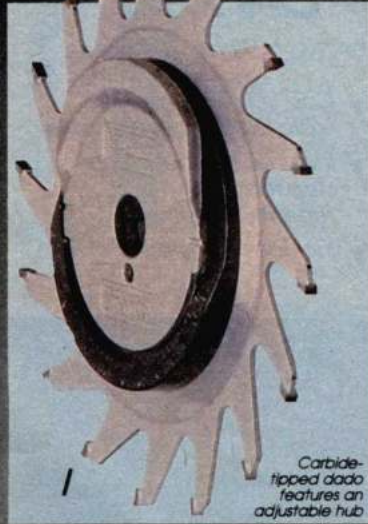

Carbide-tipped dado features an adjustable hub

Turn your table saw into a disc sander with this 8-in. diam. sanding disc

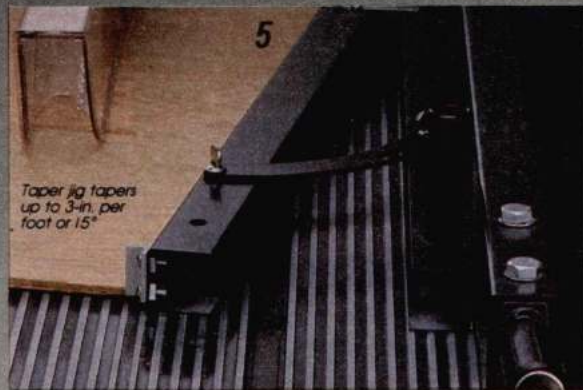

Taper jig tapers up to 3-in. per foot or 15°



Flexible mask impact goggles



CRAFTSMAN table saw accessory kit includes items (1 thru 6). Separate prices total \$92.61. Shpg. wt. 9 lbs. 10 oz. 9 R 32783... Kit \$77.99

1 Carbide-tipped adjustable dado has adjustable hub that lets you dial widths from 3/8 to 1 3/8-in. without removing dado. 7-in. heat-treated steel Kromedge body. 16 diamond-ground, carbide-tipped teeth. 3/4-in. diam. hole, 3/8-in. bushing. Max. 1 1/2-in. depth of cut. Use with 9, 10, 12 or 14-in. table saws. Shpg. wt. 2 lbs. 8 oz. 9 R 3263... \$32.99

2 8-in. diam. sanding disc has adjustable hub that lets you dial widths from 3/8 to 1 3/8-in. without removing dado. 7-in. heat-treated steel Kromedge body. 16 diamond-ground, carbide-tipped teeth. 3/4-in. diam. hole, 3/8-in. bushing. Max. 1 1/2-in. depth of cut. Use with 9, 10, 12 or 14-in. table saws. Shpg. wt. 2 lbs. 8 oz. 9 R 3263... \$32.99

3 Steel triple-cutter molding head incl. spacer-washer and wrench. Wt. 3 lbs. 6 oz. 9 R 3214... \$15.99

4 3-pc. Kromedge cutter bit sets all cut 1-in. wide.

Cabinet door lip  
9 R 2353—Wt. 4 oz... \$5.49  
3-bead (1/4-in. ea.)  
9 R 2352—Wt. 5 oz... \$5.49  
3/8-in. cove, bead  
9 R 3212—Wt. 5 oz... \$5.49  
1-in. jointer and planer  
9 R 2302—Wt. 2 oz... \$5.49

**Save \$14**  
when you buy our table saw accessory kit (Items 1 thru 6)

5 Taper jig tapers up to 3-in. per foot or 15°. Handle and scale in degrees of taper and inches per foot for accuracy. Has locking brackets. Shpg. wt. 2 lbs. 9 R 3233... \$11.49

6 Flexible mask impact goggles have perforated side shields for ventilation. Adjustable. 9 R 1859—Wt. 2 oz... \$3.19

**SHOP BY PHONE**  
To order, call your local Sears store

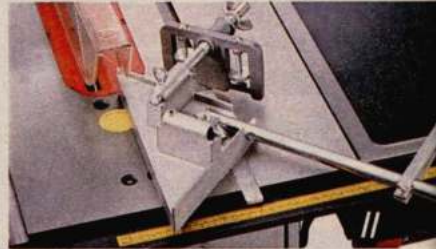

27-in. quick release rip fence



Magnifying light is great for fine detail work



Side extension table gives you 576 sq. in. extra work space!

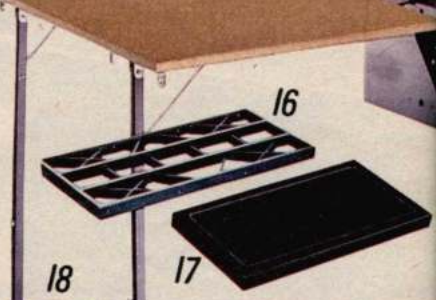

Sawdust collection systems



**CRAFTSMAN table saw guard assembly**

23

**Picture framing kit adjusts to handle most size frames**

24

25

**CRAFTSMAN 18-gauge steel adjustable leg sets**

26

27

28

29

**Disposable masks for non-toxic materials**

30

**Paint spray/insecticide respirator**

31

32

33

34

37

35

36

38

**Safety Accessories**

**7** Fits 3/4-in. wide, 3/8-in. deep miter groove. Cuts to 2-in. thick. Includes 2 die cast plates and 2 aluminum clamps.  
9 R 3236—Shpg. wt. 4 lbs. . . \$31.99

**8** CRAFTSMAN hold-down clamp holds stock firmly to miter gauge for more accurate cuts. For (9) below. Not for table saws 9-2415, 9-24151, 9-2416, 9-22161, 9-2413. Will not fit miter gauge 9-24214.  
9 R 29928—Shpg. wt. 1 lb. 9 oz. . . \$27.99

**9** CRAFTSMAN miter gauge with degree indicator has positive stops at 90° and 45° left or right. Fits most table saws, other tools with 3/4x3/8-in. deep miter groove. Not for use with table saws 9-2413, 9-2415, 9-24151, 9-2416, 9-22161.  
9 R 29929—Shpg. wt. 2 lbs. . . \$27.99

**10** CRAFTSMAN length stop rods let you make duplicate cuts quickly and accurately. For (9); fits most other Craftsman miter gauges.  
9 R 29924—Shpg. wt. 13 oz. . . \$9.99

**11** Miter square holds sections of frames for square-joint cuts.  
9 R 3216C—Shpg. wt. 3 lbs. 10 oz. . . \$23.99

**12** 27-in. quick-release rip fence is self-aligning for accuracy. Not Craftsman.  
9 R 22263C—Shpg. wt. 9 lbs. . . \$34.99

**13** Light has 3-power lens. Adjusts to fit any surface. Grooved tray holds pencils, etc. Steel and plastic. 120-v. AC. Takes 60-w. bulb, not incl.  
9 R 2470C—Shpg. wt. 4 lbs. . . \$39.99

**14** Work light has 34-in. steel arm. Mounts on bench or wall. Use 75-w. bulb (not incl.).  
9 R 2484—Shpg. wt. 2 lbs. 15 oz. . . \$19.99

**15** Made of 3/8-in. heavy-duty particle board with steel frame, Craftsman side extension table is 24x24-in. long. Top and legs are angle-braced for strength. Fits most Craftsman 10-in. table saws. Folds for storage.  
9 R 32799C—Shpg. wt. 15 lbs. . . \$34.99

**16** Cast iron table saw extension fits most Craftsman 10 or 12-in. table saws with cast-iron tops incl. 2418-25, 29065, 29803-14-15-24, 29904-12-14, 24168, 12x27 inches. Imported. Not Craftsman.  
9 R 22261C—Shpg. wt. 25 lbs. . . \$49.99

**17** 10x20 inch steel table saw extension. Fits 2404-11-14-24-27, 2914-57-58, 24042, 24114-41-92, 24246-72, 29575-82. Also fits 2428, 24281-82, when used with adapter kit below. Not Craftsman.  
9 R 29956—Shpg. wt. 8 lbs. 11 oz. . . \$36.99

**10x27-in. table saw extension. Fits saws 2418-25, 29803-05-14-24-34, 29904-12-14-65.**  
9 R 29968C—Shpg. wt. 12 lbs. . . \$39.99

**10x27-in. Fits saws above plus 2993-94-95-96-97, 29813, 29913 when used with adapter kit below.**  
9 R 29957C—Shpg. wt. 10 lbs. 1 oz. . . \$39.99

**Saw adapter kit for 9-29956, 9-29957 above.**  
9 R 29999—Shpg. wt. 15 oz. . . Kit \$11.99

**Rip fence bar increases rip cap. to 24-in. right or left. For saws with 20x27-in. cast-iron tables.**  
9 R 29969C—Wt. 18 lbs. . . \$39.99

**18** CRAFTSMAN table saw book describes over 600 operations. Illustrated, 207 pages.  
9 R 2918—Shpg. wt. 14 oz. . . \$7.99

**19** Dado Insert for table saw 22161. Required when using dado set.  
9 R 22281—Shpg. wt. 5 oz. . . \$8.99

**Molding Insert (similar to (19)) for table saw 22161. Required when using molding head.**  
9 R 22282—Shpg. wt. 5 oz. . . \$8.99

**20** Combination dado/molding inserts. Not Craftsman.

Fits saws	Cat. No. 7-in.	Cat. No. 8-in.	Wt.		Price
			lbs.	oz.	
12-in.** 2425	9 R 29997	9 R 22287	1	10	\$14.99
10-in.* 29802-3, 29814, 29815, 29821-24-25, 22106, 22683, 2906, 29006, 29065, 29809, 29872-4	9 R 29997	9 R 22287	1	10	14.99
10-in.* 29847, 2990-94-96, 29901-02-03-04-11-12-14-41-42-43	9 R 29994		1	11	14.99
10-in.** 2404, 2957, 29575, 2958, 29582, 29805-07, 29834	9 R 29933		1	1	13.99
9-in.** 2419, 24192, 2424-27, 24246, 24272		9 R 22289	1	1	14.99
10-in.** 24168-69	9 R 22271		1	10	13.99
10-in.** 24168-69		9 R 22285	1	10	14.99
9-in.** 24173	9 R 22272	9 R 22286	1	1	14.99

\*Belt drive \*\*Direct drive \*\*\*Flex drive  
8-in. dado/molding insert fits same saws as 29994.  
9 R 22288—Shpg. wt. 1 lb. 12 oz. . . \$19.99

**21** Sawdust collection system collects dust above and below cutting level and deposits it into cloth filter bag. Fits Craftsman 9, 10-in. direct-drive table saws sold after 1976 (except will not fit 24173). Incl. cloth filter bag, hose, support and replacement blade guard. Not Craftsman.  
9 R 29967—Shpg. wt. 6 lbs. . . \$89.99

Sawdust collection system (not shown) is similar to (21). Fits Craftsman 10-in. flex-drive saws 24168, 24169.  
9 R 24242—Shpg. wt. 6 lbs. . . \$89.99

**22** Sawdust collection system with impeller has vac attachment; uses saw motor to draw dust into cloth filter bag. Fits most Craftsman belt-drive 10-in. table saw outfits sold after 1973. Not for electronic table saws. 2 cloth filter bags, hose, support, replacement blade guard incl. Not Craftsman.  
9 R 29966—Shpg. wt. 14 lbs. . . \$129.99

**23** CRAFTSMAN table saw guard assembly has spreader to help prevent wood from binding. See-thru guard, anti-kickback pawls. Fits former 9-2990, 9-2991, 9-2992, 9-2994, 9-2999.  
9 R 29906—Shpg. wt. 4 lbs. . . \$44.99

**24** Picture framing kit adjusts from 4x4 to 35x35 in. square to handle most size frames. Incl. adjustable aluminum framing clamp for gluing, X-acto® mat cutter, and miter square (11).  
9 R 32059C—Shpg. wt. 10 lbs. 7 oz. . . Kit \$49.99

**25 and 26** CRAFTSMAN 18-gauge steel adjustable leg sets. Unassembled.

**25** For 9, 10-in. table saw  
9 R 22235C—Shpg. wt. 19 lbs. . . \$64.99

For band saws (except 2442, 24451) shapers, belt-disc sanders (except 22642).  
9 R 22236C—Shpg. wt. 28 lbs. . . \$64.99

For CRAFTSMAN 7 1/2-in. table saw  
9 R 22237C—Shpg. wt. 24 lbs. . . \$64.99

For CRAFTSMAN sander grinders  
9 R 22239C—Shpg. wt. 26 lbs. . . \$64.99

**26** For CRAFTSMAN radial saws (except 19811, 21, 31, 41, 51, 61).  
9 R 22238C—Shpg. wt. 32 lbs. . . \$64.99

For CRAFTSMAN miter saws (except 23355, 2347)  
9 R 22246C—Shpg. wt. 32 lbs. . . \$64.99

For CRAFTSMAN jointer-planers (except 23622)  
9 R 22245C—Shpg. wt. 30 lbs. . . \$64.99

**27** Caster set has 2 front-swivel casters with foot-operated height lever and 2 non-swivel rear casters. Supports up to 400 lbs. Not Craftsman.  
9 R 22221—Shpg. wt. ea. 6 lbs. . . Set ea. \$44.99  
When you buy 2 or more ea. . . \$38.24

**28** Caster set has 4 swivel casters with foot-operated height lever. Holds up to 400 lbs. Not Craftsman.  
9 R 22222—Shpg. wt. ea. 10 lbs. . . Set ea. \$54.99  
When you buy 2 or more ea. . . \$46.74

Set of 4 ball-bearing swivel-type casters with 2 actuators. For radial saws 19831, 19841, 19851, 19861. Not Craftsman.  
9 R 22254—Shpg. wt. 4 lbs. 8 oz. . . Set \$54.99

**29** Disposable mask for non-toxic dusts, powders.  
9 R 18539—Pkg. of 25. Wt. 7 oz. . . Pkg. \$7.99

CRAFTSMAN face shield (not shown), for total face protection.  
9 R 18613—Shpg. wt. 8 oz. . . \$12.79  
9 R 18614—Replacement window. Wt. 3 oz. . . \$5.19

**30** Industrial-quality respirator provides protection against paint sprays, organic vapors, pesticides, dust, fumes, mists, asbestos-containing dusts and mists. Rubber facepiece, adjustable headband. Order replacement cartridges below.  
9 R 18574—Shpg. wt. 10 oz. . . \$29.99  
Replacement cartridges for (30). Pkg. of 2.  
9 R 18575—Shpg. wt. 8 oz. . . \$12.99

**31** Craftsman paint spray respirator. Not for ammonia.  
9 R 18552—Shpg. wt. 15 oz. . . \$22.99  
9 R 18554—2 extra filters. Wt. 1 oz. . . Pkg. \$2.49  
9 R 18553—2 filter cartridges. Wt. 6 oz. . . \$8.49

**32** Craftsman dust/mist respirator for most dusts.  
9 R 1852—Shpg. wt. 7 oz. . . \$12.49  
9 R 18525—Pkg. of 5 extra filters. Wt. 1 oz. . . \$3.49

**33** CRAFTSMAN insecticide respirator for most pesticides.  
9 R 18571—Shpg. wt. 14 oz. . . \$21.99  
9 R 18572—Replacement filter. Wt. 5 oz. . . \$9.99

**34** Hearing protector with foam air cushions and adjustable headband.  
9 R 1863—Shpg. wt. 8 oz. . . \$14.99

**35** CRAFTSMAN hardhats. Fully dielectric.  
9 R 18627—Yellow. Wt. 13 oz. . . \$3.99  
9 R 18626—White. Wt. 13 oz. . . \$3.99

**36** Protective polycarbonate glasses.  
9 R 18642—Wt. 1 oz. . . \$9.49  
9 R 18633—Replacement lens. Wt. 1 oz. . . \$2.69

**37** Protective light-duty eye guards. Help protect eyes from minor impact. Fit over glasses.  
9 R 18645—Clear. Shpg. wt. 2 oz. . . \$1.99  
9 R 18646—Tinted. Shpg. wt. 2 oz. . . \$1.99

**38** Polycarbonate glasses give you heavy-duty eye protection from flying chips and particles. Not for use when welding. Wt. ea. 3 oz.  
9 R 18650—Slate frame/clear lens . . . \$4.99  
9 R 18652—Mocha frame/grey lens . . . \$4.99

Dust and chemical goggles fit over glasses. Have indirect side vents, rubber headband.  
9 R 18593—Shpg. wt. 4 oz. . . \$3.99  
9 R 18591—Extra lens. Wt. 1 oz. . . \$1.79

Welding goggles have number 5 filter for cuts to 6-in. thick, welds to 1/8-in. thick.  
9 R 18636—Shpg. wt. 6 oz. . . \$10.49

ONE QUALITY NAME

**CRAFTSMAN**

OFFERS MORE GOOD CHOICES

Add versatility and convenience to your



Carbide-tipped adjustable dado features hub to let you dial any width from 3/16 to 13/16-in.!



Triple-cutter molding head with spacer-washer and wrench



3-pc. Kromedge cutter bit sets

Accessory kit includes items (1 thru 8). Fits 9, 10 and 12-in. radial saws with 3/8-in. arbors. Not for radial saws with universal motors. Separate prices total \$98.62. 9 R 32781—Wt. 9 lbs. 5 oz. Kit **\$79.99**

Carbide-tipped adjustable dado features hub to let you dial widths from 3/16 in. to 13/16 in. without removing dado. Laps, ploughs, dados, joints and more on laminates and sensitive materials. 7-in. Kromedge blade has 16 diamond ground carbide-tipped teeth. 3/8-in. arbor. 1 1/2-in. max. depth of cut. Use with 9, 10, 12 and 14-in. radial and table saws only. 9 R 3263—Wt. 2 lbs. 8 oz. **\$32.99**

2 Triple-cutter molding head includes spacer-washer, wrench. Bits not incl. Use radial saw molding head guard (6) or table saw inserts on page 137. 9 R 3214—Wt. 3 lbs. 6 oz. **\$15.99**

3 and 4 Kromedge cutter bit sets include 3 bits per set. Cut 1 inch wide.

3 Cabinet Door Lip 9 R 2353—Wt. 4 oz. Set **\$5.49**

4 1-in. planer and jointer 9 R 2302—Wt. 5 oz. Set **\$5.49**

5 Holds workpiece in place for accurate, smooth cuts... even holds round workpieces. Includes clamp, rounded rod and 4 hooks. Not for saws sold on p. 140. 9 R 29502—Wt. 1 lb. 3 oz. **\$14.99**



Hold-down clamp gives you the stability needed to make smooth, accurate cuts



Molding head/dado guard is necessary when saw shaft is in vertical position

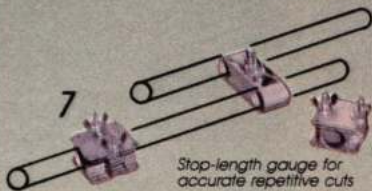

Stop-length gauge for accurate repetitive cuts



Protect your eyes with these comfortable, flexible mask impact goggles

**Save \$18** when you buy our CRAFTSMAN radial saw accessory kit... includes items (1 thru 8)

6 Molding head/dado guard must be used with molding head and dado blades when saw shaft is in vertical position. Not for use with former radial saw 9-2922. Up to 8-inch diameter. 9 R 29523—Wt. 1 lb. 1 oz. **\$11.49**

7 Stop-length gauge for accurate repetitive cuts. Use two 3/4-in. dowel rods. Incl. 1 adjustable, 2 permanent clamps. Not for saws sold on p. 140. 9 R 3242—Wt. 13 oz. **\$8.99**

8 Flexible mask impact goggles have polycarbonate plastic lenses. Fit over regular glasses. 9 R 1859—Wt. 2 oz. **\$3.19**



New at Sears! CRAFTSMAN side extension table provides 384-sq. in. extra work space!

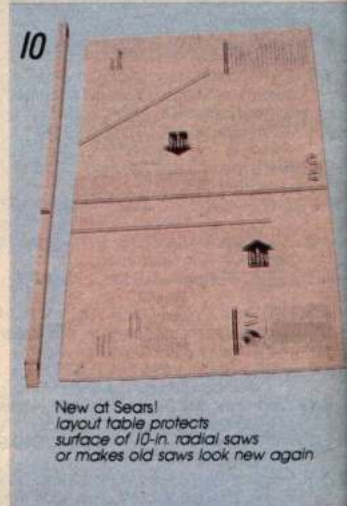

New at Sears! layout table protects surface of 10-in. radial saws or makes old saws look new again



Rotary surface planer includes 3 carbide-tipped steel blades



CRAFTSMAN Radial Saw Book

# radial saw with any one of these Accessories!

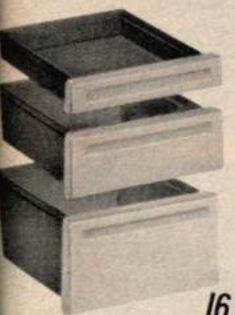

**16**  
3-drawer  
radial saw pack



**19**  
Hold-down  
attachment has  
2 clamps and 4  
holding fingers



**20** New  
at  
Sears!  
CRAFTSMAN  
sawdust collector



**22**



Adjustable  
work  
support  
table is  
great for  
longer  
wood  
pieces

**23**



**21**

8-in. diam. buffing wheel



**24**

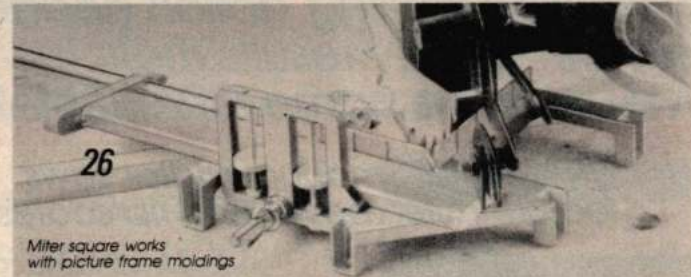

**26**  
Miter square works  
with picture frame  
moldings

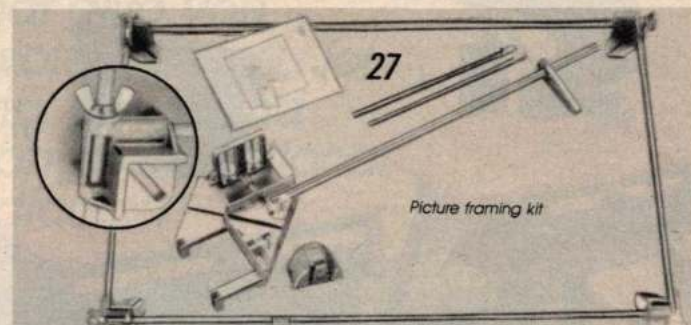

**27**

Picture framing kit



**28**



**29**



**30**

**9** Craftsman side extension table is 16x24-in. long, of 3/4-in. heavy-duty particleboard with a steel frame. Gives you both extra work space and support for long stock or paneling. Top and legs are angle-braced for strength. For most Craftsman 10-in. radial saws. Folds for storage.  
9 R 32795C—Wt. 11 lbs. . . \$24.99

**10** Hardboard layout table has crosscut alignment marks at 0° and 45° for accuracy. Compound angle reference chart. In and out rip scales; conversion chart from decimals to fractions. Fits Craftsman 10-in. radial saws sold on p. 140. 44 1/2 x 17 3/8-inches long. Wood fence not included.  
9 R 32766—Wt. 9 lbs. 12 oz. \$14.99

Makes old saws look new again. Crosscut alignment marks at 0° and 45° for accuracy. Compound angle reference chart. In and out rip scales. Fits most former Craftsman 10-in. radial saws. Wood fence not incl. Not for use with saws sold on p. 140. See "N" note, p. 148.  
9 R 32768N—Wt. 9 lbs. 12 oz. \$14.99

**11** Rotary surface planer planes up to 2-in. path. Incl. 3 carbide tipped steel blades. For radial saws with 5/8-in. arbor except (9-2922).  
9 R 29513—Wt. 12 oz. . . \$18.99

Extra 3-pc. blade set for (11)  
9 R 29531—Wt. 1 oz. Set \$10.99

**12** Craftsman Radial Saw Book has instructions on use of radial saws and a variety of other bench power tools. 224 pages.  
9 R 2917—Wt. 14 oz. . . \$7.99

**13** Caster set features 2 front-swivel casters with foot-operated adjusting lever and 2 stationary rear casters. Support up to 400 lbs. Not for use with radial saws (9-19821, 31, 41, 51, 61). Wt. ea. 6 lbs.  
9 R 22221 . . . Set \$44.99  
2 or more . . . Ea. set \$38.24

**14** Caster set features 4 swivel casters with foot-operated adjusting lever. Support up to 400 lbs. Not for use with radial saws (9-19821, 31, 41, 51, 61). Wt. ea. 10 lbs.  
9 R 22222 . . . Set \$54.99  
2 or more . . . Ea. set \$46.74

**15** Caster set features 4 large swivel casters; 2 with foot-operated adjusting levers. For use with radial saws (9-19831, 41, 51). Support up to 400 lbs. Wt. 4 lbs. 8 oz.  
9 R 22254 . . . Set \$54.99

**16** 3-drawer pack for radial saws (9-19831, 41, 51). Incl. 3 Permanex® plastic drawers, 17 1/2 in. long, 16 1/2 in. wide. Incl. 1 each: 3 3/4, 6 1/2, 10 in. deep. Wt. 25 lbs.  
9 R 22253C . . . Set \$79.99

**17** Steel shelf for radial saws (9-19821, 31, 41). Meas. 16 1/2-in. deep, 19-in. long.  
9 R 22251—Wt. 8 lbs. 8 oz. \$24.99

**18** Permanex® plastic door for radial saws (9-19831, 51, 61) resists rust, dents and scratches.  
9 R 22252C—Wt. 4 lbs. 8 oz. \$24.99

**19** Hold-down attachment incl. 2 clamps with 4 adjustable spring holding fingers to hold workpiece firmly. May be used with table saws. Wt. 2 lbs. 10 oz.  
9 R 3230 . . . Set \$13.49

**20** Sawdust collector traps sawdust and wood chips. Includes adapter for collection sawdust from rip cuts, plus wet/dry vac adapter. Fits radial saws sold on p. 140.  
9 R 16995—Wt. 6 lbs. . . \$29.99

Craftsman sawdust collector traps sawdust and wood chips. Includes adapter for collecting sawdust from rip cuts and an adapter to attach wet/dry vacs with 1 1/4-in. and 2 1/2 in. diam. hose. Fits most former radial saws; not for saws sold on p. 140.  
9 R 16997—Wt. 6 lbs. 6 oz. \$24.99

**21** 8-in. diam. buffing wheel has bias-cut edge that stops thread fraying. Industrial-grade 1 1/2-in. wide cotton wheel. 5/8-in. arbor.  
9 R 64941—Wt. 6 oz. . . \$3.79

**22** Carriage return for 10 and 12-in. radial saws except 9-1978, 9-1991, 9-2316, 9-2318, 9-2319, 9-2945. Not for motorized miter saws.  
9 R 29565—Wt. 1 lb. 4 oz. \$29.99

**23** Adjustable height work support table for long or odd-sized pieces of wood adjusts from 25 to 43 in. high. Rollers roll freely in either direction. Locking knob. Can be used with bench power and portable tools. Unassembled.  
9 R 25121—Wt. 6 lbs. 6 oz. \$24.99

**24** Steel floating ring guard helps protect you from sides of blade.  
For 9-2933, 9-2934, 9-2941, 9-2943, 9-2944, 9-1940, 9-1991.  
9 R 29007—Wt. 1 lb. 7 oz. \$19.99  
For 9-2945 and 9-2946  
9 R 29008—Wt. 1 lb. 8 oz. \$34.99

**25** Retractable lower blade guard for (9-1976, 9-1977, 9-1991, 9-1992, 9-19941, 9-1993, 9-2310, 9-2311, 9-2316, 9-1978) and saws sold on page 140.  
9 R 29009—Wt. 1 lb. 1 oz. \$24.99

**26** Helps make square joints even if saw is not perfectly in line. Adjustable pads help hold irregular shapes of molding. For radial saws with 2 3/4-in. depth of cut or more.  
9 R 32056—Wt. 4 lbs. 4 oz. \$20.99

**27** Adjusts from 4x4 to 35x35 in. Incl. 4 adjustable clamps, X-acto® mat cutter and miter square. For radial saws only.  
9 R 32055—Wt. 9 lbs. 7 oz. \$47.99

**28** Sanding drum with 3-inch face lets you do inside contour sanding with your radial saw. Has a medium-grit sanding sleeve over an expandable rubber drum. 2 1/4-in. diameter. For 1/2-20 threaded ends. For use with drill press, order work arbor (9-24645 on p. 99).  
9 R 25246—Wt. 15 oz. . . \$8.99

Sanding sleeves for (28)  
9 R 25221—Fine  
9 R 25222—Medium  
9 R 25223—Coarse  
Shpg. wt. each 1 oz. . . Each \$1.39

**29** Collet chuck lets Craftsman radial saw accept routing or drilling bits with 1/4-in. shank. Fits 1/2-20 threaded accessory ends.  
9 R 3239—Wt. 2 oz. . . \$3.49

**30** Drill chuck converts radial saws into drill. Holds bits with 3/64 to 1/2-in. diam. shanks. Fits 1/2-20 threaded accessory ends. Includes chuck key.  
9 R 2980—Wt. 13 oz. . . \$10.99

Our radial arm saws give you the controlled cutting action needed for high-quality results that live-up to the name CRAFTSMAN!

**DON'T MISS THIS**  
Save on all radial saws on these 2 pages when bought in combination with accessory sets (A) or (B)

CRAFTSMAN manual radial saws feature miter, bevel and rip scales



\$279<sup>99</sup>

10-in. radial saw with max. developed 2½-HP motor has 40x27-in. worktable and steel leg stand

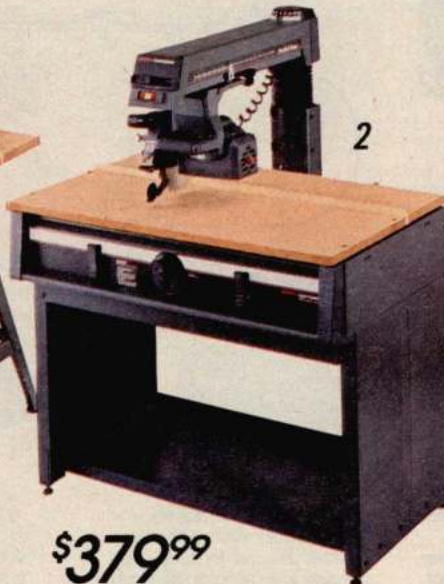

\$379<sup>99</sup>

10-in. radial saw with max. developed 2½-HP motor features a large, 44x27-in. worktable and full-size storage shelf

This 10-in. radial saw with max. developed 2½-HP motor and 44x27-in. worktable boasts 3 convenient drawers and a shelf for extra storage space



\$429<sup>99</sup>

You'll find our complete selection of Craftsman radial saws on these two pages. Since the saw is considered by experts to be the basic power tool of any shop, it should be the first tool acquired when starting or upgrading a workshop. You'll also save if you buy any saw with our Excalibur blade set (A) or accessory set (B) shown on the facing page. All saws are warranted by Sears. Write for free copy, see page 148.

**1 thru 6** All our Craftsman radial saws feature quiet, direct-drive, induction-run ball bearing motors with an automatic blade brake to stop the blade in seconds. Max. rip cap. of 26 in. with a 15½-in. crosscut capacity. They cut wood up to 3 in. thick at 90°; 2¼ in. thick at 45°. 3 fence positions for convenient rip and crosscut set-ups. Fixed miter stops at center, 45° left or right; bevel stops at vertical, 45° and horizontal. Carriage glides on a replaceable steel track so you'll never need to replace the entire arm due to wear. Anti-kickback pawls and spreader help prevent wood binding. Double-end shaft, ⅝-in. arbor. ½-20 thread end accommodates many accessories. Removable locking switch key. 6-ft., 3-wire cord. Work tables are partially assembled. See our Buying Guide Chart below for ordering information.

**1 thru 3** Manual radial saws have rip scales on left and right sides to let you do in or out ripping. All have 10-in. Kromedge steel blades and particle board worktables.

**1** Only \$12 monthly, (see p. 148). Includes sturdy steel leg stand. 120-v.

**2** \$15 monthly, (see p. 148). Includes the largest worktable we offer. Upfront table clamps release makes changing fence position fast and easy. Soft-grip handle. 120-v.

**3** \$16 monthly, (see p. 148). Has 3-piece particle board worktable that's the largest we offer! Upfront table clamps release for easy fence position changes. Soft-grip handle. 3 Permanex® plastic drawers: one ¾-in., one 6½-in., one 10-in. plus shelf with Permanex® door. 120-240-v.

**4 thru 6** Electronic radial saws have LCD readouts that provide accuracy to 1/2° or 0.010 inch! Automatic shut-off increases the life of the "J"-type battery while maintaining memory. Soft-grip handles, particle board tables. 10-in. Kromedge steel blades except (6).

**4** Just \$15 monthly, (see p. 148), this saw has cabinet with one shelf and Permanex® plastic door. 120-v.

**5** \$16 monthly, (see p. 148). Incl. the largest worktable we offer. Upfront table clamps release makes fence position changes easy. Features storage cabinet with full shelf and two Permanex plastic doors. 120-240-v.

**6** \$17 monthly, (see p. 148). Has high-density, worktable with the largest dimensions we offer: 44x27-inches! Has upfront table clamps release for quick fence position changes. 6-drawer unit has two 3¾-in., two 6½-in. and two 10-in. drawers that give you more storage space than any other radial saw we sell. Includes carbide-tipped blade for longer life. 120-240-v.

For your convenience, we've provided this quick-check Buying Guide so you can shop and compare our products with those of competitors. Included are some of the most important features our products offer, to give you the quality you expect from Craftsman.

Item No.	Catalog Number	Table size, in.	Motor max. HP	Table rated HP	Table clamp	Casters	Shpg. wt.	Saw alone
(1)	9 R 19811N	40x27	2½	1½	rear	...	164 lbs.	\$279.99
(2)	9 R 19831N	44x27	2½	1½	up front	...	225 lbs.	379.99
(3)	9 R 19851N	44x27	2¾	1½	up front	...	249 lbs.	429.99
(4)	9 R 19821N	40x27	2½	1½	rear	rear	176 lbs.	379.99
(5)	9 R 19841N	44x27	2¾	1½	up front	...	230 lbs.	429.99
(6)	9 R 19861N	44x27	2¾	1½	up front	yes	278 lbs.	479.99

**A** Excalibur industrial-quality blades have extra-thick carbide tips that provide smooth cuts and long life. 10-in. blades resist gumming, burning and dulling much better than ordinary steel. Fit saws with ⅝-in. arbor. Max. 5500 rpm. Includes 24-tooth rip, 60-tooth crosscut, 50-tooth Master Combination blades. Sold separately, pg. 130.

Blade set combination	Catalog Number	Shpg. wt. lbs.	Sep. prices total	Saw with set
With saw (1)	9 R 19981N	174	\$419.96	\$394.96
With saw (2)	9 R 19982N	232	519.96	494.96
With saw (3)	9 R 19985N	256	569.96	544.96
With saw (4)	9 R 19983N	186	519.96	494.96
With saw (5)	9 R 19984N	237	569.96	544.96
With saw (6)	9 R 19986N	285	619.96	594.96

**B** Radial saw accessory set incl. flexible mask impact goggles with ventilated side shields, 10-in. diam. sanding disc; 2 Kromedge cutter bits (9-3202, 3208); triple-cutter molding head that incl. spacer-washer and wrench; molding head/dado guard which must be used with molding head when saw shaft is in the vertical position. Items sold separately on pgs. 131, 133, 138.

Access. kit combination	Catalog Number	Shpg. wt. lbs.	Sep. prices total	Saw with set
With saw (1)	9 R 19813N	172	\$330.63	\$309.63
With saw (2)	9 R 19833N	232	430.63	409.63
With saw (3)	9 R 19853N	257	480.63	459.63
With saw (4)	9 R 19823N	184	430.63	409.63
With saw (5)	9 R 19843N	238	480.63	459.63
With saw (6)	9 R 19863N	286	530.63	509.63

**Save \$25**

when you buy any radial saw on these two pages in combination with our 3-pc., Excalibur, industrial-quality carbide-tipped blade set!



**Save \$21**

when you buy any radial saw on these two pages in combination with this versatile accessory set



4

**CRAFTSMAN** electronic radial saws have LCD readouts that give you more accurate readings for elevation, rip, bevel and miter than any conventional scale or indicator!



10-in. radial saw with max. developed 2½-HP motor has 40x27-in. worktable and storage shelf with door

**\$379<sup>99</sup>**



5

10-in. radial saw with max. developed 2¾-HP motor has 44x27-in. worktable and a full, 2-door storage shelf

**\$429<sup>99</sup>**

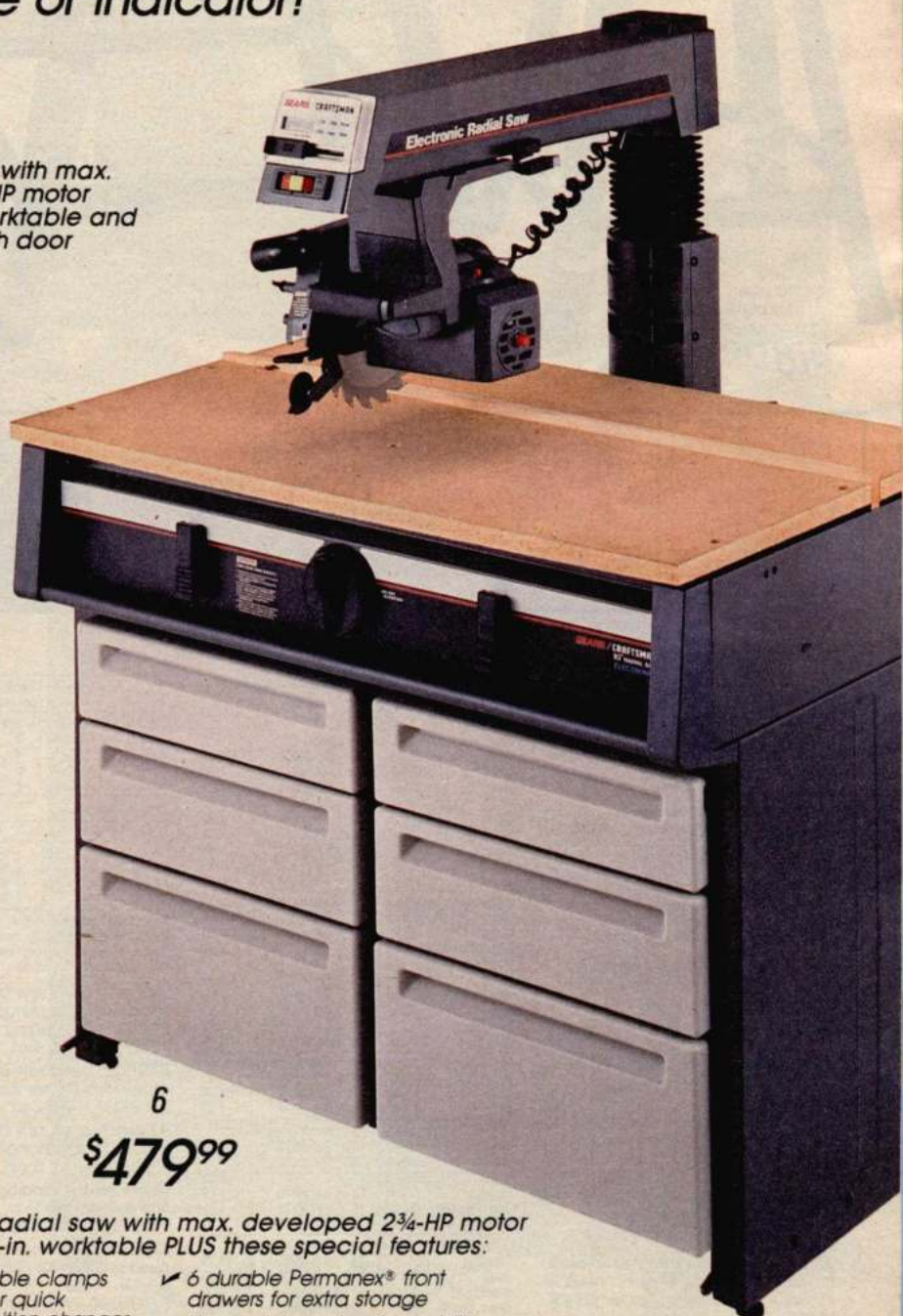

6

**\$479<sup>99</sup>**

Our 10-in. radial saw with max. developed 2¾-HP motor has 44x27-in. worktable PLUS these special features:

- ✓ Upfront table clamps release for quick fence position changes
- ✓ 6 durable Permanex® front drawers for extra storage
- ✓ Heavy-duty casters for mobility



10-in. manual readout band saw... 1/2 HP motor develops maximum 3/4 HP  
**\$189<sup>99</sup>**



12-in. manual readout band saw has 1/2 HP motor that develops maximum 1 HP  
**\$289<sup>99</sup>**



12-in. manual readout band saw with 3/4 HP motor that develops maximum 1 1/2 HP  
**\$389<sup>99</sup>**

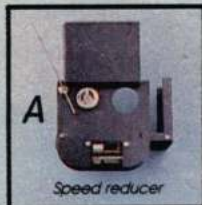

Speed reducer

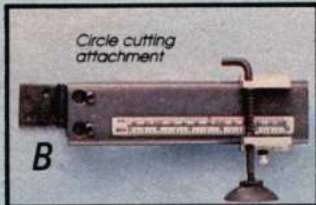

Circle cutting attachment



Miter gauge Rip fences

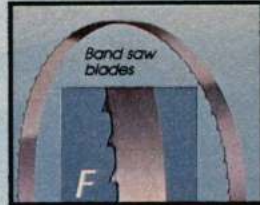

Extension table

## Accessories and replacement blades for band saws

**A** Speed reducer lets you use metal-cutting blades on steel, non-ferrous metals, brass and aluminum. Motor mounts on reducer with bracket and adjusting rod incl. Use with 1725 rpm motor only. Fits most CRAFTSMAN 12-in. band saws except (2), (3) and (4).  
 9 R 23896—Wt. 14 lbs. 1 oz. . . \$139.99

**B** To cut up to 12-in. diam. circles in wood or plastic; also non-ferrous metals.

For saws (2), (3) and (4).  
 9 R 23411—Wt. 1 lb. . . \$22.99

For saws 9-24331, (2), (5), (6) and (7).  
 9 R 24301—Wt. 1 lb. 8 oz. . . \$22.99

**C** Miter gauge fits band saws (1), 9-2444, 24447. Locks at any angle from 0° to 60°.  
 9 R 22574—Wt. 1 lb. 9 oz. . . \$14.99

**D** Rip fences help you make rip cuts evenly.

For saw (1).  
 9 R 23401—Wt. 3 lbs. 12 oz. . . \$24.99

For band saws (2), (3), or (4).  
 9 R 23402—Wt. 5 lbs. 2 oz. . . \$27.99

For band saw 9-24331.  
 9 R 23433—Wt. 3 lbs. . . \$37.99

**E** Extension table attaches to work table side of band saws. 14x22 1/2 in. Solid formed steel. Not for (2), (3), or (4).  
 9 R 24302—Wt. 7 lbs. . . \$32.99

### F Endless band saw blades of tool steel.

For	LxW (in.)	Teeth per in.	Catalog Number	Wt. oz.	Price
<b>Regular-tooth blades for solid wood.</b>					
Wood	56 1/2 x 1/4	6	9 R 26653	2	\$4.99
Wood	62 x 1/4	6	9 R 26641	2	4.99
Wood	62 x 3/8	6	9 R 26642	1	4.99
Wood	72 1/2 x 1/4	6	9 R 26575	3	4.99
Wood*	72 1/2 x 1/4	6	9 R 26576	3	4.99
Wood*	78 x 1/4	6	9 R 26572	3	4.99
Wood	80 x 1/4	6	9 R 26232	3	4.99
Wood	80 x 3/8	6	9 R 26233	3	4.99
Wood	80 x 1/2	6	9 R 26234	5	4.99
<b>Skip-tooth blades... fast cuts in thick woods.</b>					
Wood	56 1/2 x 1/4	4	9 R 26652	2	\$4.99
Wood	62 x 1/4	4	9 R 26646	2	4.99
Wood, Plastic†	72 1/2 x 1/4	4	9 R 26574	4	4.99
Wood	72 1/2 x 3/8	4	9 R 26573	5	4.99
Wood	80 x 1/4	4	9 R 26595	3	4.99
Wood	80 x 3/8	4	9 R 26596	4	4.99
Wood	80 x 1/2	4	9 R 26597	5	4.99
Wood	80 x 1/4	7 1/2	9 R 26577	2	4.99
Wood	72 1/2 x 1/4	7 1/2	9 R 26578	2	4.99
<b>Hook-tooth blades. Pro-quality hard-tooth.</b>					
Wood	80 x 1/4	4	9 R 26585	4	\$6.49
Wood	80 x 3/8	4	9 R 26586	5	6.49
Wood	80 x 1/2	3	9 R 26588	5	6.49
<b>Regular-tooth blades for thin veneer, plastic.</b>					
Wood**	54 x 3/8	15	9 R 26582	2	\$4.99
Wood	56 1/2 x 1/4	15	9 R 26650	1	4.99
Wood	56 1/2 x 3/8	15	9 R 26651	2	4.99
Plywood	62 x 1/4	15	9 R 26645	1	4.99
Thin Plywood	80 x 1/4	15	9 R 26592	2	4.99
Plywood	80 x 1/4	15	9 R 26593	3	4.99
<b>Steel, non-ferrous metal cutting blades.</b>					
Steel**	54 x 3/8	24	9 R 26555	2	\$5.79
Steel	62 x 1/4	14	9 R 26648	2	6.99
Steel**	80 x 1/4	14	9 R 26525	4	7.99
Brass, non-ferrous metals	62 x 1/4	10	9 R 26647	2	4.99
	80 x 1/4	10	9 R 2624	3	4.99

For	LxW (in.)	Teeth per in.	Catalog Number	Wt. oz.	Price
<b>Long-life flame-hardened blades.▲</b>					
Wood	72 1/2 x 1/4	6	9 R 26670	2	\$6.99
Wood	80 x 1/4	4	9 R 26680	3	6.99
Wood	80 x 3/8	6	9 R 26681	3	6.99
Wood	80 x 1/2	6	9 R 26682	4	6.99

For	Width (in.)	Tth./in.	Cat. No.	Wt.	Price
<b>72 1/2 in. blades.▲</b>					
Wood	1/4 in.	15	9 R 26562	2 oz.	\$4.99
Wood	1/2 in.	6	9 R 26564	4 oz.	4.99
Wood	3/4 in.	4	9 R 26566	9 oz.	9.99
Wood	2 in.	2	9 R 26569	2 lbs.	29.99

■ For band saw 9-24391 \*Fine-tooth  
 ▲ Available in Catalog only!

\*\* Must use with speed reducer, see (A).

† Also for chip/hardboard

93 1/2-inch band saw blade▲ is 1/4-inch wide. For Delta (formerly Rockwell) 14-inch wood-cutting band saw.  
 9 R 27193—Wt. 4 oz. . . \$5.99

93 1/2-inch band saw blade▲ is 1/2-inch wide. 15 teeth per inch. For scrolling.  
 9 R 27191—Wt. 2 oz. . . \$5.99

93 1/2-inch band saw blade▲ 1/4-inch wide. 6 teeth per inch. For solid wood.  
 9 R 27192—Wt. 3 oz. . . \$5.99

Replacement sanding belts. Pkg. of 5 fine grit. ea. 80x1/2-in. wide.  
 9 R 22361—Wt. 6 oz. . . Pkg. \$6.79

Replacement sanding belts for 10-inch band saw 9-2442. Pkg. of 5 fine grit, ea. 62x1-in. wide.  
 9 R 25064—Wt. 6 oz. . . Pkg. \$6.29

1 thru 4 Craftsman® band saws feature built-in sawdust ejection, plus a channeling system with a 2 1/2-in. opening for attaching a wet/dry vac (see p. 119)—lets you vacuum away sawdust as you work. The saws also accept sanding belts, allowing them to be used as belt sanders. Lightweight aluminum wheel rotates on smooth-running ball bearings. A simple control knob adjusts blade tension. (2 thru 4) feature Sears exclusive built-in work light, cast aluminum frames, belt-driven 80-in. blades and metal blade guides. Warranted by Sears. Write for free copy, see p. 148.

1 \$10 monthly▲. Manual readout band saw has tubular steel frame and 14x12 1/2-in. cast aluminum work table. Single-speed direct drive motor and plastic blade guide. Uses 72 1/2-in. blade. Includes leg set.  
 9 R 24711N—Wt. 71 lbs. . . \$189.99

2 \$13 monthly▲. Manual readout band saw features tilt-head design, 23x18-in. cast aluminum work table and steel leg set.  
 9 R 24721N—Wt. 130 lbs. . . \$289.99

3 \$15 monthly▲. Our most powerful manual readout band saw has tilt head, 23x27-in. cast aluminum work table and open storage cabinet with shelf.  
 9 R 24731N—Wt. 145 lbs. . . \$389.99

4 \$16 monthly▲. Our finest band saw has all the features shown on opposite page, plus a storage cabinet with door and shelf that provides plenty of extra space for accessories.  
 9 R 24741N—Wt. 149 lbs. . . \$439.99

▲ See page 148.

# Presenting our complete line of CRAFTSMAN® band saws



Band saws (2), (3) and (4) have our exclusive tilt-head that lets you make bevel cuts from 0° to 45° while your workpiece remains on a flat surface



Our finest 12-inch band saw has a 2-speed,  $\frac{5}{8}$ -HP motor that develops a maximum  $1\frac{1}{8}$  HP. Includes these outstanding features:

- ✓ Digital display provides accurate readouts for blade speed (fpm), blade tension and blade angle. Angle settings accurate to  $\frac{1}{2}^\circ$
- ✓ Sears exclusive stationary work table that provides a huge 23x27-inch work surface
- ✓ 6-inch depth of cut is largest of any saw we sell
- ✓ 2-speed motor provides a speed for basic woodcutting, plus a reduced speed for non-ferrous metals, veneers, plastics and tile
- ✓  $\frac{1}{2}$ -inch wide sanding belt converts your band saw into a belt sander
- ✓ Sears exclusive built-in work light helps improve eye contact with cutting line

## \$439<sup>99</sup>

# SEARS SHELVING SHOP . . . the place for keeping Heavy-duty units with side and back bracing for extra stability



**DON'T MISS THIS!**  
Even our standard weight utility shelving is braced for stability  
**\$949**

Keep your basement or utility room neat with our standard weight utility shelving. The 4 steel shelves are adjustable in 1/4-in. increments. Gray enamel finish heavyweight steel posts. Silver color, pebble grained finish shelves. Overall dimensions are 12Dx30Wx60 inches high. Shipped unassembled, instructions included. Shpg. wt. 11 lbs. 12 oz. 9 R 62071C . . . \$9.49



**2**  
5-shelf unit(2)  
**\$1899**



**3**  
Extra deep 5-shelf unit(3)  
**\$2399**



Extra capacity 8-shelf unit(4)  
**\$2999**

2 thru 4 Ideal for workshop or garage storage needs, these heavy-duty shelving units are made of heavyweight steel with back and side bracing for extra stability. Shelves adj. in 1/4-in. increments and reverse to form a 1-in. lip to help prevent items from sliding or rolling off. Units are designed to be bolted together, if desired, to form a larger storage unit. Plastic end caps keep posts from scuffing up the floor. Baked-on enamel finish. Unassembled, instructions incl.

Key	No. of shelves	Dimensions DxWxH-in.	Catalog Number	Wt. lbs.	Price
(2)	4	12x30x60	9 R 62081C	13	\$13.99
(2)	5	12x36x70	9 R 62083C	19	18.99
(3)	5	16x36x70	9 R 62085C	22	23.99
(4)	8	12x30x60	9 R 62082C	20	29.99

Extra shelves for heavy-duty units above. Pkg. of 2 shelves. Order shelves with the same depth as shelving unit.

Dimensions DxW-in.	Catalog Number	Shpg. wt.	Price, pkg.
12x30	9 R 62842C	4 lbs. 8 oz.	\$9.99
16x36	9 R 62843C	8 lbs. 8 oz.	12.99



**New at Sears!** The library wall stores books and mementos in an expansive 7 1/2-ft. long display that highlights any room in your home

**\$3999**

5 A beautiful addition to any room in your home, this shelf storage unit highlights your favorite books, records, trophies or mementos on 12 classically patterned, walnut woodgrain finish steel shelves which blend in with just about any decor. Unit is divided into 3 separate sections which are bolted together to form wall unit. Each 4-shelf section is 36Hx30Wx12D-in. Heavyweight black steel posts have plastic end caps to prevent marring. Unassembled, instructions, hardware included. 9 R 62053N—Shpg. wt. 29 lbs. . . \$39.99



Classic Walnut-look shelving units **\$1399 and up**

6 Add a touch of class to any room with these shelving units that coordinate with just about any decor. Rich, simulated woodgrain finish is accented with sleek black posts. Durable steel construction. Specially designed "share-a-post" construction enables you to join units together to form a wall of shelves. Shelves are 30Wx10D in. Adjustable in 1/2-in. intervals. Unassembled, instr. incl.  
3-shelf unit. 30Hx30Wx10D-in. 9 R 62941C—Wt. 7 lbs. 14 oz. \$13.99  
4-shelf unit. 36Hx30Wx10D-in. 9 R 62942C—Wt. 9 lbs. 14 oz. \$18.99



Panel and shelf enclosure kit for (3) keeps everything organized

7 and 8 Fits units with 16x36-in. shelves. Hardboard panels fully enclose 36x16x22 1/2-in. high opening. Hardware, instr. included.  
7 Sliding door cabinet fully encloses shelf with 2 doors, 2 side panels, back panel. Sliding tracks, pulls incl. 9 R 62833C—Wt. 9 lbs. 8 oz. Kit \$9.99  
8 Drop-leaf closure has lockable steel door with hasp for padlock (not incl.) to restrict access. Hardboard side panels. Fully enclosed. Wt. 10 lbs. 6 oz. 9 R 62832C . . . Kit \$19.99  
Panel closure kit shown with (7) keeps items from falling off sides, back of shelf. Encloses 2 shelves with 2 back and 2 side panels. Wt. 11 lbs. 8 oz. 9 R 62831L . . . Kit \$14.99

your home, shop, garage or business better organized!



**Commercial-quality all-steel shelving**

22-gauge steel shelving (not shown) has 16-gauge steel posts. Sides and back are braced for rigidity. "Kwik Klip" fasteners adjust shelves without disassembly. Rust-resistant, gray baked-on enamel finish. Shelves adjust in one-inch increments. Units measure 75 in. high. Extra shelves are available; order below. See shipping note below, left. Unassembled.

Size (inches)	No. of shelves	Catalog Number	Shpg. wt.	Price
120x36W	5	F 9 R 7492N	47 lbs.	\$42.99
120x36W	6	F 9 R 74940N	53 lbs.	44.99
180x36W	5	F 9 R 7493N	60 lbs.	54.99
180x36W	6	F 9 R 7495N	68 lbs.	62.99
240x36W	6	F 9 R 7496N	75 lbs.	79.99

Extra shelves for units above are 22-gauge steel. 36 inches wide. Package of 4 shelves, 16 Kwik Klips. Order same depth as your shelf unit. See Note below.

Depth	Catalog No.	Shpg. wt.	Package
12 inches	F 9 R 7497N	22 lbs.	\$21.99
18 inches	F 9 R 7498N	30 lbs.	29.99
24 inches	F 9 R 7499N	34 lbs.	39.99

You can really pile it on with Sears Best non-commercial shelving units. Just look at all the outstanding features above and you'll see why we believe they're the best. Sturdy, heavyweight steel shelves and posts have a durable baked-on black enamel finish accented by brass-plated hex nuts and bolts for an attractive, modern "hi-tech" appearance. Shelves adjust in 1½-in. increments. Plastic end caps and floor guards help prevent marring. Unassembled. Hardware, wrench and instructions included. 5-shelf unit is 18x36x72 in. high. 9 R 62093C—Wt. 36 lbs. . . \$37.99 Larger 5-shelf unit has deeper shelves for increased storage. 24x36x72 in. H. 9 R 62096C—Wt. 46 lbs. . . \$47.99 SHIPPING NOTE: Unavailable. Allow 14 days for delivery. Contact Sears selling unit for shipping and handling charges. No C.O.D. orders.

Our best utility shelving units hold more weight than any other consumer units we sell because of these EXCLUSIVE FEATURES:

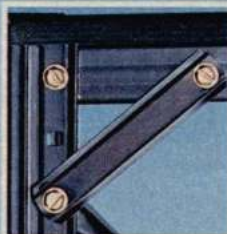

✓ Four reinforcing brackets (gussets) provide additional support at key stress points

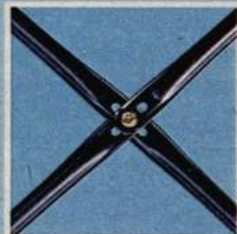

✓ Double "X" bracing on back provides extra stability. Single "X" bracing on sides help prevent swaying



✓ Rust-resistant, brass-plated hex nuts and bolts for ease of assembly

- ✓ Ideal for storing and organizing heavy items such as boxes of laundry detergent, paint cans, potting soil, automotive supplies and power tools
- ✓ Extra heavyweight steel shelves and posts support more weight than our other non-commercial shelving

**\$37<sup>99</sup>** and up

Industrial shelving units handle just about all your storage needs

**\$59<sup>99</sup>** and up

- ✓ Heavy duty 20-ga. steel shelves and 13-ga. steel posts provide greater support for heavy objects
- ✓ Box-formed on all sides for strength. Back and side braces prevent swaying
- ✓ Kwik Klip shelf fasteners let you remove, add or adjust shelves without disassembly

2 Industrial shelving has rust-resistant, gray baked-on enamel finish. 85 in. high. Shelves are adjustable in 1-in. increments. Unassembled. Order from chart below. Shipped directly from factory, see shipping note below, left.

Size (inches)	No. of Shelves	Catalog Number	Shpg. wt.	Price
120x36W	5	F 9 R 7400N	75 lbs.	\$59.99
120x36W	6	F 9 R 74010N	77 lbs.	59.99
120x36W	8	F 9 R 74020N	99 lbs.	74.99
120x48W	5	F 9 R 7403N	88 lbs.	71.99
120x48W	6	F 9 R 7404N	90 lbs.	79.99
120x48W	8	F 9 R 7405N	118 lbs.	99.99
180x36W	5	F 9 R 7406N	92 lbs.	72.99
180x36W	6	F 9 R 7407N	104 lbs.	79.99
180x36W	8	F 9 R 74080N	125 lbs.	89.99
180x48W	5	F 9 R 74090N	102 lbs.	79.99
180x48W	6	F 9 R 74100N	116 lbs.	89.99
180x48W	8	F 9 R 7411N	147 lbs.	119.99
240x36W	5	F 9 R 7412N	110 lbs.	85.99
240x36W	6	F 9 R 7413N	115 lbs.	97.99
240x36W	8	F 9 R 7414N	169 lbs.	119.99
240x48W	5	F 9 R 7415N	136 lbs.	104.99
240x48W	6	F 9 R 7416N	142 lbs.	119.99
240x48W	8	F 9 R 7417N	196 lbs.	152.99

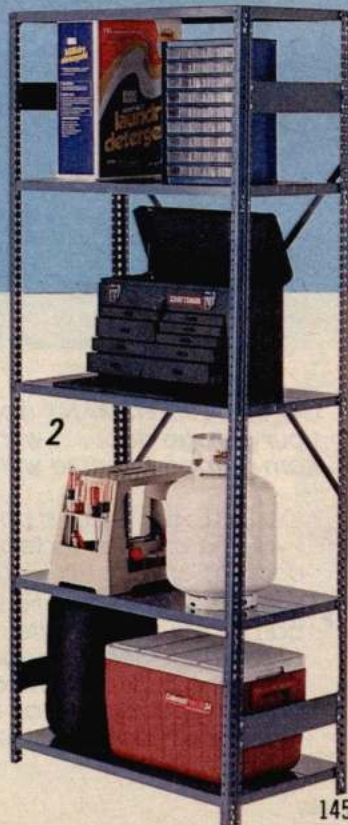

Look at these features... they're the ones you want! That's why... since 1984,  
**WE'VE OPENED MORE GARAGE DOORS  
 THAN ANYONE ELSE IN AMERICA!**

- ✓ Powerful steel chain/cable drive for dependable, reliable service
- ✓ Easy-to-change private security codes help prevent unauthorized use
- ✓ Time-proven and tested control mechanism give years of dependable, trouble-free service
- ✓ Door automatically reverses directions if path is obstructed upon descent
- ✓ 4½ minute light delay lets you gather children and packages and safely exit lighted garage
- ✓ Door may be used manually during power outages and reconnects automatically when power is restored



Turn on porch lights...



yard lights...



or house lights at a push of the button

**Our Best CRAFTSMAN® opener gives you more features! Not only will it open your garage door... with optional light control receivers, it'll light your way from garage to home without your leaving the comfort and security of your car!**

**\$214<sup>99</sup>** opener alone  
 \$11 Monthly†

- ✓ Our Best opener has a powerful ½-HP motor that handles garage doors as large as 18x7½-ft.
- ✓ Over 19,000 security codes for added protection against unauthorized use
- ✓ Solid-state three-function transmitters can be used to operate up to three 19,683-code Sears garage door openers independently. With the optional light control receivers sold on facing page, turn on inside and outside lights
- ✓ Independent worklight control lights garage without opening garage door
- ✓ Vacation/security switch deactivates opener over extended periods of time
- ✓ Lighted wall-mount receiver operates opener from inside garage

†See p. 148.

Based on units sold 1984 to present.

**1 thru 5** With all 6 of these super features, isn't it about time you let our garage door openers work for you? Avoid back strain and inclement weather with a simple push of a button on the solid-state transmitter. Steel chain/cable drive is connected to powerful motor for a dependable system designed for years of service. Steel housing. Openers comply with FCC rules, part 15. Check local codes. Imported. See warranty, liability notes below.

**1** Our best opener has two 3-function solid-state transmitters that can be used with the optional light control receivers sold at the right, to turn on house lights as easily as opening your garage door. Ideal for twin or multi-door garages. 19,683 codes per channel for extra security. Twin light lens. Limited 5-year motor parts warranty, see below. 9 R 53513C—Wt. 46 lbs. . . \$214.99

**2** \$10 monthly. † CRAFTSMAN premium opener has one 3-function transmitter. Similar construction, motor parts warranty to (1) except has no security/vacation switch or independent worklight. Single light lens. Extra transmitter, accessories sold at right. 9 R 53413C—Wt. 44 lbs. . . \$184.99

**3** \$10 monthly. † Sears better opener lifts doors as large as 18x7½-ft. with its powerful ½-HP motor. Lighted push-button wall mount control. 2000 code single function transmitter. Enclosed light with diffuser. 9 R 53310C—Wt. 44 lbs. . . \$174.99

**4** Sears good opener has ½-HP motor that handles garage doors as large as 18x7½-ft. Push-button wall mount control. Single function transmitter has 2000 security codes. Enclosed light with diffuser. 9 R 53210C—Wt. 44 lbs. . . \$144.99

**5** Sears budget opener has ¼-HP motor. Lifts doors as large as 9x7½-ft. Push-button wall mount control. Single light socket (bulb not included). 9 R 53110C—Wt. 44 lbs. . . \$124.99

**FULL 90-DAY WARRANTY ON GARAGE DOOR OPENER.** For 90 days from date of purchase, Sears will repair any defect in material or workmanship at no charge.

**LIMITED WARRANTY:** From the 91st day until 1 year from date of purchase. Sears will furnish replacement parts for any defective parts, free of charge. You pay for labor.

**LIMITED WARRANTY ON MOTOR FOR CRAFTSMAN OPENERS:** After 1 year and through the number of years specified, Sears will furnish replacement parts for any defective parts in motor, free of charge. You pay for labor.

**LIMITATION ON LIABILITY:** Sears will not be liable for loss or damage to property or any incidental or consequential loss or expense from property damage due directly or indirectly from the use of this product. Some states do not allow the exclusion or limitation of incidental or consequential damages, so the above limitation or exclusion may not apply to you. This warranty does not cover repairs necessary because of operator abuse or negligence, including failure to install, adjust and operate the opener according to instructions contained in owner's manual. Warranty service is available by contacting the nearest Sears store or Service Center in the U.S. This warranty gives you specific legal rights and you may also have other rights which vary from state to state.

† See p. 148.

## Update CRAFTSMAN or Sears openers and add even more versatility

From the security of your home, this 3-channel household transmitter, with the proper receiver can turn on interior or exterior lights at the touch of the button

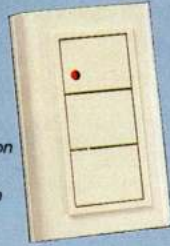

Light control receivers **\$19<sup>99</sup>**



Just screw into bulb receptacle. Ideal for dark stairways, passageways

Wires into a 2 or 3-way switch like a dimmer for controlling interior, exterior lights



Plug-in unit uses outlet to operate interior lights



**6 thru 9** From the convenience and security of your home or car, just a simple push of a button turns on lights or opens your garage door. You don't have to fumble for the switch when entering darkened rooms or hallways or leave the lights on all the time.

**6** 3-function household transmitter, when used with receivers below, can turn on lights as well as operate garage door openers. May be mounted on wall with bracket included or carried. Operates any 53000 series Sears garage door opener with 19,683 codes. Complies with FCC rules, part 15. 9 R 53720—Shpg. wt. 6 oz. . . \$29.99

**7** Screw-in receiver fits standard bulb receptacle. No wiring needed. Use maximum 150-watt incandescent bulb or par lights. 9 R 53723—Shpg. wt. 6 oz. . . \$19.99

**8** Wire-in receiver takes place of wall switch in any 2 or 3-way lighting operation. Use maximum 500-w. incandescent bulb or par lights. 9 R 53722—Shpg. wt. 6 oz. . . \$19.99

**9** Receiver plugs into wall outlet. Appliance cord plugs into receiver. Takes maximum 150-watt incandescent bulb. 9 R 53724—Shpg. wt. 6 oz. . . \$19.99

**10** Single function digital control transmitter for use with any 53000 series opener. Imported. 9 R 53708—Shpg. wt. 5 oz. . . \$29.99

**11** Convenient pocket-sized single-function transmitter can be used with opener or light control receivers. 9 R 53738—Shpg. wt. 2 oz. . . \$29.99

**12** 3-function car transmitter alone. Use with all 53000 series Sears openers with 19,683 security codes. Shpg. wt. 2 lbs. 2 oz. 9 R 53718 . . . \$29.99

Transmitter for Sears openers with 512 codes. Imported. Specify "Y" or "S" from present transmitter or receiver. 9 R 53706—Shpg. wt. 5 oz. . . \$34.99

Transmitter for all openers with 3375 codes. Imported. 9 R 53707—Shpg. wt. 5 oz. . . \$34.99

**13** Garage door sensor uses invisible light beam to reverse door before hitting obstruction. Imported. 9 R 53710—Wt. 2 lbs. 2 oz. . . \$19.99

Garage door extension kit for Sears, Craftsman openers fit oversize doors.

Door height	Catalog Number	Shpg. wt.	Price
8-ft.	9 R 53704C	8 lbs.	\$29.99
10-ft.	9 R 53705L	18 lbs.	49.99



Key chain single function transmitter **\$29<sup>99</sup>**



Garage door sensor system uses invisible beam of light to detect objects in door's path and reverses door before hitting obstruction.

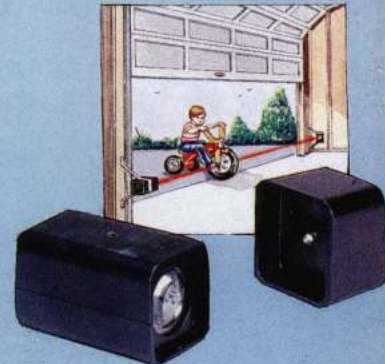

CRAFTSMAN Premium garage door opener turns on house lights as you open your garage door **\$184<sup>99</sup>**



Sears better opener offers a ½-HP motor with over 2000 security code combinations **\$174<sup>99</sup>**

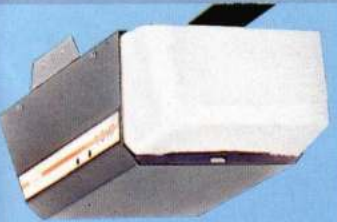

Sears good opener has ½-HP motor and over 2000 security codes **\$144<sup>99</sup>**



Sears budget opener has ¼-HP motor and multiple security codes **\$124<sup>99</sup>**

FOR OVER 60 YEARS AMERICA'S TOOL USERS HAVE COUNTED ON FAMOUS CRAFTSMAN QUALITY. NOW WE SAY "THANK YOU" BY OFFERING OUR TOOL BOOK CUSTOMERS THIS EXCEPTIONAL VALUE!

Our CRAFTSMAN®  
2.0-HP 12-gallon  
Wet/Dry Vac  
with a 5-piece  
Accessory  
Kit

For the  
great low price of

**\$97<sup>99</sup>**



Vac with  
Accessory Kit  
plus Tote

**\$107<sup>99</sup>**



Judge for yourself . . . can you buy a better wet/dry vac anywhere else? This Vac's powerful motor generates suction power strong enough to do all this and more!

- ✓ Picks up 3 gal. of water in only 3 sec!
- ✓ Picks up 13 lbs. of pea gravel in 15 sec!
- ✓ Picks up 1/2 bushel of sawdust in only 23 sec!
- ✓ Handles wet and dry spills at the same time!
- ✓ Automatic suction shut-off during liquid pickup helps prevent overflows!
- ✓ Washable, reusable cartridge-type filter remains in vac for both wet and dry pickups!

When you need more than just a vac, depend on this one to clean up just about everything from minor kitchen spills to muddy floors. Picks up almost any debris that will pass thru the hose. Generates powerful suction thru high-efficiency blower wheel and patented air venting system. Converts to a blower when you place hose in exhaust port, making it ideal for blowing debris out from under furniture or those other hard-to-reach areas around bench power tools or workbenches. Can also quickly dry wet floors.

12-gallon tank of dent and rust-resistant polypropylene rolls on casters for easy mobility. Includes 7-ft., 2 1/2-in. diam. hose, utility nozzle, 2-pc. extension wand, wet nozzle, car nozzle, crevice tool. Drain. 15-ft. cord. Approx. 26x19 in. diam. Warranted by Sears, write for free copy, see right. 9 R 17964L—Shpg. wt. 24 lbs. . . . Outfit \$97.99

Vac outfit above with Permanex® polypropylene tote. 9 R 17965L—Shpg. wt. 27 lbs. . . . Outfit \$107.99

**HELPFUL INFORMATION ABOUT YOUR SEARS CATALOG ORDER**

YOU AUTOMATICALLY GET THE LOWER PRICE if the item you order is currently on sale in another Sears Catalog.

REGARDING OUR CATALOG PRICES: Prices quoted in Sears catalogs do not include (unless stated otherwise) charges for handling and shipping of goods to you. These charges may differ depending on method of shipping. Information on how shipping weights are determined and details on charges for shipping by USPS/UPS or non-Sears truck can be obtained from the information pages of our General Catalog. Specific details on charges for handling and shipping to a Sears Catalog Unit for pick-up or redelivery (if available) can be obtained from the unit. Catalog merchandise prices and assortments may vary from those in our Retail Stores.

"N", "NH" suffix (such as 9-1234N) means that the item if shipped directly to your home, is sent by motor carrier. (See shipping information pages in our General Catalog.)

COPIES OF WARRANTY STATEMENT: A warranty is included with any product covered by a specific written warranty. If you wish a copy before you order, please state catalog number, page number in catalog, description of product and manufacturer's name, if mentioned. Address your request to: Warranty Information, Department 698/731A, Sears, Roebuck and Co., Sears Tower, Chicago, IL 60684

SEARS HAS A CREDIT PLAN TO SUIT MOST EVERY NEED. SEE GENERAL CATALOG OR ASK FOR DETAILS.

IF YOU HAVE AN EXISTING SEARSCHARGE OR SEARSCHARGE PLUS ACCOUNT BALANCE, the addition of a specific purchase may or may not change your current monthly payment depending upon the highest balance of your account. Sales Tax, delivery or installation charge, if any, may cause quoted minimum monthly payments to be higher.

**HOW TO GET SEARS CATALOGS AUTOMATICALLY**

Just place at least two orders of \$30 or more each, every six months from any Sears catalog and you will be offered our General Catalogs free of charge, plus many sale catalogs throughout the year.

**OUR ANNUAL CATALOG HAS MORE**

You'll find our most complete selection of home improvement items and automotive equipment in our Annual Catalog