

OPERATION INSTRUCTIONS & PARTS

DIVIDING HEAD B & S Type

No. 0, No. 1 and No. 2

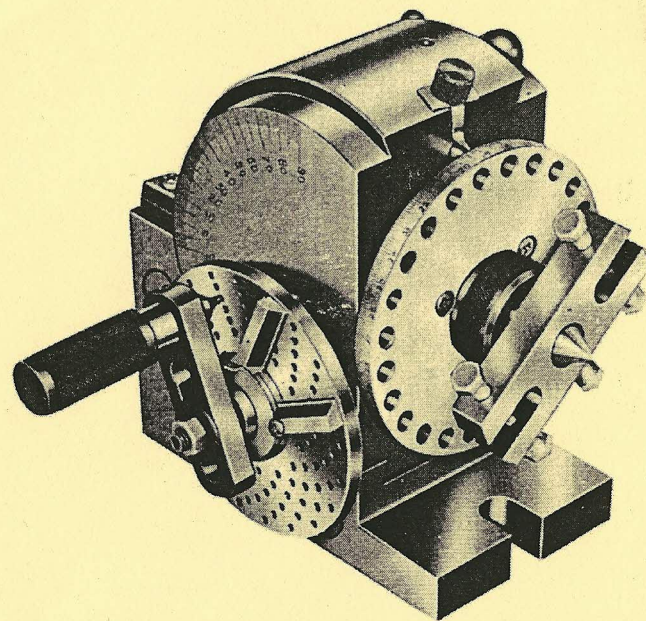
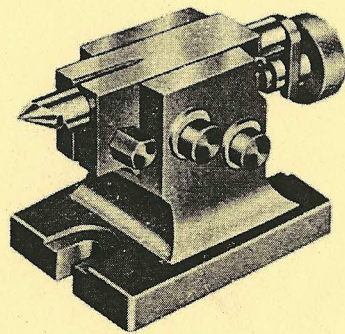
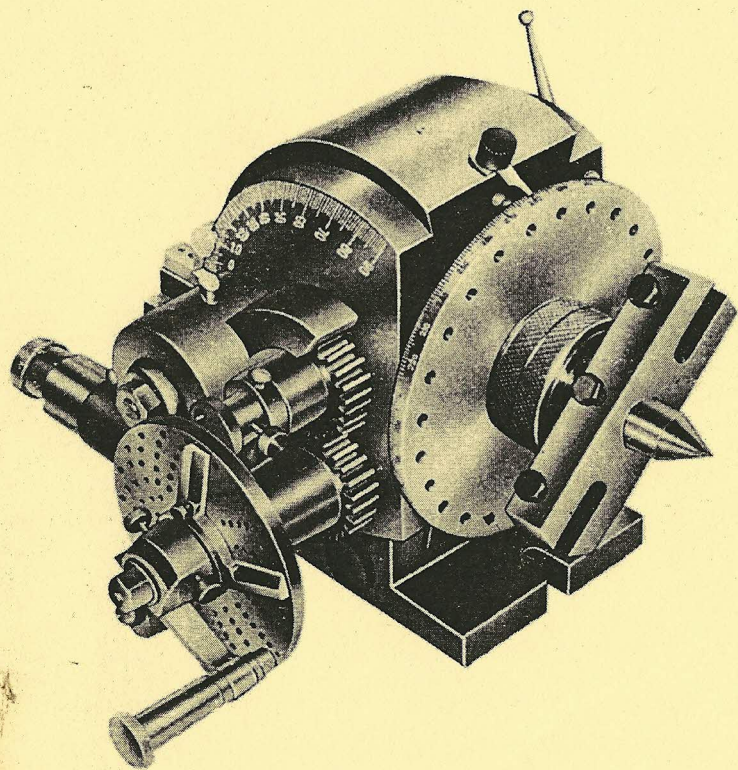

OPERATION INSTRUCTIONS

DIVIDING HEAD B & S Type

These heads are suitable for milling grinding and drilling work. A plain dividing plate with 24 notches gives direct divisions of 2, 3, 4, 6, 8, 12 and 24. By indirect indexing (worm gear ratio 1:40) all divisions up to 50 and many above 50 can be carried out (see indexing chart). Divisions beyond the indirect indexing range are obtained by using the differential system which gives all divisions up to 1000. The indexing chart supplied with each head lists all divisions up to 380. Spiral milling work can also be carried out with BS-2 dividing heads.

Construction: These attachments combine rigidity with accuracy. The indexing spindle runs in precision taper roller bearings virtually free of play. In contrast to conventional designs the direct indexing plate is mounted at the tapered front indexing spindle. Dividing head and indexing spindle can be swivelled from horizontal to vertical. Indexing spindle, worm, direct indexing pin are hardened and ground, as well as centers and indirect indexing pin. The wormwheel is made of a special hard phosphor-bronze. Worm and wormwheel as well as most of the other revolving parts rotate in oil.

ENCLOSURE:

1. Fixed tailstock
2. Carrier
3. Center for head and tailstock
4. Direct indexing plate with 24 notches
5. Indirect indexing plate with 18 circles of holes 15-49.
 - A 15, 16, 17, 18, 19, 20
 - B 21, 23, 27, 29, 31, 33
 - C 37, 39, 41, 43, 47, 49
6. 12 change gears for differential and spiral milling. (only BS-2)
7. Change gear quadrant and 2 bolts (only BS-2)
8. Flange plate,
9. Test certificate
10. Operating instructions
11. Indirect dividing table
12. Differential dividing table (only fitting BS-2)
13. Table for spiral milling (only fitting BS-2)

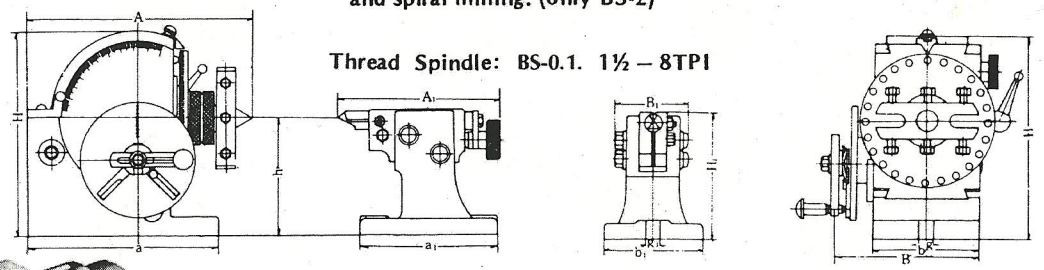
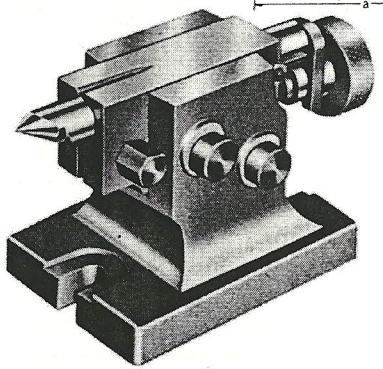
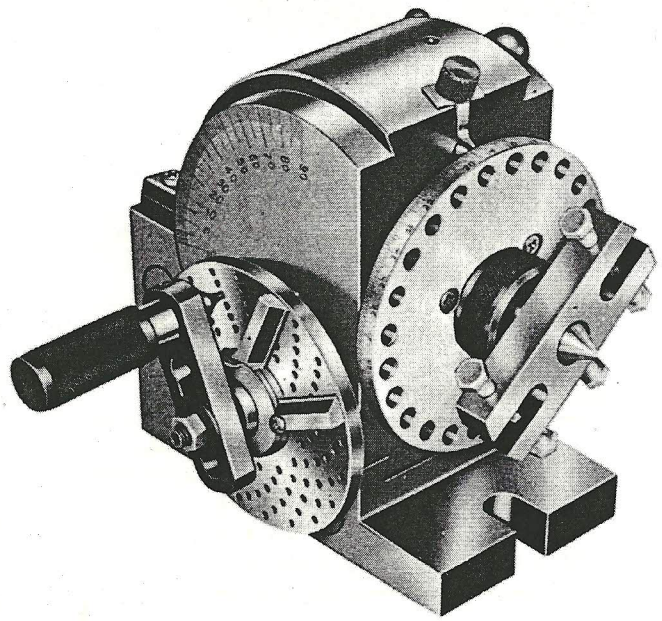

Thread Spindle: BS-0.1. 1 1/2 - 8TPI

Semi-Universal Index B & S Type No. 0 No. 1 (Head-stock)

No.	mm in	A	B	H	h	a	b	g	Taper of center	Diameter of spindle hole
BS-0		189 7 7/16	140 5 3/4	173 6 13/16	100 3 15/16	160 6 19/64	91 3 37/64	13 33/64	B & S No.7	18
BS-1		293 11 17/32	156 6 3/4	220 8 21/32	128 5 3/4	207 8 5/32	114 4 3/64	16 5/8	B & S No.9	20

Semi-Universal Index B & S type No.0 No.1 (Tail-stock)

No.	mm in	A ₁	B ₁	H ₁	h	a ₁	b ₁	g
BS-0		167 6 37/64	80 3 5/32	107.5 4 15/64	100 3 15/16	130 5 1/8	92 3 3/8	13 33/64
BS-1		191 7 33/64	88 3 15/32	137 5 3/64	128 5 3/4	150 5 23/32	108 4 1/4	16 5/8

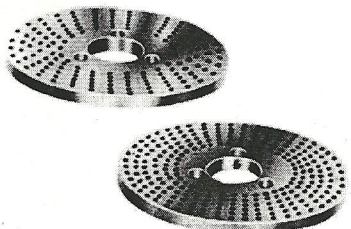
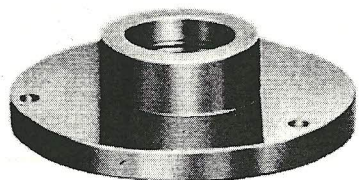

Universal Dividing Head

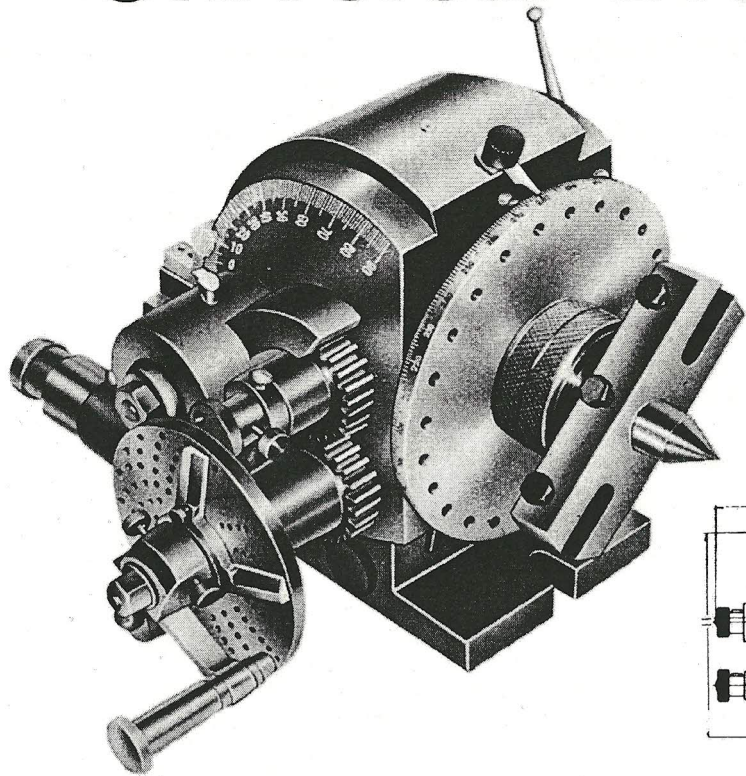

ACCESSORIES:

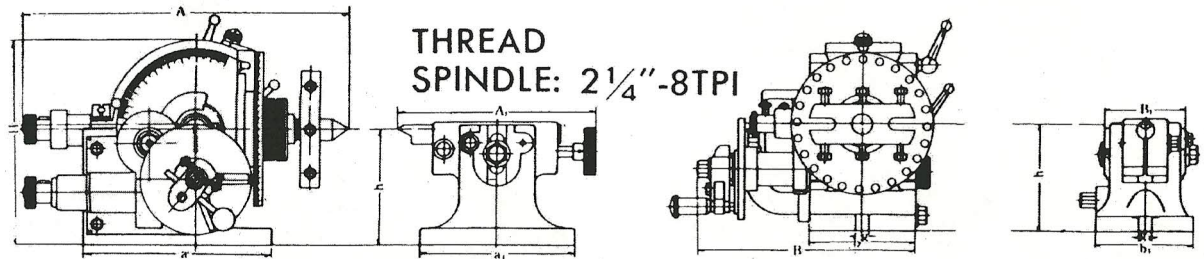
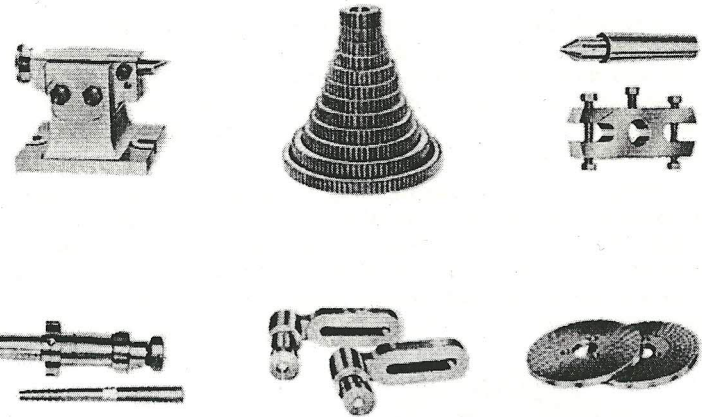

Universal Index B & S type No.2 (Head-stock)

No.	mm		A	B	H	h	a	b	g	Taper of center	Diameter of Spindle hole
	in										
BS-2	365	272	236	132.7	213	134	16	B & S No.10	25.4	I	
	14 1/32	10 9/64	9 1/64	5 1/4	8 3/4	5 1/2	5/8				

BS-2 (Tail-stock)

No.	mm		A ₁	B ₁	H ₁	h	a ₁	b ₁	g ₁
	in								
BS-2	205-255	88	139	132.7	175	124	16		
	8 5/64 ~ 10 3/64	3 1/32	5 1/2	5 1/4	6 3/4	4 7/8	5/8		

Operation

The indexing attachment is a precision instrument and should, therefore, be handled with care. After unpacking, remove anti-rust compound.

Before setting up the head on the machine table, both the table surface and the base of the dividing head must be free of dirt and chips in order to obtain maximum accuracy.

Maintenance

A continuous maintenance i.e. lubrication is necessary. Special care should be taken in direct indexing operations, that the holes of the direct indexing plate and the direct dividing index are absolutely clean, as even a slight contamination of these parts results in indexing faults. Just two lubrication point has to be oiled.

Adjustment of worm backlash

Any backlash between worm and worm wheel encountered after extensive operation is removed as follows:

1. Loosen locking bolt and turn the stop screw so far until worm backlash has been taken out. In this respect however, a free turning of the hand crank should still be possible.
2. Tighten locking bolt.

The worm backlash has been removed when no more play can be observed on the index head spindle.

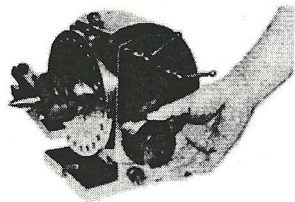

BS-2

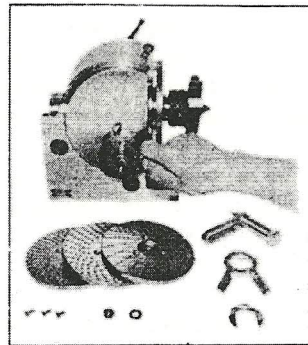

BS-0.1.

Direct indexing

Swivel out the worm. For further indexing, loosen the spindle locking and lift out the direct dividing index with the respective lever. The indexing spindle can then be turned by the desired number of holes, after which the direct dividing index is engaged again. In the case of relatively heavy work tighten the spindle locking as well. The standard equipment includes a holes plate with 24 holes.

Rule: Divide 24 by the number of divisions required and the result equals the number of holes to move in the 24-hole rapid index plate. Thus, number of holes to move = $24/D$, where D is the number of divisions.

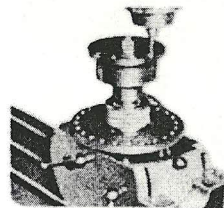

Indirect indexing

In this case swivel the worm carefully to the stop by means of the swivel lever, at the same time turning slightly the indexing spindle and then the hand crank. Disengage the direct dividing index. Operate clamping device for hole plate.

Then take the following steps:

1. Look up circle of holes in the indexing table. If the particular circle of holes is not visible on the index plate, remove hand crank and indicator bracket, remove index plate after loosening of holding screws and screw it on again in reversed form. (The circles of holes stated are distributed over both sides of the index plate).
2. Adjust indicator bracket after loosening of locking screw in such a way that the number of holes which is also shown in the table remains uncovered between the legs.
3. Tighten locking screw
4. After loosening of central nut shift hand crank in such a way that the index pin can engage in a hole of the desired circle of holes. Do not disalign hand crank! After tightening the central nut, it must be possible to engage the index of the hand crank in every desired hole of the circle.
5. Then engage the index of the hand crank in the starting position and turn the indicator bracket in indexing direction until the index lies flush to the inside of the second indicator leg. (Note: If a + is shown behind the number of holes in the table, move the indicator bracket in the direction opposite to indexing until it contacts the index).
6. For further division disengage the index, turn the hand crank until the index can engage in the last hole before the second indicator leg.
7. If, by accident, the index has passed over the intended hole, the handle has to be turned back for several holes in order to engage the index in the right hole by turning the handle again in clockwise direction.
8. Clamp the indexing spindle for heavy work.

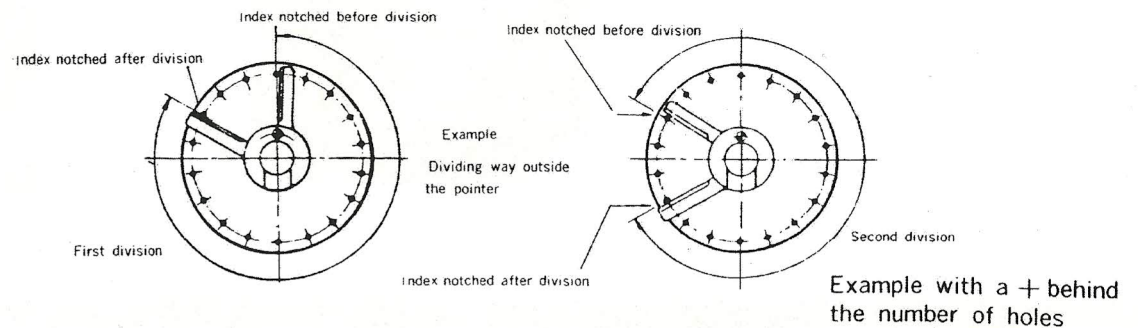
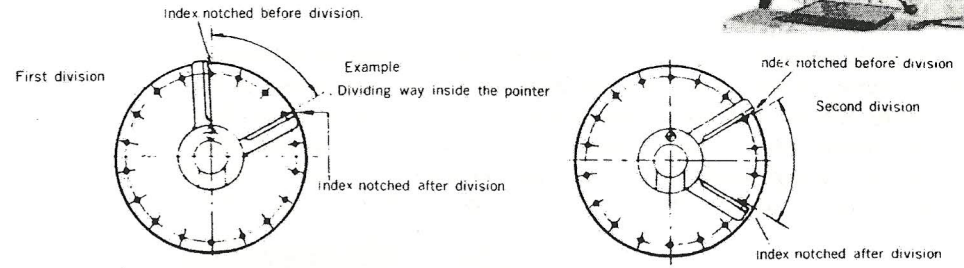
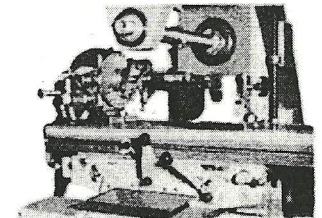

Example: Divisions $D = 9$. Then $T = 40/9$, or 4 turns plus $4/9$ turn. Multiply the fraction by a suitable number, say 2. Then $4/9$ becomes $8/18$. Since you have an 18-hole circle, you will index 4 turns plus 8 spaces on the 18-hole circle.

Angular Indexing.

Because the dividing head is geared in a 40:1 ratio, one turn of the crank indexes the spindle $360/40 = 9^\circ$. If the angular distance is in degrees only $= \alpha/9$, where α is expressed in degrees.

Example: To be milled $43^\circ 20'$ apart,

$$T = \frac{\alpha}{90} \rightarrow \frac{43^\circ 20'}{90} = \frac{2600'}{540'} = 4 \frac{22}{27}$$

We might index 4 turns plus 22 holes on the 27-hole plate.

Differential indexing

This process is employed for all index numbers which cannot be obtained by indirect indexing in this case clamp the differential bolt into the rear end of the indexing spindle and loosen the locking pin for the index plate. Then attach the change gears as per indexing table on the bracket or the differential bolt and engage them with a minimum of slack. Then carry out the indexing process in exactly the same manner as described for indirect indexing.

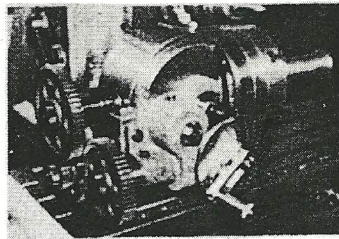

Milling spiral flutes

A twisted flute generally found on twist drills, reamers, screw taps, screw wheels, worms etc. may be always performed by an universal or special dividing attachment if the milling machine used for this purpose is provided with a swivelling table or a swivelling milling spindle head. The spiral is produced by two coincident movements: a straight-lined advancing movement by the milling table and a revolving movement of the workpiece caused by the table leadscrew through change gears gear spindle; worm spindle to the dividing head spindle. These motions are to bear a determined constant and uniform mutual proportion.

The change gear ratio must be selected in such a manner that the course made by the rotation of the table leadscrew is equal to the lead "S" required on the workpiece. Moreover, the milling table is to be swivelled from its zero position to the inclined position corresponding to the spiral lead. The result is a constant perpendicular position of the cutter axis to the lead of the spiral produced.

As long as the milling table still rests in the zero position the cutter should be dressed exactly over the longitudinal axis of the workpiece. Then, the milling table is to be swivelled until the longitudinal axis of the table and the cutter axis are forming the lead angle " " that will then agree with the spiral desired.

The direction of rotation of the desired spiral (lefthand or righthand spiral) determinates the swivelling direction of the milling table which is to be swivelled in such a way that the workpiece during its rotating and forward movement is always moving towards the cutter.

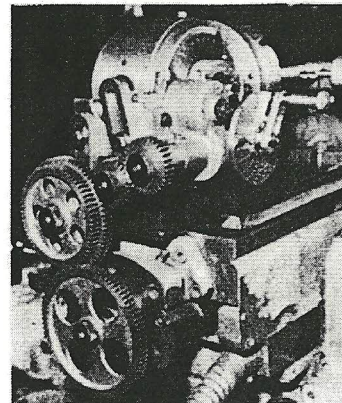

NOTICE :

Take worm in mesh; loose indirect dividing plate; engage indirect dividing index; disengage direct indexing pin.

Rule of division: The change gear ratio "i" required for the desired flute and the setting angle " β " of the milling table are obtained as follows:

$$i = \frac{s \times k}{S} \frac{\text{(driving wheels)}}{\text{(driving wheels)}} \quad \text{tang } \beta = \frac{d \times \pi}{S}$$

s = lead of spindle for table
 k = transmission ratio in the indexing attachment, mostly 40:1
 S = lead of the desired spiral
 i = transmission ratio of change gears
 d = diameter of workpiece
 β = setting angle of milling table

Angle β is found in the Table of Tangens at the corresponding value of tang

Example: How to mill a twist flute

Given: k = 40:1
 S = 12"
 d = 4"
 s = 1/4"

Wanted: a) Setting angle of milling table
 b) Change gears required

$$\text{Solution: a) } \text{tang } \beta = \frac{d \times \pi}{S} = \frac{4 \times \pi}{12} = 1.048$$

according to Table of Tangers: angle $\beta = 6^\circ$

$$\text{b) } i = \frac{s \times k}{S} = \frac{1 \times 40}{4 \times 12} = \frac{40 \text{ (driven wheels)}}{48 \text{ (driving wheels)}}$$

Spiral surfaces (Archimedean spirals) on principle are milled in the same way as spiral flutes, the spindle of dividing head being driven by table leadscrew by means of change-wheels and gearing spindle. Cutter spindle and dividing head spindle must be set perpendicularly to each other or in a suitable angle respectively.

CONSTRUCTIONAL DRAWING

BS-2 DIVIDING HEAD

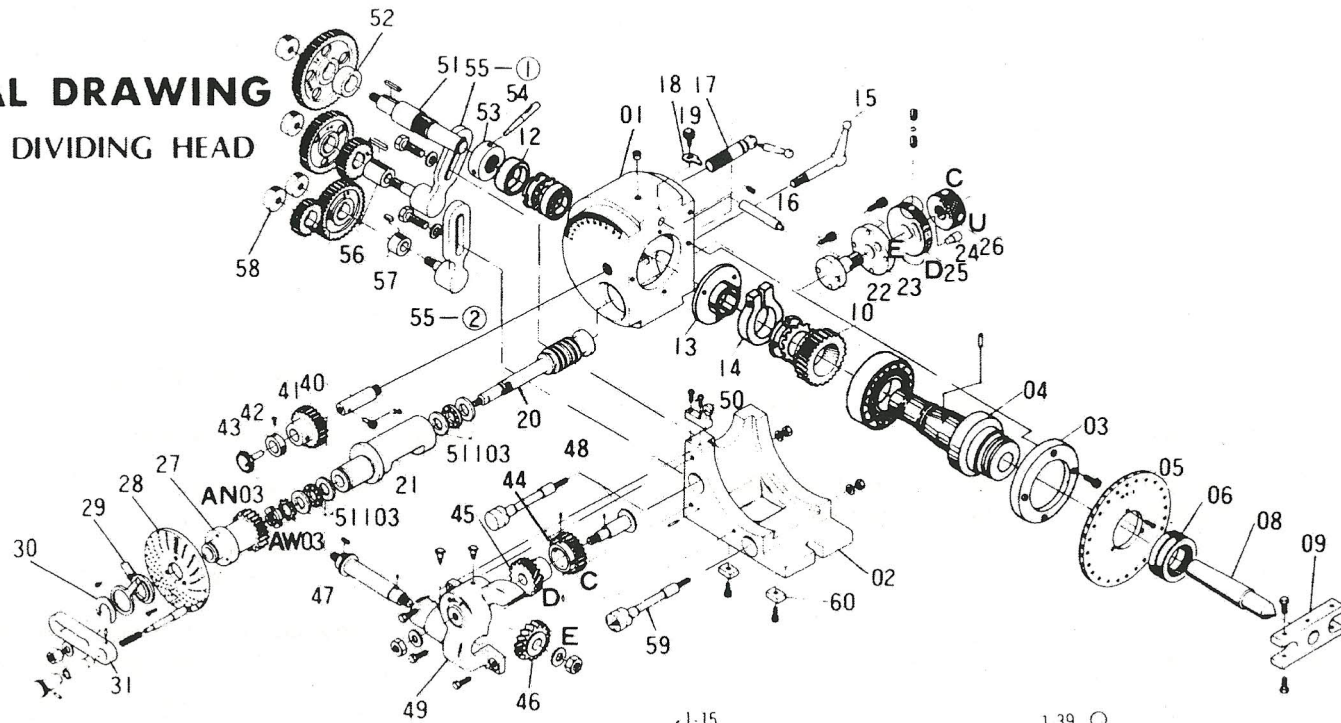

BS-0.1. DIVIDING HEAD

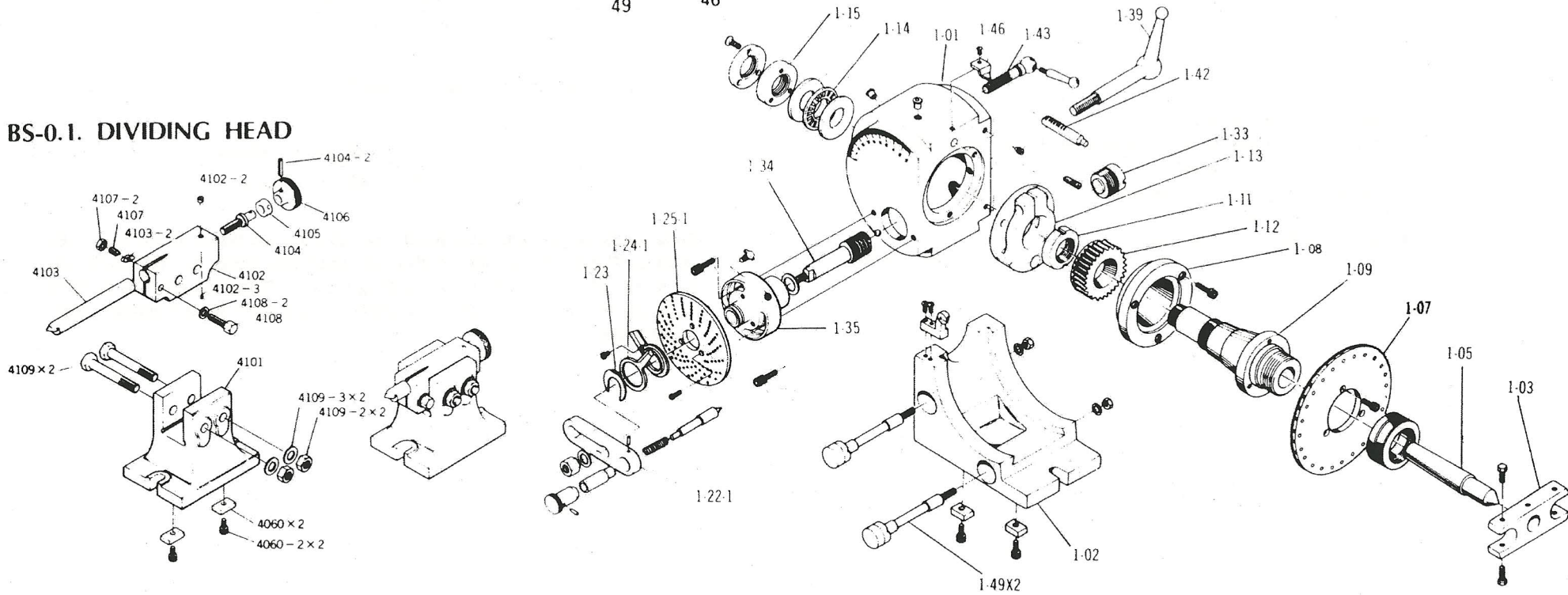

APPLICATION OF CHANGE GEARS

REMARKS:

- A: gear to be hanged on spindle arbor
- B: moving wheel (I)
- C: moving wheel(II)
- D: gear rotation of gear case arbor
- E: gear (I) to be hanged on bracket
- F: gear(II) to be hanged on bracket
- G: gear case arbor
- H: holes of dividing plate
- N: rotation of crank handle
- R:Rs: bracket
- S: spindle arbor

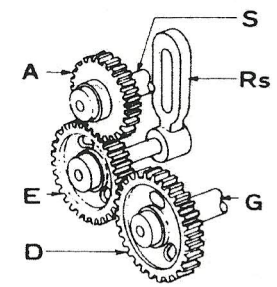

FIG(A)

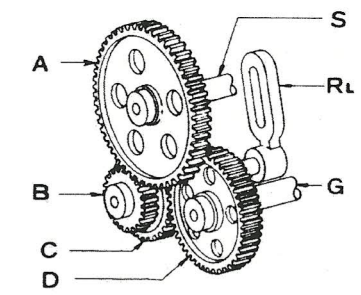

FIG(C)

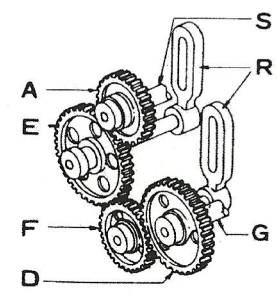

FIG(B)

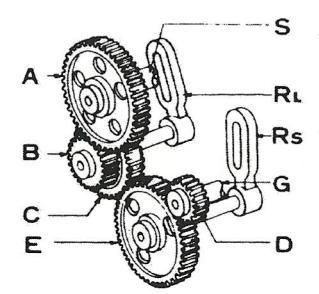

FIG(D)

