

PARTS LIST

FOR

BA900 SERIES

K. O. LEE GRINDERS



— INDEX —

BA900 SERIES GENERAL ASSEMBLY DRAWING	2
BA900 SERIES GENERAL ASSEMBLY PARTS LIST	3
BA900 SERIES STANDARD EQUIPMENT	4
B923 MOTOR ASSEMBLY	5
BA929, BA929-1 TABLE TRANSMISSION ASSEMBLY	4
B955 UNIVERSAL GRINDING HEAD	6, 7
B955HD HEAVY DUTY UNIVERSAL GRINDING HEAD ..	8
B6055B, S6055CL QUILL ASSEMBLIES	9
B935, B935-15 COOLANT ATTACHMENTS	10, 11



See MPL-100 Price List for Prices

K. O. LEE

K. O. LEE COMPANY

ABERDEEN, SOUTH DAKOTA 57401

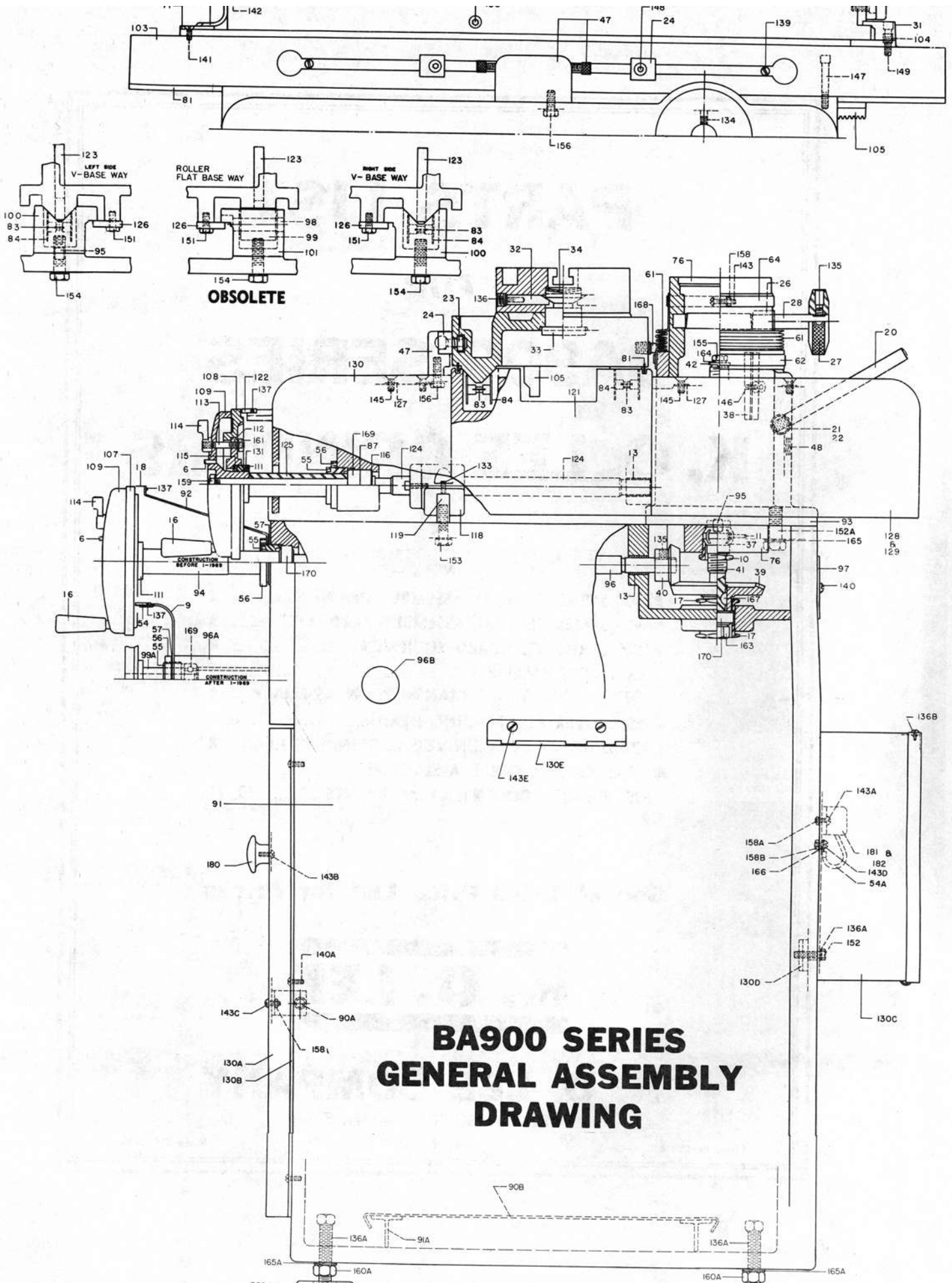

**BA900 SERIES
GENERAL ASSEMBLY
DRAWING**

Index No.	Part No.	Description	Index No.	Part No.	Description
4	A290A	Table Adjusting Screw	114	BA912T	Thumb Nut
6	A636P	Knurled Pin	115	BA912W	Wavy Spring
9	B330BP	Pointer Bracket	116	BA917W	Bearing Shield
10	B624S	Compression Nut	118	BA924	Feed Nut Assembly
11	B625P	Knurled Plug	119	BA924NB	Feed Bar
13	B629M	Bushing		BA929-1	Transmission (page 4)
16	B712H	Handle	121	BA930V	Saddle
17	B805M	Adjusting Nut	122	BA930P	Indicator Plate
18	B805P	Indicator Plate	123	BA930R	Oil Reservoir
19	B805R	Base Stud (out)	124	BA930SF	Feed Screw
20	B805SH	Handle	125	BA930SS	Spacer
21	B805SS	Screw	126	BA930T	Saddle Hold Down Plate
22	B805W	Adjusting Washer	127	BA930W	Vellum Washer
23	B810P	T-Slot Plate	128	BA930WL	Left Rear Saddle Way Shroud (out)
24	B810W	Adjustable Stop	129	BA930WR	Right Rear Saddle Way Shroud (out)
26	B813B	Bushing	130	BA930WC	Front Saddle Way Shroud (V and Flat)
27	B813H	Knurled Hand Nut	130	B6030WC	Front Saddle Way Shroud (Double V)
28	B813S	Eccentric Shaft	130A	BA965DH	Door and Hinge Assembly
29	B815A	Adjusting Screw Pad	130B	BA966HS	Hinge Strip (obsolete)
30	B815B	Pointer	130C	BA967KB	Cutout Box
31	B815C	Clamp Bar	130D	BA967KC	Clamp
32	B815P	Swivel Lock Pin	130E	S890B	Wrench Rack
33	B815S	Swivel	131	10-32 x $\frac{3}{16}$	Socket Set Screw
34	B815X	Plug	133	10-32 x $\frac{1}{2}$	Hex Socket Set Screw
37	B824N	Feed Nut	134	$\frac{1}{4}$ x $\frac{1}{4}$ SAE	Hex Socket Set Screw
38	B825K	Key	135	$\frac{3}{16}$ x $\frac{5}{16}$ USS	Hex Socket Set Screw Cup Pt.
39	S626G	Gear	136	$\frac{1}{16}$ x $\frac{3}{8}$ USS	Hex Socket Set Screw
40	S626P	Pinion	136A	$\frac{1}{2}$ x 2 $\frac{1}{2}$ NC	Square Head Set Screw, Cup Pt.
41	B826S	Elevating Screw	136B	No. 6 x $\frac{3}{8}$	S. T. Pan Head Screw, Type A
42	B826W	Stop Washer	137	No. 2 x $\frac{3}{8}$	S. T. Round Head Screw
47	B830B	Stop Block		6-32 x $\frac{3}{16}$	S. T. Flat Head Screw
48	B830Y	Felt Strip	139	10-32 x $\frac{3}{16}$	S. T. Round Head Screw
54	BA805P	Indicator Plate	140	10-32 x $\frac{3}{8}$	S. T. Round Head Screw
54A	B865BG	Ground Wire (Green)	140A	10-32 x $\frac{1}{2}$	S. T. Round Head Screw
55	BA805N	Lock Nut	141	10-32 x $\frac{3}{8}$	Flat Head Machine Screw (H.B.)
56	BA805R	Lock Ring	142	$\frac{1}{4}$ x $\frac{3}{8}$ SAE	Flat Head Machine Screw (H.B.)
57	BA805Y	Washer	143	10-32 x $\frac{3}{4}$	Round Head Machine Screw
61	B905BA	Accordion Sleeve	143A	8-32 x $\frac{3}{8}$	Round Head Machine Screw
62	B905BL	Long Clamp Band	143B	8-32 x $\frac{1}{2}$	Round Head Machine Screw
64	B905BS	Short Clamp Band	143C	10-32 x $\frac{5}{16}$	Round Head Machine Screw (HB)
71	B910T	Index Plate	143D	10-32 x $\frac{3}{8}$	Round Head Machine Screw (Brass)
72	B915	Top Table	143E	10-32 x $\frac{1}{4}$	Round Head Machine Screw
76	B925	Column	144	$\frac{1}{4}$ x $\frac{5}{8}$ SAE	Fill Head Cap Screw
81	B930HE	Saddle Way Dust Shield	145	$\frac{1}{4}$ x $\frac{3}{8}$ SAE	Flat Head Socket Cap Screw
83	B930RP	Oil Roller Plate	146	$\frac{1}{4}$ x $\frac{5}{8}$ SAE	Socket Head Cap Screw
84	B1030RR	Oil Roller	147	$\frac{1}{4}$ x $1\frac{1}{2}$ SAE	Hex Socket Cap Screw
87	B930SW	Preload Washer	148	$\frac{3}{16}$ x $\frac{3}{4}$ SAE	Hex Socket Cap Screw
90	B960R	Rubber Pad (out)	149	$\frac{5}{16}$ x 1 SAE	Hex Socket Cap Screw
90A	B965DC	Door Catch (old style)		$\frac{3}{16}$ x 3 $\frac{1}{2}$ USS	Hex Socket Cap Screw
	B965DD	Door Catch (new style)	151	$\frac{1}{4}$ x $\frac{1}{2}$ SAE	Hex Cap Screw
90B	BA905BB	Plate for Tank		$\frac{5}{16}$ x $\frac{7}{8}$ SAE	Hex Cap Screw
91	BA905BC	Base	152	$\frac{1}{4}$ x 1 NF	Hex Cap Screw
91A	BA905BT	Base	152A	$\frac{1}{2}$ x 2 NC	Hex Cap Screw
	or BA905BUS	Rail for Tank	153	$\frac{3}{8}$ x $1\frac{1}{4}$ SAE	Hex Cap Screw
92	BA905BP	Pointer Bracket	154	$\frac{7}{16}$ x $1\frac{1}{4}$ SAE	Hex Cap Screw
93	BA905C	Column Housing	155	$\frac{5}{16}$ x $\frac{1}{2}$ USS	Hex Cap Screw
94	BA905D	Spacer	156	$\frac{3}{16}$ x 1 USS	Hex Cap Screw
95	BA905DP	Dowel Pin	158	10-32	Hex Nut (H.B.)
96	BA905E	Handwheel Shaft	158A	8-32	Hex Nut (HB)
96A	BA905H	Housing	158B	10-32	Hex Nut (Brass)
96B	BA905HP	Hole Plug	159	$\frac{7}{16}$ SAE	Hex Jam Nut (H.B.)
96C	BA905GR	Leveling Pad	160	$\frac{1}{2}$ SAE	Hex Nut
97	BA905P	Back Plate	160A	$\frac{1}{2}$ NC	Hex Jam Nut
98	BA905RA	Roller Axle (out)	161	$\frac{1}{4}$ USS	Hex Jam Nut (H.B.)
99	BA905RR	Roller (out)		$\frac{3}{8}$ USS	Hex Nut (H)
99A	BA905S	Spacer	163	$\frac{1}{2}$ USS	Hex Nut
100	B2005WV	Base Way — Vee	163A	$\frac{1}{4}$ Std.	Lock Washer
101	B2005WVR	Base Way — Vee	164	$\frac{5}{16}$ Std.	Lock Washer
102	BA905S	Base Stud	165	$\frac{1}{2}$ Std.	Lock Washer
103	BA910	Sub Table	165A	$\frac{1}{2}$	Shakeproof Washer
104	BA910B	Aligning Sleeve		$\frac{3}{8}$ SAE	Washer (H)
105	BA910R	Rack	166	$\frac{3}{16}$ Std.	Lock Washer
	BA912C	Handwheel Assembly (100 divisions)	167	No. 2	Woodruff Key $\frac{3}{32}$ x $\frac{1}{2}$
107	BA912D40	Index Disc (40 divisions)	168	$\frac{1}{4}$	Pipe Plug
108	BA912D100	Index Disc (100 divisions)	169	201KTD	Ball Bearing
109	BA912H	Handwheel	170	202KLL3	Ball Bearing
	BA912K	Handwheel Assembly (40 divisions)	180	3006B	Knob (obsolete)
111	BA912L	Lock Ring	181	CR151C10	End Block
112	BA912P	Lock Plate	182	CR151C2200	Box Terminal Block
113	BA912S	Stud			

BA929 AND BA929-1 TABLE TRANSMISSION ASSEMBLY

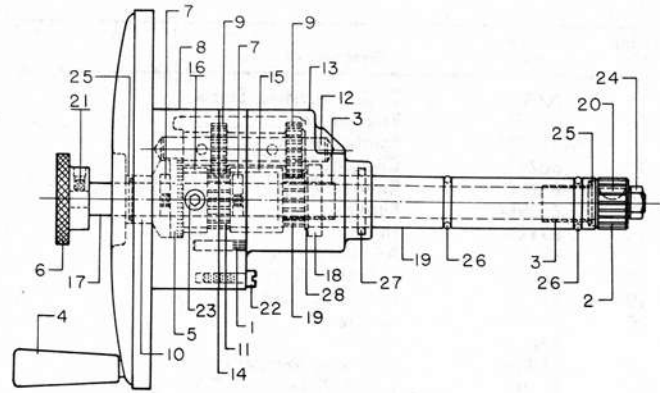

Index No.	Part No.	Description
1	A629J	Knurled Pin
2	B610KG	Pinion Gear
3	AA-710-16	Oilite Bearing
4	B712H	Handle
4	*B829B	Handle
5	B829CJ	Clutch Jaw
6	B829K	Control Knob
7	B829T	Drive Pin
8	B929C	Cover (obsolete)
8	*BA929C	Cover
	*BA929CS	Bearing Shield
	*BA929A	Adjustable Crank Arm
9	B929CA	Cluster Gear
10	B929CB	Cover Bushing
11	B929CC	Cover Gasket
12	B929CS	Cluster Gear Shaft
13	B929H	Housing
14	B929L	Drive Gear
15	B929LL	Drive Gear Spacer — Long

Index No.	Part No.	Description
16	B929LS	Drive Gear Spacer — Short
17	BA929S	Drive Shaft (BA929)
17	B6029S	Drive Shaft (BA929-1)
18	B929W	Thrust Collar
19	BA929Y	Stationary Shaft (BA929)
19	B6029Y	Stationary Shaft (BA929-1)
20	No. 2	Woodruff Key
21	10-32 x 3/16	Hex Socket Set Screw
22	10-32 x 5/8	Fill. Head Machine Screw
23	1/8 Briggs	Socket Pipe Plug
24	3/8 SAE	Hex Nut
25	B56-40-2	Oil Seal — Trostel Packing 5/8 x 7/8 x 1/8
26	8210	O-Ring (1/8 x 3/4 x 1)
27	8215	O-Ring (1/8 x 1 1/16 x 1 3/16)
28	RS-100	Spirolox
	S7KD	Ball Bearing
	*S629L	Lock Screw
	*3/8 SAE	Hex Jam Nut (H.B.)
	*3/8 Std.	Lock Washer

*Used on BA929 Table Transmission Assembly with Adjustable Crank Arm

BA900 SERIES STANDARD EQUIPMENT

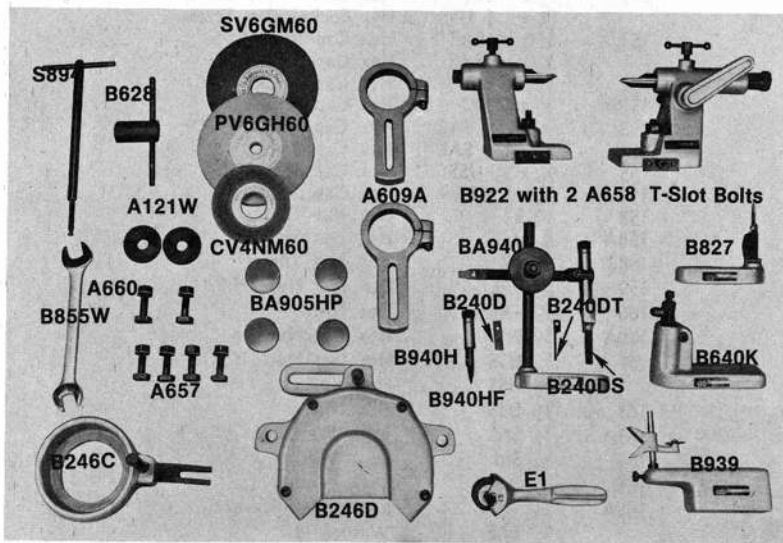

STANDARD EQUIPMENT FOR MODEL BA960

A657 T-Slot Bolt, A660 T-Slot Bolt, B640K Diamond Dresser, B827 Plain Tooth Rest, B922 Tail Stock (Matched Set), B939 Center Gauge, BA940 Universal Tooth Rest, B955 Universal Grinding Head, E1 Wheel Dresser.

STANDARD EQUIPMENT FOR MODEL BA900

A609A T-Slot Arm, A657 T-Slot Bolt (4), A660 T-Slot Bolt (2), B246C Wheel Guard 4", B246D Wheel Guard 6", B628 Wrench, B640K Diamond Dresser, B827 Plain Tooth Rest, B855W Wrench, B856B Bracket, B922 Tailstocks (Matched Set) with two A258 T-Slot Bolts, B923G Motor Assembly, B939 Center Gauge, BA940 Universal Tooth Rest (B940H Micrometer Tooth Rest. Blades: B240D, B240DS, B240DT, B940HF), E1 Wheel Dresser, CV4NM60 Cup Wheel, PV6GH60 Straight Wheel, SV6GM60 Saucer Wheel.

STANDARD EQUIPMENT FOR MODEL BA900X

A609A T-Slot Arm, A660 T-Slot Bolt, B246C 4" Wheel Guard, B246D 6" Wheel Guard, B628 Wrench (7/8" socket), S894 Wrench, B855W Wrench (1/8" & 3/4"), B923G Motor Assembly.

B923 MOTOR ASSEMBLY

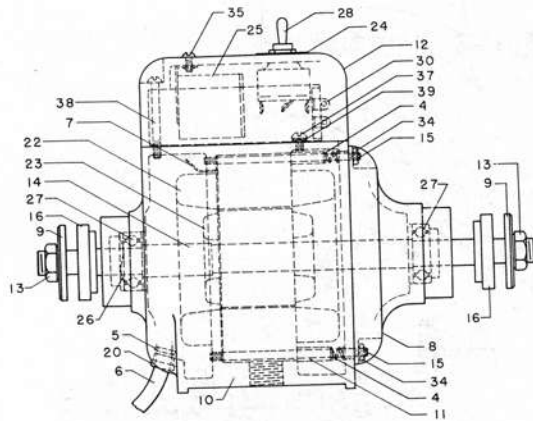

B923 Motor Assembly shown complete with Reversing Switch.

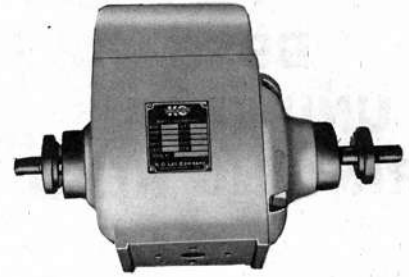

Index No.	Part No.	Description
4	A260HS	Spring
5	A612	Cord Retainer
6	A638D	Power Wire (16-3 Type SJ)
6	A638E	Power Wire (No. 16-4 Type SO)
7	B923EC	Wire Clamp
8	B923EE	End Bell
9	B923EF	Keyed Wheel Flange
10	B923EH	Motor Housing
11	B923EK	Spacer (B923A Motor)
11	B923EJ	Spacer (B923G Motor)
11	B923EM	Spacer (B923K Motor)
12	B923EL	Switch Bracket
13	B923EN	Specil Nut
	B923EP	Knurled Plug
14	B923ES	Shaft
15	B923ET	Stud
	B923ETL	Stud
16	B923EW	Wheel Flange
	B923KN	Data Plate
	B923LS	Lamp Stud
	3/4 x 1/8 SAE	Hex Cap Screw
	0618-P	Light Fixture
	B990W	Jumper Wire
	B990X	Jumper Wire
	B990Y	Jumper Wire

Index No.	Part No.	Description
20	K5G	Grommet
21	K5L	Collar
22	K306G101	Field (B923K Motor)
22	KC30LG101	Field (B923A Motor)
22	K30JG100	Field (B923G Motor)
23	K306G101	Rotor (B923K Motor)
23	KC30LG101	Rotor (B923A Motor)
23	K30JG100	Rotor (B923G Motor)
24	KO-20	Plate
25	3ARR3C2N3	Relay
26	8Z	Adjusting Spring
27	203KDD	Ball Bearing
28	7612K2	Switch
30	235637	Capacitor
34	8-32	Hex Nut
35	8-32 x 3/8	Round Head Machine Screw (NP)
37	10-32 x 3/16	Round Head Brass Screw
38	10-32 x 2	Round Head Machine Screw
39	3/16	Lock Washer
	8-32 x 1/4	Round Head Brass Machine Screw
	34070	Connector
	No. 2 x 1/8	S. T. Round Head Screw
	31891	Terminal
	31881	Terminal
	767	Bryant Wire Connector (3-18 Wire)

AVAILABLE MOTOR MOUNT ADAPTERS

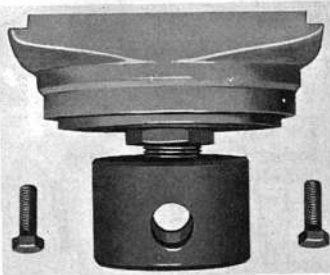

B908 Motor Saddle Assembly will adapt B923 Motors to B900, BA900, B900X, BA900X, B800 and BA800.

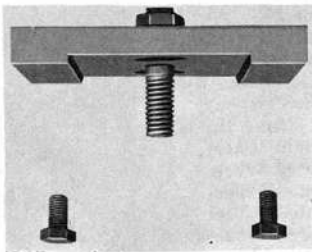

B923S Adapter Slide adapts the B923 Motor Assembly to the B860 Grinder and B855 Speed Head.

MOTOR ASSEMBLIES

FOR ALL K. O. LEE GRINDERS
Complete with reversing switch.

- B923A** 1/2 HP, 115/230V, 1 Phase, 60 Cy.
- B923B** 1/2 HP, 208V, 3 Phase, 60 Cycle.
- B923C** 1/2 HP, 230/440V, 3 Ph., 60 Cycle.
- B923J** 1/2 HP, 220/380V, 3 Ph., 50 Cycle.
- B923W** 1/2 HP, 550V, 3 Phase, 60 Cycle.
- B2023A** 1 HP, 115/230V, 1 Ph., 60 Cycle.
- B2023B** 1 HP, 208V, 3 Phase, 60 Cycle.
- B2023G** 1 HP, 220/440V, 3 Ph., 60 Cycle.
- B3023G** 2 HP, 220/440V, 3 Ph., 60 Cycle.
- B4023G** 3 HP, 220/440V, 3 Ph., 60 Cycle.

Specify Motor Part No. and Correct Adapter Plate Part No. for Your Model Grinder.

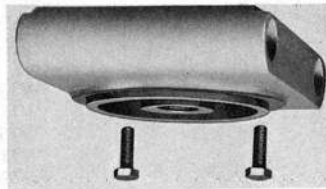

B945B Bracket adapts the B845, B945 Tilting Table to the B900, B900X, BA900, and BA900X Grinders.

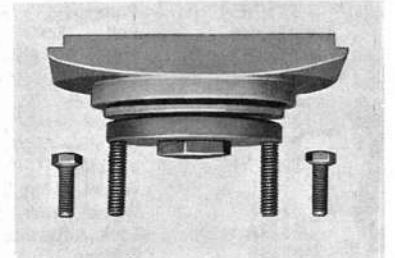

B925A Motor Saddle Assembly adapts the B923 Motor to the A290, A600, B600, B603 and B604 Grinders.

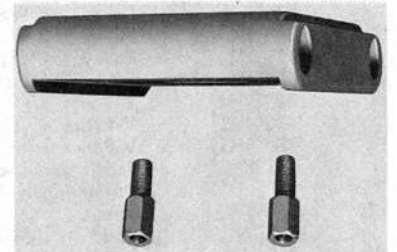

B945C Bracket adapts B845, B945 Tilting Table to the B955 Speed Head and B960 and BA960 Grinders.

B955 UNIVERSAL GRINDING HEAD

PARTS WITHOUT INDEX
NUMBERS ARE SHOWN
IN STANDARD EQUIPMENT
PHOTO ON PAGE 7

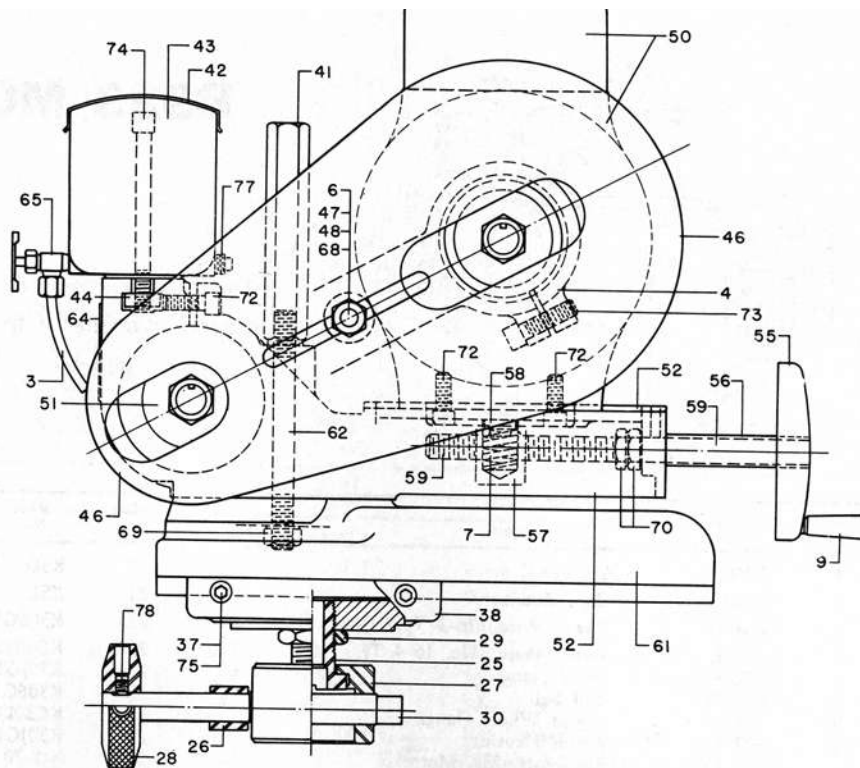

Index No.	Part No.	Description
	A32	Mounted Cup Wheel
	A36	Mounted Wheel
	A37	Mounted Wheel
3	A267LT	Tube (3/8" x 6") (out)
4	A609A	T-Slot Arm
	A657	T-Slot Bolt
6	A663B	T-Slot Bolt
	B246C	Wheel Guard 4"
	B246D	Wheel Guard 6"
7	B610PS	Compression Spring (2 Required)
	B628	Wrench
9	B685YH	Handle
	B780C	Collet Assembly
	B780HB	Spacer
	B780H2	Pulley 2 1/2" (For Flat Belts)
	B780H3	Pulley 2" (For Flat Belts)
	B780H4	Pulley 1 1/2" (For Flat Belts)
	B780H5	Pulley 1 1/4" (For Flat Belts)
	B780H6	Pulley 1 1/8" (For Flat Belts)
	B780H7	Pulley 1" (For Flat Belts)
	B2055H5	V-Pulley 2 3/8"
	B2055H6	V-Pulley 2"
	B2055H7	V-Pulley 1 1/2"
	B2055H8	V-Pulley 1 1/4"
	B2055H9	V-Pulley 1 1/8"
	B780J	Wheel Arbor 5-40
	B780K	Wheel Arbor 1/4"-28
25	B813A	Lock Adjusting Screw
26	B813B	Bushing
27	B813C	Cage
28	B813H	Knurled Hand Nut
29	B813N	Lock Nut
30	B813S	Eccentric Shaft
	S894	Hex Wrench
	B855F	Pulley and Wheel Arbor Assembly
	B855H1	Pulley 3 3/8" (2 Req.) (For Flat Belts)
	B855H2	Pulley 4 1/2" (For Flat Belts)
	B855H3	Pulley 6" (For Flat Belts)
	B2055H1	V-Pulley 3 3/8"
	B2055H2	V-Pulley 4 1/2"
	B2055H3	V-Pulley 6"
	B855K	Saddle and Lock Assembly
37	B855L	Dovetail Plug (2 Required)
38	B855S	Saddle
	B855W	Wrench 1 1/16" and 3/4"
41	B855Y	Special Nut
42	B856C	Cover (out)
43	B856G	Tank (out)
44	B856P	T-Slot Plate (out)

Index No.	Part No.	Description
46	B860G	Belt Guard (replaced by B960G)
47	B860GN	Special Nut (no longer standard)
48	B860GS	Spacer (no longer standard)
50	B923A	1/2 HP Motor Assembly, 115/230V, 1 Ph.
50	B923G	1/2 HP Motor Assembly, 220/440V, 3 Ph.
50	B923K	3/4 HP Motor Assembly, 220/440V, 3 Ph.
51	B6055B	Quill Assembly
52	B955B	Quill Bracket
	B955DA	Arm for Wheel Guard
	B955DB	Bracket for Wheel Guard
55	B955HB	Handwheel
56	B955HC	Collar
57	B955HN	Feed Nut
58	B955HP	Spring Plug (2 Required)
59	B955HS	Belt Tightener Screw
	B955N	Name Plate
61	B955P	Dovetail Slide
62	B955X	Swivel Stud
64	KO-16	Speed Chart
65	6845	Shut Off Cock (out)
68	3/8 USS Hex	Nut (H) (2 Required)
69	3/16 SAE Hex	Nut
70	1/2 NF	Hex Jam Nut
72	5/16 x 3/4 SAE	Hex Socket Cap Screw
73	5/16 x 1 1/4 SAE	Hex Socket Cap Screw
74	5/16 x 3 1/2 USS	Hex Socket Cap Screw
75	B955G	Lock Screw Assembly
77	1/8	Pipe Plug (out)
78	5/16 x 3/16 USS	Hex Socket Set Screw
	1 1/4 x 22	Flat Belt
	1 1/4 x 24	Flat Belt
	1 1/4 x 26	Flat Belt
	1 1/4 x 28	Flat Belt
	5M560	V-Belt 22"
	5M615	V-Belt 24"
	5M670	V-Belt 26"
	5M710	V-Belt 28"
	1/2 SAE	Hex Jam Nut
	3/8 SAE	Washer (H)
	No. 2 x 1/8	S. T. Round Head Screw
	W160	Mounted Wheel
	W162	Mounted Wheel
	W163	Mounted Wheel
	W184	Mounted Wheel
	W194	Mounted Wheel
	CV4NM60	Cup Wheel
	PR6AH70	Cut Off Wheel
	PV5FH60	Straight Wheel
	SV6GM60	Saucer Wheel

B955 UNIVERSAL GRINDING HEAD (with Flat Belts & Pulleys)



**OBSELETE —
FOR PARTS
SELECTION
ONLY**

STANDARD EQUIPMENT FOR B955 UNIVERSAL GRINDING HEAD

A246C Wh. Guard 4", A246D Wh. Guard 6", A609A T-Slot Arm, A657 T-Slot Bolt, A663 T-Slot Bolt, B628 Wrench, B780C Collet Chuck Assembly, B780HB Spacer Bushing, B780H3 Pulley 2", B780H4 Pulley 1½", B780H5 Pulley 1¼", B780H6 Pulley 1⅜", B780H7 Pulley 1", B780J Wheel Arbor (5-40), B780K Wheel Arbor, S894 Hex Wrench, B855F Pulley and Wheel Arbor Assembly, B855H1 Pulley 3⅜", B855H2 Pulley 4½", B855H3 Pulley 6", B855W Wrench, B855Y Special Nut, B856 Tank Assembly, B860C Belt Guard, B860GN Special Nut, B860GS Spacer, B923 () Motor Assembly, B955DA Arm for Wheel Guard, B955DB Bracket for Wheel Guard, 1¼" x 24" Flat Belt, 1¼" x 26" Flat Belt, 1¼" x 28" Flat Belt, A32 Mounted Cup Wheel, A36 Mounted Wheel, A37 Mounted Wheel, W160 Mounted Wheel, W162 Mounted Wheel, W163 Mounted Wheel, W184 Mounted Wheel, W194 Mounted Wheel, CV4NM60 Cup Wheel, PR6AH70 Cut Off Wheel, PV5FH60 Straight Wheel, SV6GM60 Saucer Wheel

GRINDING HEAD SPEEDS		
Motor Pulley Diameter	Quill Pulley Diameter	Spindle Speed R.P.M.
3⅜	3⅜	3450
4½	3⅜	4600
3⅜	2	5820
4½	2	7760
6	2	10350
6	1½	13800
6	1¼	16560
6	1⅜	18400
6	1	20700

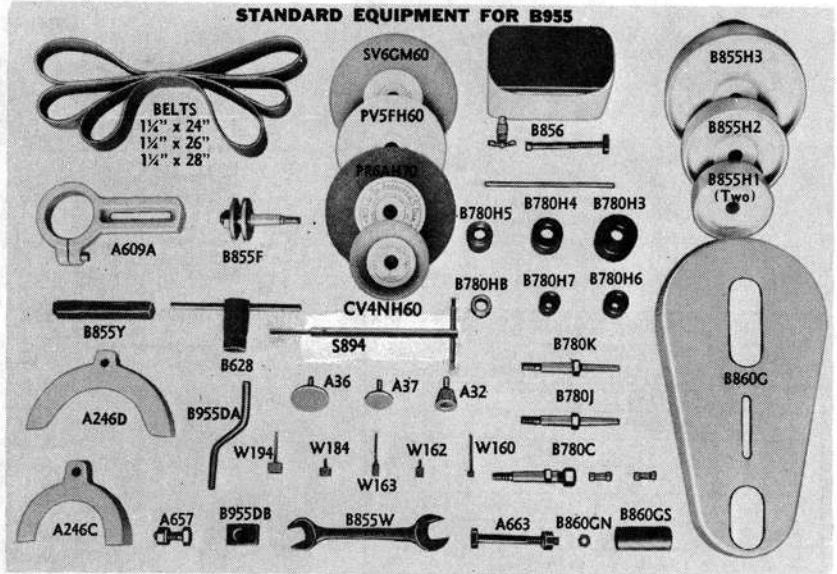

GUARDS OBSELETE — ORDER B955BT BRACKET AND GUARDS FROM PICTURE BELOW

B955 UNIVERSAL GRINDING HEAD (with V-Belts & Pulleys)



STANDARD EQUIPMENT FOR B955 UNIVERSAL GRINDING HEAD

A609A T-Slot Arm, A657 T-Slot Bolt, A659 T-Slot Bolt, B246C Wheel Guard 4", B246D Wheel Guard 6", B628 Wrench, B780C Collet Chuck Assembly, includes B780CD ¼" & B780CE ¼" Collets, B780J Wheel Arbor (5-40), B780K Wheel Arbor (¼-28), B855F Pulley and Wheel Arbor Assembly, B855W Wrench, B960C Belt Guard, B923C Motor, B955BT Bracket for Wheel Guard or Tooth Rest, B955PC Dovetail Clamp Assembly, B6055B Quill Assembly, B2055H1 V-Pulley 3⅜" (2), B2055H2 V-Pulley 4½", B2055H3 V-Pulley 6", B2055H5 V-Pulley 2⅜", B2055H6 V-Pulley 2", B2055H7 V-Pulley 1½", B2055H8 V-Pulley 1¼", B2055H9 V-Pulley 1⅜", S894 Hex Wrench, A32 Mounted Cup Wheel, A36 Mounted Wheel, A37 Mounted Wheel, W160 Mounted Wheel, W162 Mounted Wheel, W163 Mounted Wheel, W184 Mounted Wheel, W194 Mounted Wheel, CV4NM60 Cup Wheel, PR6AH70 Cut Off Wheel, PV5FH60 Straight Wheel, SV6GM60 Saucer Wheel, 5M560 V-Belt 22", 5M615 V-Belt 24", 5M670 V-Belt 26", 5M710 V-Belt 28".

B6055B SPEED CHART KO-16				
Diameter of Wheel	Wheel Speed R.P.M.	Pulley on Motor	Pulley on Spindle	Belt Used
6 TO 5	3,450	3⅜	3⅜	5M615
5 TO 4	4,600	4½	3⅜	5M670
6 TO 5	3,450	2½	2½	5M560
4 TO 3	5,820	3⅜	2	5M615
3 TO 2	7,760	4½	2	5M710
2 TO 1½	10,350	6	2	5M670
1½ TO 1	13,800	6	1½	5M670
1 TO ¾	16,560	6	1¼	5M670
¾ TO ½	18,400	6	1⅜	5M670

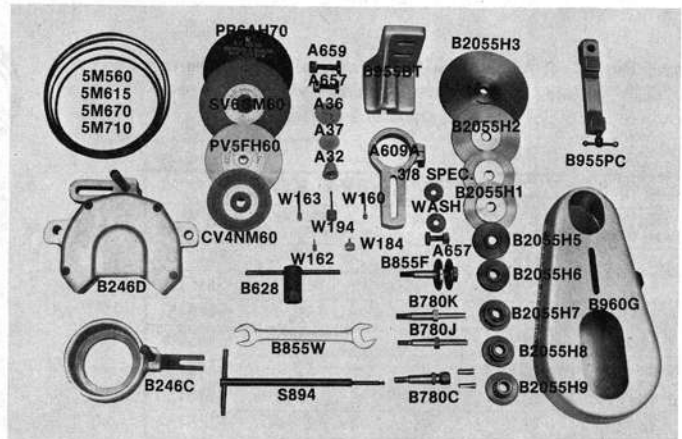

B955HD HEAVY DUTY UNIVERSAL GRINDING HEAD (with Flat Belts and Pulleys)



**OBSOLETE —
FOR PARTS
SELECTION
ONLY**

STANDARD EQUIPMENT FOR B955HD UNIVERSAL GRINDING HEAD

A246C Wheel Guard 4", A246D Wheel Guard 6", A246E Wheel Guard, A267LT Tube, A609A T-Slot Arm, A657 T-Slot Bolt, A663 T-Slot Bolt, B628 Wrench, B780H2 Pulley 2½", B780H3 Pulley 2", S894 Hex Wrench, B855H1 Pulley 3¾" (2), B855H2 Pulley 4½", B855H3 Pulley 6", B855W Wrench, B855Y Special Nut, B856 Tank Assembly, B856P T-Slot Plate, B860G Belt Guard, B860GN Special Nut, B860GS Spacer, B923 () Motor Assembly, B936C Collet (2), B936CB Body, B936CS Wheel Spacer, B936CW Collet Keyed Washer, B936CN Nut, B936P Puller, B936W Wrench, B955DA Arm for Wheel Guard, B955DB Bracket for Wheel Guard, 1¼" x 22" Flat Belt, 1¼" x 24" Flat Belt, 1¼" x 26" Flat Belt, CV4NM60 Cup Wheel, PR8AM70 Cut Off Wheel, PV7GM60 Plain Wheel, SV6GM60 Saucer Wheel.

Diameter Of Wheel	Wheel R.P.M.	Pulley On Motor 3450	Pulley On Spindle
	1150	2	6
	2580	3⅞	4½
7 to 5½	3450	3⅞	3⅞
7 to 5½	3450	2⅞	2⅞
5½ to 4	4600	4½	3⅞
4 to 3	6210	4½	2½
3 to 2½	7760	4½	2

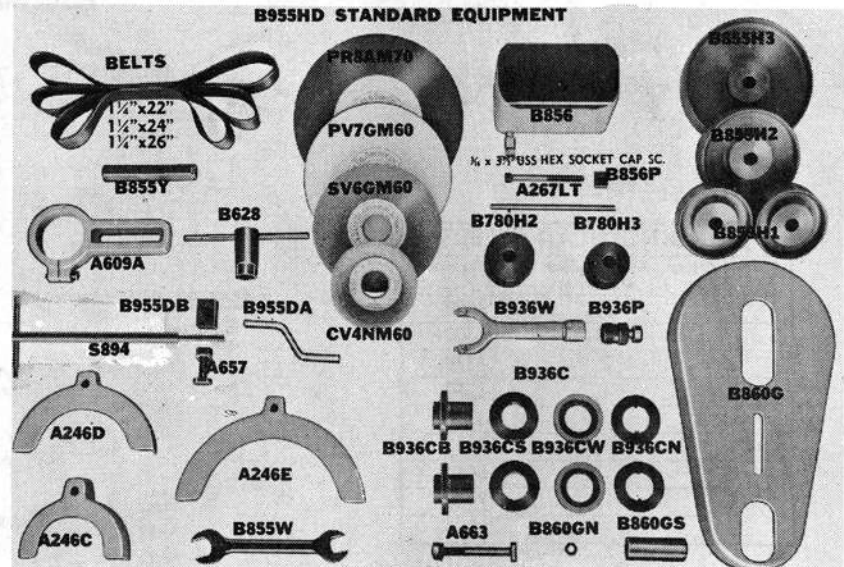

GUARDS OBSOLETE — ORDER B955BT BRACKET AND GUARDS FROM PICTURE BELOW

B955HD HEAVY DUTY UNIVERSAL GRINDING HEAD (with V-Belts and V-Pulleys)

STANDARD EQUIPMENT FOR B955HD UNIVERSAL GRINDING HEAD

A609A T-Slot Arm, A657 T-Slot Bolt, A659 T-Slot Bolt, B246C Wheel Guard 4", B246D Wheel Guard 6", B246E Wheel Guard 8", B628 Wrench, B855W Wrench, B923G Motor, B936C Collet (2), B936CB Body, B936CS Wheel Spacer, B936CW Collet Keyed Washer, B936CN Nut, B936P Puller, B936W Wrench, B955BT Bracket for Wheel Guard or Tooth Rest, B955PC Dovetail Clamp Assembly, B960G Belt Guard, B2055H1 V-Pulley 3¾" (2), B2055H2 V-Pulley 4½", B2055H3 V-Pulley 6", B2055H5 V-Pulley 2¾", B2055H6 V-Pulley 2", CV4NM60 Cup Wheel, PR8AM70 Cut Off Wheel, PV7GM60 Plain Wheel, SV6GM60 Saucer Wheel, S894 Hex Wrench, S6055CL Quill Assembly, 5M560 V-Belt 22", 5M615 V-Belt 24", 5M670 V-Belt 26", 5M710 V-Belt 28".

B955HD HEAVY DUTY UNIVERSAL GRINDING HEAD IS AVAILABLE AT EXTRA COST.

Heavy Duty Quill Assembly with two sets of Duplex Bearings for O.D. Grinding and Surface Grinding is standard equipment on the B955HD Universal Grinding Head.

Diameter Of Wheel	Wheel R.P.M.	Pulley On Motor 3450	Pulley On Spindle	Belt Used
	1150	2	6	5M710
	2580	3⅞	4½	5M670
7 to 5½	3450	3⅞	3⅞	5M615
7 to 5½	3450	2⅞	2⅞	5M560
5½ to 4	4600	4½	3⅞	5M670
4 to 3	6210	4½	2½	5M615
3 to 2½	7760	4½	2	5M615

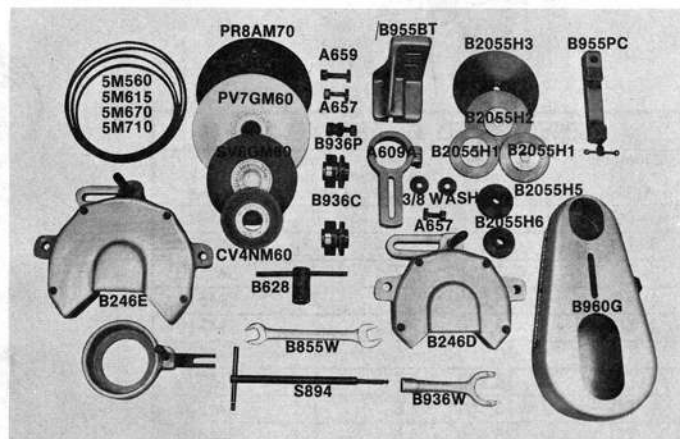

B6055B QUILL ASSEMBLY

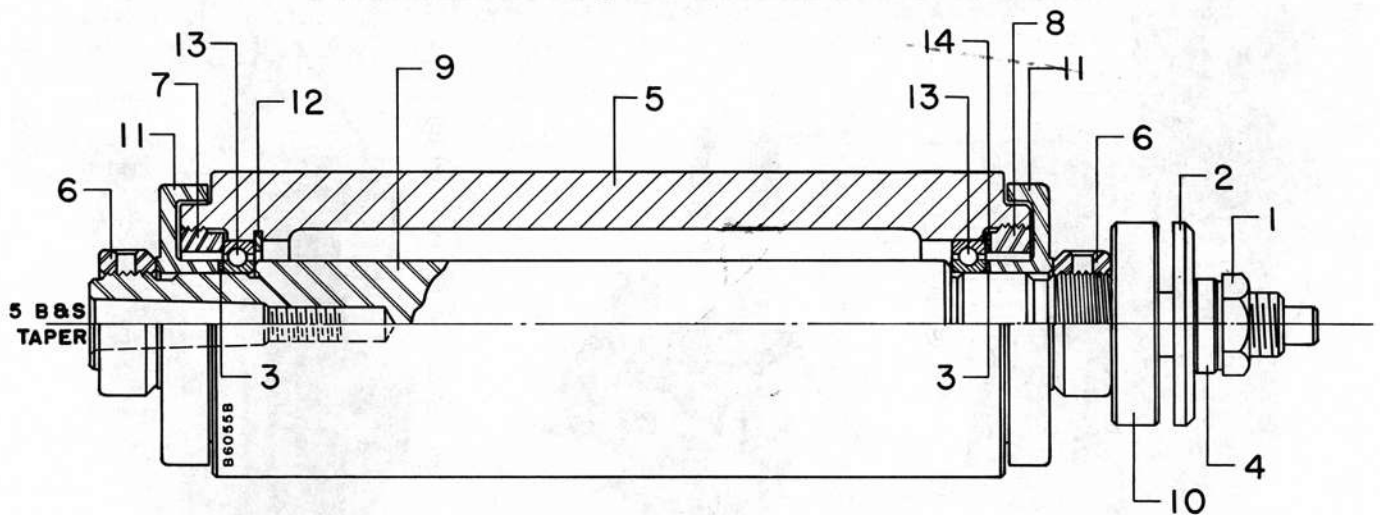

Index No.	Part No.	Description	Quan. Req.	Index No.	Part No.	Description	Quan. Req.
1	B923EN	Nut	1	7	B6055AR1	Retainer Nut for Bearing	1
2	B923EF	Keyed Wheel Flange	1	8	B6055AR2	Retainer Nut for Bearing	1
3	B955AW5	Circular Shim	2	9	B6055BS	Spindle	1
3	B955AW15	Circular Shim	1	10	A624S	Spacer Washer	1
4	B2055H10	Spacer for Pulley	2	11	S755CC	Cap	2
5	B6055AH	Housing	1	12	3000-X165	Ring — Internal No. 1300	1
6	B6055AN	Lock Nut	2	13	2MM9305WOCRUM	Ball Bearing Duplex	1 pr.
				14	9Z	Wavy Spring	2

S6055CL QUILL ASSEMBLY

FOR B955HD HEAVY DUTY UNIVERSAL GRINDING HEAD

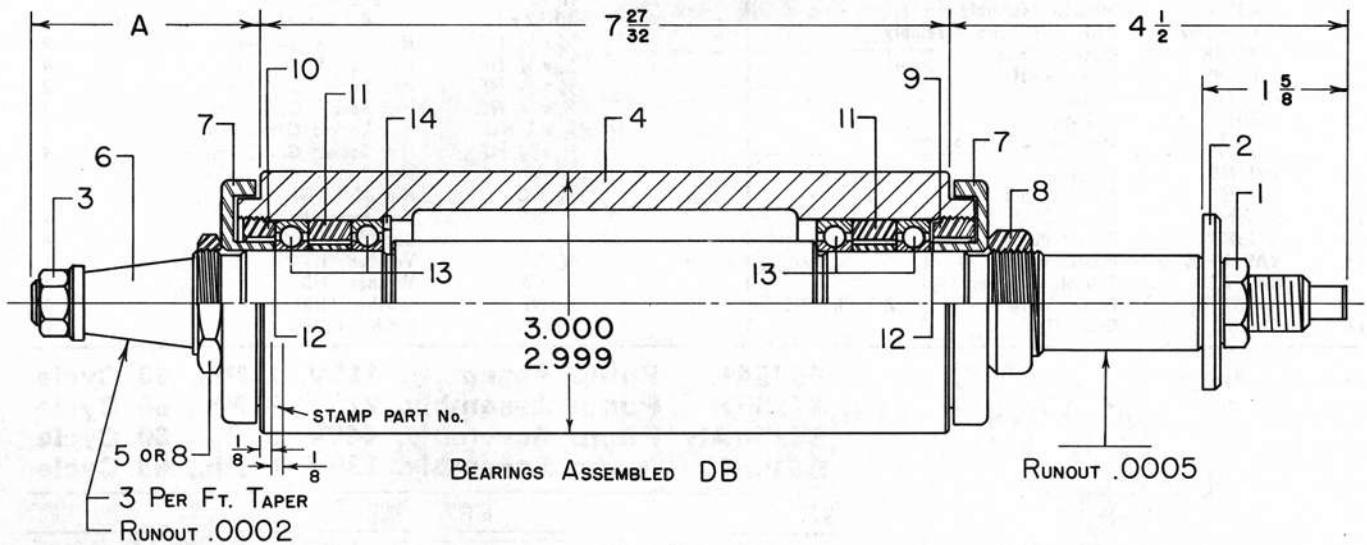

Index No.	Part No.	Description	Quan. Req.	Index No.	Part No.	Description	Quan. Req.
1	B923EN	Nut	1	8	B6062AN	Lock Nut	1
2	B923EF	Washer — Keyed	1	9	B6062AR	Retainer Nut for Bearing $\frac{7}{16}$ "	1
3	B936NL	Nut (Left Hand Thread)	1	10	B6062AR2	Retainer Nut for Bearing $\frac{3}{8}$ "	1
4	B955AH	Housing	1	11	B6062AW	Spacer for Bearing	2
5	S6055CN	Special Nut	1	12	B6062AY5	Circular Shim .005"	2
6	S6055S5	Spindle	1	12	B6062AY15	Circular Shim .015"	1
7	B6062AC	Cap	2	13	2MM9306-WO-CR-DUM	Bearings	2 pr.
				14	3000-X187	Retainer Ring — Int.	1

NOTICE: WE DO NOT RECOMMEND IN FIELD SERVICE ON THESE QUILLS. IF ATTEMPTED, WE ARE NOT RESPONSIBLE FOR SPINDLE OR BEARING DAMAGE.

B935 COOLANT ATTACHMENT

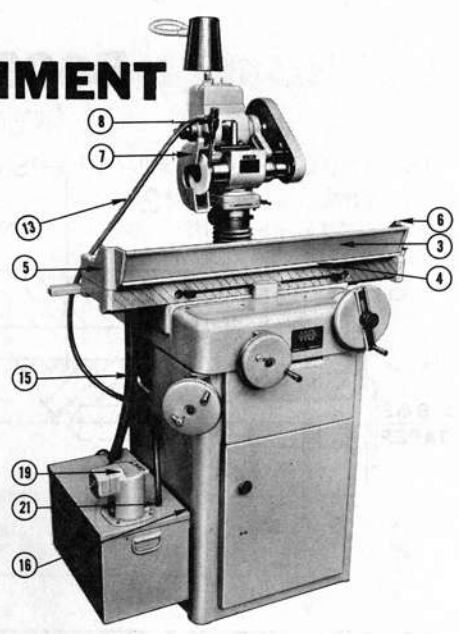
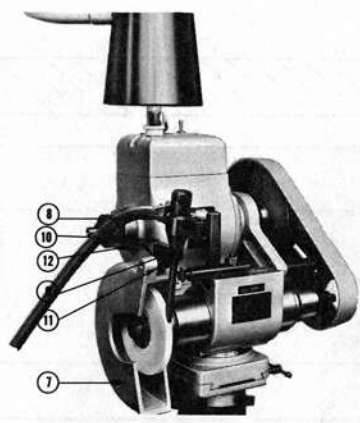
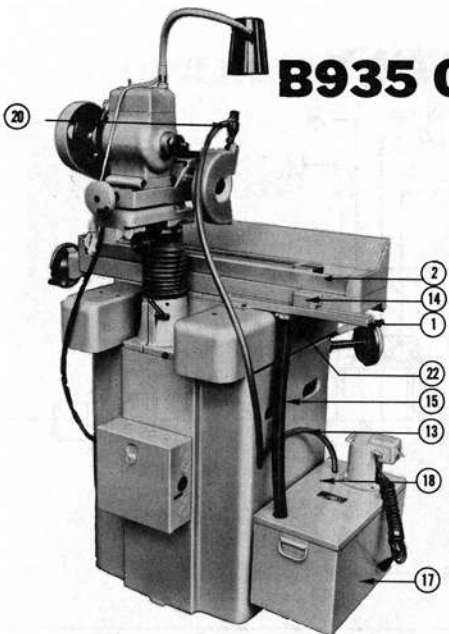

Index No.	Part No.	Description	Quan. Req.
	A657B	T-Slot Bolt	1
1	B935DT	Drain Trough Out Jan. '74	1
1	B6035DT	Drain Trough	1
2	B935GA	Splash Guard	1
3	B935GB	Splash Guard	1
4	B935GD	Splash Guard	1
5	B935GL	Left Splash Guard	1
6	B935GR	Right Splash Guard	1
7	B935GS	Wet Wheel Guard	1
	B2035GR	Coolant Return	1
	B2035GW	Spacer Washer	1
	S609W	Thumb Screw	1
8	B6035N	Nozzle Assembly	1
	B6035NA	Body and Tube Assembly	1
	K518K	Control Knob	1
	K518S	Valve Shaft	1
	S632NT	Tube	1
	8011	O-Ring	1
	10-32 x 3/16	Hex Socket Set Screw	1
9	B935NB	Bracket	1
10	B935NP	Nozzle Stud	1
11	B935NS	Guard Stud	1
12	B935NT	T-Slot Plate	1
13	BA931H76	Plastic Hose (1/2)	1
	BA967H28	Flexible Conduit (1/2)	1
	BA967Y84	Power Wire	2-1 Ph., 3-3 Ph.
14	S732DC	Drain Cap	1

Index No.	Part No.	Description	Quan. Req.
15	B2035DH	Drain Hose (1 1/8)	1
	B6035DS	Drain Spout	1
16	S632H	Hanger	2
17	S632TA	Tank Assembly	1
18	S632TC	Cover	1
19	S635AH	Pump Assembly (115V, 1 Ph.)	1
	S635EH	Pump Assembly (230V, 3 Ph.)	1
	S635GAH	Pump Assembly (440V, 3 Ph.)	1
	S635KH	Pump Assembly (230V, 1 Ph.)	1
	75-201	Connector Straight (1/2")	1
	7610K2	Switch	1
20	HP11	Hose Clamp (on Guard)	1
21	HP12	Hose Clamp (on Tank)	1
22	HP16	Hose Clamp	1
	10-32 x 1/2	Round Head Machine Screw (HB)	4
	1/4 x 1/2 NF	Hex Cap Screw (HB)	2
	1/4 x 3/4 NF	Hex Cap Screw (HB)	2
	1/4 x 1/2 NF	Hex Socket Cap Screw	4
	3/16 x 1/2 NC	Hex Socket Cap Screw	1
	3/16 x 1 NC	Hex Socket Cap Screw	1
	3/16 x 7/8 NF	Hex Socket Cap Screw	4
	10-32	Hex Nut (HB)	4
	3/8 NC	Hex Nut (H)	1
	1/2 NF	Hex Jam Nut (HB)	1
	3/16	Lock Washer	4
	3/8 NF	Washer (H)	1
	1/2 NF	Washer (HB)	1
	3/16 NF	Washer (HB)	1
	No. 1111	Rubber Pads	2

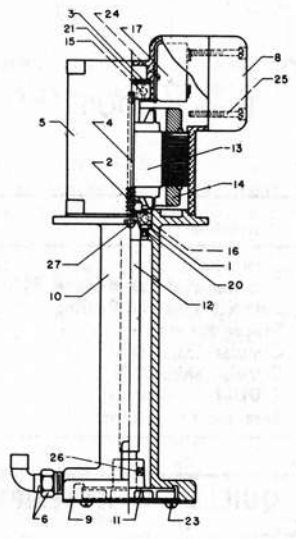

S635AH Pump Assembly, 115V, 1 Ph., 60 Cycle
S635EH Pump Assembly, 220V, 3 Ph., 60 Cycle
S635GAH Pump Assembly, 440V, 3 Ph., 60 Cycle
S635KH Pump Assembly, 230V, 1 Ph., 60 Cycle

Index No.	Part No.	Description	Quan. Req.
1	B637W	Thrust Ring	1
2	B6043AS	Field Positioner (all 1 Ph.)	2
2	B6043EP	Field Positioner (440V)	2
2	R55FP1/2	Field Pos. (230V, 3 Ph.)	2
3	B943AT	Thrust Plate	1
4	B943MDE	Stud Offset (115V, 1 Ph.)	2
4	B943MDL	Stud Offset	2
5	B943MH	Motor Housing	1
5	B6043MH	Motor Hsg. (115V, 1 Ph.)	1
6	BA933G	90° Elbow	1
7		Data Plate	1
8	B943BL	Switch Box (Lower 115V)	1
8	B943BU	Switch Box (Upper 115V)	1
8	S635B	Switch Box	1
9	S635C	Impeller Cover	1
10	S635H	Pump Housing	1
11	S635R	Impeller	1
12	S635S	Pump Shaft	1
12	S635SL	Pump Shaft (115V)	1
13	K10KG26	Field (220V, 3 Ph., 60 Cy.)	1

Index No.	Part No.	Description	Quan. Req.
13	K10KG27	Field (440V, 3 Ph., 60 Cy.)	1
13	KH10NG12	Field (115V, 1 Ph., 60 Cy.)	1
13	KH10NG32	Field (220V, 1 Ph., 60 Cy.)	1
14	K10KG26	Rotor (220V, 3 Ph., 60 Cy.)	1
14	K10KG27	Rotor (440V, 3 Ph., 60 Cy.)	1
14	KH10NG12	Rotor (115V, 1 Ph., 60 Cy.)	1
14	KH10NG32	Rotor (220V, 1 Ph., 60 Cy.)	1
15	39KVTD	Ball Bearing	1
16	202KLL3	Ball Bearing	1
17	91252-45	Start. Switch (115V, 1 Ph.)	1
17	91252-250	Start. Switch (220V, 1 Ph.)	1
19	31881	Terminal (1 Ph. only)	2
20	63 x 87	Seal (3/8 x 1 1/8 x 3/16)	1
21	SZ	Adjusting Spring	1
23	10-32 x 3/8	S. T. Rd. Hd. Screw (NP)	4
24	8-32 x 3/8	Rd. Hd. Mach. Sc. (NP)	2
25	8-32 x 1 1/8	Rd. Hd. Mach. Sc. (HB)	2
27	8-32	Acorn Nut—Light (NP)	2
	BA967CP	Plug	1
	73B	Bryant Wire Conn.	1
	6502	Cord Grip Conn.	1

B935-15 COOLANT ATTACHMENT

This attachment is similar to the B935 except for S612-233 (15 gallon) Tank Assembly and Pump Assemblies. The parts listed below refer to photographs on page 10. The S612-233 parts are listed in the center of this page and the Pump Assemblies are listed at the bottom of this page.

Index No.	Part No.	Description	Quan. Req.	Index No.	Part No.	Description	Quan. Req.
	A657B	T-Slot Bolt	1	14	S732DC	Drain Cap	1
1	B6035DT	Drain Trough	1	15	B2035DH	Drain Hose (1 1/8")	1
2	B935GA	Splash Guard	1		B6035DS	Drain Spout	1
3	B935GB	Splash Guard	1		S612-233	Tank Assembly (see parts list below)	1
4	B935GD	Splash Guard	1	19	S1635A	Pump Assembly (115V, 1 Ph.)	1
5	B935GL	Left Splash Guard	1		S1635E	Pump Assembly (230V, 3 Ph.)	1
6	B935GR	Right Splash Guard	1		S1635GA	Pump Assembly (440V, 3 Ph.)	1
7	B935GS	Wet Wheel Guard	1		75-201	Connector Straight (1/2")	1
	B2035GR	Coolant Return	1	20	7610K2	Switch	1
	B2035GW	Spacer Washer	1	21	HP11	Hose Clamp (on Guard)	1
	S609W	Thumb Screw	1	22	HP12	Hose Clamp (on Tank)	1
8	B6035N	Nozzle Assembly	1		HP16	Hose Clamp	1
	B6035NA	Body and Tube Assembly	1		10-32 x 1/2	Round Head Machine Screw (HB)	4
	K518K	Control Knob	1		1/4 x 1/2 NF	Hex Cap Screw (HB)	2
	K518S	Valve Shaft	1		1/4 x 3/4 NF	Hex Cap Screw (HB)	4
	S632NT	Tube	1		1/4 x 1/2 NF	Hex Socket Cap Screw	2
	8011	O-Ring	1		3/16 x 1/2 NC	Hex Socket Cap Screw	1
	10-32 x 3/16	Hex Socket Set Screw	1		5/16 x 1 NC	Hex Socket Cap Screw	1
9	B935NB	Bracket	1		3/16 x 3/8 NF	Hex Socket Cap Screw	4
10	B935NP	Nozzle Stud	1		10-32	Hex Nut (HB)	4
11	B935NS	Guard Stud	1		3/8 NC	Hex Nut (H)	1
12	B935NT	T-Slot Plate	1		1/2 NF	Hex Jam Nut (HB)	1
13	BA931H76	Plastic Hose (1/2")	1		3/16 STD.	Lock Washer	4
	BA967H28	Flexible Conduit (1/2")	1		3/8 NF	Washer (H)	1
	BA967Y84	Power Wire	2-1 Ph., 3-3 Ph.		1/2 NF	Washer (HB)	1
					5/16 NF	Washer (HB)	1
					No. 1111	Rubber Pads	2

S612-233 TANK ASSEMBLY

You may order this unit as a replacement for any Lee Coolant Attachment. It includes items listed below, but not the Pump, Splash Guards, Nozzle Assembly, etc., which are parts of original Coolant Attachment.

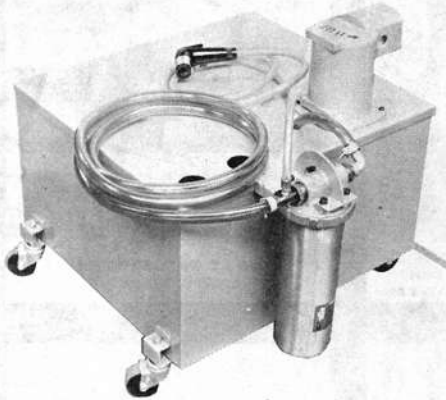

Part No.	Description	Quan. Req.	Part No.	Description	Quan. Req.
BA931H17	Hose, 17"	1	S612-232F	Flushing Attachment	1
BA931H84	Hose, 84"	1	3/4 - 3/8	Reducer Bushing	2
BA933G	Elbow	1	1/4 x 5/8 NC	Hex Cap Sc. H.B.	4
S612-44	Hose Coupling	1	1/4 STD.	Lock Washer	4
S832TA	Tank Assbly., 15 gal.	1	HP11	Hose Clamp	3
S612-232C	Cover Assembly	1	HP12	Hose Clamp	1
CT101	Cuno Filter	1	2278-L1	Replacement 50 Micron Filter Cartridge Available	
1-2251-51-2	Caster	4			

S1635A Pump Assembly, 115V, 1 Ph., 60 Cycle S1635E Pump Assembly, 220V, 3 Ph., 60 Cycle S1635GA Pump Assembly, 440V, 3 Ph., 60 Cycle

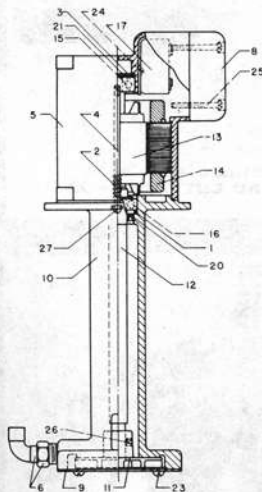

Index No.	Part No.	Description	Quan. Req.	Index No.	Part No.	Description	Quan. Req.
1	B637W	Thrust Ring	1	13	K10FG22	Field (440V, 3 Ph., 60 Cy.)	1
2	B6043AP	Field Positioner	2	13	KH10FG11	Field (115V, 1 Ph., 60 Cy.)	1
3	B943AT	Thrust Plate	1	14	K10FG21	Rotor (220V, 3 Ph., 60 Cy.)	1
4	B943MDL	Stud Offset	2	14	K10FG22	Rotor (440V, 3 Ph., 60 Cy.)	1
5	B943MH	Motor Housing	1	14	KH10FG11	Rotor (115V, 1 Ph., 60 Cy.)	1
6	BA933G	90° Elbow	1	15	39KVTD	Ball Bearing	1
7	S1635AN	Data Plate	1	16	202KLL3	Ball Bearing	1
7	S1635EN	Data Plate	1	17	91252-45	Start. Switch (115V, 1 Ph.)	1
7	S1635GAN	Data Plate	1	17	91252-250	Start. Switch (220V, 1 Ph.)	1
8	S635B	Switch Box	1	20	63 x 87	Seal (5/8 x 1 1/4 x 3/8)	1
9	S635C	Impeller Cover	1	21	5Z	Adjusting Spring	1
10	S635H	Pump Housing	1	23	10-32 x 3/8	S. T. Rd. Hd. Screw (NP)	4
11	S635R	Impeller	1	24	8-32 x 3/8	Rd. Hd. Mach. Sc. (NP)	2
12	S635S	Pump Shaft	1	25	8-32 x 1 1/8	Rd. Hd. Mach. Sc. (HB)	2
13	K10FG21	Field (220V, 3 Ph., 60 Cy.)	1	26	1/4 x 1/4 NF	Hex Socket Set Screw	1
				27	8-32	Acorn Nut—Light (NP)	2

Fixtures Than Any Other Grinder Manufacturer

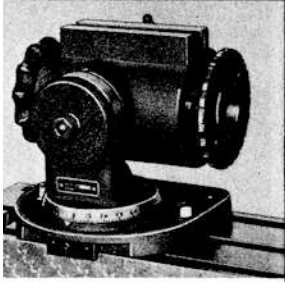

B942 SENSITIVE WORK HEAD

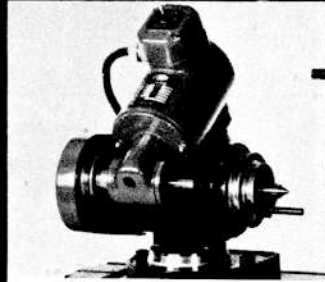

B943 MOTOR DRIVEN WORK HEAD

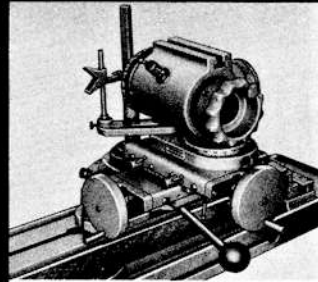

BA986 RADIAL GRINDING FIXTURE

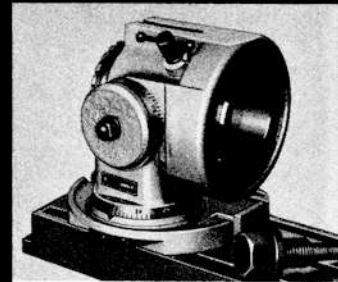

B992 SENSITIVE WORK HEAD

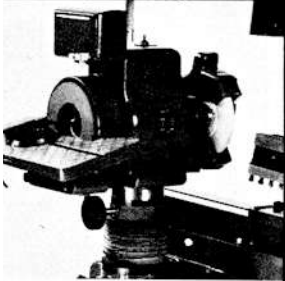

B945 TILTING TABLE ATTACHMENT

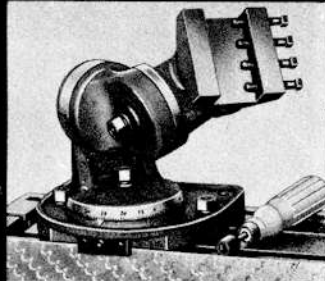

B989 UNIVERSAL WORK HOLDING FIXTURE

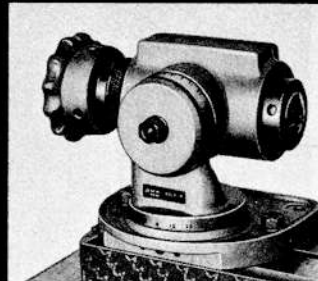

B947 TAP GRINDING FIXTURE



B979 UNIVERSAL ANGULAR MOTOR MOUNT

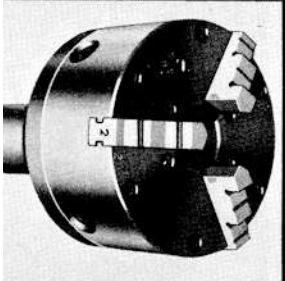

**CHUCKS
44 4" 6-JAW ADJUSTRU
46 4" 3-JAW ADJUSTRU**

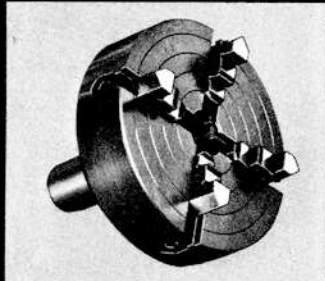

**B844E 6" INDEPENDENT 4-JAW CHUCK
NO. 11 B & S ARBOR**



**2689 WAY LUBE QT. CAN
2670 SPINDLE OIL PT. CAN
2645 GRAY HAMMER SPRAY CAN**

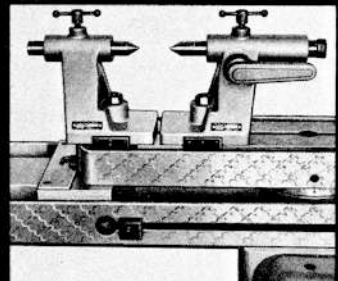

B922 TAILSTOCKS (MATCHED SET)

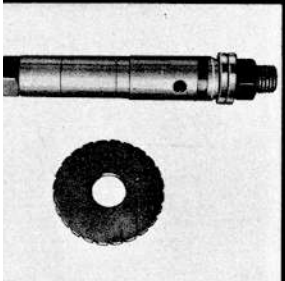

148 SERIES CUTTER AND 10B GRINDING ARBORS

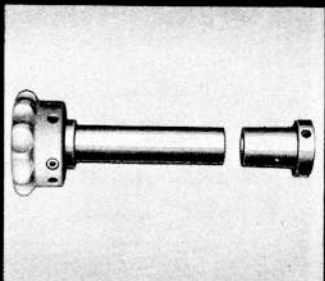

B641 AND B941 COLLET FIXTURE

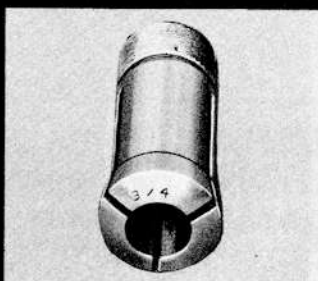

B641C COLLETS FOR B641 & B941 FIXTURES

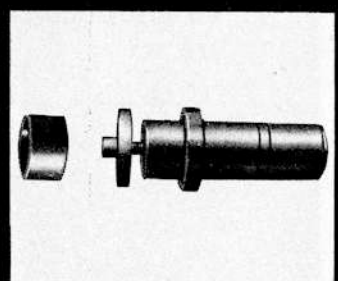

SHELL END MILL AND CUTTER ARBOR



B641K

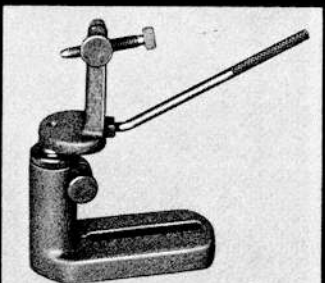

B269

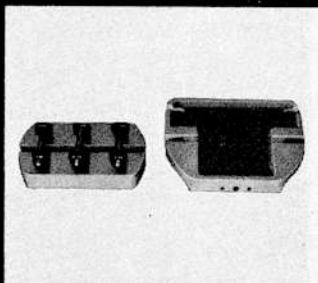

B918 TWO IN. GRINDING BLOCKS

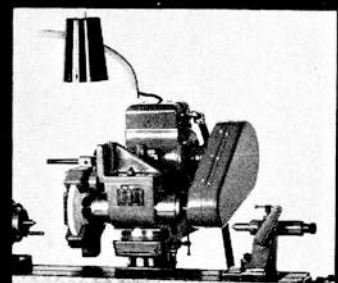

B955 UNIVERSAL GRINDING HEAD