

The Installation and Leveling of the Lathe

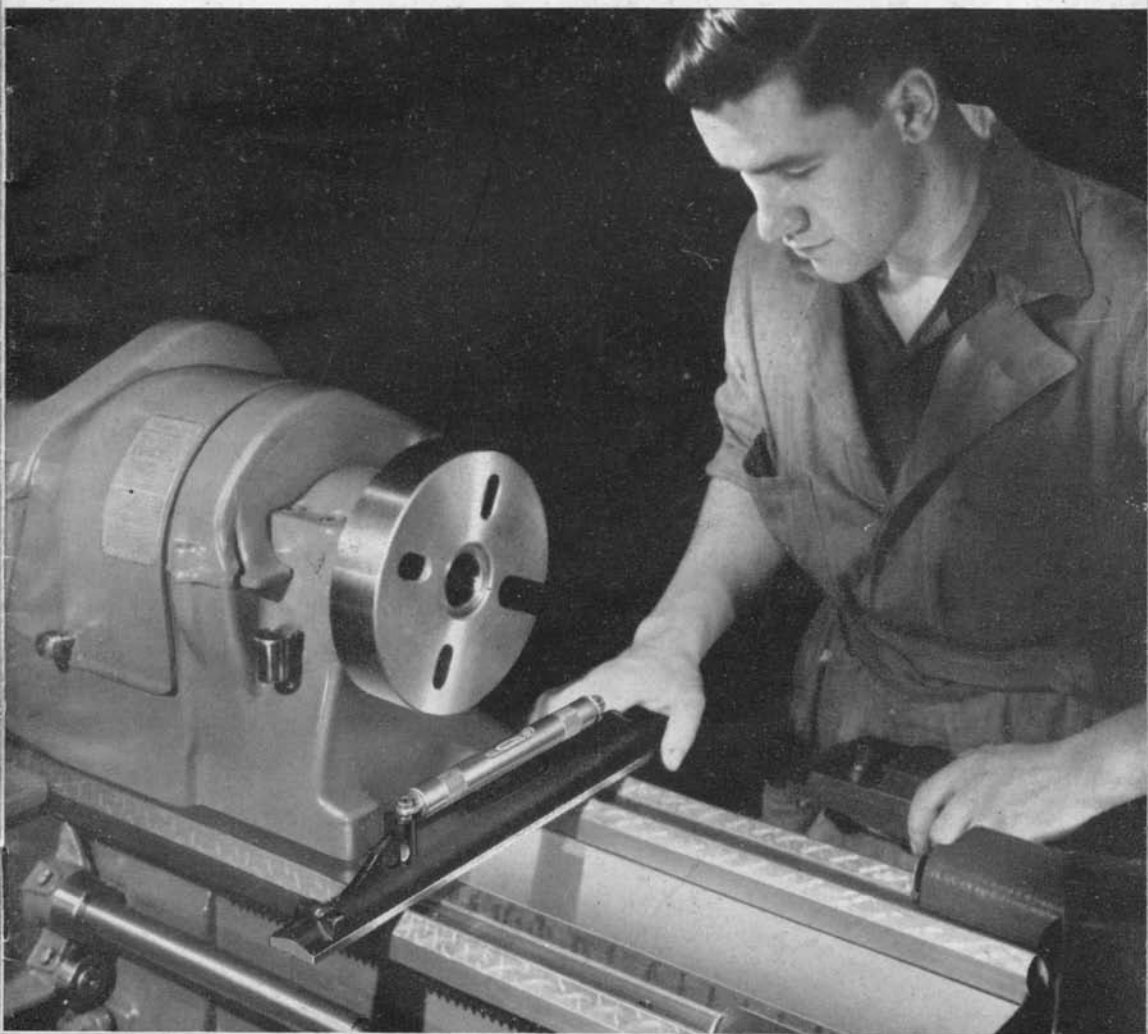

SOUTH BEND LATHE WORKS

425 EAST MADISON STREET
SOUTH BEND 22, INDIANA, U. S. A.

HOW TO GET THE MOST OUT OF YOUR LATHES

A Series of Bulletins on the Care and Operation of Metal Working Lathes

These bulletins are supplied in any reasonable quantity without charge to shop instructors and others who are interested in the care and operation of the lathe.

Bulletin H-1—"Keep Your Lathe Clean". Shows how protecting the lathe from abrasive dirt will increase production, reduce scrap, and lengthen the life of the lathe.

Bulletin H-2—"Oiling the Lathe". Explains the importance of adequate lubrication.

Bulletin H-3—"The Installation and Leveling of the Lathe". Gives detailed information on the correct installation and leveling of the lathe for precision work.

Bulletin H-4—"Keep Your Lathe in Trim". Tells how to make all necessary adjustments, check power supply, protect lathe from abuse, and keep lathe in best operating condition.

The Installation and Leveling of the Lathe

Prepared by

Technical Service Department

South Bend Lathe Works

Bulletin No. H-3

Seventh Reprint 1946, Copyright 1942 by

SOUTH BEND LATHE WORKS

425 EAST MADISON STREET

South Bend 22, Indiana, U. S. A.



Fig. 1. To do accurate work, a lathe must be properly installed and leveled.

THE INSTALLATION AND LEVELING OF THE LATHE

Importance of Correct Installation

The correct installation and leveling of the lathe is more important than is generally realized. Precision tolerances can be maintained only when the lathe is mounted on a solid foundation and properly leveled. The most efficient production can be attained when the lathe is properly located in the shop, with good lighting facilities and ample working space for the operator.

When the time required to install the lathe is compared to the length of time it will be in service, it is easy to see that every effort that is put into its proper installation will be more than repaid in better service and greater satisfaction from the use of the lathe. Careful planning in preparation for the installation of a new lathe is therefore justified by the resultant efficiency.

A floor plan of the shop room drawn to scale, and paper or cardboard cutouts of each machine made to the same scale as the floor plan, are convenient for working out the arrangement of the machinery. The cutouts may be shifted around until a satisfactory arrangement is obtained, and then fastened in place with thumb tacks or push pins. See Fig. 4, page 7.

Unpacking A New Lathe

A lathe is a precision tool which should be carefully handled at all times. No attempt should be made to unload a lathe from a freight car or truck unless adequate handling facilities are available. Under no circumstances should the lathe be rolled over or dropped. Rough handling, due to inadequate unloading facilities, may seriously impair the accuracy of the lathe, or even cause breakage of important parts.

A new lathe should be carefully unpacked and installed so that all of the fine accuracy built into the lathe by the manufacturer will be retained. A nail puller is preferable to a hammer or pinch bar for removing nails from the crate. Care should be taken to avoid damaging the lathe by accidentally striking it with a hammer, crowbar or other tools.

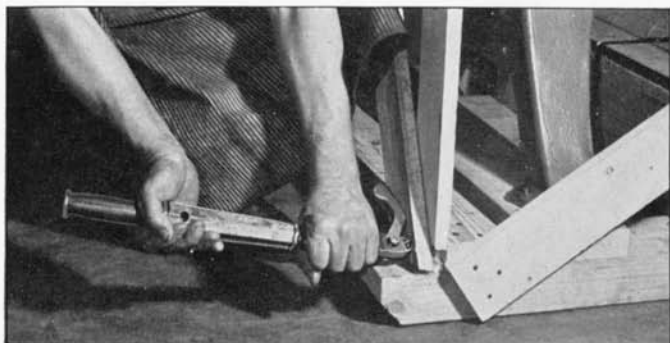

Fig. 2. To avoid accidental damage to lathe, use a nail puller instead of a hammer to remove crate.

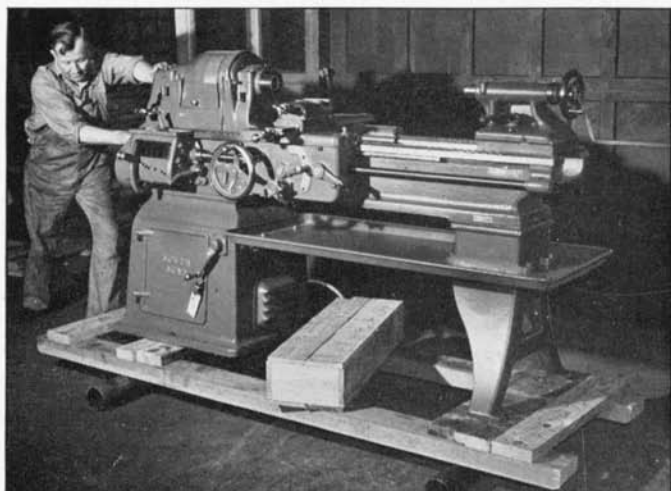

Fig. 3. The skids should not be removed until the lathe has been moved to the location in the shop where it is to be used.

To remove the crate from the lathe, first take off the diagonal braces on each side; then pull out all nails securing the crate to the skids. The entire crate can then be lifted up, leaving the lathe on the skids. The skids should not be removed until the lathe has been moved to the location in the shop where it is to be installed.

After removing the crate, the waterproof paper and other wrapping material can be removed, and boxes containing extras

such as chucks, tools and attachments can be opened. All packing material should be carefully inspected for small parts, instruction books, etc. Instructions packed with the lathe should be studied before the lathe is set up and leveled.

A stiff brush and kerosene can be used to remove the grease and oil used to prevent the lathe from rusting in transit. After cleaning with kerosene the lathe should be wiped thoroughly with a clean cloth. All unpainted surfaces should immediately be coated with a film of good machine oil to prevent rusting. If the finished surfaces are kept clean and well coated with oil, the lathe will retain its new appearance indefinitely. If the lathe is not placed in service at once it should be covered with canvas or waterproof paper to protect it from dust.

Lighting is Important

Good lighting is very important in the machine shop. Correct illumination, both natural and artificial, results in better workmanship, greater accuracy, and less spoilage of work. By reducing eyestrain, the efficiency of the operator is increased and better production can be maintained.

The lathe should be placed so that the outside windows will be to the right and rear of the operator, and the light will shine



Fig. 4. Planning the arrangement of shop equipment with floor plan and cardboard cutouts.

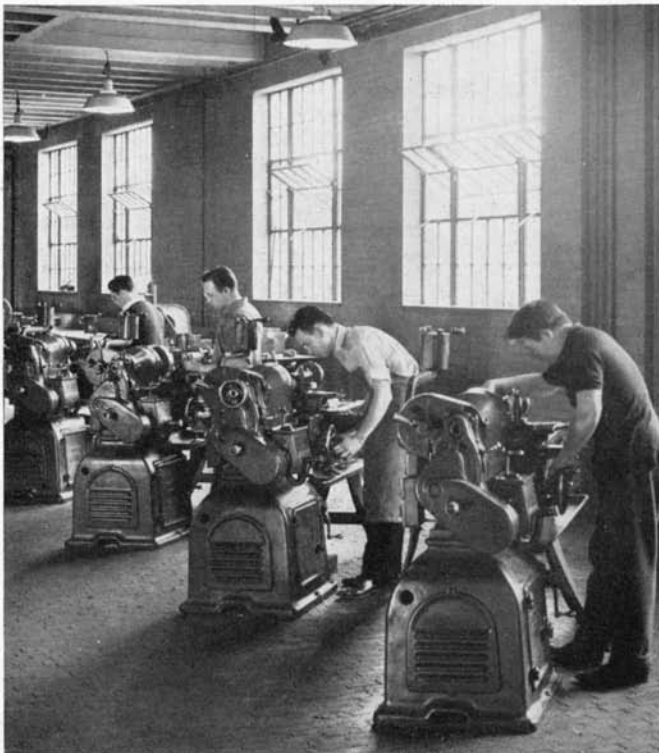

Fig. 5. Lathes installed at correct angle to take full advantage of daylight from outside windows and provide ample working space for the operator.

over the operator's right shoulder. It is preferable to place the lathe at an angle, with the tailstock end nearer to the windows so that the work will not be in the shadow of the lathe chuck or the operator. See Figs. 5 and 8.

Good artificial lighting should be provided in addition to daylight so that work can be done just as well after dark as in the daytime. An illumination of 50 to 100 foot candles at working level is recommended for machine shops by the American Standards Association. General illumination of not less than 20 foot candles can be used providing each machine is equipped with a well shaded supplementary light that will provide the required illumination at the working level.



Fig. 6. Good general illumination is provided by fluorescent lights in deep reflectors mounted well above the line of vision.

The light source should be located so that the light will not shine directly into the operator's eyes. Fluorescent lights in deep reflectors mounted well above the line of vision are preferable for general illumination. Shadows are softer and reflected glare is less pronounced with this type of lighting. Light-colored

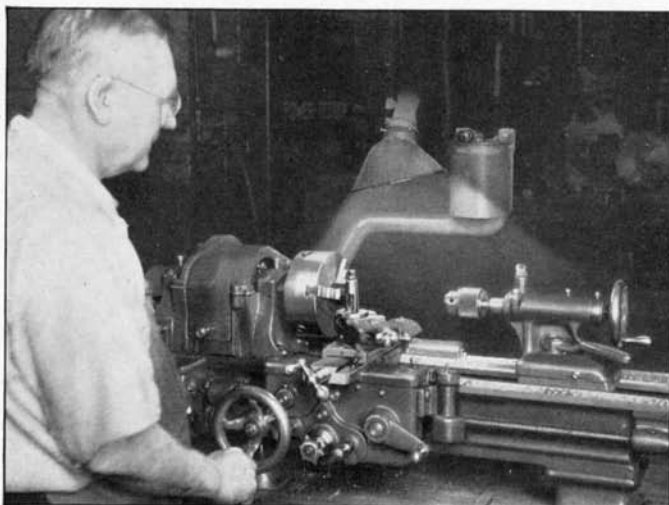

Fig. 7. Supplementary lights should be well shaded to avoid line of vision glare.

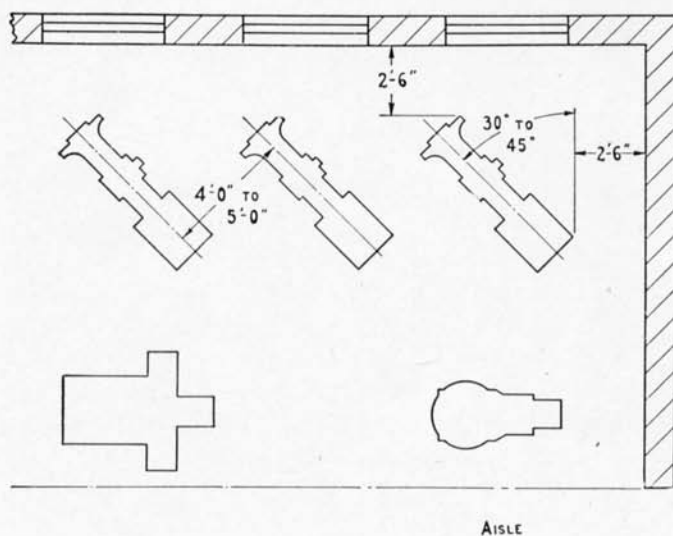

Fig. 8. Lathes arranged to take full advantage of daylight and provide ample working space for the operator.

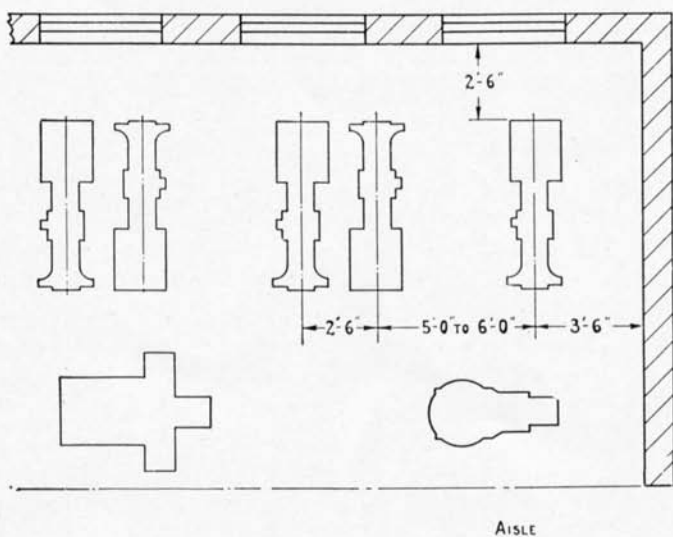

Fig. 9. Lathes placed back to back to save floor space.

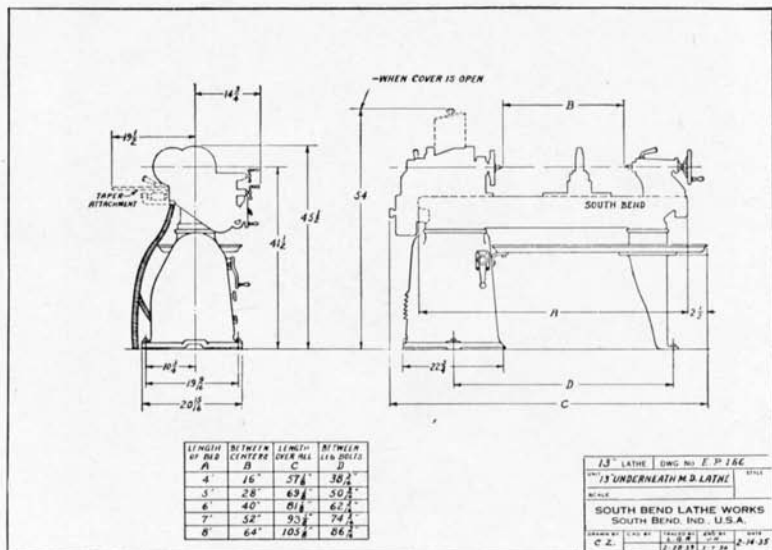

Fig. 10. Erection plan of lathe showing amount of floor space required.

walls and ceilings greatly improve illumination through their ability to reflect the light. Line of vision glare from either daylight or artificial light should be avoided.

Floor Space Required

The floor space required for the lathe can be ascertained from the erection plan which is packed with the lathe. See Fig. 10. The amount of working space required around the lathe depends on the type of work that is to be done. When the lathe is to be used for bar work, sufficient space must be allowed for the stock to extend beyond the left end of the lathe. When the lathe is used on production operations, space must be provided for stacking unfinished and finished parts.

The arrangement of the lathe in relation to other machines in the shop will depend on the type of shop in which it is used. Where a number of lathes are installed as a unit for either production or toolroom operations, the arrangement shown in Fig. 8 is convenient, practical and efficient. This arrangement provides ample working space for the operator and takes full ad-



Fig. 11. When the lathe is used on production operations space must be provided for stacking unfinished and finished work.

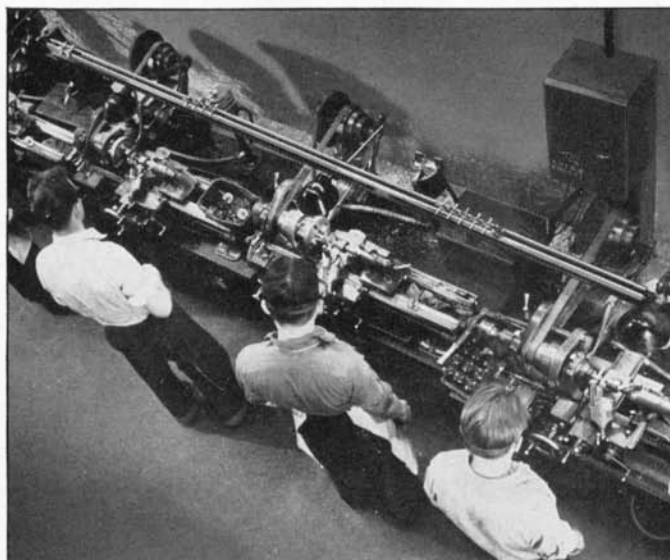

Fig. 12. A group of lathes arranged in sequence of operations, with conveyor (above lathes) to carry parts from machine to machine.



Fig. 13. Lathes placed back to back to save floor space.

vantage of light from outside windows. When floor space is at a premium, the lathes may be placed back to back as shown in Figs. 9 and 13. This permits installing a maximum number of machines in a given space.

When large production is planned and the lathe is operated continuously on a single job, it is sometimes advisable to place the lathe adjacent to other lathes or other types of machines which may be used for performing other operations on the same part. In this type of shop, the arrangement of machines depends on the sequence of operations and the type of conveyor system or other equipment used for transporting the parts from one machine to another. See Fig. 12.

Solid Floor Required

It is very important that the lathe be set on a substantial support, preferably a solid concrete floor or foundation not less than six inches thick. If the lathe is set on a wood floor, it must be one that is substantially constructed. When there is any danger of the floor sagging or if there is excessive vibration, the floor should be well braced beneath the lathe.

A precision level can be used for checking the strength of the floor. If the bubble in a precision level placed on the floor

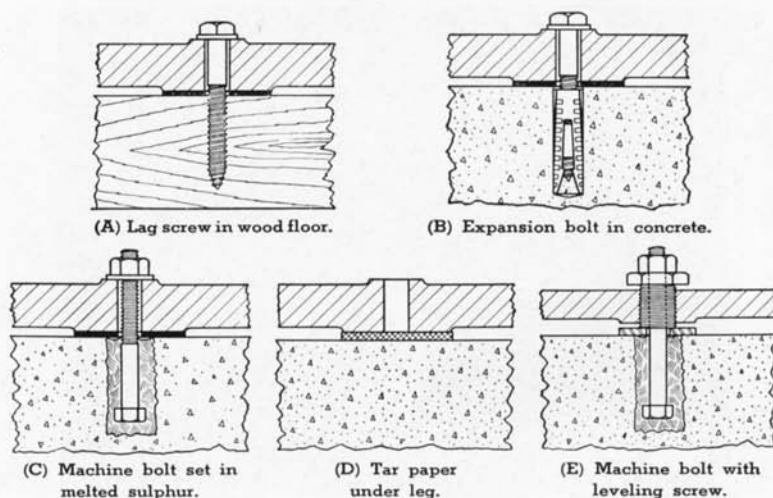

Fig. 14. Methods of securing lathe to floor.

shows a noticeable movement when a hand truck with a normal load is pushed past the location where the lathe is to be installed, the floor should be reinforced, or it should be cut away and a concrete foundation installed.

Movement of the floor due to shifting weights or atmospheric conditions makes it difficult to keep the lathe properly leveled, which is essential to accurate work. For this reason, a separate foundation for the lathe, with clearance between the lathe foundation and the floor, is sometimes used in laboratory shops where extremely precise work is done on the lathe.

Securing the Lathe to the Floor

If a lathe is not fastened to the floor it may shift and be thrown out of level. All lathes should therefore be secured to the floor in such a way that they cannot shift from the position in which they were installed.

The lag screws used to fasten the lathe to the skids during shipment can be used to secure the lathe to a wood floor. Holes $\frac{1}{16}$ " to $\frac{1}{8}$ " smaller than the outside diameter of the thread on the lag screw should be drilled into the floor before inserting the screws. This will prevent the floor boards from splitting and the screws will hold better. A little soap on the thread will



Fig. 15. The lathe must be carefully leveled, using shims between the legs and the floor.

make the lag screws much easier to turn in hard wood.

If the lathe is to be set on a concrete floor or foundation, mark the location of the bolt holes and drill holes in the concrete with a star drill. Expansion bolts can be used for fastening the lathe down to a concrete floor, or machine bolts can be set head down, using melted lead or melted sulphur as a binder. The drilled holes must be perfectly dry and free from all traces of moisture before pouring melted lead or sulphur.

Some lathes have leveling screws through which the hold-down bolts pass, as shown in (E) Fig. 14. The leveling screws simplify the leveling of the lathe as they eliminate the necessity of using shims. A steel washer, $\frac{1}{4}$ " to $\frac{1}{2}$ " thick, should be placed between the leveling screws and the floor.

Some very large industries use tarpaper to fasten machines to concrete floors. No hold-down bolts are used, but shims made of ordinary builders' tarpaper are placed beneath the legs of the machine. The tar squeezes out and cements the machine securely to the floor. This effectively prevents the machine from shifting, but makes it easy to move if it is necessary to change its location.

Concrete floors that are in poor condition or are too thin to

provide a solid support should be cut away and replaced with a substantial concrete foundation for the lathe. When a wood flooring has been laid over concrete, it is best to remove the wood underneath the lathe and build up the concrete to the level of the wood flooring. Under no condition should the lathe be set in concrete, as this would make future leveling adjustments impossible.

Leveling the Lathe

The lathe must be carefully leveled, using shims between the legs and the floor. If shims are not used, the weight of the lathe may not be supported evenly on all four legs. This will cause the lathe bed to be twisted, throwing the headstock and tailstock out of alignment and causing the lathe to turn and bore a taper. It will also cause the tailstock center point to shift as the tailstock is moved along the lathe bed, necessitating constant readjustment of the tailstock top set-over. If the lathe is not properly leveled it cannot be expected to turn out accurate work.

Shims for leveling the lathe should be made of metal, tarpaper or other material not affected by moisture or atmospheric conditions. Tapered metal shims are best. Wood shims are not desirable as they swell and shrink as the moisture content of the air changes and may even deteriorate or compress with age. When placing shims under the cabinet leg at the headstock end of the lathe, use the shims only at the bolt pads. There should be clearance under the cabinet leg except where the bolts go through the leg into the floor. A wood molding may be installed around the bottom of the cabinet leg to prevent chips from working under it.

Leveling Turret Lathes

Turret Lathes must be leveled in the same way and just as carefully as a Precision Toolroom Lathe. If a turret lathe is not level, the headstock and the turret slide are thrown out of alignment, causing the turret tools to be thrown off center and making it impossible to do accurate work.

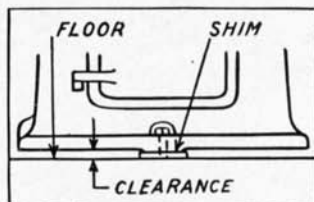

Fig. 16. Shims should be used only at bolt pads, leaving clearance elsewhere under cabinet leg.

Use a Precision Level

A precision level should be used for leveling the lathe. The level should be at least 12 inches long and sufficiently sensitive to show a distinct movement of the bubble when a .003" shim is placed under one end of it. A carpenter's level, a combination square level, or an ordinary machinist's level cannot be used for leveling a lathe because they do not have sufficient sensitivity.

Careful handling is necessary when using a precision level. Never hold the level with the hand over the glass tube as the heat from the hand may cause the vial to be distorted and affect the action of the bubble. After placing the level on the lathe bed, remove the hand and allow at least one-half minute for the bubble to come to rest before taking the reading.

Before starting to level the lathe make sure that the bed ways are thoroughly cleaned of all dirt, chips, rust or other foreign matter. Also examine the tops of the bed ways for burrs, and if any burrs are located remove them carefully with a fine mill file.

Longitudinal Leveling

The lathe should first be leveled longitudinally, placing the level on the bed parallel with the ways near the center of the lathe. Loosen all floor bolts and shim under the lathe until the bed



Fig. 17. A precision level must be used for leveling the lathe.

is approximately level longitudinally. This leveling is not critical as it does not affect the accuracy of the lathe.

Transverse Leveling

When the lathe is approximately level longitudinally, place the level across the bed ways immediately in front of the headstock, as shown in Fig. 15, page 15. Allow the bubble to come to rest, and notice the position of the bubble. Then, without turning the level end for end, move the level to the tailstock end of the bed and repeat the operation. Shims should then be placed beneath the lathe at the points indicated by the level as being low. Check the leveling of the lathe at the headstock end and the tailstock end and readjust the shims until the lathe is perfectly level at both ends.

After the lathe has been properly leveled, carefully tighten the floor bolts, drawing them uniformly so that they will have an even tension. Check the leveling of the lathe after tightening the floor bolts, and make any necessary readjustments of the shims.

Leveling Bench Lathes

A bench lathe should be mounted on a substantially constructed bench; otherwise it will be impossible to keep the lathe level. A strong metal bench is preferable to a wood bench. If the bench is made of wood it should be built of heavy lumber with at least a 2" top.

The bench should first be securely bolted to the floor, using shims beneath the legs of the bench to compensate for any unevenness of the floor. The bench top should be approximately level. The bench lathe may then be leveled the same as a floor

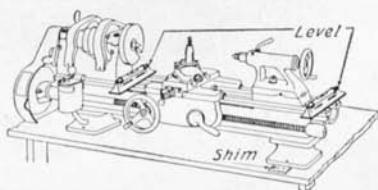

Fig. 18. Bench lathes are leveled by placing shims between the lathe and the bench.

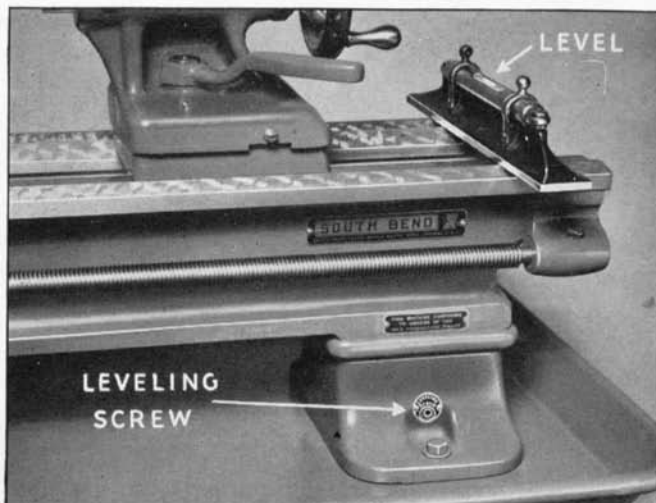

Fig. 19. Some bench lathes have leveling screws for making final leveling adjustments.

type lathe, except that the shims are placed between the top of the bench and the lathe.

Some bench lathes have leveling screws in the front and back of the right hand leg, as shown in Fig. 19. These screws may be adjusted alternately for making the final leveling adjustments. Both screws must be tightened securely when the leveling is completed. When mounted on a substantial steel bench, lathes having leveling screws can usually be leveled by shimming under the bench and adjusting the leveling screws, thus eliminating the use of shims between the bench top and the lathe.

Leveling Must Be Checked Periodically

There are many conditions which may throw the lathe out of level and make it necessary to check the leveling of the lathe periodically. If at any time the lathe does not do accurate work, one of the first things to check is the leveling. Even large buildings with substantial foundations may settle enough to cause trouble. The floors in wooden buildings are constantly shifting as a result of atmospheric conditions, high winds, shifting loads, etc. In many localities slight earthquakes may throw the lathe out of level even though the tremors are not severe enough to cause any noticeable damage.

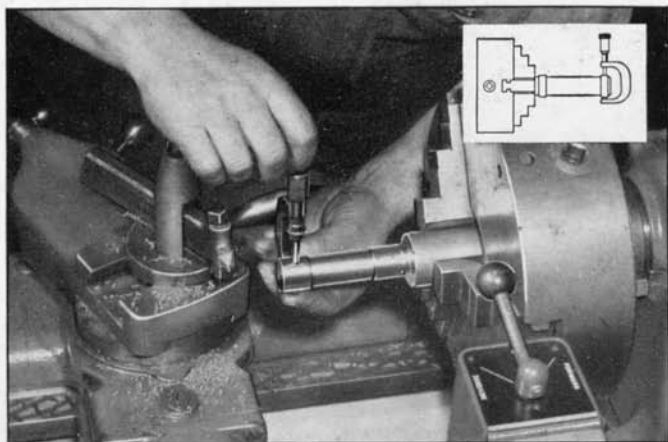

Fig. 20. A simple turning test can be used to check the leveling of the lathe.

Turning Test for Leveling

A simple turning test can be used to check the leveling of the lathe. This test can also be used to perfect the leveling of a lathe when it is impossible to secure a precision level.

To make the test, place a bar of steel one inch or larger in diameter in the chuck and machine two collars of equal diameter three or four inches apart. Then take a cut not exceeding .002" in depth across both collars, using a fine feed that will not crowd the bar away from the tool. The setting of the tool should not be changed while taking the cut across the two collars. A low spindle speed should be used to eliminate any possibility of the bar whipping.

Measure both collars with a micrometer, and if the diameters are equal the lathe is level. A difference between the diameters indicates that the lathe is not level and the tool is not traveling parallel to the longitudinal axis of the headstock spindle.

If the diameter of the outer collar is greater than that of the inner collar, shim under the front of the lathe at the tailstock end until both collars are turned to the same diameter. If the diameter of the inner collar is greater than that of the outer collar, shim under the back of the lathe at the tailstock end until both collars are turned to the same diameter.