

PRATT & WHITNEY

Model "C"

LATHES

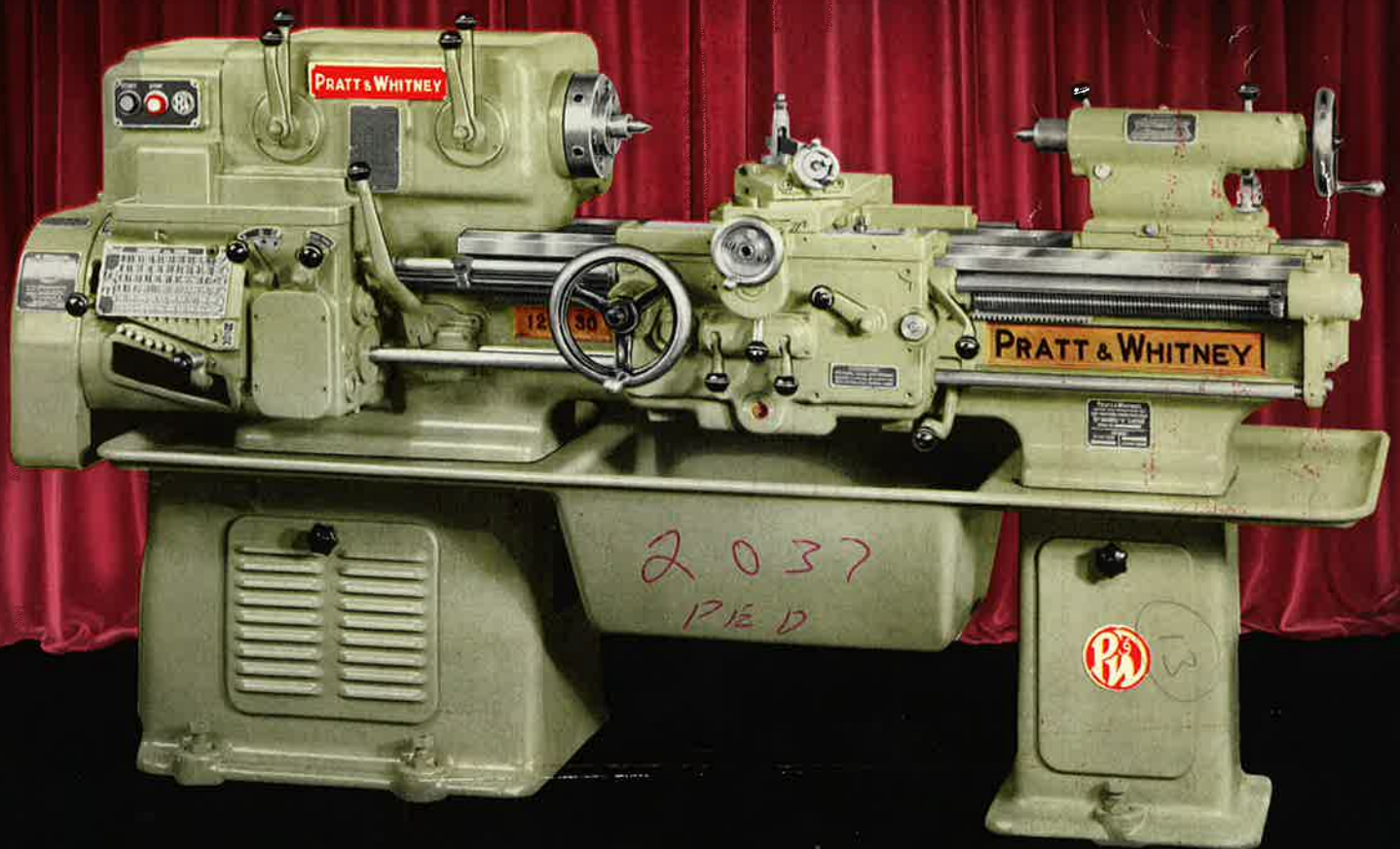

*... the Standard by which
all fine lathes are judged*

PRATT & WHITNEY

1. BUILT-IN PUSH BUTTON CONTROL for main power supply is conveniently located to operator's left hand.

2. 18 SPINDLE SPEEDS ranging from 14 to 1000 rpm, or a speed range of 21 to 1500 rpm can be furnished to order.

3. CAM-LOCK SPINDLE NOSE provides greater rigidity in holding chuck or face plate on spindle. Safer, truer running, more convenient mounting and removing — cannot "freeze" on.

4. DIRECT READING FEED DIALS graduated to give work diameter reductions in thousandths of an inch on the cross slide and on the compound rest.

5. CONVENIENT FEED REVERSING LEVER with synchronizing high speed reverse mechanism for lead screw and feed rod. Stops on reversing rod provide accurate automatic feed and thread knockoff in either direction.

6. EXTRA HEAVY TAILSTOCK mounted on separate bed ways from the carriage. Spindle has tang slot and is graduated for drilling to depth.

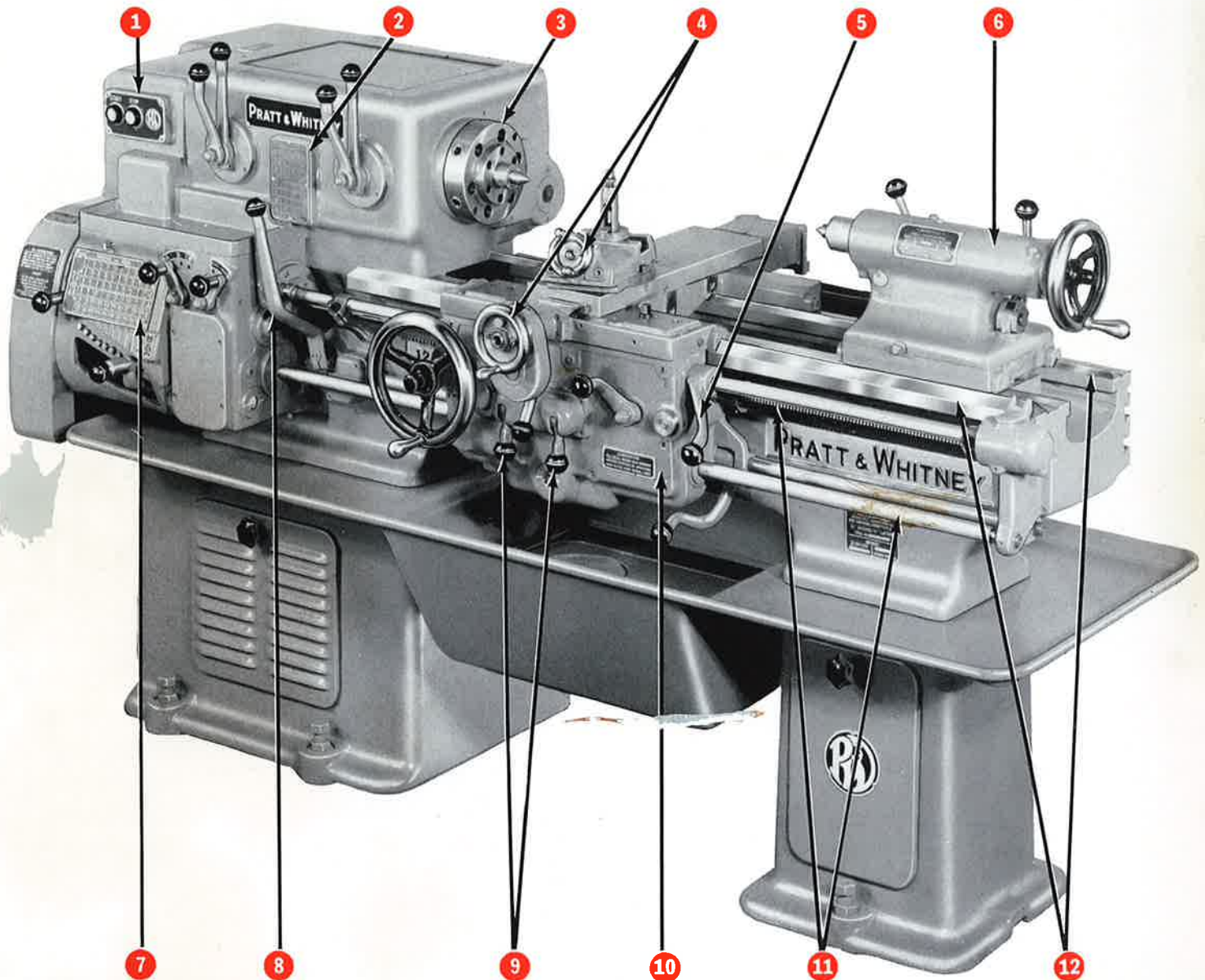

7. 60 THREAD CUTTING AND FEED CHANGES including 27 thds. per inch for $\frac{1}{8}$ " pipe thds. Easy selection from direct reading index plate and convenient controls.

8. MAIN DRIVE CLUTCH is multi-disc type with a friction brake for stopping quickly. Can be operated by levers at either the headstock or the apron.

9. QUICK-ACTION FEED CONTROLS for carriage and cross slide are not friction operated, but engage positively. Safety interlock prevents feed and lead screw engagement at same time.

10. REMOVABLE APRON FRONT allows adjustments to be made inside apron without having to remove apron assembly, lead screw, feed rod, etc.

11. PRECISION LEAD SCREW SEPARATE FROM FEED ROD. All normal cutting duty is taken by the splined feed rod, reducing wear to the lead screw used only for thread cutting. Super-precision ball thrust bearings prevent drunken threads.

12. FLAME-HARDENED AND PRECISION-GROUND BED WAYS provide permanent stability and accuracy.

MODEL "C" LATHES

13. RIGID BOX-TYPE BED has thick walls and heavy cross ribbing — cast of special close grain iron and stabilized to eliminate distortion.

14. EXCLUSIVE WEDGE-TYPE CLAMP on tailstock binds spindle from bottom at right angle to cutting tool.

15. TOOL REST SLIDE IS STEEL FORGING to prevent breaking out T-slot under heavy pressure as so often happens when cast iron is used.

16. BALL BEARING TAPER ATTACHMENT furnished as additional equipment, permits smooth, accurate taper turning and boring.

17. SPINDLE SUPPORTED AT THREE POINTS — at front in two preloaded super-precision ball bearings and at rear in anti-friction type needle bearing. Hollow spindle accommodates draw-back and collet sizes up to 1" on the 12" lathe and 1½" on the 16" lathe.

18. HEADSTOCK — gears are made of alloy steel and are hardened and ground. Gear shafts are multiple splined and mounted in antifriction bearings throughout. Bed is extended at rear to avoid overhanging headstock.

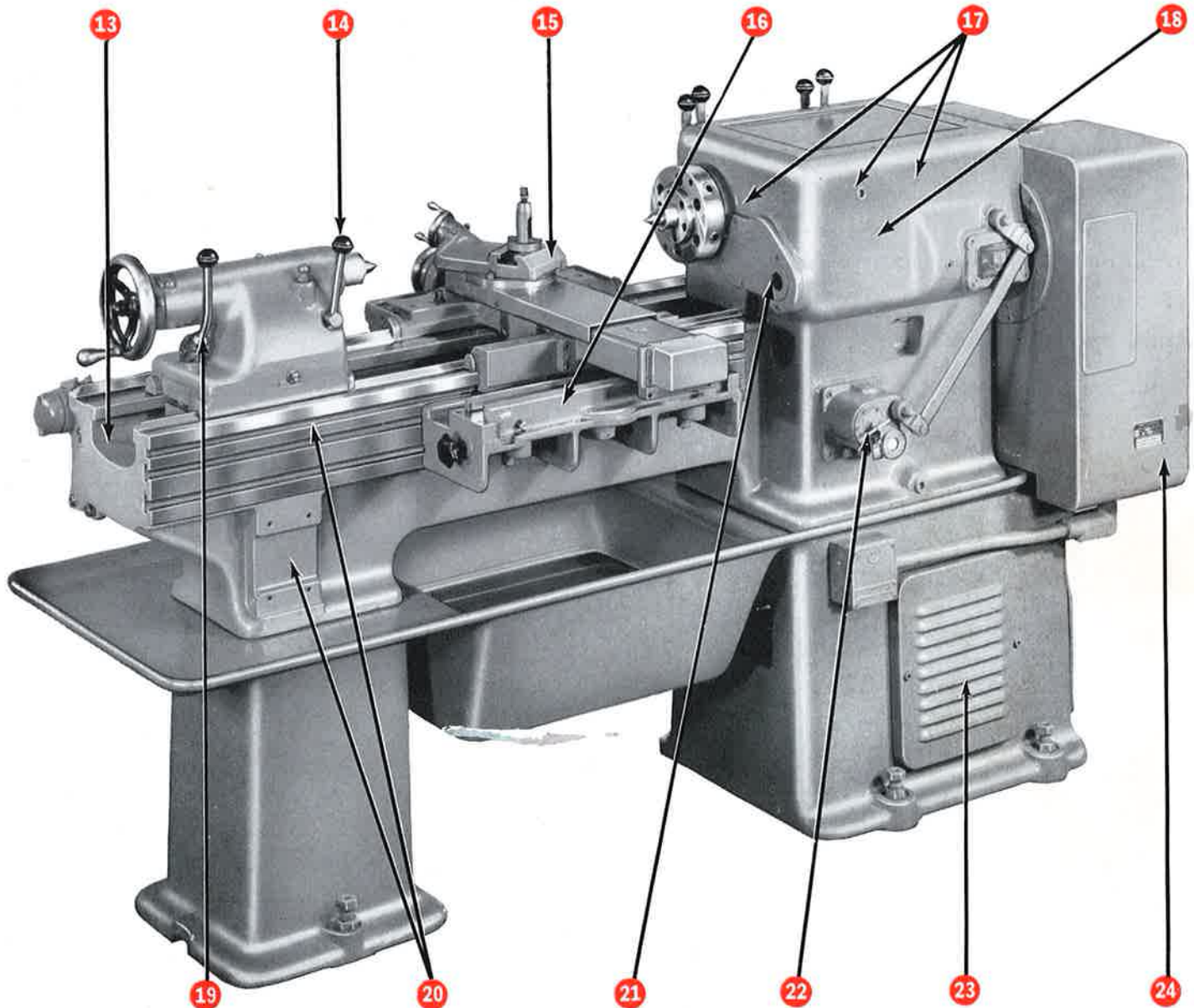

19. HEAVY BINDER locks tailstock solidly in position. Spring release prevents dragging.

20. EVERY BED MACHINED FOR ATTACHMENTS such as coolant pump, taper attachment, etc. (see pages 14-19). This additional equipment can be easily assembled at any time.

21. OIL SIGHT WINDOW — Visual assurance that lubrication is being delivered to Headstock gearing.

22. FILTERED LUBRICATION TO HEADSTOCK— a continuous rain of clean filtered oil pours over every gear while machine is in motion. Filtered oil is also pumped to all shaft and spindle bearings.

23. DRIVING MOTOR MOUNTS INSIDE CABINET LEG protected from dirt and chips yet easily accessible through removable cover. Multiple V-belts carry full power to the headstock.

24. BUILT-IN ELECTRICAL CONTROL CABINET is designed in accordance with standards set by the National Machine Tool Builders Association and the Automotive Industry.

PRATT & WHITNEY

THE PRATT & WHITNEY Model "C" Lathe is designed particularly to meet the demands of modern tool room practice. It is precision-built by master craftsmen and is heavy and strong to maintain that initial accuracy through a long, useful life. It will shave off a fine lace chip, or its powerful gear drive will pull a cut heavy enough to stall many larger machines.

The Model "C" Lathe is distinguished by its smooth, quiet operation, and by the convenience of its various controls. Men like to operate the Model "C" Lathe, and can do more and better work with it. When you install a Pratt & Whitney Model "C" Lathe you have dependable performance and lowered maintenance costs.

All Model "C" Lathes have precision lead screws and will do excellent thread cutting sufficiently accurate for most needs. For exceptional accuracy requirements we can furnish special lead screws selected according to the work to be done.

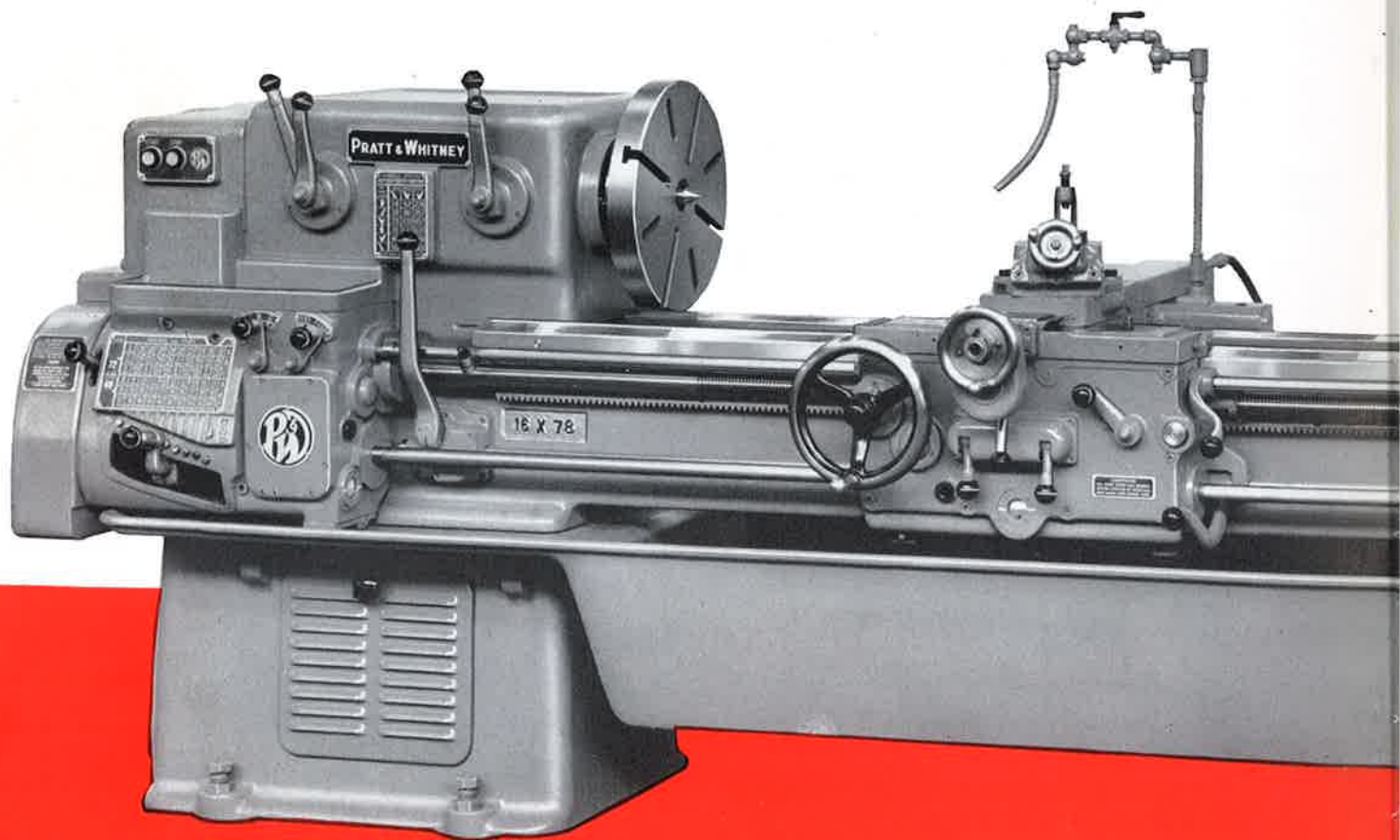

THE STANDARD BY WHICH

MODEL "C" LATHES

Metric Model "C" Lathes

Metric Model "C" Lathes are exactly the same as the English machines described in this book, except that graduations on the various dials are in the Metric system and a Metric lead screw with extra change gears is substituted. With this equipment the lathe will cut all standard Metric leads. When necessary a lathe with English screw can be equipped with translating gears English to Metric, or similarly a Metric lathe can have translating gears Metric to English.

Special Length Beds

In addition to the standard bed lengths listed below, Model "C" Lathes can be made to order in any bed length to suit individual needs. Bed lengths longer than standard are usually made in increments of two feet, giving maximum center distances of 102", 126", 150", etc. These longer beds require one or more center supporting legs for structural strength.

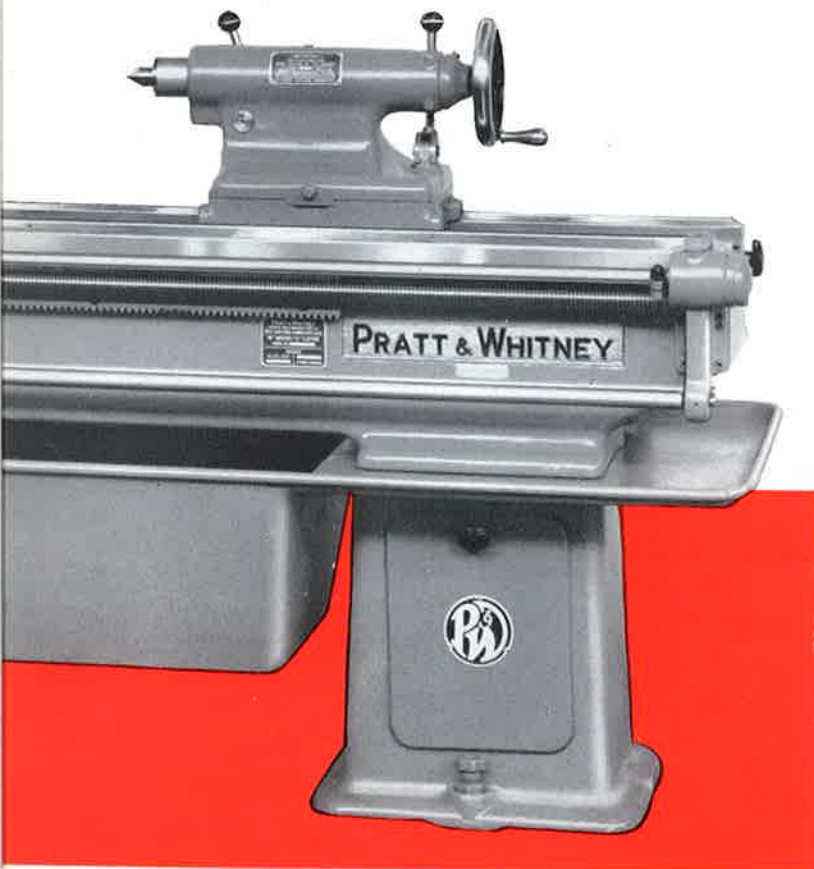

Standard Sizes

Size	Swing Over Bed	Maximum Center Distance on Standard Beds		
		30"	54"	—
12-INCH	14½"	30"	54"	—
16-INCH	18½"	30"	54"	78"

Complete specifications are given on page 18.

Illustration shows 16-inch lathe with 78-inch bed length

PRATT & WHITNEY

PRECISION IN EVERY DETAIL

No other lathe is built under more painstaking methods to assure its final accuracy. The operations shown here are typical of many we have developed to control the accuracy of assembly. That is why all Model "C" Lathe units can be assembled interchangeably, and is the basis of the remarkable reputation for precision these

lathes have in shops everywhere. How these lathes are put together is worth while seeing first hand. We will be glad to show you the entire process in our modern plant in West Hartford. You will be impressed with the care and craftsmanship in every detail, and will understand better the real significance of Pratt & Whitney precision.

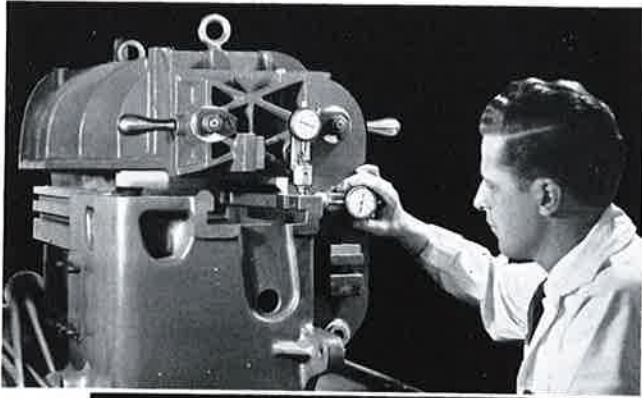

This fixture checks the accuracy of the ground bearing surfaces on the bed which locate the headstock and gear box. The inspector first sets his dial indicator on the correctly located pad on the fixture, and then swings it 90° into contact with the bed. These locating points are held to extremely close limits which assures accurate alignments.

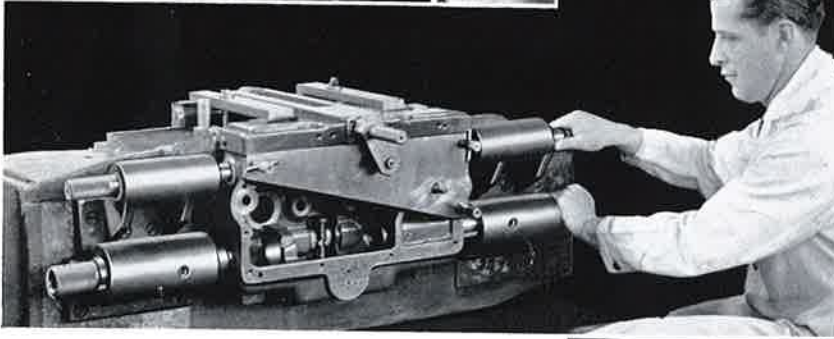

This precision fixture holds the carriage and apron castings in precise alignment while they are being pinned and fastened together. Every step in Model "C" Lathe manufacture is controlled by similar precision practice.

Before a hardened and ground bed may serve as the foundation for any Pratt & Whitney Lathe, it must pass a rigid inspection on all counts. Inspector at right tests carriage ways with a straightedge and a feeler strip precisely .0002" thick. Total end-to-end error may not exceed .0002" with straightedge in any one of a number of positions. Other tests include hardness, parallelism of carriage and tailstock ways, flatness, V formation, finish and dimensions.

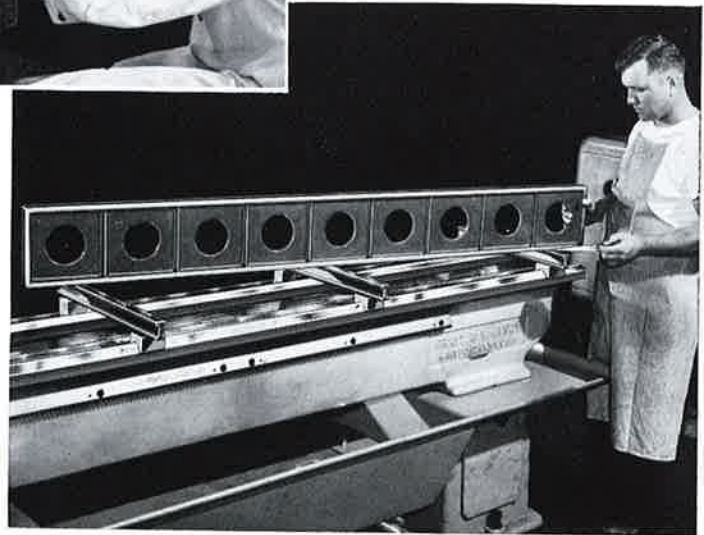

First Choice



for Accuracy

6 THE STANDARD BY WHICH

MODEL "C" LATHES

Bed Ways Are Flame Hardened and Ground

Pratt & Whitney hardened and finish-ground way surfaces are an integral part of the bed casting and have a hardness approaching that of hardened tool steel. Their great wear resisting quality is especially

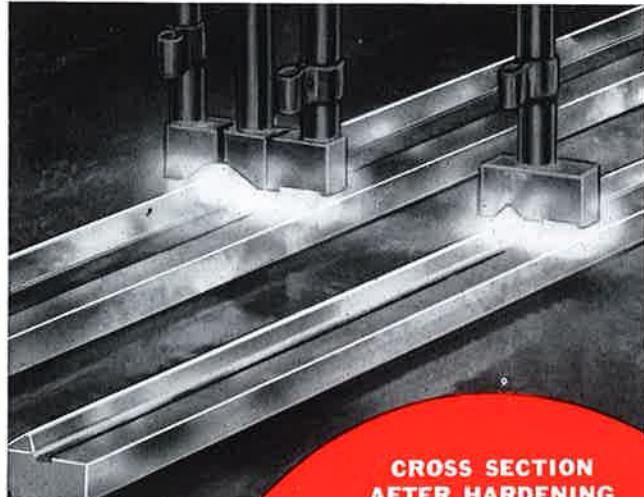

advantageous where work is abrasive or where carriage and tailstock movements are highly repetitive.

The bed castings are made from a tough, close-grained iron of special composition, carefully stabilized to eliminate any possibility of distortion. The way surfaces are flame hardened with equipment built to the specifications of Pratt & Whitney metallurgical engineers. Depth of case attained is approximately $\frac{1}{8}$ inch after grinding, and Scleroscope readings average 72 to 74.

Left: Flame hardening process, showing all but the ways of a bed casting submerged in water.

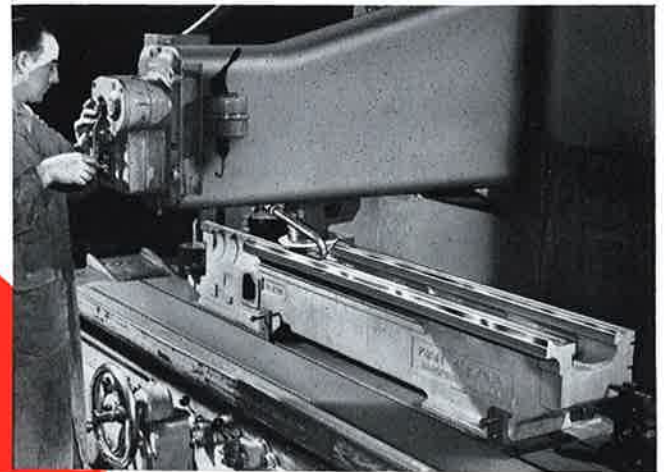

CROSS SECTION AFTER HARDENING

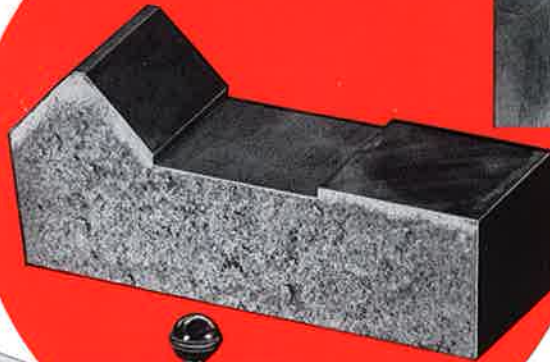

Finish grinding the front V-way of a Model "C" Lathe. All ways are accurately ground with the total end-to-end error not exceeding .0002".

Finishing is done by expert craftsmen on specially equipped horizontal grinders, with angle of V-ways and plane of flat ways carefully controlled to insure perfect bearing. Surfaces are smooth and accurate, and due to graphite flake content, have a microscopic porosity which retains a film of lubrication on the ways at all times.

Accuracy throughout the length and width of both carriage and tailstock ways will last indefinitely. This is because an exclusive method of balancing stresses during hardening makes the bed absolutely inert. Test castings flame hardened and ground by this method were checked regularly over a period of ten years and showed no sign of change.

Constant Speed Motor Drive

The driving motor of the Model "C" Lathe is mounted on a hinged platform inside the cabinet leg under the headstock. A multiple V-belt carries the full power of the motor to the constant speed drive pulley on the headstock. Push button control is used, with the push button located conveniently to the operator's left hand. A removable steel cover on the cabinet leg provides easy access to the motor. In this position it is thoroughly protected from dirt and chips, yet is well ventilated and fully accessible for oiling and servicing.

The rear of the headstock forms a "column" construction from top to bottom. This produces a very rigid support for the constant speed drive pulley and shaft with practically no overhang, and takes the pulley driving belt pull on a solid foundation.

Electrical Control Equipment

At the headstock end of the machine, above the motor, is a large compartment designed to house numerous combinations of starter, disconnect switch, overload relay, transformer, etc., in accordance with standards set by the National Machine Tool Builders Association and the Automotive Industry.

Quick Change Gear Box

A direct reading index plate mounted on the gear box permits rapidly setting and checking threads or feeds without recourse to tables or charts. The operator can see at a glance from the positions of his levers the feed or the thread for which his lathe is set.

GEARS	THREADS AND FEEDS																
1 .258	1 1/8 .252	1 1/4 .208	1 3/8 .192	1 1/2 .176	1 5/8 .168	1 3/4 .160	1 7/8 .152	1 3/4 .144	1 7/8 .136	A							
2 .125	2 1/4 .116	2 1/2 .104	2 3/4 .096	2 5/8 .088	3 .084	3 1/4 .080	3 1/2 .076	3 3/4 .072	3 5/8 .068	B							
4 .064	4 1/2 .058	5 .052	5 1/2 .048	5 3/4 .044	6 .042	6 1/2 .040	6 3/4 .038	7 .036	7 1/2 .034	C							
8 .032	9 .029	10 .026	11 .024	11 1/2 .022	12 .021	13 .020	13 1/2 .019	14 .018	15 .017	A							
16 .0160	18 .0144	20 .0130	22 .0118	23 .0112	24 .0108	26 .0100	27 .0098	28 .0092	30 .0086	B							
32 .008	36 .0072	40 .0065	44 .0059	46 .0056	48 .0054	52 .0050	54 .0048	56 .0046	60 .0045	C							

The quick change lever controls a rocker gear which meshes with a pinion that in turn takes its drive from the gear train. This shift operates smoothly and silently, and is the easiest known hand shift on a lathe quick change gear box.

At the left end of the gear box is a hinged guard which covers a quadrant and change gear arrangement. This is for change gears for special threads, or for translating gears when metric threads are to be cut.

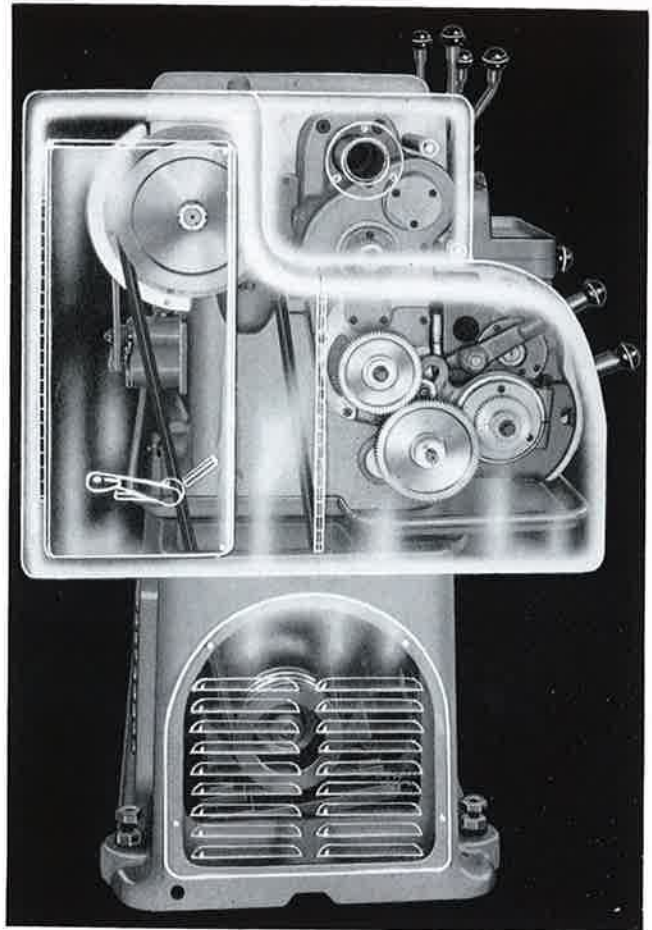

Power is transmitted to the quick change gear box through a double-end clutch to provide forward and reverse movement of the carriage. The clutches are the positive single-tooth type and incorporate a synchronized starting device which allows smooth engagement to forward or reverse at high speeds.

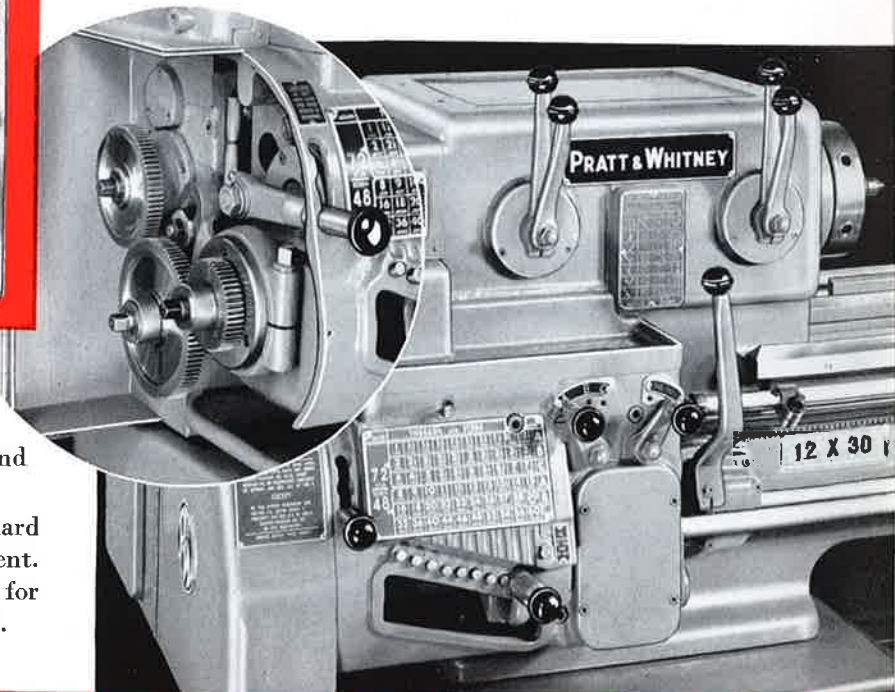

MODEL "C" LATHES

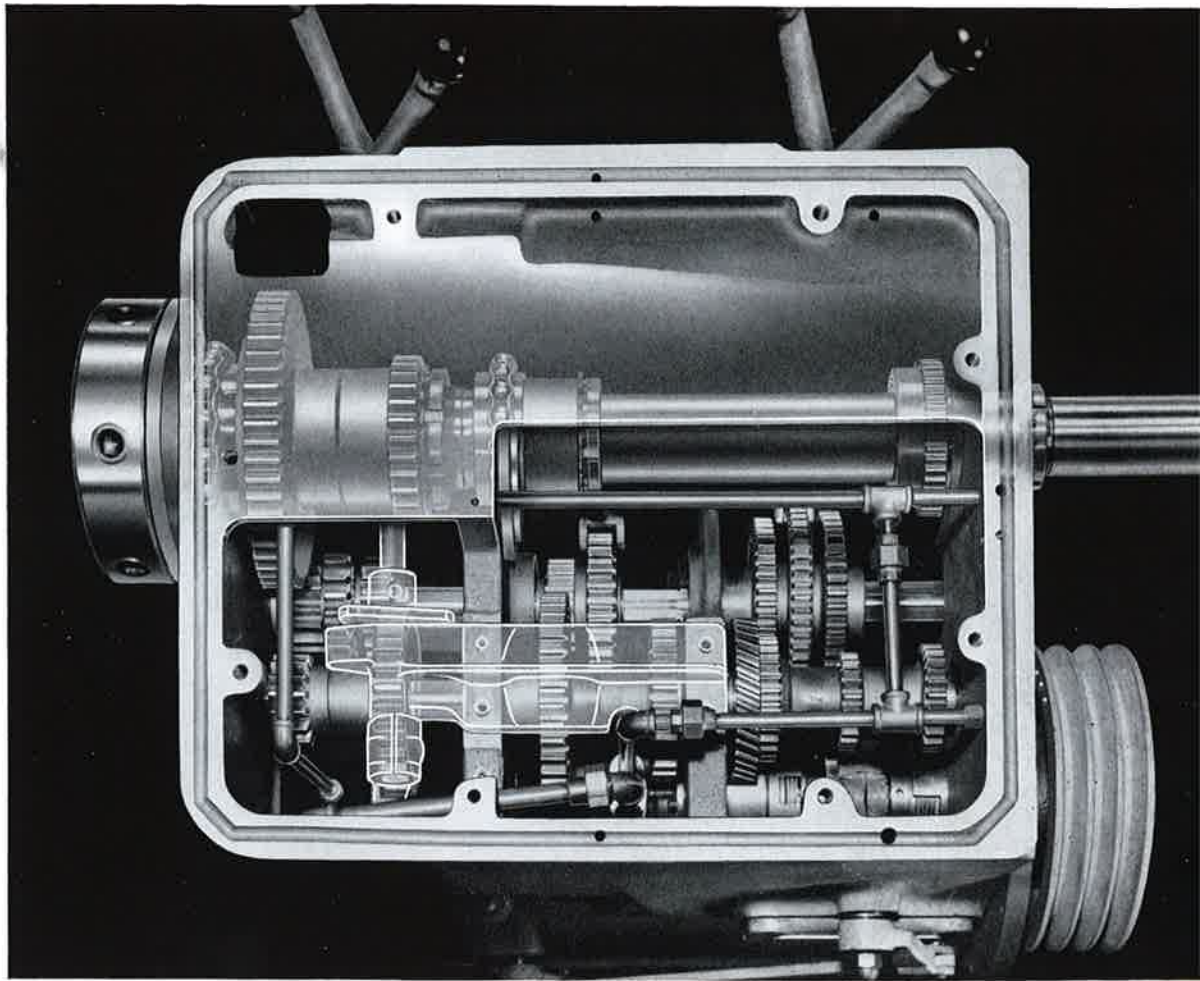

Main Drive Clutch

The main drive clutch is mounted inside the headstock on the same shaft as the constant speed drive pulley. It is a multi-disc type clutch, operated either from the headstock or the apron. It has three operating positions, power on, power off (neutral), and a third position which applies a friction brake for stopping the spindle quickly. A plate on the back of the headstock provides easy access for simple clutch adjustments.

Headstock Gearing

Power from the main drive clutch is transmitted to the headstock gear train through a pair of helical gears. All other headstock gears are spur gears. Four gear shift levers on the front of the headstock control this gearing, so that 18 spindle speeds are available in smooth, geometrical progression. Headstock gears are made of alloy steel and are hardened and ground. They are finished on Pratt & Whitney gear grinders which eliminate hardening distortions and leave a smooth finish which is accurate both for tooth profile and tooth spacing within a few ten-thousandths. The operating perfection of these gears is what makes possible the

well known smoothness and quietness of a Model "C" Lathe, without any chatter or gear marks on the work.

In the phantom view above the entire gear train is shown, looking from the rear of the headstock.

LUBRICATION

A rain of clean, cooled, filtered oil pours over every headstock gear while the lathe is in motion. Underneath the headstock in the bed is a reservoir containing a large quantity of lubricating oil spread out over a considerable area to keep it cool. The oil is pumped through filters and up through a system of piping to provide a continuous stream of clean oil over each gear. Thus lubrication is positive and complete. Means are also provided for carrying this filtered oil into all ball bearings supporting the various shafts, as well as to the three bearings which carry the spindle. The entire headstock is tightly enclosed, and there is no chance for dirt or grit to reach this oil. It is a simple matter to drain the bed reservoir and refill it at any time according to regular servicing practice. An oil level gage is provided for filling, and a sight window shows that the pump is operating properly.

PRATT & WHITNEY

Spindle

The spindle of a Model "C" Lathe is a beautiful piece of precision work. It is hollow to accommodate a draw-back, and is hardened and ground. It is mounted at three points. The two front bearings, spaced closely to provide rigid front support, are preloaded super-precision ball bearings. The rear end bearing is of the anti-friction needle type.

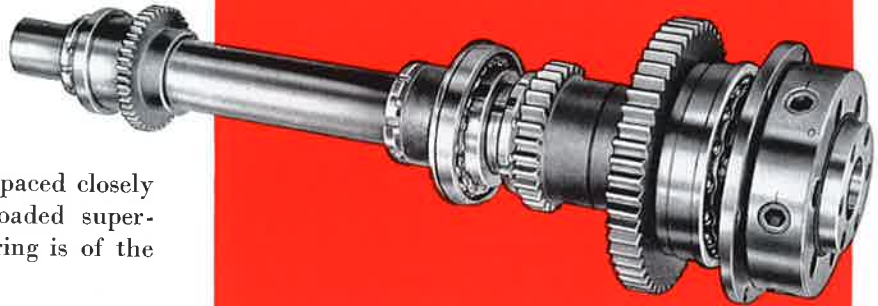

Spindle Speeds in Smooth, Geometrical Progression

This is a correctly plotted curve of the eighteen spindle speeds of a Model "C" Lathe as shown on the index plate. Here, in graphical form, is the reason why you always have available the right spindle speed for a job. These eighteen speeds are arranged in geometrical progression, with no large gaps. This means that the next lower or higher speed is not a big jump away, but near enough so you can turn every job at full cutting efficiency.

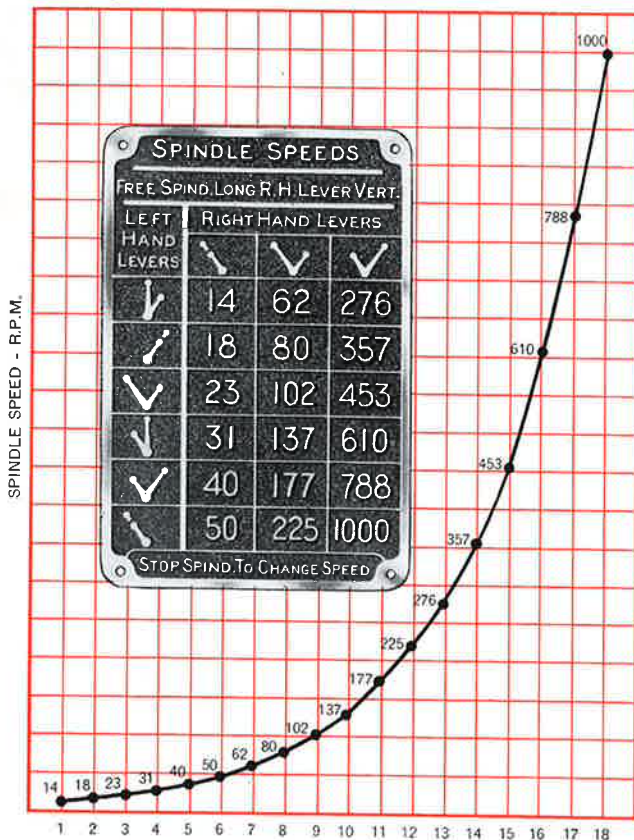

Lathe the greatest variation from the theoretical speed is only $1\frac{1}{4}\%$, a real engineering accomplishment!

It also is possible on any Model "C" Lathe, by a simple change (to order only) at our factory, to increase all spindle speeds 50%, thus making the spindle speed range from 21 to 1500 rpm.

The Cam-lock Spindle Nose

Adopted by the American Standards Association as the spindle nose which provides the most rigid and accurate means of holding chucks, face plates and fixtures to the spindle. The pilot taper and flange face

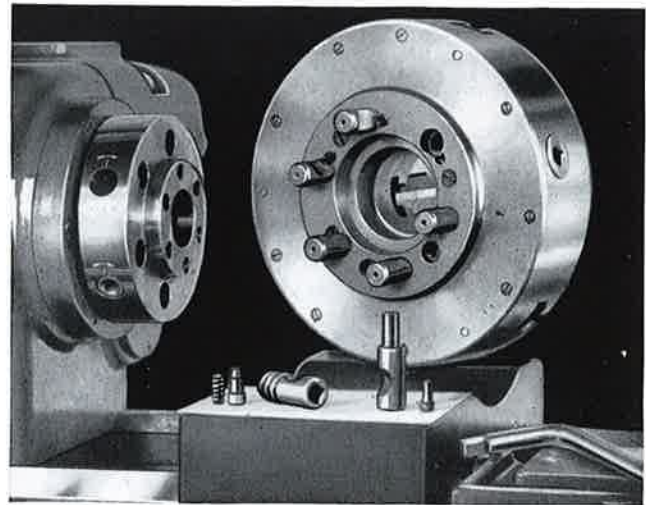

First Choice



... the Standard by which all

It is easy to figure out theoretical speeds in geometrical progression, the acknowledged ideal arrangement, but it is quite different to find reasonable gearing to actually produce these speeds. In the Model "C"

MODEL "C" LATHES

insure permanent accuracy in holding the chuck or face plate central and square. There are no threads to be damaged or to catch dirt or chips, the holding means being a series of cam-locking studs on the back of the chuck or plate which fit into radial holes in the spindle flange. There is no possibility of a chuck being thrown off during high-speed operation or when the spindle is stopped suddenly.

The Cam-Lock nose also provides the most convenience and safety in mounting and removing chucks



and face plates. There is no need to lock gears and pound a chuck loose, because it cannot "freeze" on.

Still one more great advantage of the Cam-Lock nose is the fact it is the "American Standard" for Toolroom Lathes, Engine Lathes, Turret Lathes and Automatic Lathes. This insures accurate interchangeability of chucks and fixtures on all lathes equipped with the Cam-Lock Spindle Nose without requiring an adapter plate.

Lead Screw and Feed Rod

In the right end of the quick change gear box is a separate compartment containing the drive to the lead screw and feed rod. A convenient lever engages either the one drive or the other, but never both. By having the lead screw and feed rod separate, all wear on the former is eliminated except during actual thread cutting. The lead screw does not even revolve except when actually in use, and wear that might impair its accuracy is reduced to a minimum. All ordinary cutting duty is taken by the splined feed rod. In addition the precision lead screw is located behind the other rods so its threads are protected from accidentally dropped tools.

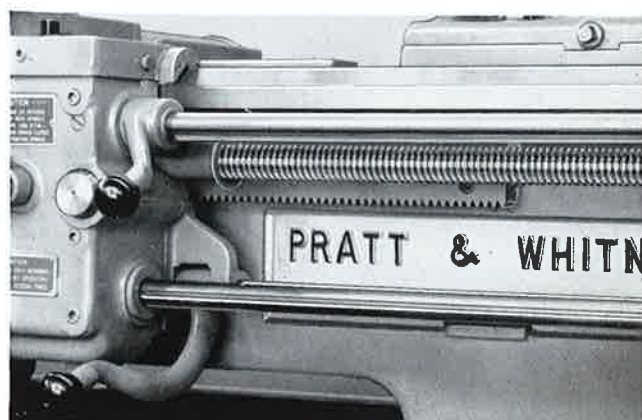

Separate Lead Screw and Feed Rod preserve the original accuracy of the machine. The lead screw is used only during actual thread cutting, and in ordinary turning operations the carriage is moved entirely by the splined feed rod. Wear that might impair precision is reduced to a minimum.

LEAD SCREW SPECIALLY CUT

Model "C" Lathe lead screws are cut on special machines developed particularly for the purpose at our plant. Our experience in precision thread cutting covers four score years, and during that time we have developed a method of producing threads with constantly accurate results. Pratt & Whitney lead screws are well known for their accuracy.

A standard Model "C" Lathe lead screw is of an order of accuracy sufficient for tool room precision work. We can supply ultra-precision lead screws to order for special requirements. Every lead screw is checked and a permanent record kept of its accuracy characteristics.

End thrust on a Model "C" Lathe lead screw is taken on super-precision ball thrust bearings made for this particular purpose. These bearings are the result of special research. They produce smooth, precise lead screw operation, and eliminate "drunken" threads.

for Accuracy

all fine lathes are judged...

Cross Slide Positive Stop

The cross slide screw is of large diameter and is hardened and ground with a left hand, single Acme thread. It is supported in a duplex, radial ball thrust bearing. This combination gives an easy hand action or "feel" to the cross slide. The large micrometer dials are graduated to give work diameter reductions in thousandths of an inch. The cross slide positive stop for thread cutting is very easy to use and is positive in both directions.

The carriage is equipped with special wipers which efficiently prevent dirt and grit from getting under the scraped carriage ways. A suitable binder is provided to lock the carriage in any desired position along the

bed. The carriage is gibbed, and runs on one Vee and one flat way to insure proper aligning.

A thread chasing dial is built into the right side of the apron, and is used for easily picking up a thread. This dial reverses with the lead screw, and carries gradua-

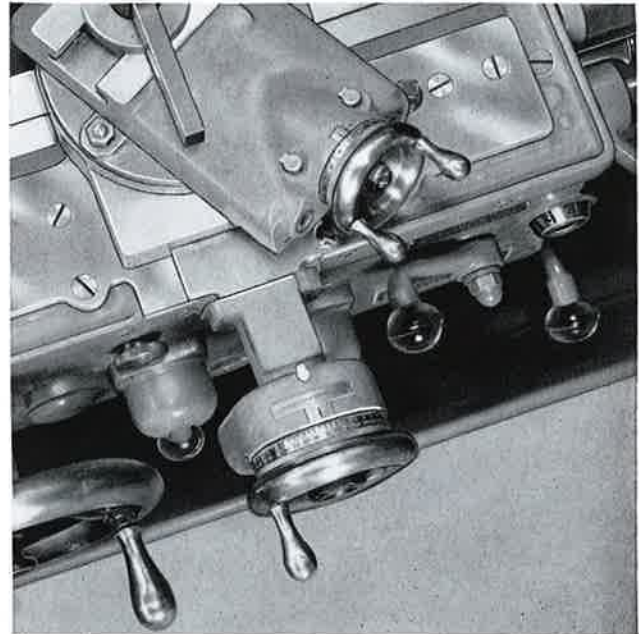
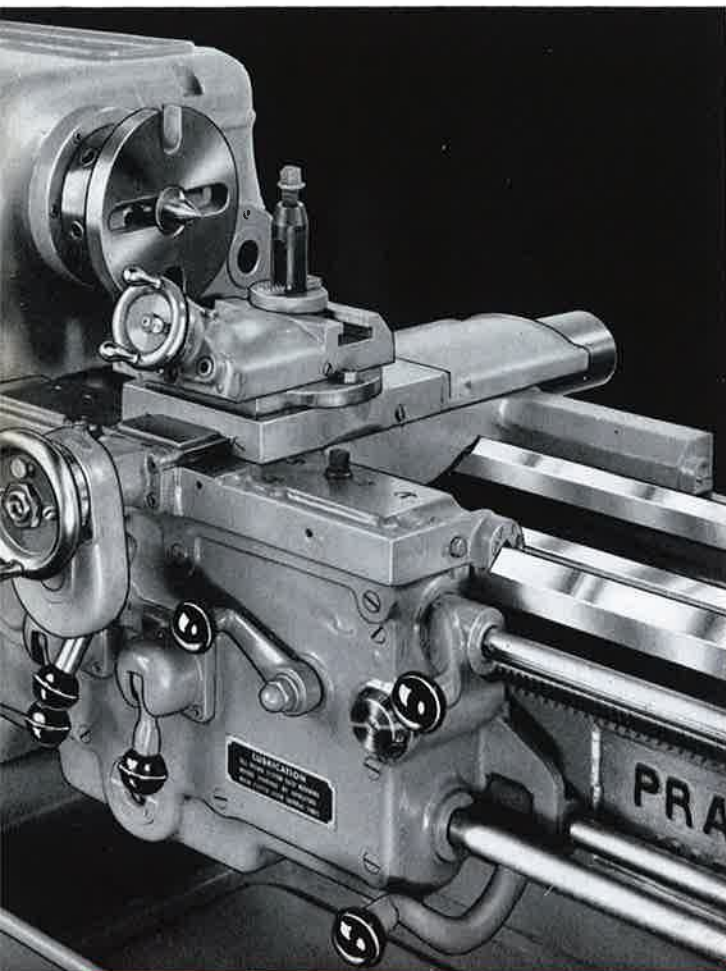

Large Direct-Reading Dials contribute to speed, accuracy and convenience in operation. The easy-to-read graduations give work diameter reductions in thousandths of an inch on the cross slide and on the compound rest.

tions giving the proper points to engage the lead screw nut. The thread chasing dial also may be used when cutting certain multiple threads, without the need of a special indexing device.

The compound rest is graduated for accurate angle setting, and is equipped with a large screw and dial graduated to give work diameter reductions in thousandths of an inch. The compound rest handwheel is elevated at an angle to provide complete knuckle clearance. The tool slide is a steel drop forging, which eliminates breaking out the T-slot under heavy pressure as so often happens when cast iron is used.

The carriage is equipped at both ends of both ways with these special wipers that keep out all dirt and grit. A piece of spring bronze backed up by a heavy piece of felt cleans the bearing surfaces thoroughly as the carriage moves. Oil from inside the carriage is brought to the felt for positive automatic lubrication.

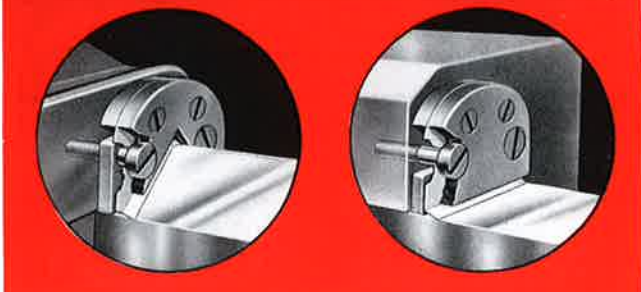

MODEL "C" LATHES

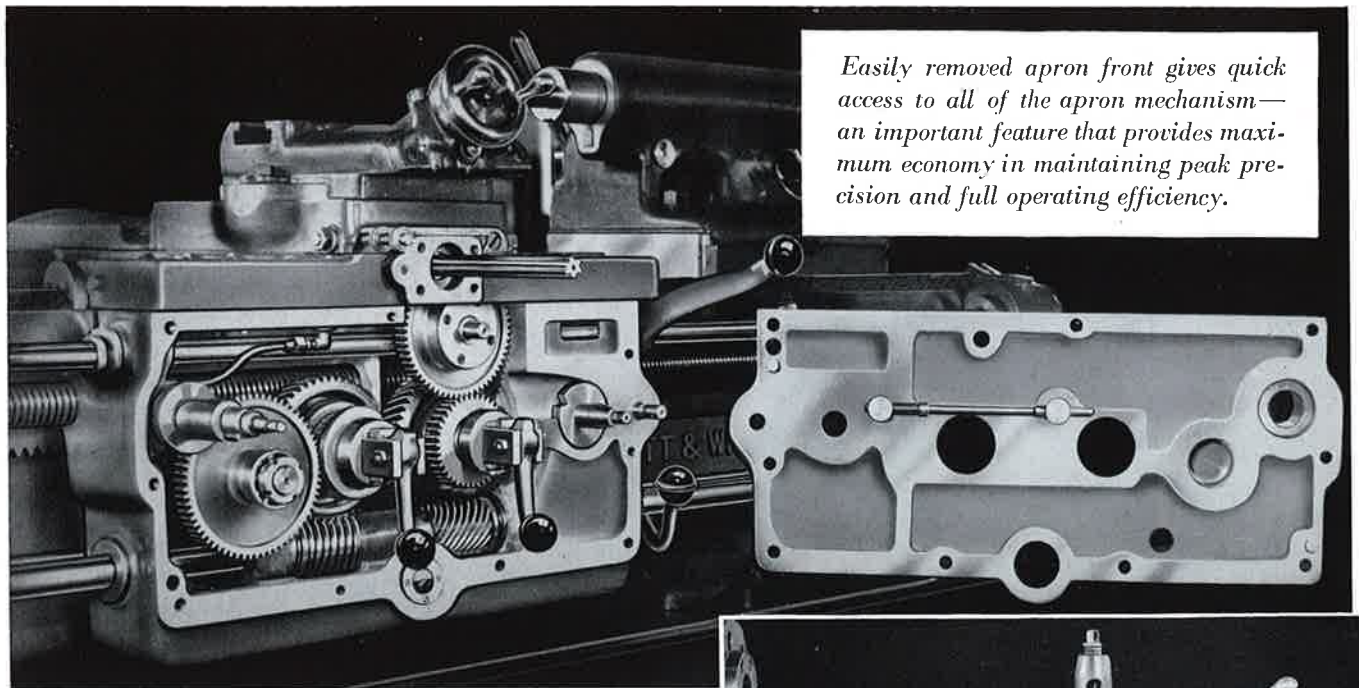

Easily removed apron front gives quick access to all of the apron mechanism—an important feature that provides maximum economy in maintaining peak precision and full operating efficiency.

Removable Apron Front

The Model "C" Lathe apron represents a radical departure from previous lathe practice in that the front is removable. It no longer is necessary to remove the entire apron together with the lead screw, feed rod, etc., to make apron adjustments. This is of decided importance in maintaining a precision lathe at its fullest efficiency with the least trouble.

The interior of the apron is heavily walled to provide rigid and ample support for the lead screw and feed rod, and for the various worms and gears. All spur gears and worms in the apron are mounted on ball bearings. There are no bevel gears in the apron. An interlocking device prevents the lead screw half nuts from being engaged unless the longitudinal traverse friction is fully disengaged or vice versa. The feed clutches in the apron are not friction operated, but engage positively. The main members have fine teeth which are held in positive contact by a cam which is part of the clutch lever. A friction safety device is incorporated in the cross feed screw drive to guard against excessive feed and faulty operation.

Tailstock Is Extra Heavy

The tailstock is mounted on separate hardened and ground bed ways. Its main casting is very heavy and designed for extreme rigidity. Spring-loaded ball bearings support nearly all its weight so that little effort is required to move it into position. The large spindle is accurately fitted and provided with a tang slot to prevent drills and chucks from twisting. An accurate scale on the top surface of the spindle is graduated in sixteenths for drilling or boring to depth. The spindle

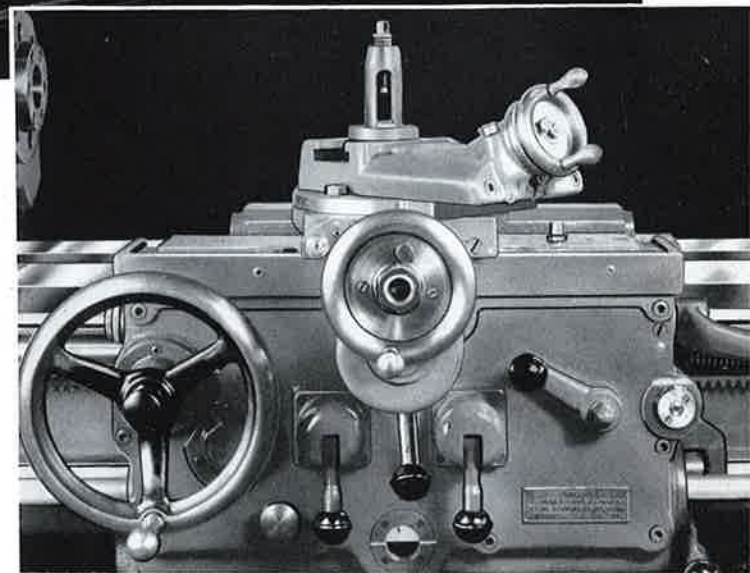

binder is an exclusive wedge-type clamp which binds the spindle from the bottom over a considerable part of its length rather than at one point. Two clamps, operated by a single lever, lock the tailstock solidly in position for the heaviest of work. Spring bronze wipers are provided to clean ways and prevent any chance of dirt getting underneath the base.

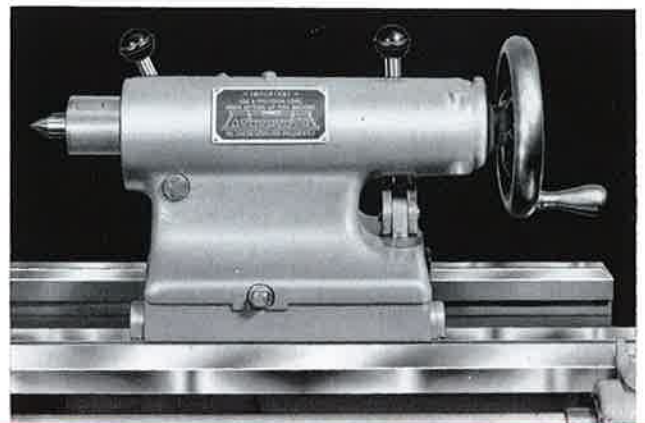

MODEL "C" LATHES

ADDITIONAL EQUIPMENT

Radial, Spiral and Side Relieving Attachments

The relieving attachments designed and developed by Pratt & Whitney are the result of years of careful study. These attachments for radial, spiral and side relieving now provide a simple means of relieving all sorts of straight or spiral fluted work at a minimum cost. Mounted at the rear of the machine, these attachments do not interfere with any of the usual lathe functions.

They can be disengaged easily and quickly when not required.

A gear box bolted to the rear of the lathe headstock brings the power to the telescoped drive shaft of the radial relieving attachment.

The relieving motion is obtained by means of a cam and roller, with a spring to return the cross slide. This mechanism is mounted on the rear of the cross slide and is supported by the taper attachment. A friction device

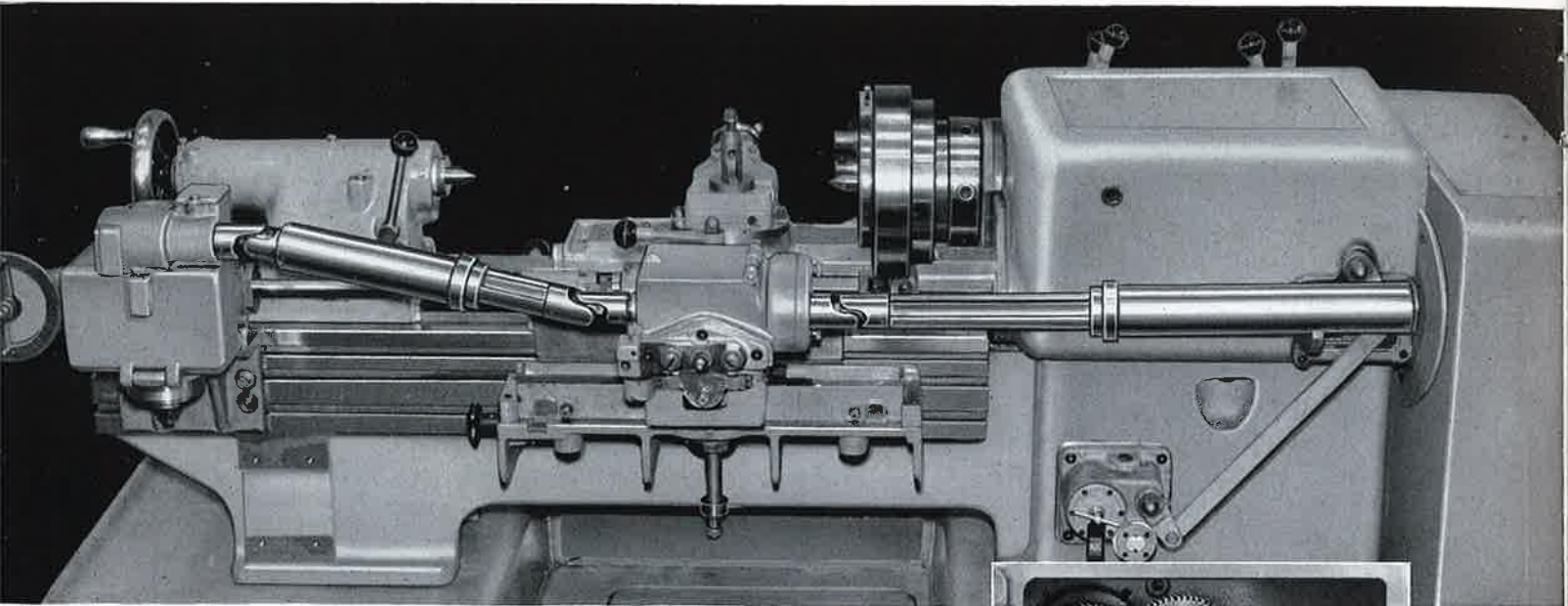

The relieving attachment gear box is shown at the extreme right, the radial attachment is in the center attached to the carriage and taper attachment, and the side attachment is at the left. The telescoped drive shafts transmit power, while cams control the motion. The insert shows the gear box with cover open showing the change gears. Every Model "C" Lathe is drilled and tapped to receive relieving attachments at any time.

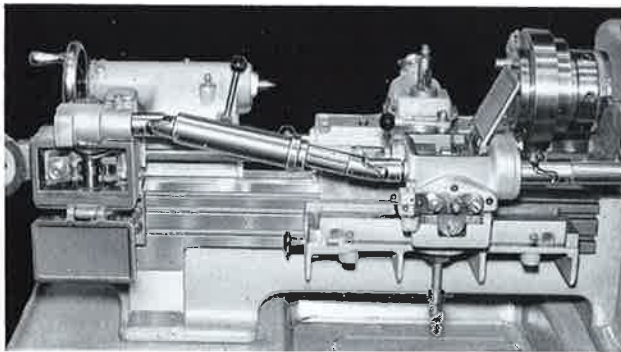
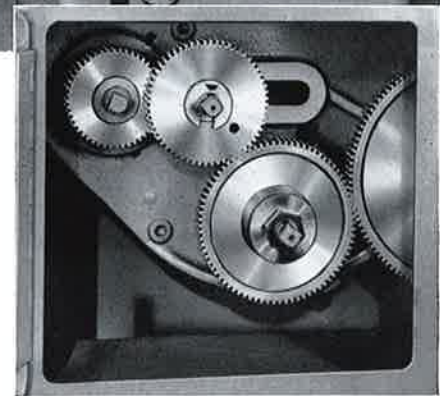

Detail of the radial and side relieving attachments with covers raised to show the cams. Levers throw the cam followers in and out of engagement.

on the end of the drive shaft insures the smooth operation needed for relieving work. This attachment produces a simple movement of the cross slide at right angles to the bed. A lever is provided for throwing the attachment out of action when desired.

For spiral relieving, the equipment consists of the radial relieving equipment plus certain gears to give the complete range of spirals.

The side relieving attachment may be used separately or in conjunction with the radial relieving attachment.

This side relieving attachment was developed to give the cutting tool a longitudinal movement to produce side and/or end relief. The attachment is clamped to the rear of the bed as illustrated. It is connected to the lathe carriage by means of a rod with an adjusting thread which passes through a bracket bolted to the rear of the carriage. This rod transfers the cam motion to the carriage, moving it back and forth along the ways.

The sidewise motion is produced by a camshaft and cam, and the drive is through a telescoped drive shaft. The side relieving attachment takes its power from the radial relieving attachment drive if the latter attachment is in use, or directly from the gear box through a long shaft if the side relieving attachment is being used alone.

These attachments are available either singly or in combination as desired. When used in combination the Speed Reducer must be used.

It is very important for good results that relieving operations be carried out at much slower spindle speeds than ordinary lathe work, in order that the reciprocating parts of the relieving attachments have time to function properly. That is why all Pratt & Whitney Relieving Attachments have been designed to be used in conjunction with the Speed Reducer shown at right.

The Pratt & Whitney Model "C" Lathe equipped with relieving attachments and the speed reducer will handle most tool room relieving operations. This equipment is a means of solving many difficult problems which might otherwise require special machinery and fixtures.

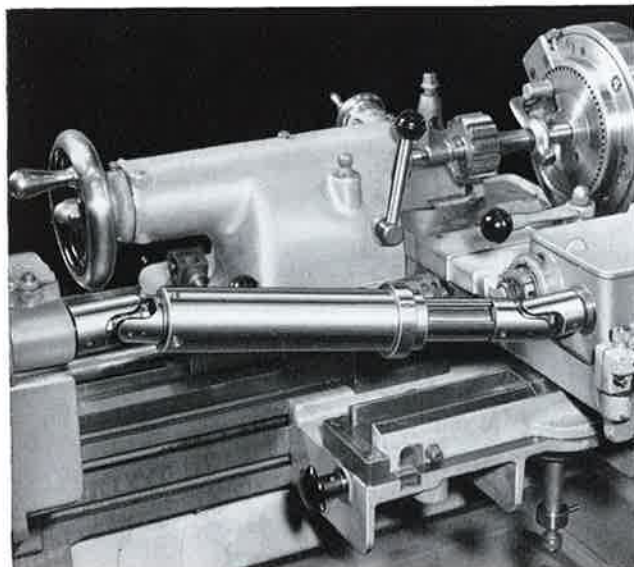

Spiral relieving on a special hob having twelve flutes.

Speed Reducer

The Speed Reducer provides a 6 to 1 spindle speed reduction, making possible speeds as low as two revolutions per minute. It mounts on the Cam-lock spindle nose, and as it uses the regular headstock center, mounted in the spindle nose, it does not impair the lathe accuracy at all. It also acts as an indexing face plate with the necessary notches for multiple starts. Due to the 6 to 1 reduction it is possible to cut double, triple and sextuple starts directly without using the notches. This is done by engaging the lead screw nut as the correct number on the face plate passes the index mark.

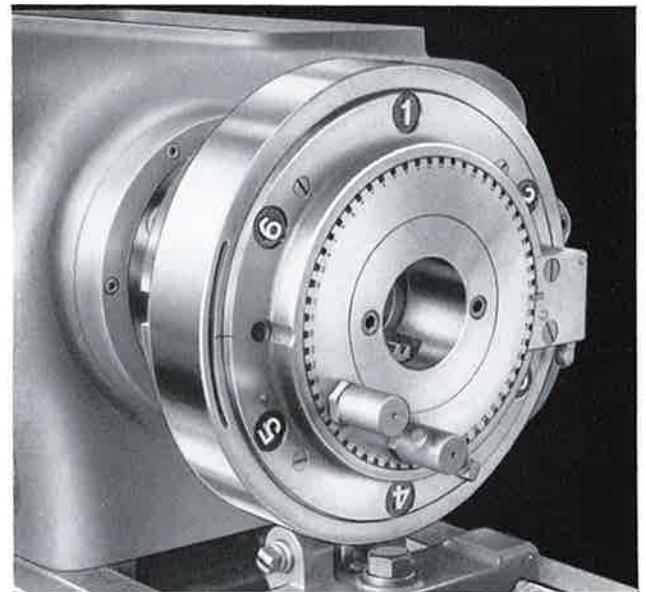

The Speed Reducer is designed particularly for use in relieving operations, and we recommend that it always be used with the relieving attachments. It also is useful for all kinds of work requiring slow spindle rotation, such as precision thread chasing, and cutting extremely long leads.



First Choice for Accuracy

MODEL "C" LATHES

Ball Bearing Taper Attachment

This attachment permits smooth, accurate tapers to be turned or bored even when taking exceptionally heavy cuts. Preloaded ball bearings eliminate any chance of lost motion or backlash. All bearing surfaces are hardened and precision ground for long accurate wear life.

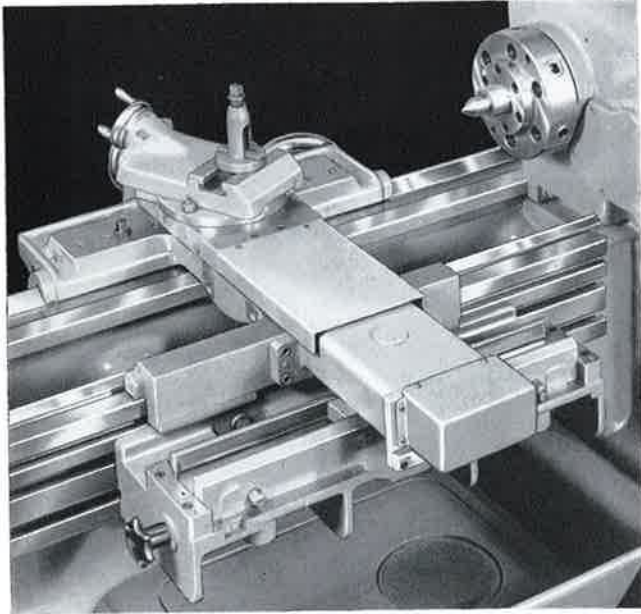

The taper bar bracket bolts securely to the rear of the bed and can be easily set from the front of the lathe. Easy-reading graduations, in both degrees and inches per foot, permit accurate settings to be made up to 20° included angle (4" taper per foot), and 15" in length on 12" Lathes or 18" length on 16" Lathes.



Multiple Indexing Face Plate

This face plate is recommended for cutting multiple threads, or wherever accurate indexing is essential. Sixty divisions make it possible to cut almost any multiple thread quickly and with great indexing accuracy. This attachment is not needed when the Speed Reducer is available.



Coolant Pump and Piping

All Model "C" Lathes are drilled and tapped for mounting a pump unit as shown below. A separate motor makes this unit independent of the lathe power. Control switch is located at headstock end of machine. This attachment includes complete piping. The lathe pan acts as the reservoir.

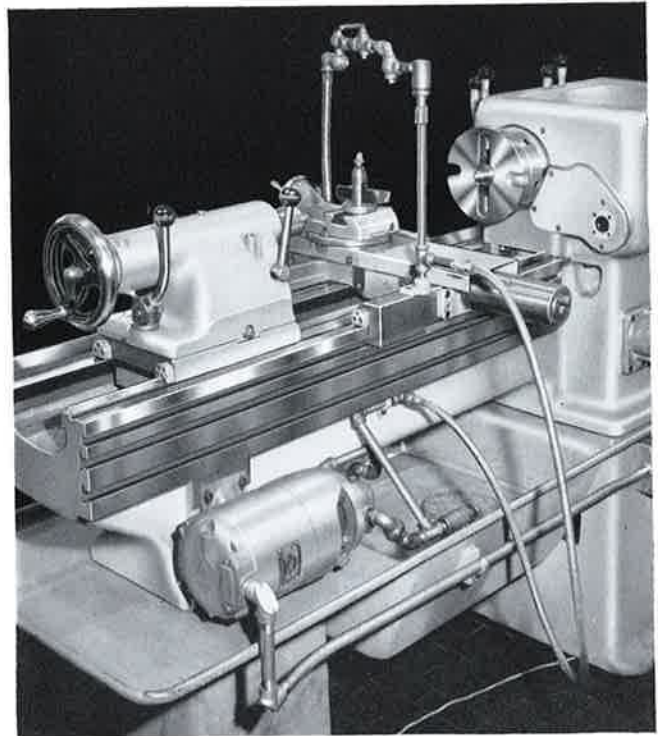

Micrometer Carriage Stop

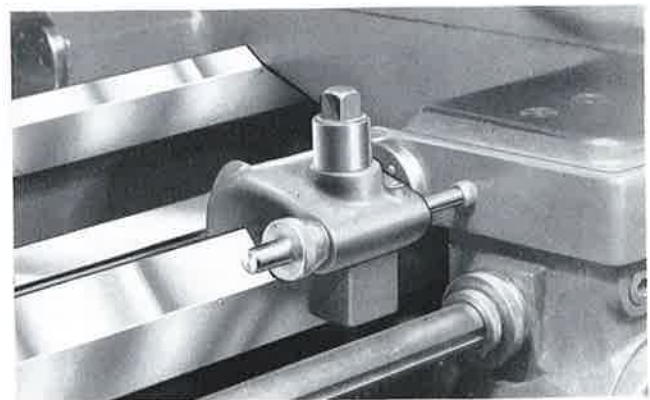

The micrometer carriage stop can be changed over for use on either side of the lathe carriage. It is graduated in thousandths of an inch.

Carriage Spacing Attachment

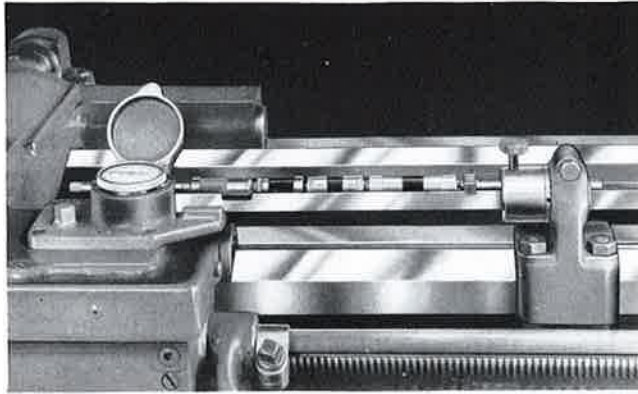

For greater accuracy in turning exact lengths, facing off, etc., we recommend this attachment. An indicator gage, an inside micrometer and end measures give a direct reading without depending on "feel" as in the case of ordinary stops. This spacing attachment has a 7" range of adjustment without resetting.

Collets and Collet Rack

Pratt & Whitney Collets are made of tool steel and are hardened and ground to close limits to insure a long, accurate life. They can be furnished in sets or singly in English or Metric sizes. A list of sizes is given on page 19.

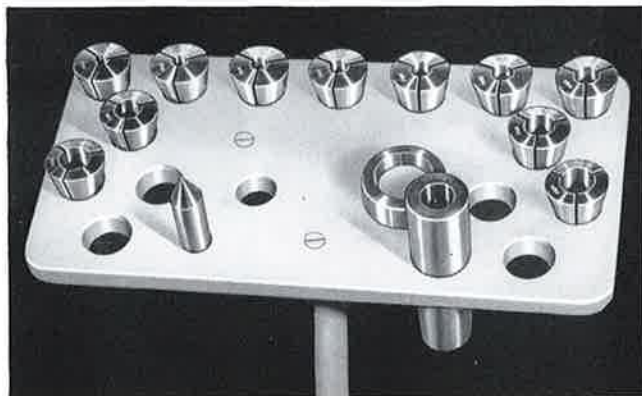

The Collet Draw-Back Attachment is necessary to hold collets in the spindle nose. This attachment consists of a draw-in sleeve and a collet closer.

The Collet Rack, shown above, mounts on the rear of the bed, and provides a convenient spot to store collets.

Follow Rest

Designed to give maximum rigidity for heavy cuts on long work. The follow rest has a four-bearing support on the carriage bridge. Round jaws, adjustable for capacity, with wedge-shaped tips are furnished.



Regular Steady Rest

This is part of the regular equipment supplied with every lathe, but is available separately when several are needed on long work. It is very easily adjusted, and very rigid.

Oversize Steady Rest

It is exactly the same except for size as the standard steady rest which is part of the regular equipment. It clamps solidly to the ways of the lathe bed, is very rigid, and can be adjusted quickly.



Expansion Arbors and Bushings



Step Chucks and Closers



PRATT & WHITNEY

SPECIFICATIONS

REGULAR EQUIPMENT

Range:

	12-Inch		16-Inch	
Center distance, maximum	30"	54"	30"	78"
Swing over bed	14½"		18½"	
Swing over carriage	8"		10"	
Height from spindle center to floor	43"		43"	
Center of spindle to top of bed	7"		8⅞"	
Center of bed V to center of flat	11"		14½"	
Steady rest capacity (standard)	4½"		6"	
Tool post takes tool	½"x1"		⅝"x1¼"	

Headstock Spindle

Special alloy steel, hardened and ground; mounted on two pre-loaded super-precision ball bearings at the front, and on a quill roller bearing at the rear end.

Hole through spindle	1½"	1⅞"
Taper hole in spindle (American Standard)	No. 5 **	No. 200
Taper hole in center adapter (American Standard)	No. 3 **	No. 4 **
Cam-lock Spindle Nose, Type D-1	6"	6"
Collet capacity, draw-back type, maximum	1"	1¼"

Tailstock Spindle

Diameter	2¼"	2½"
Maximum travel	5½"	7"
Taper hole (American Standard)	No. 3 **	No. 4 **
Length of spindle graduation, by 16ths	5"	6"

Spindle Speeds

*18 spindle speeds in geometrical progression, rpm	14 to 1000	14 to 1000
Number of belts in multiple V-belt drive	3	4

Feeds

Feed changes (60) per rev. of spindle, carriage longitudinal	.0025" to .152"	.0043" to .256"
Feed changes (60) per rev. of spindle, carriage cross	.0025" to .152"	.0043" to .256"
Micrometer dials graduated in half-thousandths		

Threading

Thread changes (60), threads per inch	1 to 60	1 to 60
Lead screw, R.H. single Acme, English	4 PI	4 PI
Lead screw, R.H. single Acme, Metric	6 m/m	6 m/m

Motor Recommended

1800 rpm, constant speed, ball bearing, either ac or dc	3 hp	7½ hp
---	------	-------

Floor Space

	12x30	12x54	16x30	16x54	16x78
Length (with gear guard cover closed)	94"	118"	104¼"	128¼"	152¼"
Length (with gear guard cover open)	106¼"	130¼"	120¼"	144¼"	168¼"
Width	36"	36"	43"	43"	43"

Weights

Machine, regular equipment, approximate pounds	2600	2975	4200	4650	5100
Crating material, domestic, approximate pounds	640	750	650	850	1050
Boxing material, foreign, approximate pounds	775	950	925	1075	1225
Box, approximate cu.ft.	150	185	175	225	280

*NOTE: By means of a change, which must be made at our factory, all spindle speeds can be increased 50%, making the speed range from 21 to 1500 rpm. This is done to order only.

** Same as Morse Taper.

Regular Equipment

The lathe is regularly furnished with geared head, motor drive arrangement with motor base, motor pulley, multiple V-belts, belt guard, conduit and wiring, built-in push button station, attaching and testing electrical equipment, but WITHOUT motor and starter; lead screw reverse mechanism with automatic stop in both directions of carriage travel, automatic

lubrication for all main units; all shafts including main spindles mounted on anti-friction bearings, main spindle on preloaded bearings; main clutch and spindle brake multiple disc type running in oil; Cam-lock Spindle Nose; compound rest with drop-forged steel tool slide; cross slide positive stop; round tool post; steady rest; oil and chip pan; centers; large and small face plates; knock-out rod; set of wrenches.

SPECIFICATIONS

ADDITIONAL EQUIPMENT

Arbors and Bushings

No. 1 Expansion arbor — 4 bushings $\frac{3}{4}$ ", $1\frac{1}{16}$ ", $\frac{7}{8}$ ", $1\frac{5}{16}$ ";
5 bushings (metric) 19, 20, 22, 24, 26 m/m.
No. 2 Expansion arbor — 8 bushings 1" to $1\frac{1}{16}$ " by 16ths;
6 bushings (metric) 28, 30, 32, 34, 36, 38 m/m.
No. 3 Expansion arbor — 5 bushings $1\frac{1}{2}$ " to 2" by 8ths;
6 bushings (metric) 40, 42, 44, 46, 48, 50 m/m.
*Draw-in sleeve (same as furnished with collet attachment).

Carriage Spacing Attachment

For greater accuracy in turning exact lengths, facing shoulders, spacing grooves in shafts, etc.

Centers

In addition to the headstock and tailstock centers furnished as regular equipment with each machine; high speed steel, hardened.

Collet Chucks

Cushman or Sjogren — Fits the Cam-lock Spindle Nose; collet capacity $\frac{1}{8}$ " — $1\frac{3}{4}$ ".
Collets for collet chuck, fractional sizes and metric.
Jacobs — Fits the Cam-lock Spindle Nose; collet capacity $\frac{1}{16}$ " — $1\frac{3}{8}$ ".
Collets for Jacobs chuck, set of 11.

Collets

Set No. 1, English, 15 collets, $\frac{3}{8}$ " to $1\frac{1}{4}$ " by 16ths, (16" lathes only).
Set No. 2, Metric, 15 collets, 8, 9, 10, 11, 12, 14, 16, 18, 20, 22, 24, 26, 28, 30, 32 m/m (16" lathes only).
Set No. 3, English, 9 Style A collets, $\frac{3}{8}$ " to $\frac{7}{8}$ " by 16ths (see Note below).
Set No. 4, Metric, 9 Style A collets, 8, 9, 10, 12, 14, 16, 18, 20, 22 m/m (see Note below).
Set No. 5, English, 11 Style B collets, $\frac{3}{8}$ " to 1" by 16ths.
Set No. 6, Metric, 11 Style B collets, 8, 9, 10, 11, 12, 14, 16, 18, 20, 22, 24 m/m (see Note below).

NOTE: Style A collets are same as used on 13" and 12" Model "B" Lathes and 12" Model "C" Lathes up to serial number 175, inclusive. 12" Model "C" Lathes with higher serial numbers can take Style A collets if equipped with a Style A collet draw-back attachment. Style B collets, maximum size 1", can be used only on 12" Model "C" Lathes, serial number 176 and higher, and the lathe must be equipped with a Style B Collet Draw-back Attachment.

Special size collets.
Square and hexagon collets.

Collet Draw-back Attachment

Consists of a *draw-in sleeve and a collet closer. Either Style A or Style B attachments can be furnished for 12" lathes. Unless otherwise specified Style B will be furnished.

Collet Rack

For collets, collet closer, drill chuck and centers.

Drill Chuck

Fits tailstock spindle; capacity 0 to $\frac{1}{2}$ ".

Metric Equipment

A 6 m/m lead screw and 8 change gears are furnished.

Micrometer Carriage Stop

For accurately governing longitudinal carriage movement.

Multiple Indexing Face Plate

For cutting multiple start threads; mounts on Cam-lock Spindle Nose; a 60 notch index plate is usually furnished, but special plates to suit requirements can be furnished.

Pump and Piping

For cutting oils and compounds; self-contained motor driven unit.

Relieving Attachments

RADIAL RELIEVING: Furnished with cams and set of change gears, giving all regular changes from 2 to 12 reliefs per revolution of spindle (2 to 32 reliefs with Speed Reducer).

SPIRAL RELIEVING: Consists of radial relieving equipment plus additional gears required for helical teeth.

SIDE RELIEVING: A separate attachment which can be used in conjunction with the Radial Relieving Attachment if desired.

NOTE: When relieving attachments are used in combination a Speed Reducer is required.

Rests

Steady rest, oversize: Maximum capacity, 12" Lathe — $6\frac{1}{2}$ ";
16" Lathes — 9".

Follow rest: Maximum capacity, 12" Lathe — $2\frac{1}{4}$ ";
16" Lathes — 3".

Speed Reducer

Has built-in planetary gear train which gives a 6 to 1 reduction of spindle speed. This attachment permits cutting threads of very coarse pitches, is used extensively in conjunction with relieving attachments, and is employed on a wide variety of special work. It can also be used as an indexing face plate.

Step Chucks and Closers

$\frac{7}{8}$ " to $3\frac{1}{4}$ " capacity.

$\frac{7}{8}$ " to $6\frac{1}{2}$ " capacity.

$4\frac{1}{2}$ " capacity, with 4 adjustable jaws.

Closer for 4-jaw and $6\frac{1}{2}$ " capacity step chucks.

Closer for $3\frac{1}{4}$ " capacity step chuck.

Spindle bushing for step chucks.

*Draw-in sleeve (same as furnished with Collet Draw-back Attachment).

NOTE: The step chucks are steel blanks ready to be machined out to customer's requirements. Closers are of cast iron.

Ball Bearing Taper Attachment

Will turn, bore and thread up to 20° included angle (4" taper per foot); it can be clamped to the bed in any position within range of the tool carriage travel; it turns tapers up to 15" in length on the 12" Lathe and up to 18" on the 16" Lathes.

Tool Posts, Round

In addition to the tool post furnished as regular equipment.

Translating Gears

English to Metric or Metric to English.

The gears and charts are packed in a suitable cabinet.

*Same sleeve common to all such attachments.

Note: Unless otherwise designated, equipment listed above is available for both 12" and 16" lathes.

The description, illustrations and specifications in this circular are correct at the time of printing. Since the policy of Pratt & Whitney is constantly to improve its machines and equipment, we reserve the right to change the design and specifications of any product without notice.

Dependable PRECISION

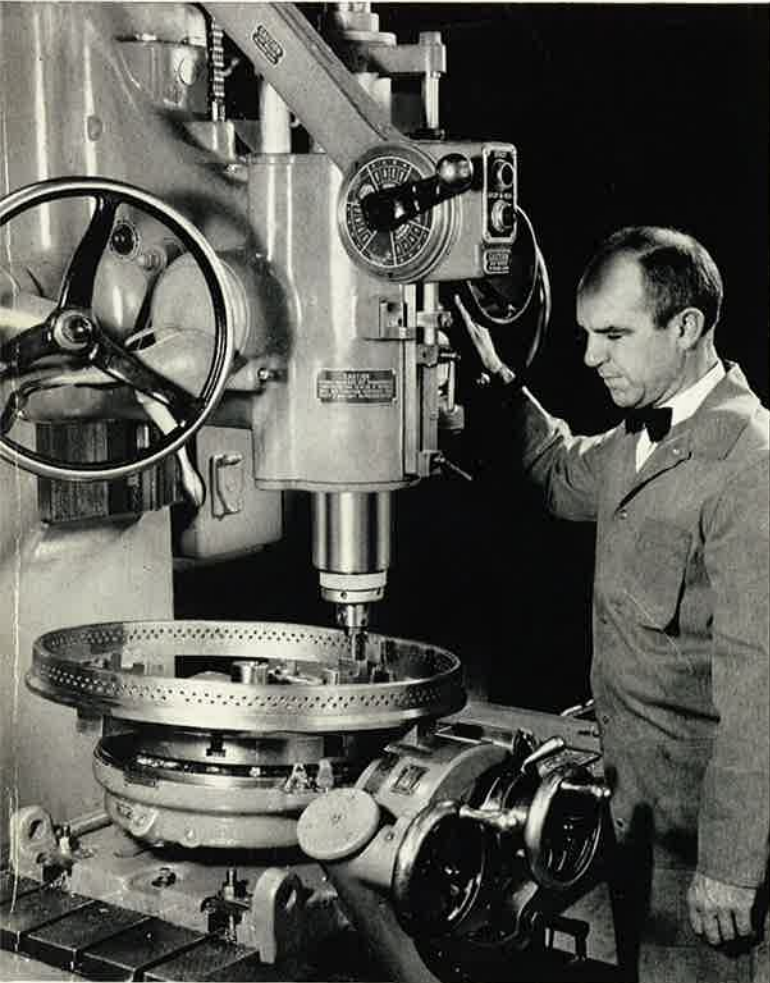

Pratt & Whitney Jig Borers, like the one above, do all the important precision boring work on jigs and fixtures. They have been standard tool room equipment since 1918 — and have always paid dividends.

THERE is no substitute for dependable precision. Too often the assembly line must correct faults and errors that would not exist if production had been accurate. That means trouble—and poor performance of your product later on.

Eliminating assembly troubles and inaccuracies is one of the greatest trials of production engineers. The best remedy is careful precision in the tool room. You cannot expect good tool makers to do precision work with inferior equipment. Your tool room deserves the best there is, because it is the precision center of your whole shop. That is why so many tool rooms come to Pratt & Whitney for equipment.

Pratt & Whitney precision machine tools, cutting tools and gages are built by master craftsmen. The precision built into these machines and tools is passed on to the products they turn out. That initial and lasting accuracy pays dividends that in turn more than justify the cost of this high grade equipment.

Modern precision machines in your tool room will get your tools finished on time without sacrificing accuracy. Give your tool men a chance with first class equipment, and watch your troubles smooth out.

PLANT ENGINEER
2037

PRATT & WHITNEY
DIVISION NILES-BEMENT-POND COMPANY

U B J UPTON BRADEEN & JAMES
LIMITED

BRANCH OFFICES . . . BIRMINGHAM
LOS ANGELES • NEW YORK • I

Montreal
Moncton

Machine Tools - Mill Supplies
Woodworking Machinery - Abrasives
Toronto - Ottawa - Winnipeg - Hamilton

Vancouver
Windsor

Co.) • DETROIT • HOUSTON (The Stanco Co.)
QUIS • EXPORT DEPT., WEST HARTFORD

MACHINE TOOLS • GAGES • CUTTING TOOLS

8-54-5H Circular 539-1

Printed in United States of America